

**EVALUATION AND REFINEMENT OF LOW COST AUTOMATION
SYSTEM FOR NATURALLY VENTILATED GREENHOUSE**

by

JINU A.

(2014-28-101)



Department of Soil and Water Conservation Engineering

KELAPPAJI COLLEGE OF AGRICULTURAL ENGINEERING AND TECHNOLOGY

TAVANUR, MALAPPURAM-679573

KERALA, INDIA

2019

**EVALUATION AND REFINEMENT OF LOW COST AUTOMATION SYSTEM
FOR NATURALLY VENTILATED GREENHOUSE**

by

JINU A.
(2014-28-101)

THESIS

Submitted in partial fulfillment of the requirement for the degree of

DOCTOR OF PHILOSOPHY

IN

AGRICULTURAL ENGINEERING

(Soil and Water Engineering)

Faculty of Agricultural Engineering and Technology

Kerala Agricultural University



Department of Soil and Water Conservation Engineering

KELAPPAJI COLLEGE OF AGRICULTURAL ENGINEERING AND TECHNOLOGY

TAVANUR, MALAPPURAM-679 573

KERALA, INDIA

2019

DECLARATION

I, hereby declare that this thesis entitled “**EVALUATION AND REFINEMENT OF LOW COST AUTOMATION SYSTEM FOR NATURALLY VENTILATED GREENHOUSE**” is a bonafide record of research work done by me during the course of research and the thesis has not previously formed the basis for the award to me of any degree, diploma, associateship, fellowship or other similar title, of any other University or Society.

Place: Tavanur

Date:

JINU A.

(2014-28-101)

CERTIFICATE

Certified that this thesis entitled “**EVALUATION AND REFINEMENT OF LOW COST AUTOMATION SYSTEM FOR NATURALLY VENTILATED GREENHOUSE**” is a record of research work done independently by **Mr. Jinu A. (2014-28-101)** under my guidance and supervision and that it has not previously formed the basis for the award of any degree, diploma, fellowship or associateship to him.

Tavanur,

Date:

Dr. Abdul Hakkim V.M.

(Major Advisor, Advisory Committee)

Professor (Soil and Water Engineering)

College of Agriculture, Padannakkad

(Kerala Agricultural University)

CERTIFICATE

We, the undersigned members of the advisory committee of Mr. Jinu A., a candidate for the degree of **Doctor of Philosophy in Agricultural Engineering**, with major in Soil and Water Engineering, agree that the thesis entitled **“EVALUATION AND REFINEMENT OF LOW COST AUTOMATION SYSTEM FOR NATURALLY VENTILATED GREENHOUSE”** may be submitted by Mr. Jinu A., in partial fulfillment of the requirement for the degree.

Dr. Abdul Hakkim V.M.

(Chairman, Advisory Committee)
Professor (Soil and Water Engineering)
College of Agriculture, Padannakkad
(Kerala Agricultural University)

Dr. Sathian K.K

(Member, Advisory Committee)
Dean (Agrl. Engg.) and
Professor & Head, Department of SWCE
KCAET, Tavanur

Dr. Kurien E.K..

(Member, Advisory Committee)
Professor & Head
ARS, Chalakkudy

Dr. Rema K.P.

(Member, Advisory Committee)
Professor
Department of Irrigation and Drainage
Engineering, KCAET, Tavanur

Dr. Berin Pathrose

(Member, Advisory Committee)
Assistant Professor
Department of Agricultural Entomology
College of Horticulture
Vellanikkara

EXTERNAL EXAMINER

ACKNOWLEDGEMENT

The thesis completed and appears in its current form due to the assistance and guidance of several people. I would consider this work nothing more than incomplete without attending to the task of acknowledging the overwhelming help I received during this endeavor. The completion of this Ph.D work would not have happened without the help and support from many people who contributed directly and indirectly to this venture. At this point of time, it is a pleasant task for me to express my thanks to all those who contributed in different ways to the success of this study and made it an unforgettable experience for me.

First and foremost, I bow my head before God Almighty for strengthening me throughout my life and enabling me to successfully complete the thesis work in time. I am deeply indebted to the Kerala Agricultural University for granting me study leave and providing me necessary financial and technical support for undergoing the Ph.D. programme.

It is with immense pleasure I avail this opportunity to express my sincere thanks and indebtedness to my Chairman **Dr. Abdul Hakkim, V.M.**, Professor, ARS, Anakkayam for untiring supervision, meticulous guidance and benevolent criticisms and constructive suggestions given during the period of research. The words of appreciation and the sense of freedom and support that I experienced while working under his guidance during the period of research work made me to achieve the goal well in time. It is my proud privilege to express my heartfelt indebtedness and deepest sense of gratitude for laying out the guidelines of research work. I have real admiration, gratitude and regards for his full hearted support and untiring help.

It is my pleasure to pay tribute to **Dr. Sathian, K.K.**, Dean and Professor & Head, Department of land and Water Resources & Conservation Engineering, K.C.A.E.T, Tavanur, and member of advisory committee for his advice and guidance rendered during this study.

I extend my sincere thanks to **Dr. Kurien E.K.**, Professor and Head, Agronomic Research Station, Chalakudy, **Dr. Rema K.P.**, Professor, Department of Irrigation and Drainage Engineering and **Dr. Berin Patrohose**; my Advisory Committee members for the constant support and valuable suggestions at the various stages of the formulation of the thesis.

I have boundless pleasure in recording my profound thanks to **Mr. Jubail**, Farm Manager, ARS Anakkayam for his expert advice, inspiring guidance, valuable suggestions, constructive criticisms, affectionate advice and above all, the extreme patience, understanding and whole hearted cooperation throughout the research work.

My sincere thanks to **Ms. Shahida**, Farm Manager, ARS Anakkayam for her valuable help during the research work. My special thanks to **Ms. Anjaly C. Sunny** for her valuable helps during the period of experiment.

I would fail my heart if I miss to thank **Mr. Subeesh T.P.**, Labour Anakkayam and **Mr. Muhammed Basheer M.**, Labour Anakkayam for their valuable support and helps for the successful conduct of the experiment in time. I am extremely thankful to all the laborers attached especially **Mr. P.K. Sundaran** for the helps during the experiment. My special thanks to all the staff of ARS Anakkayam for their support during the research work.

My sincere thanks to all the faculty members and staff who helped me for getting sanction of the study leave for the Ph D programme. My heartfelt thanks to **Kerala Agricultural University** for providing me study leave for undertaking this research work.

This dream came to a reality with the immense moral support, help and cooperation rendered by my family members. My special thanks for them.

I am extremely grateful to the all teachers, staffs of the KCAET, Tavanur for their sincere support.

I once again express my heartfelt thanks to all those who helped me in completing this venture in time.

Jinu A.

CONTENTS

Chapter No.	Title	Page No.
	LIST OF TABLES	
	LIST OF FIGURES	
	LIST OF PLATES	
	LIST OF APPENDICES	
	ABBREVIATIONS USED	
I	INTRODUCTION	1-5
II	REVIEW OF LITERATURE	6-40
III	MATERIALS AND METHODS	41-81
IV	RESULTS AND DISCUSSION	82- 195
V	SUMMARY AND CONCLUSION	196-200
	REFERENCES	i – xviii
	APPENDICES	xix – xxxiii
	ABSTRACT	

LIST OF TABLES

Table No.	Title	Page No.
3.1	Specifications of micro controller	46
3.2	Emergency messages displayed on the microcontroller	49
3.3	Specifications of exhaust fans	56
3.4	Specifications of Fertilizer Injection Pumps	63
3.5	Specifications of float switch	64
3.6	Discharge rate of fertilizer injector pumps during first crop season	68
3.7	Discharge rate of fertilizer injector pumps during second crop season	68
3.8	Discharge rate of fertilizer injector pumps during third crop season	68
3.9	Specification of the selected greenhouses	70
3.10	Requirement of water in fertilizer tanks	72
4.1	Hourly variation of temperature inside the greenhouse without crop	83
4.2	Hourly variation of RH inside the greenhouse without crop	84
4.3	Seasonal average of hourly temperature during first season inside AGH, NAGH and OGH	88
4.4	Seasonal average of hourly RH during first season inside AGH, NAGH and OGH	88
4.5	Mean value of temperature and RH from 10 am to 5 pm during 1 st season	88
4.6	Average temperatures during December 2015	89
4.7	Average RH during December 2015	91
4.8	Mean value of temperature and RH from 10 am to 5 pm during December 2015	91
4.9	Average temperature during January 2016	93
4.10	Average RH during January 2016	93
4.11	Mean value of temperature and RH from 10 am to 5 pm during January 2016	93
4.12	Average temperature during February 2016	97
4.13	Average RH during February 2016	97
4.14	Mean value of temperature and RH from 10 am to 5 pm during February 2016	97

4.15	Average temperatures during March 2016	100
4.16	Average RH during March 2016	100
4.17	Mean value of temperature and RH from 10 am to 5 pm during March 2016	100
4.18	Average temperature during second crop season	114
4.19	Average RH during second crop season	115
4.20	Mean value of temperature and RH from 10 am to 5 pm during second crop season	115
4.21	Average temperature during May 2016	118
4.22	Average RH during May 2016	118
4.23	Mean temperature and RH from 10 am to 5 pm during May2016	118
4.24	Average temperature during June 2016	120
4.25	Average RH during June 2016	120
4.26	Mean temperature and RH from 10 am to 5 pm during June 2016	120
4.27	Average temperature during July 2016	124
4.28	Average RH during July 2016	124
4.29	Mean temperature and RH from 10 am to 5 pm during July 2016	124
4.30	Average temperature inside the greenhouse during third crop season	138
4.31	Average RH during third crop season	138
4.32	Mean Temperature and RH from 10 am to 5 pm during third crop season	138
4.33	Average temperatures during November 2016	141
4.34	Average RH during November 2016	141
4.35	Mean values of temperature and RH from 10 am to 5 pm during November 2016	141
4.36	Average temperature during December 2016	144
4.37	Average RH during December 2016	144
4.38	Mean values of temperature and RH from 10 am to 5 pm during December 2016	144
4.39	Average temperature during January 2017	146
4.40	Average RH during January 2017	147
4.41	Mean values of temperature and RH from 10 am to 5 pm during January 2017	147

4.42	Average temperature during February 2017	149
4.43	Average RH during February 2017	149
4.44	Mean values of temperature and RH from 10 am to 5 pm during February 2017	150
4.45	Important dates during first crop season	164
4.46	Important dates during second crop season	165
4.47	Important dates during third crop season	165
4.48	Number of days required to first flower bud formation	166
4.49	Number of days required to first flower formation	167
4.50	Number of days required to 50% flowering	168
4.51	Number of days required to first fruit set	169
4.52	Number of days required to first harvest	170
4.53	Effect of different treatments on average height of plants for first crop	172
4.54	Effect of different treatment on average height of plants for second crop	173
4.55	Effect of different treatment on average height of plants for third crop	173
4.56	Number of leaves during first crop season	175
4.57	Number of leaves during second crop season	175
4.58	Number of leaves during third crop season	175
4.59	Effect of treatments on leaf length during first crop season	178
4.60	Effect of treatments on leaf length during second crop season	179
4.61	Effect of treatments on leaf length during third crop season	179
4.62	Effect of treatments on leaf width during first crop season	181
4.63	Effect of treatments on leaf width during second crop season	181
4.64	Effect of treatments on leaf width during third crop season	182
4.65	Effect of treatments on yield of cucumber	185
4.66	Effect of treatments on average length of fruits	187
4.67	Effect of treatments on average diameter of fruit	189
4.68	Effect of treatments on average weight of fruit	191
4.69	Effect of treatments on average of number of fruits per plant	193
4.70	Comparison of cost of cultivation	195

LIST OF FIGURES

Fig. No.	Title	Page No.
3.1	Logical circuits in the system	45
3.2	Connection diagram of the timer	60
4.1	Hourly variation of temperature inside the greenhouse without crop	85
4.2	Hourly variation of RH inside the greenhouse without crop	85
4.3	Hourly variation of seasonal average temperature	87
4.4	Hourly variation of seasonal average relative humidity	87
4.5	Hourly variation of temperatures during December 2015	90
4.6	Hourly variation of RH during December 2015	91
4.7	Hourly variation of temperature during January 2016	94
4.8	Hourly variation of RH during January 2016	94
4.9	Hourly variation of temperature during February 2016	96
4.10	Hourly variation of RH during February 2016	96
4.11	Hourly variation of temperature during March 2016	99
4.12	Hourly variation of RH during March 2016	99
4.13	Hourly variation of temperature during first week (1 st crop)	103
4.14	Hourly variation of temperature during second week (1 st crop)	103
4.15	Hourly variation of temperature during third week (1 st crop)	104
4.16	Hourly variation of temperature during fourth week (1 st crop)	104
4.17	Hourly variation of temperature during fifth week (1 st crop)	104
4.18	Hourly variation of temperature during sixth week (1 st crop)	105
4.19	Hourly variation of temperature during seventh week (1 st crop)	105
4.20	Hourly variation of temperature during eighth week (1 st crop)	105
4.21	Hourly variation of temperature during ninth week (1 st crop)	106
4.22	Hourly variation of temperature during tenth week (1 st crop)	106
4.23	Hourly variation of temperature during eleventh week (1 st crop)	106
4.24	Hourly variation of temperature during twelfth week (1 st crop)	107
4.25	Hourly variation of temperature during thirteenth week (1 st crop)	107
4.26	Hourly variation of RH during first week (1 st crop)	107
4.27	Hourly variation of RH during second week (1 st crop)	108
4.28	Hourly variation of RH during third week (1 st crop)	108
4.29	Hourly variation of RH during fourth week (1 st crop)	108

4.30	Hourly variation of RH during fifth week (1 st crop)	109
4.31	Hourly variation of RH during sixth week (1 st crop)	109
4.32	Hourly variation of RH during seventh week (1 st crop)	109
4.33	Hourly variation of RH during eighth week (1 st crop)	110
4.34	Hourly variation of RH during ninth week (1 st crop)	110
4.35	Hourly variation of RH during tenth week (1 st crop)	110
4.36	Hourly variation of RH during eleventh week (1 st crop)	111
4.37	Hourly variation of RH during twelfth week (1 st crop)	111
4.38	Hourly variation of RH during thirteenth week (1 st crop)	111
4.39	Hourly variation of temperature during second crop season	113
4.40	Hourly variation of RH during second crop season	114
4.41	Hourly variation of temperature during May 2016	117
4.42	Hourly variation of RH during May 2016	117
4.43	Hourly variation of average temperature during June 2016	121
4.44	hourly variation of average RH during June 2016	121
4.45	Hourly variation of temperature during July 2016	123
4.46	Hourly variation of RH during July 2016	123
4.47	Hourly variation of temperature during first week (2 nd crop)	126
4.48	Hourly variation of temperature during second week (2 nd crop)	126
4.49	Hourly variation of temperature during third week (2 nd crop)	127
4.50	Hourly variation of temperature during fourth week (2 nd crop)	127
4.51	Hourly variation of temperature during fifth week (2 nd crop)	127
4.52	Hourly variation of temperature during sixth week (2 nd crop)	128
4.53	Hourly variation of temperature during seventh week (2 nd crop)	128
4.54	Hourly variation of temperature during eighth week (2 nd crop)	128
4.55	Hourly variation of temperature during ninth week (2 nd crop)	129
4.56	Hourly variation of temperature during tenth week (2 nd crop)	129
4.57	Hourly variation of temperature during eleventh week (2 nd crop)	129
4.58	Hourly variation of temperature during twelfth week (2 nd crop)	130
4.59	Hourly variation of temperature during thirteenth week (2 nd crop)	130
4.60	Hourly variation of RH during first week (2 nd crop)	130
4.61	Hourly variation of RH during second week (2 nd crop)	131

4.62	Hourly variation of RH during third week (2 nd crop)	131
4.63	Hourly variation of RH during fourth week (2 nd crop)	131
4.64	Hourly variation of RH during fifth week (2 nd crop)	132
4.65	Hourly variation of RH during sixth week (2 nd crop)	132
4.66	Hourly variation of RH during seventh week (2 nd crop)	132
4.67	Hourly variation of RH during eighth week (2 nd crop)	133
4.68	Hourly variation of RH during ninth week (2 nd crop)	133
4.69	Hourly variation of RH during tenth week (2 nd crop)	133
4.70	Hourly variation of RH during eleventh week (2 nd crop)	134
4.71	Hourly variation of RH during twelfth week (2 nd crop)	134
4.72	Hourly variation of RH during thirteenth week (2 nd crop)	134
4.73	Hourly variation of temperature during third crop season	137
4.74	Hourly variation of RH during third crop season	137
4.75	Hourly variation of temperature during November 2016	140
4.76	Hourly variation of RH during November 2016	140
4.77	Hourly variation of temperature during December 2016	143
4.78	Hourly variation of RH during December 2016	143
4.79	Hourly variation of temperature during January 2017	146
4.80	Hourly variation of relative humidity during January 2017	147
4.81	Hourly variation of temperature during February 2017	150
4.82	Hourly variation of RH during February 2017	150
4.83	Hourly variation of temperature during first week (3 rd crop)	152
4.84	Hourly variation of temperature during second week (3 rd crop)	152
4.85	Hourly variation of temperature during third week (3 rd crop)	153
4.86	Hourly variation of temperature during fourth week (3 rd crop)	153
4.87	Hourly variation of temperature during fifth week (3 rd crop)	153
4.88	Hourly variation of temperature during sixth week (3 rd crop)	154
4.89	Hourly variation of temperature during seventh week (3 rd crop)	154
4.90	Hourly variation of temperature during eighth week (3 rd crop)	154
4.91	Hourly variation of temperature during ninth week (3 rd crop)	155
4.92	Hourly variation of temperature during tenth week (3 rd crop)	155
4.93	Hourly variation of temperature during eleventh week (3 rd crop)	155

4.94	Hourly variation of temperature during twelfth week (3 rd crop)	156
4.95	Hourly variation of temperature during thirteenth week (3 rd crop)	156
4.96	Hourly variation of RH during first week (3 rd crop)	156
4.97	Hourly variation of RH during second week (3 rd crop)	157
4.98	Hourly variation of RH during third week (3 rd crop)	157
4.99	Hourly variation of RH during fourth week (3 rd crop)	157
4.100	Hourly variation of RH during fifth week (3 rd crop)	158
4.101	Hourly variation of RH during sixth week (3 rd crop)	158
4.102	Hourly variation of RH during seventh week (3 rd crop)	158
4.103	Hourly variation of RH during eighth week (3 rd crop)	159
4.104	Hourly variation of RH during ninth week (3 rd crop)	159
4.105	Hourly variation of RH during tenth week (3 rd crop)	159
4.106	Hourly variation of RH during eleventh week (3 rd crop)	160
4.107	Hourly variation of RH during twelfth week (3 rd crop)	160
4.108	Hourly variation of RH during thirteenth week (3 rd crop)	160
4.109	Number of days required to first flower bud formation	166
4.110	Number of days required to first flower formation	167
4.111	Number of days required to 50% flowering	168
4.112	Number of days required to first fruit	169
4.113	Number of days required to first harvest	170
4.114	Effect automation on height of plant for first crop	173
4.115	Effect automation on height of plant for second crop	174
4.116	Effect automation on height of plant for third crop	174
4.117	Number of leaves during first crop season	176
4.118	Number of leaves during second crop season	176
4.119	Number of leaves during third crop season	176
4.120	Effect of treatments on leaf length during first crop season	179
4.121	Effect of treatments on leaf length during second crop season	180
4.122	Effect of treatments on leaf length during third crop season	180
4.123	Effect of treatments on leaf width during first crop season	182
4.124	Effect of treatments on leaf width during second crop season	183
4.125	Effect of treatments on leaf width during third crop season	183

4.126	Effect of treatments on yield of cucumber	186
4.127	Effect of treatments on average length of fruits	188
4.128	Effect of treatments on average diameter of fruit	190
4.129	Effect of treatments on average diameter of fruit	192
4.130	Effect of treatments on number of fruits per plant	194

LIST OF PLATES

Plate No.	Title	Page No.
1	Automation system enclosed in wooden casing (Closed position)	47
2	Wooden casing containing logical circuits	47
3	Side view of the wooden casing containing logical circuits	48
4	View of experimental greenhouse	48
5	Foggers in operation	59
6	Fertilizer tanks	59
7	Timer used for irrigation and fertigation automation	61
8	Solar panels	65
9	Exhaust fans	65
10	Sowing	76
11	Germination stage	76
12	Seedlings ready for transplanting	77
13	Transplanted seedlings	77
14	Bud initiation stage	78
15	Flowering stage	78
16	Harvesting stage	79
17	Harvested fruits (Left side Fruits from AGH and right side from NAGH)	79

LIST OF APPENDICES

Appendix. No.	Title	Page No.
I	Average Microclimate Data without Crop	xix
II	Average Microclimate Data during First Crop	xx
III	Average Microclimate Data during December 2015 (First Crop)	xxi
IV	Average Microclimate Data during January 2016 (First Crop)	xxii
V	Average Microclimate Data during February 2016 (First Crop)	xxiii
VI	Average Microclimate Data during March 2016 (First Crop)	xxiv
VII	Average Microclimate Data during Second Crop	xxv
VIII	Average Microclimate Data during May 2016 (Second Crop)	xxvi
IX	Average Microclimate Data during June 2016 (Second Crop)	xxvii
X	Average Microclimate Data during July 2016 (Second Crop)	xxviii
XI	Average Microclimate Data during Third Crop	xxix
XII	Average Microclimate Data during November 2016 (Third Crop)	xxx
XIII	Average Microclimate Data during December 2016 (Third Crop)	xxxi
XIV	Average Microclimate Data during January 2017 (Third Crop)	xxxii
XV	Average Microclimate Data during February 2017 (Third Crop)	xxxiii

SYMBOLS AND ABBREVIATIONS

ADC	Analogue to digital converter
AGH	Automated greenhouse
ARS	Agricultural Research Station
CAN	Controller area network
CFD	Computational Fluid Dynamics
EC	Electrical Conductivity
Etc.	Etcetera
ETHE-	Earth Tube Heat Exchanger
EU	European Union
FIP	Fertilizer Injection Pump
FPGA	Field Programmable Gate Array
GDP	Gross Domestic Product
GSM	Global system for mobile communication
HP	Horse Power
IC	Integrated circuit
IGS	Intelligent greenhouse systems
LCD	Liquid crystal display
LDR	Light dependent resistor
LED	Light emitting diode
MAP	Mono Ammonium Phosphate
NAGH	Non- automated greenhouse
NCEA	National Centre for Engineering in Agriculture
NIR	Near Infra Red

OGH	Outside the greenhouse
Pa	Pascal
PA	Precision Agriculture
PAR	Photosynthetically Active Radiation
PLD	Programmable logic devices
ppm	Parts per million
RH	Relative humidity
SMS	Short message service
SPA	Speaking plant approach
WSN	Wireless sensor network
⁰ C	Degree Celsius
%	Per cent

CHAPTER I

INTRODUCTION

Food security of the exponentially growing population can only be assured through the application of suitable technologies which can maximize agricultural production. The different factors which affect crop yield of a given genetic makeup include light, temperature, carbon dioxide concentration, relative humidity and nature of growing medium. In open field cultivation only the growing medium can be modified and the environmental factors which affect crop growth cannot be controlled. In greenhouses all the environmental parameters can be suitably controlled or modified. We can cultivate any crop at any place during any season inside the greenhouse by modifying crop growing environment.

Greenhouses are structures in which crop growing medium as well as crop growing environment can be modified according to the requirement of the crop. Greenhouse cultivation can become successful if new technologies in electronics such as automation for climatic control, irrigation and fertigation are adopted. One of the reasons for less income from farming is the lowest price of their produce during the normal growing season, whereas the cost of the agricultural produces will be high during offseason. Growth and yield of plants depend on the fertilizers, quality and genetic potential of seeds, pest and disease control and the desirable environmental parameters of the crop. The different environmental factors such as temperature, relative humidity, carbon dioxide concentration, air velocity, etc. can influence crop yield. Modifications of these environmental parameters are required for getting better production from crop. Each crop has a particular temperature range in which the crop growth and yield will be maximum. The movement of minerals, water and food in leaves, stems and roots will be adversely affected if the temperature is not optimum, which in turn affects photosynthesis of plants. Soil temperature also has its own effect on crop growth.

Relative humidity is another important parameter which affects the metabolic activities and photosynthesis of plants. Every crop has its relative

humidity range in which the growth and yield will be maximum. If the relative humidity is less, the evapotranspiration will be more and hence the water requirement will be high. On the other hand, if the relative humidity is very high then the pest and disease incidence will be higher. Hence it is necessary to maintain optimum relative humidity range to get maximum crop production. Concentration of carbon dioxide affects the plant growth because it is essential for photosynthesis. Carbon dioxide requirement is different for different type and stage of plant and in open field cultivation, there is no limitation of carbon dioxide concentration. But in closed structures, required concentration of carbon dioxide is to be assured for better plant growth. If the carbon dioxide concentration is 1000-1500 ppm, then the yield will be increased by 20-30 per cent (Salokhe and Sharma, 2012). Light intensity has direct effect on the performance of plant growth and yield. Visible spectrum of light is the energy source of plants for photosynthesis. Using carbon dioxide and water, plants produce carbohydrate and oxygen during photosynthesis using light energy. The carbohydrate thus produced contains stored light energy in it and this energy is used for all other activities of plants. Hence the intensity of light is an important parameter in deciding the yield of plants. Optimum intensity of light for most of the plants is 32000 lux (Salokhe and Sharma, 2012). Air movement has its own influence on plant growth because it affects the carbon dioxide level and evapotranspiration.

Greenhouse crop production is based on a controlled environment to provide the necessary conditions that are most favourable for maximum crop yield. Optimization of the greenhouse environment is achieved by controlling atmospheric as well as soil factors to the required level of the particular crop. Atmospheric parameters include air temperature, solar radiation, relative humidity, air composition and air velocity. Soil parameters include soil temperature, soil moisture, soil pH, nutrient status and soil physical, chemical and biological parameters. Because of the properties of the cladding material used, the temperature inside the greenhouse will be higher than outside. Reduction of temperature inside the greenhouse is a difficult task in protected cultivation.

There are different methods of greenhouse cooling such as roof shading, natural ventilation, forced ventilation, maintaining water film on greenhouse cover, earth air heat exchangers and evaporative cooling. Air conditioning is not usually used for greenhouse cooling because of higher cost for establishment and operation of the system.

Evaporative cooling is the most commonly used method of greenhouse cooling. The principle behind evaporative cooling is the conversion of sensible heat into the latent heat during evaporation of water and temperature inside the greenhouse is thus reduced. Fan and pad cooling system and mist / fog cooling system are the two commonly used evaporative cooling systems. Evaporative cooling is very effective in areas where low relative humidity exists. Greenhouse temperature is very high during peak hours of the day (11 AM to 4 PM) and during that time relative humidity will be less and evaporative cooling will work effectively inside the greenhouse. Fan and pad cooling system can be used only in hermetic greenhouses. If there is any air vent, then fan and pad system will become a failure. In naturally ventilated greenhouses mist/ fog system is used for evaporative cooling.

Greenhouse environmental conditions are managed by manual or automatic control system which comprises measurement, data processing, recording and management of environmental parameters. Development of a low cost automation system for greenhouse, which can operate with minimum human intervention, accurately maintain its set points, able to learn and adjust itself have been some of the very obvious interests to fulfill economic, environmental, market, industrial and human preference needs. (Jinu and Hakkim 2016).

Kerala state falls under humid tropic climate condition and after the rainy season, there is need of greenhouse cooling. Most of the greenhouses are naturally ventilated because it is the low cost technology for greenhouse cooling. When the heat load is very high then evaporative cooling is required to maintain the greenhouse temperature. Mist or foggers are the devices used in naturally

ventilated greenhouses for evaporative cooling. While operating the evaporative cooling system, the relative humidity inside the greenhouse will be increased and the system is to be switched off when the relative humidity increases above the tolerable limit of crop. Higher humidity level in the greenhouse increase disease incidence also. Hence while managing temperature using evaporative cooling; care should be taken not to exceed the relative humidity more than maximum tolerable limit of crop inside it.

Drip irrigation is the common method of irrigation used in greenhouses and precise application of fertilizer can be done using fertigation. There are several advantages for fertigation compared to manual fertilizer application. Management of greenhouse microclimate, drip irrigation and fertigation are the regular activities to be performed in greenhouses. Manual operation of these activities are time consuming and laborious. Hence an automation system is necessary to manage greenhouse for better greenhouse cultivation (Hussain *et al.*, 2013). Greenhouse automation system consists of various sensors for collecting information about greenhouse parameters, a control device for receiving information and operating various actuators based on preset values through relays and various actuators for greenhouse environment control, irrigation and fertigation (Mohanty and Patil, 2013). Various sensors used include sensors for air temperature, soil temperature, relative humidity, light intensity, air velocity etc. and control devices are microprocessors or computers. Microprocessors are minicomputers used for automation of greenhouse and different types of microcontrollers are available. Depending upon the parameters to be controlled, the type of microcontroller can be selected. The actuators are the devices for the control of irrigation and fertigation and microclimate control devices such as foggers, exhaust fans, artificial lighting system, carbon dioxide enrichment system, etc. (Dele *et al.* 2013, Radojevic *et al.* 2014 and Schmidt, 2015).

Kerala is a state with very high labour cost and manual operation of climate control devices and irrigation and fertigation are time and labour consuming. Accurate management of greenhouse climate is not possible

manually; hence automation systems are better for greenhouse management. As the automation systems available in the market are very costly, which is not affordable to farmers, a low cost automation system is need of the hour. At Agricultural Research Station (ARS), Anakkayam a low cost automation system was developed, which has some limitations, as it could not manage the temperature and relative humidity simultaneously. This leads to build up of the excess humidity inside the greenhouse. Another limitation was that it could not manage irrigation and fertigation. Present study was undertaken to refine the existing system after evaluating its limitations to make it capable of managing temperature and relative humidity separately and to perform irrigation and fertigation operations. The refined automation system was tested during three crop seasons growing salad cucumber crop (variety Saniya) inside the greenhouse. The experiment was conducted inside a naturally ventilated greenhouse situated at the ARS, Anakkayam, under Kerala Agricultural University.

Objectives

- 1.To refine the low cost automation system suiting to the specific requirements.
- 2.To study the performance of the automated temperature control system inside the greenhouse.
- 3.To study the performance of automated relative humidity control system inside the greenhouse.
4. To study the performance of automated irrigation system inside the greenhouse.

CHAPTER II

REVIEW OF LITERATURE

Greenhouse is a protected cultivation structure which is used for protection of plants from wind, precipitation, excess solar radiation, temperature extremes, pests and diseases, etc. Green house is a structure made primarily of glass or sheets of clear plastics, in which crop growing environment as well as crop growing medium can be modified for the cultivation of plants. Greenhouse can also be defined as the sophisticated structure providing ideal conditions for satisfactory plant growth and production throughout the year.

Advantages of greenhouses include (Attavar, 1997),

- a) Maximum production from unit area.
- b) Depending upon market demand, any crop can be cultivated at any place during any season.
- c) Greenhouse cultivation increases the intensity of cropping.
- d) Cultivation is possible in problematic regions.
- e) Excellent quality vegetables, fruits and flowers can be produced.
- f) Greenhouse protects plants from pests and diseases.
- g) Greenhouse can also be used as a storage structure or can be used as a drier.

Irrigation is an important activity in crop production. The growth and yield of crops depend on the timely application of water and nutrients. Application of water and nutrients of required quantity at the specified interval is necessary for maximum production. Manual application of water and nutrients at timely intervals and correct dosage is very much labour and time consuming. Application of water through drip irrigation and nutrients through fertigation increases yield as well as saves time and labour for irrigation and fertilizer application (Varghese *et al.* 2014).

2.1 MICROCLIMATE CONTROL IN GREENHOUSES

Greenhouse microclimate is different from that of outside due to the presence of covering material. Environmental parameters inside the greenhouse such as temperature, relative humidity, solar radiation, air velocity and carbon dioxide concentration are different than that of outside due to the effect of covering material. All these factors have its own impact on quality and quantity of crop production. So these microclimatic factors are to be controlled based on the crop to attain maximum production(Salokhe and Sharma, 2012).

2.1.1 Light

Light has very important role in greenhouse cultivation because processes such as photosynthesis, transpiration, phase transition and morphology depend on it. The growth and production of plants is directly related to photosynthesis and if the light intensity is less, this will lead to minimum production. The rate of transpiration is also based on light intensity because light intensity also has direct effect on opening and closure of stomata and thus transpiration is also affected. So, to maximize production, light intensity and duration is assured based on the requirement of crop(Salokhe and Sharma, 2012).

2.1.2 Temperature

Each crop has its own range of temperature in which maximum growth and production can be obtained. Temperature has its own influence on initiation and development of reproductive phase. So the temperature manipulation has very much importance in ensuring maximum production from greenhouse. Flowering is initiated at a certain temperature range and if temperature is above or below that range, flowering is affected and as a result the yield will be less. So, based on the crop to be cultivated, the required temperature is to be provided using temperature manipulation measures. If the ambient temperature is very less, it is very easy to increase temperature inside the greenhouse by providing artificial heating measures. But, on the other hand, if the outside temperature is high, corresponding inside temperature will be very high and we have to adopt different

greenhouse cooling measures to decrease the greenhouse temperature(Manohar and Igathinathen, 2012).

2.1.3 Relative Humidity

Relative humidity inside the greenhouse is more than that of ambient climate due to the presence of cladding material. Increased temperature inside the greenhouse and the ventilation provided decreases the relative humidity to some extent. The required level of relative humidity inside the greenhouse is to be maintained scientifically. Every crop has its own optimum relative humidity range. If the relative humidity is less than that of optimum, artificial methods are to be adopted to increase it. On the other hand, if it is high, techniques are to be adopted to decrease the relative humidity inside the greenhouse. For increasing relative humidity, any of the evaporative cooling methods can be used. If the relative humidity is higher than that of permissible limit, then it can be decreased by ventilation, chemical dehumidification and cooling coils. The desirable range of relative humidity for most of the crops is between 50 to 80%. But in the case of plant propagation works, relative humidity up to 90% can be used.(Manohar and Igathinathen, 2012).

2.1.4 Carbon Dioxide

Another important microclimatic parameter inside the greenhouse which affects crop production is the carbon dioxide concentration, because carbon dioxide is the source of carbon which is an essential plant nutrient for plants. Concentration of carbon dioxide in atmosphere is 0.03% (345ppm). In the case of hermetic greenhouses there is no air exchange between inside and outside of greenhouse and as the crop uses carbon dioxide for photosynthesis, its concentration inside the greenhouse decreases. If additional amount of carbon dioxide is not supplied, then the photosynthesis of plants will be retarded or even stopped. For increasing the level of carbon dioxide inside the greenhouse, we can provide ventilators or can be increased by means of artificial techniques. Required range of carbon dioxide varies depends upon many factors such as crop,

light intensity, temperature, nutrient level and degree of maturity. For most of the crops, photosynthesis increases carbon dioxide concentration level up to 1200ppm (Manohar and Igathinathen, 2012).

2.2 GREENHOUSE COOLING

Temperature inside the greenhouse is to be maintained at required optimum level for better crop production. If the ambient climate is cold, it is easy to maintain the greenhouse temperature using heating methods. On the other hand if the outside climate is very hot, then the greenhouse temperature will be very much higher. In this case inside temperature has to be reduced and this is one of the major problem faced by greenhouse growers. Reducing the temperature inside the greenhouse is very difficult and expensive than heating. There are different techniques for greenhouse cooling. They include

- a) Roof shading by different means
- b) Natural ventilation using roof and side ventilators
- c) Forced ventilation
- d) Maintaining water film on greenhouse cover
- e) Earth air heat exchangers
- f) Evaporative cooling

Greenhouses can be cooled by any of the above method or it can be cooled by air conditioning system. But the cooling load inside the greenhouse will be very higher and hence it is not economical to use this for greenhouse cooling. So in most of the cases different evaporative cooling methods along with ventilation and other methods are used for greenhouse cooling.

Ventilation is the process of exchanging air inside the greenhouse with the outside air. Ventilation is required to remove surplus solar heat, evaporated and transpired water vapour and for supply of carbon dioxide. Ventilation rate is the volume of air exchange per unit of time per unit floor area. Sixty air changes per hour is necessary to avoid heating above the outside air temperature.

As water evaporates heat is absorbed and this is the principle of evaporative cooling. The degree of cooling obtained from an evaporative cooling system is directly related to the wet bulb depression that occurs with a given set of climatic conditions. The evaporative cooling systems used in greenhouses are fan and pad system and mist or fog system. Evaporative cooling systems are more effective in areas where low humidity exists. Generally the lowest humidity occurs during the hottest part of the day and at that time the greatest degree of cooling is required and evaporative cooling is more effective. During night, relative humidity increases and temperature decreases. The efficiency of evaporative cooling is at its lowest during the night.

Fan and pad system is a mode of evaporative cooling in which the warm air from greenhouse is removed by the exhaust fans and the cool air is brought in through the wetted pads placed vertically along one wall of the greenhouse. Water is allowed to pass through the pads when exhaust fans are working for the operation of the system. The area of pads provided has a greater effect of cooling.

In ventilation system, the movement of inside air takes place due to pressure difference created by wind or temperature gradients. White and Aldrich (1975) recommended that total area of ventilators should be 15-30% of floor area of the greenhouse. They found that above 30%, the effect of providing additional area of vents caused marginal improvement in performance.

According to Kozai and Sase (1978) for outside wind velocities less than 2m/s, the number of air changes mainly dependent upon the inside to outside temperature difference and above 2m/s, the number of air changes proportional to wind speed.

Bakker (1984) reported that, as ventilation area increased from 0 to 60% for a cucumber cultivated greenhouse, water vapour transport by ventilation increased from 1 to 28g/m²/min and transpiration increased from 3 to 12g/m²/min.

This shows that there is close relation between water vapour transport and transpiration.

The amount of solar radiant energy entering the greenhouse can be reduced by providing shade over the greenhouse cover or by applying opaque materials directly over the greenhouse cover. Commercial shading compounds or mixtures prepared with paint pigments are preferred for this purpose. White compounds are preferred as they reflect maximum amount of sunlight. Shading compound are less effective than shade covers. Shading compounds reflects most of the radiant energy, but some of it is absorbed and transmitted in to the greenhouse by conduction, but for the lath shades, air circulates between laths and cover and hence it provides more cooling. Another method of shading is to install curtains of various cloth materials on the greenhouse (Rajinder, 1985).

When high ventilation rates are required, then forced ventilation will be used to exchange air from greenhouse to outside. Forced ventilation is of two types

- Ventilation fans for air exchange (most commonly used)
- Fans for internal air mixing to improve air temperature uniformity and to keep the carbon dioxide concentration within dense plant canopies up to the ambient level.

Adequate air flow is the first requirement for any cooling system. It is a good practice to arrange the fan system to operate in two to four stages so that air flow can be matched to the cooling requirement at any given time. With exhaust fans, temperature within a fully cropped greenhouse will not exceed more than three to five degrees than that of outside (Mears, 1991).

Roof evaporative cooling is a technique in which water is circulated on the roof surface resulting in the formation of a water film. This water film helps to lower the sensible heat gain of the greenhouse air, thereby reducing its

temperature. The method is advantageous as it does not increase the relative humidity of inside air as encountered with fan-pad or fogging systems. Thus, this method of cooling reduces the chance of growth of microorganisms inside a greenhouse which is a common problem for greenhouses in humid tropics.

Earth-air heat exchangers utilize the nearly constant sub surface temperature profile of the earth to maintain a fairly uniform inside air temperature in a greenhouse. While the ambient temperature varies widely over the climatic cycle, the sub surface temperature of the earth tunnels usually remains in the range 26-28°C. In summer, warm air (ambient air or re-circulated air from greenhouse) is passed through buried pipes where its heat is dissipated to the underground soil.

Fog/mist evaporative cooling system uses high pressure pumping apparatus to produce extremely fine mist, allowing essentially a fog that tends to remain in the air. Evaporative cooling occurs above the crop with minimal wetting of foliage. A heavy fog also reduces solar intensity. Such a system is expensive, requires heavy pumps, pipe fittings, special nozzles and very clean water and it has a high electrical consumption. Ultra-fine droplets of water fill the greenhouse atmosphere and cool the greenhouse as water evaporates. Main advantage of fog system compared to fan and pad systems are the uniformity of conditions throughout the greenhouse and it can lower the greenhouse temperature to wet bulb temperature (Montero and Anton 1994).

Sutar and Tiwari (1995) carried an experimental study in a polyethylene covered even span greenhouse, where water was circulated on the roof. A temperature reduction of 4-5°C was achieved compared to the control greenhouse. When a shade cloth was put on the roof, along with water circulation, the inside air temperature reduced by 10°C compared to the control greenhouse.

Papadakis *et al.* (1996) reported that air exchange rate depends on wind velocity and ventilator opening area and not on wind direction. Presence of crop decreases ventilation efficiency (Boulard *et al.*, 1997). Effect of humidity on air exchange is less compared to temperature (Albright, 1997).

Boulard *et al.* (1997) studied the air flow and associated sensible heat exchange in a naturally ventilated twin span greenhouse having continuous roof vent at gutter using a three dimensional sonic anemometer. Results of the study showed that mean and turbulent components of sensible heat flux through the vent amounted to 58% and 42% of the total exchange between the greenhouse and environment. The study also revealed that stack effect is predominant only at low wind speed.

Fuchs *et al.* (1997) studied the energy balance in a greenhouse having bare soil with four different ventilation arrangements. They observed that external wind speed and internal buoyancy forces affected passive ventilation, but had no significant effect on fan induced ventilation. High ventilation rates diminished soil heat flux, increased sensible heat flux and marginally reduced the latent heat flux.

Willits and Peet (2000) conducted an experiment where water was applied intermittently to an externally mounted shade cloth. The results revealed that rise in air temperature reduced by 41% under wet cloth and 18% under dry cloth compared to an unshaded greenhouse.

Bailliet *et al.* (2001) studied the influence of whitening a greenhouse roof on microclimate and canopy behavior during summer in a greenhouse located in the coastal area of eastern Greece. The study revealed that whitening the greenhouse roof reduced the average greenhouse transmission coefficient for solar radiation due to which air temperature and vapour pressure deficit changed drastically, while the increase in rate of transpiration was marginal.

Katsoulaset *al.* (2001) studied the effect of misting on rose canopy transpiration and water vapour conductance for a greenhouse located in coastal area of Greece. They found that only 40-50% of the misting water was effectively used for the purpose of cooling. They also calculated the crop water stress index and observed that the crops were less stressed under in conditions of misting.

Teitel(2001) conducted experiments to study the effect of insect proof screen provided in roof openings on the microclimate of a naturally ventilated greenhouse. The study revealed that fine mesh screen caused obstruction to airflow resulting in higher temperature and humidity level inside a greenhouse.

Jain and Tiwari(2002) carried out theoretical and experimental studies in a greenhouse equipped with fan pad evaporative cooling. They reported that the inside air temperature was 4-5°C lower than that of ambient. They also attempted optimization of some greenhouse parameters.

Arbel *et al.* (2003) conducted an experimental study where fogging system was used in combination with forced ventilation for cooling a ridge type greenhouse. The results revealed that, inside the greenhouse an air temperature of 28°C and relative humidity of 80% could be maintained during the midday of summer. The arrangement provided uniformity in temperature and humidity inside the greenhouse along the length and vertical direction.

Fatnassiet *al.* (2003) simulated the temperature, humidity and air flow pattern in a large scale Moroccan greenhouse fitted with insect proof net using CFD software. The results predicted by the CFD model were validated through experiments. The study revealed that significant increase in temperature and humidity take place inside a greenhouse due to presence of insect proof net.

Ghosalet *al.* (2003) developed a mathematical model to study the effectiveness of cooling inside a greenhouse having shade cloth stretched over the roofs and south wall with water flowing it. The results predicted by the model were validated through experiments. The study revealed that greenhouse inside temperature reduced by 6°C and 2°C respectively in shaded with water flow and water flow condition compared to un-shaded condition.

Kittaset *al.* (2003) developed and experimentally validated a thermal model to predict the temperature gradient along the length of a large the greenhouse (60 m length) equipped with fan pad ventilation system. The thermal model incorporated the effects of ventilation rate, roof shading and crop transpiration. The study showed that large temperature gradients up to 8°C were generated from pad end to fan end due to significant length of the greenhouse.

Willits (2003) developed a thermal model to predict the microclimate inside a greenhouse having provisions of both fan induced ventilation and fan pad evaporative cooling system. The results of the model showed that when fans were alone put into use, little advantage could be obtained by increasing air flow rates beyond $0.05 \text{ m}^3 \text{ m}^{-2} \text{ s}^{-1}$. But, when evaporative cooling (fan-pad system) was employed, both air and canopy temperatures reduced with increase in air flow rates till $0.13 \text{ m}^3 \text{ m}^{-2} \text{ s}^{-1}$.

Ghosal *et al.* (2004) developed an analytical model to determine the year round effectiveness of a recirculation type earth air heat exchanger coupled with a greenhouse. Results predicted by the model were validated through experiments. The greenhouse air temperature was 3-4°C lower compared to the same greenhouse operated without earth air heat exchanger.

Ajwang and Tantau(2005) reported that the presence of an anti-thrips screen with discharge coefficient of 0.22, temperature inside a greenhouse was 5°C higher than that of ambient when young plants with low transpiration rate

was cultivated. Increase in temperature reduced to 3°C in the same greenhouse, when mature crop was grown under humid tropical climate.

Ghosal and Tiwari (2006) developed a thermal model to investigate the temperature inside a greenhouse having an integrated earth air heat exchanger. The study revealed that the inside air temperature of such a greenhouse could be maintained at a level which is 5-6°C lower than what could be maintained without earth-air heat exchanger.

Kittaset *et al.* (2006) studied the effect of two ultraviolet absorbing greenhouse cover on growth and yield of an eggplant soilless crop. The study showed that the eggplants grown inside a greenhouse having 0% transmission to Ultraviolet (UV) light were about 21% taller with 17% higher leaf product than plants cultivated in a greenhouse having 5% transmission to UV light.

Toida *et al.* (2006) developed and tested a method to enhance fog evaporative cooling system. The aim of their experiment was to solve the problem of wetting of the foliage during operation of fogging system and the low evaporation ratio (ratio of evaporated fog to generated fog) of the conventional fogging system. They tested three different nozzle positions. First one a vertically installed nozzle with two small fans (100mmX100mm) to provide an upward air stream for enhancing fog evaporation. Second one was a vertical nozzle without fan and third one was horizontal nozzle without fan. The downward movement of fog with air was observed by an image enhancing camera. The nozzle with fans provided a 1.5 times better evaporation ratio and three times wider cooling area than did the nozzle without fans under similar conditions. The nozzle with fans produced a lower and more uniform air temperature. The system employing a nozzle with small fans can achieve a higher evaporation ratio, resulting in an increased greenhouse cooling efficiency and a decreased possibility of pathogen expansion. Installation of the upright nozzle with an upward air stream by using small fans contributed to better fog evaporation because the fog was spread over a wider area.

Ganguly and Ghosh (2007) presented a thermal model of a greenhouse having fan pad evaporative cooling system and compared the results of the thermal model with a reference study in literature. They concluded that a temperature reduction of 6°C can be achieved with fan pad evaporative cooling and shading during peak sunshine hours for a representative day in April in a place like Kolkata (India) that represents a mixed climate of coastal and plain areas.

Sethi and Sharma (2007) designed and developed an aquifer-coupled cavity flow heat exchanger system (ACCFHES) for cooling and heating of an agricultural greenhouse established at Chandigarh, India. Results of their studies revealed that, under extreme summer condition, the integration of ACCFHES with greenhouse helps in maintaining inside air temperature 6-7°C below that of ambient.

Li and Willits (2008) compared the cooling performance of a low and high pressure fogging system for naturally ventilated greenhouses. The study revealed that on an average, the evaporation efficiency of the high pressure fogging system was at least 64% higher than the low pressure system. Also, the cooling efficiency for the high pressure of fogging system was at least 28% more than the low of pressure fogging system.

Mutwiwaet *al.* (2008) investigated the effect of NIR reflecting pigments on microclimate of naturally ventilated greenhouses. The results revealed that use of NIR reflecting pigment in naturally ventilated greenhouses can help to achieve cooling in areas having high ambient relative humidity.

Sharan (2010) studied the effect of earth tube heat exchanger (ETHE) along with provision for shading, natural ventilation and mist nozzles for

greenhouse climatic control with tomato crop cultivated inside the greenhouse. They reported that ETHE has good effect in controlling greenhouse temperature inside the greenhouse. Inside temperature is only 2-3 °C greater than that of ambient temperature if it is used along with shading. This also helps in increase of inside temperature during cold nights.

Sonneveld *et al.* (2010) investigated greenhouse covering materials that could separate PAR and NIR components of solar radiation. Only the PAR component was allowed to enter into the greenhouse and NIR part (that contains half of the solar energy) was reflected back. The reflection of NIR resulted in reduction of thermal load inside the greenhouse without affecting the rate of photosynthesis.

Grubber *et al.* (2011) developed a non linear model predictive control for the operation of natural ventilation. The test results found that the temperature inside the greenhouse was well managed by this system.

Abbouda and Almuhanha (2012) developed and tested an improved evaporative cooling system. In their experiment they used a cooling coil unit in addition to the fan pad cooling system. Cooling coil unit utilized as pre-cooler systems to decrease temperature of hot air. This unit decreased the dry and wet bulb temperature of the air and this air was passed through the wet pad and gone through the exhaust fans after cooling the greenhouse air. Thus this combined greenhouse cooling system is more effective than the ordinary fan and pad cooling system. The results revealed that cooling coil unit decreased the air temperature by 9.4°C during daytime and by 6.1°C during night time. Combined cooling system lowers greenhouse temperature by 19.1°C during daytime and 9°C during nighttime than that of outside temperature.

Baeza *et al.* (2012) reported that air exchange rates per unit ground area were highest when the distance between sidewalls equipped with vents was small.

Anand Zambre (2013) reported that whitewashing the covering film reduces the intensity of light inside the greenhouse and also reduces the life of covering material. Use of diffused lights is better than whitewashing the covering material. By incorporating special fillers in the polymer, this type of films can be manufactured. These films will not cause much hindrance to the total light transmission and also gives diffused light in greenhouse. The shadow effect is not seen while using this type of film. Sun burn and scorching can be avoided by using this type of film. If UV rays are fully prevented in greenhouse, vision of the insects is affected and their attack can be prevented. If infrared rays are reflected, then heat load inside the greenhouse can be reduced. From the results it is revealed that application of shade net over the greenhouse reduces the entry of Photo synthetically Active Radiation (PAR), which is vital for plants to carry out photosynthesis. Thus, the future work in this direction should be directed towards development of new covering materials and reflecting pigments that will allow only PAR component of solar radiation to enter the greenhouse during the day and reflect back the NIR. This will reduce the sensible heat gain of greenhouse air without affecting the rate of photosynthesis.

Coomans et al (2013) conducted study on greenhouse ventilation to reduce the energy consumption. They compared natural ventilation and forced ventilation. Test results found that naturally ventilated greenhouse gives energy saving of 13%.

Franco *et al.* (2014) tested the energy efficiency of evaporative cooling boxes and cellulose pads which were used for greenhouse cooling. Evaporative cooling boxes are the alternative cooling systems that can be used for non – hermetic greenhouses. In the case of non hermetic greenhouses, the cooling method usually used is mist/fog cooling systems. But, because of the problems created due to wetting of foliage, its use is limited. Fan and pad cooling system has the limitation that the greenhouse is to be hermetic. Moreover, in a fan and pad cooled greenhouse, the increased humidity remains there if the fan is not

working continuously and this leads to more consumption of electricity. The results obtained show that the plastic packing in the cooling unit produces a pressure drop of 11.05 Pa at $2 \text{ m}\cdot\text{s}^{-1}$, which is between 51.27% and 94.87% lower than that produced by the cellulose pads. This pressure drop was not influenced by increases in the water flow. The evaporative cooling boxes presented greater saturation efficiency at the same flow, namely 82.63%, as opposed to an average figure of 65% for the cellulose pads and also had a lower specific consumption of water, at around $3.05 \text{ L}\cdot\text{h}^{-1}\cdot\text{m}^{-2}\cdot^{\circ}\text{C}^{-1}$.

Adarsh *et al.* (2017) developed and tested evaporative cooling box to reduce temperature inside the greenhouse. Three types of evaporative cooling boxes were made and the performance of these boxes was tested inside a naturally ventilated greenhouse at KCAET, Tavanur. The temperature reduction by three boxes were 5.34°C , 3.4°C and 4.5°C respectively.

Atia and El-Madany (2017) conducted study on temperature control inside the greenhouse using automatic management of ventilation. They developed and tested adaptative neuro – fuzzy inference system for automatic control and reported that the system was capable of managing temperature inside the greenhouse through ventilation.

2.3 DRIP IRRIGATION

There are different water application methods for crops, out of which drip irrigation is the most efficient method. Required rate of water can be applied at the root zone of the crop by drip emitter in this type of irrigation. Different types of drip emitters are available and depending upon the water requirement of crop, the type and number of emitters can be selected. Water can be applied at slow rate above or below the surface of the soil in drip irrigation and water loss through evaporation, runoff, seepage, etc. are less in case of drip irrigation. Weed growth is less in drip irrigated fields. Hence the yield of crop will be more in drip irrigated field compared to other methods of irrigation (Michael, 1994).

Singh *et al.*(2000) studied the efficiency of drip irrigation for the crop of apricot. They compared the growth and yield of apricot irrigated by drip and conventional method of irrigation. The study resulted that drip irrigation is better than other methods of irrigation.

Drip irrigation consumes less amount of water compared to other methods. Hence this method can be treated as a method to conserve water resources. It can save 40 to 70 percentage of water compared to other methods of irrigation (Ashokaraja and Kumar, 2001).

Jain *et al.* (2001) conducted study on the efficiency of drip irrigation for potato crop. The study proved that drip irrigation with plastic mulching gives 80 % efficiency.

Narayanamoorthy (2001) compared drip irrigation and flood irrigation in his study. It was found that drip irrigation is more beneficial than the other method.

Singh *et al.* (2001) compared the performance of litchi in drip irrigated field and field where surface irrigation was followed. Test proved that drip irrigation is better than surface irrigation. In case of drip irrigated field cost benefit ratio was 3.91 and in case of surface irrigated field, it was 3.05.

Drip irrigation can be done in undulating field and it does not cause damage to soil structure. Foliage diseases are less in drip irrigated field compared to other fields. Moreover fertigation and automation is possible in the case of drip irrigation (Hochmuth and Smajestrila, 2003).

Singhandhubeet *al.* (2003) compared the urea uptake of crops in drip irrigation and furrow irrigation. It was found that 20 to 40% nitrogen was saved in drip irrigation.

Wilson and Bauer (2005) reported that drip irrigation is the best method of irrigation in areas having water shortage. It can be automated with the help of a controller.

Bozkurt and Mansuroglu (2009) studied the performance of different types of drip irrigation and found that maximum yield was obtained from plant to which subsurface drip irrigation given.

Singh (2009) conducted study of drip irrigation in potato and reported that it gives higher water use efficiency compared to surface irrigation. It also gives higher yield and has less weed growth.

Riberio *et al.* (2015) conducted study on onion yield at different levels of water application through drip irrigation. The conducted trials with different percentages of irrigation water depth and reported that maximum yield obtained at 100% irrigation.

Lee *et al.* (2017) conducted study on concentration of microcystin in carrots, lettuce and green beans irrigated through drip irrigation and spray irrigation. They reported that method showed presence of microcystin in vegetables.

2.4 FERTIGATION

Application of fertilizer along with water is called fertigation. Through fertigation, precise application of water and nutrients can be at the root zone of crop. It saves labour and money for the application of fertilizer and water.

Drip irrigation and fertigation saves water and fertilizers and ensures uniform distribution of fertilizers. It causes minimum damage to crop and soil. Precise application of water and fertilizer through drip irrigation and fertigation leads to higher yield from crop. The advantages of fertigation are reduction in labour cost, split doses of fertilizer can be applied, quick application of nutrients, saving of fertilizers, saving of time and energy, minimum leaching of fertilizers and minimum loss of nutrients (Haynes,1985, Mikklessh,1989, Kumar,1992).

Bachav (1995) conducted a comparative study on fertigation and conventional method of fertilizer application. The yield and performance of crops

were compared. The test resulted that maximum yield was obtained from fertigated crops.

Design of irrigation system should be in such a way that it should be capable of precise application of water and nutrients to the plant root zone. The system should provide maximum efficiency and uniform distribution of water and nutrients (Gowda, 1996).

Hagin and Lowengart (1996) reported that in case of crops which are irrigated through drip system nutrients along with irrigation water is best applied to provide nutrients at the root zone, which gives maximum yield. Leaching of fertilizer can be avoided by providing required concentration of fertilizer solution.

Prabhakar and Hebber (1996) conducted a study on performance of tomato crop under fertigation and conventional method of fertilizer application. The study found that yield of crop which was undergone fertigation was 22-27 percent higher than that of conventional method of fertilizer application on soil.

Mortvedt(1997) reported that fertigation is best method of nutrient application in greenhouses because it provides balanced nutrient supply to the plants. The growth and yield of plants will be better for fertigated crops grown in well managed growing media.

Clogging is the major problem in fertigation. Water having high value of pH and also having higher concentrations of calcium and magnesium bicarbonates reacts with the phosphorous and there may be chance of forming precipitates. This may leads to clogging of drippers and filters and the fertigation system performance may be affected. This can be avoided by using MAP (mono ammonium phosphate) and phosphoric acid. To avoid clogging, periodic injection of acids like hydrochloric acid, sulfuric acid, nitric acid or phosphoric acid is to be done. Most commonly used one is hydrochloric acid. Acid injection through fertigation system removes algae and bacteria in addition to the removal of precipitates (Imas, 1999).

Fertigation is the technique of application of nutrients through irrigation water, which has several advantages. In fertigation, water and nutrients is applied at root zone of crop and hence fertilizer use efficiency is very high. Fertigation increases availability of fertilizer to plants. Through fertigation, there is a saving of 20-40 percent fertilizers. This saves the time and labour for fertilizer application (Khan *et al.*, 1999).

Srinivas (1999) reported that fertigation gives 20-25 % saving of fertilizers, if proper dosage of fertilizer can be provided at different stages of crop growth.

Loccasio(2000) reported that loss of nutrients from root zone was less in the case of fertigation. The nutrient use efficiency is high in fertigation compared to manual method of fertilizer application.

Singh *et al.* (2001) studied the efficiency of fertigation in broccoli crop for sandy loam soil condition. The study found that there is saving of 20- 40 percent fertilizer if it is given through fertigation.

Manickasundaram (2005) reported that plants absorb more nutrients if it is provided through fertigation. In traditional method there are wastage of water and fertilizer compared to fertigation. Fertigation improves the yield of crops and reduces cost of production.

Kumari and Anitha (2006) conducted experiment on performance of chilly, french bean and amaranthus under fertigation. The results found that fertigation is better for these crops.

Kumar *et al.* (2007) conducted fertigation study on brinjal crop. Observations were taken on shoot length, number of branches per plant and yield. The results showed that best performance was from the treatment of 75% pan evaporation with 75% recommended dosage fertilizer applied through fertigation.

Yaser (2009) conducted fertigation study on tomato crop. The study proved that higher yield could be obtained in case of crops undergone fertigation. Moreover it provides higher water and fertilizer use efficiency.

Jat *et al.* (2011) presented a comprehensive review about fertigation application through drip system. They reported that fertigation has advantages such as high productivity, less weed growth, higher quality of product and also can be applied at undulating fields. Fertigation through drip system reduces leaching. The higher cost of installation is its disadvantage, but for long term application, it is beneficial.

Antille (2017) conducted study of effectiveness of fertigation and normal method of fertigation. Test results found that better yield and uniformity of crops were obtained from fertigated field compared to traditional method of fertilizer application.

2.5 GREENHOUSE AUTOMATION

One of the main problems being faced by the greenhouse growers is the precise microclimate control and timely application of water and fertilizers. Manual method of application of fertilizer and irrigation and microclimate control is time consuming and a laborious process. Hence greenhouse automation is required for better greenhouse cultivation.

2.5.1 Automatic Microclimate Control in Greenhouses

The greenhouse microclimate is different from the ambient climate because of the presence of covering material. Covering material of greenhouse is acting as a barrier between greenhouse microclimate and ambient climate. The greenhouse cover causes changes in the microclimatic condition as compared to that of outside by reducing intensity of solar radiation and air velocity, by increasing temperature and relative humidity of the air and by making the fluctuations in carbon dioxide concentrations. Each of these changes has its own impact on growth, production and quality of the greenhouse crop, some of them

being detrimental and hence greenhouse microclimatic conditions are to be modified based on crops to be cultivated and ambient climate. By suitably modifying these microclimatic parameters, we can increase the yield of crop in greenhouse cultivation.

Greenhouse crop production is based on a controlled environment to provide the necessary conditions that are most favourable for maximum crop yield. Optimization of the greenhouse environment is achieved by controlling atmospheric as well as soil factors to the required level of the particular crop. Atmospheric parameters include air temperature, solar radiation, relative humidity, air composition and air velocity and soil parameters include soil temperature, soil moisture, soil pH, soil nutrient status and soil physical, chemical and biological parameters. Greenhouse environmental conditions are managed by manual or automatic control system which comprises measurement, data processing, recording and management of environmental parameters. Development of an automated greenhouse system that is low cost, operates with minimum human intervention, accurately able to maintain its set points, able to learn and adjust itself have been some of the very obvious interests in which investigators are working to fulfill economic, environmental, market, industrial and human preference needs (Salokhe and Sharma, 2012).

2.5.1.1 *Thermostats*

Thermostat is a device for sensing temperature and for activating/deactivating the attached equipment with reference to a set of temperature. Thermostat is made by either a bimetallic strip or thin metal tube filled with fluid as sensor and it will produce some physical displacement corresponding to the temperature. These sensors activate a mechanical switch by differential expansion of bimetallic strip or by movement of tube due to change in the volume of fluid. The main disadvantage is its less accuracy (Manohar and Igathinathen, 2012).

2.5.1.2 Microprocessor

Microprocessors considered as simple computers can be used for more accurate management of greenhouse microclimate than thermostats. It has a keypad, LCD screen, indicators and provision for input and output connections. They can control many devices at a time based on input parameters. They receive signals from sensors for temperature, relative humidity, light intensity, wind speed etc. and operate different microclimate control devices such as ventilators, fans, evaporative cooling system, etc. They usedifferent types of temperature sensors thermistor, thermocouples or IC (Integrated circuits) chips. Thermistor is a solid state integrated circuit chip that changes the output voltage according to temperature change. A thermocouple consists of two dissimilar metallic wires joined together to form two junctions. One junction connects to the place where temperature is to be measured and the other end is to be connected to the surface having reference temperature. Thus the thermocouple measures unknown temperature, based on known temperature of reference body. An electronic circuit connects sensors to microprocessor and to different instruments such as fans, evaporative cooling system etc. through a relay. Greenhouse automation system mainly uses microprocessors as controllers.

Bontsema *et al.* (2005) conducted a study on automatic estimation of the greenhouse ventilation rate and control of ventilators. They designed and developed the system and was tested successfully.

Wang *et al.* (2009) developed a multi-channel system for simultaneous monitoring of multiple environmental factors and electrical signals in cucumber plants in the greenhouse. The system includes a special sensor, which is both sensitive and reliable for long-term use for collecting electrical signals. Using this system, they proved that the electrical signals in plants respond to environmental changes under natural conditions in the greenhouse. The system could provide a long-term stable tool to measure and analyze the electrical signals in plants in greenhouses.

Ahonen *et al.* (2010) developed a greenhouse monitoring and controlling system using WSN. The system used temperature sensor, RH sensor and light intensity sensor. The data regarding greenhouse parameters were collected and stored. Whenever the parameters exceeds the preset threshold level the actuators operated by the controller. The developed system tested in a greenhouse with tomato plant inside it.

Chaudhary *et al.* (2011) developed a greenhouse parameter control system using wireless sensor network (WSN). They tested the developed system in a greenhouse and found to be good in greenhouse microclimate control. They used WSN for the data collection and control of greenhouse parameters.

Hahn (2011) developed a controller for sunlight control in greenhouse to avoid cracking of tomato inside the greenhouse. The controller used fuzzy logic and was capable of minimizing the cracking of tomato. The controller operates a motor and thus shading was done automatically based on the intensity of solar radiation. The system was capable of maintaining greenhouse temperature below 30⁰C.

Linker *et al.* (2011) developed a greenhouse automation system. The main part of the system was the controller and it was designed by using robust control method quantitative feedback theory. The actuators used were foggers and fans. Based on the set parameters the variable pressure foggers and variable speed fans were operated by controller.

Bhujbalet *et al.* (2012) developed a microcontroller based automation system for greenhouses which monitors and controls greenhouse parameters such as temperature, relative humidity, soil temperature and light intensity. The different sensors installed collects information and microcontroller manages greenhouse parameters. The collected data was stored in SD cards in CSV (Comma separated variable) format. The system was found to be good for controlling greenhouse parameters.

Boojet *al.* (2012) developed an automated climate control device for layer wise microclimate management in greenhouses. This system was developed for the multilayer cropping inside the greenhouse. Fans were provided at each layer and measurements of parameters were done at each layer. Based on the preset values the microclimate was managed in each layer separately.

Dondapati and Rajulu (2012) designed a sensor based automation system for greenhouse capable of managing the greenhouse without any human interference. Based on real time data collection from different sensors, it is capable of controlling the greenhouse microclimate by operating foggers, fans, irrigation system and lighting system. Real time display of microclimatic data on liquid crystal display screen helps the greenhouse technicians to know the exact environmental parameters in it. The system consists of different sensors for collecting data, analogue to digital converter, microcontroller and actuators. Threshold values of microclimatic parameters can be set according to the crops to be cultivated and when any of the parameters exceeds the threshold value, the microcontroller actuates the required equipment to maintain favourable environment for crop growth. Experimental results showed that the system performance is good for managing greenhouses.

Kohle and Annadate (2012) developed an automation system for greenhouse using ARM7 controller. Main parts of system were LPC2148 microcontroller. The different sensors used were LM35 temperature sensor, SY-HS-220 RH sensor and LDR (light dependent resistor) light sensor. The system used ARM based system board. The developed system was capable of managing greenhouse environment.

Vidyasagar (2012) developed a system to automatically monitor and manage greenhouse climate using wireless sensor network (WSN) and GSM (global system for mobile communication). WSN was used for collecting and sharing sensed data. The automation system has sensors for collecting information about temperature and soil moisture. Two actuators were used –

exhaust fans and micro sprinklers for water application. Microcontroller used was PIC16F877A. The automation system that operates the fan and micro sprinkler depends on the preset threshold level. The information regarding this will be sent to the registered mobile number.

Waykoleand Agrawal (2012) proposed a greenhouse automation system based on microcontroller. The system collects data regarding greenhouse microclimate using WSN and transmits through Zigbee. The collected data will be sent to the microcontroller and based on the preset threshold level it operates the actuators to manage the greenhouse.

Cepeda *et al.* (2013) developed and tested an automation system for greenhouses. They incorporated artificial intelligence to manage the greenhouse microclimate. The system was successful in precise management of greenhouse climate.

Gayatri (2013) proposed a greenhouse automation system which uses Psoc 3 kit. The proposed system consists of actuators, relays, Psoc 3, temperature sensor and RH sensor. The temperature sensor used was Lm35DZ and the RH sensor was SY-HS-20. The sensors used were transducers. Transducer converts physical quantity into electrical quantity. The system uses Psoc3 which is a programmable system on chip. Based on the programme and the preset threshold levels of parameters, automation system manages the greenhouse climate.

Salleh *et al.* (2013) developed a greenhouse automation system using wireless sensor network (WSN) and Zigbee technology. The developed automation system was tested in a greenhouse. The parts of the automation system include 9V DC power supply, WSN, Zigbee transmitter, microcontroller and actuators. The collected data were shown on an LCD screen. For the programming and interfacing process, C compiler and MPLAB software were used. Based on the preset conditions, the microcontroller manages greenhouse microclimate by operating the actuators.

Dinesh and Saravanan (2014) designed and developed an automated greenhouse monitoring system. They used programmable logic devices (PLD) because it allows the design of automation system using field gate arrays (FPGA). The developed automation system includes sensors for temperature and relative humidity, analogue to digital converter (ADC) and FPGA. The measured greenhouse parameters can be viewed on the LCD screen. This system satisfactorily worked during testing. Whenever the greenhouse parameters exceeded the threshold level, the designed controller operates the actuators to manage the greenhouse climate.

Eldhose *et al.* (2014) developed an automated greenhouse monitoring system using microcontroller PIC 16F877A. This microcontroller controls the greenhouse environment based on the preset conditions and the measured climatic parameters. The automation system thus saves labour cost required for greenhouse environment control. It automatically collects the data regarding climatic and soil parameters and operates the actuators. It has the capacity to analyze the data regarding temperature, relative humidity, soil temperature and light intensity and to manage the greenhouse for better crop production.

Parvez *et al.* (2014) developed and tested a greenhouse automation system for greenhouse climate control. The system controlled the greenhouse microclimate satisfactorily. The automation system has mainly three stations such as sensor station, co-ordinating station and central station. Wireless sensors were used for this automation system. Zigbee wireless modules were used for the communication between sensor station and coordinating station and also between central station and coordinating station.

Poyenet *al.* (2014) developed an automation system to operate the shade cover on greenhouse. Based on the light intensity, the automation system operates a motor which cover or fold the shade cover. The automation system used Arduino microcontroller, a logic circuit, light sensor and motor driven shade cover. Based on the pre set values the automation system operates.

Thenmozhi *et al.* (2014) developed a greenhouse automation system to manage the greenhouse remotely and automatically. It used embedded system and Zigbee technology for the effective management of the greenhouse climate. By using Zigbee technology an alert message was sent to the user. The user can operate the actuators remotely through the server and microcontroller. The microcontroller used in the automation system was PIC 16F877A. In the full automatic mode, the microcontroller itself managed the greenhouse based on the preset threshold level. The message regarding this was sent to the user and the data was stored in the server.

Bajar and Krejcar (2015) developed a low cost greenhouse automation system operated by remote control. Arduino MEGA 2560 is the controller of this automation system. The system includes sensor, controller and actuators. The parameters can be viewed through an LCD screen. The developed system was tested and found that it worked satisfactorily.

Bhanu and abhinesh (2015) developed a greenhouse automation system based on Zigbee and GSM technology. There were two modes for the automation system such as monitoring mode and sink mode and which are connected using Zigbee. The data were collected through temperature sensors (LM35), relative humidity sensors (DHT11), light intensity sensor (LDR) and soil moisture sensor. The microcontroller used for designing the automation system was ATMEGA 16. Whenever any of the greenhouse parameter exceeds the pre set threshold level, remedial action will be taken by the microcontroller automatically and a SMS will be sent to the registered mobile number through GSM module.

Joteppagol and Kore (2015) developed a greenhouse automation system which used CAN (controller area network) for communication. The temperature sensor used in the system was LM-35 and the relative humidity sensor used was SY-HS-220. The microcontroller was PIC 18F 458 and the actuators used were exhaust fans for cooling and LED (light emitting diode) artificial light. Based on the preset conditions the actuators were operated by the microcontroller.

Nishina (2015) established an IGS (Intelligent greenhouse system) for greenhouse management. Speaking plant approach is the basis of IGS. Based on the physiological status of plants, optimal conditions of crop growth varies, which is the basis of SPA. A robot was developed for the monitoring of tomato plants by measuring induction curves. The developed robot images chlorophyll fluorescence for the study of tomato plants.

Canadas *et al.* (2017) developed a greenhouse climate control system capable of minimizing the disease incidence by maintaining required climate inside the greenhouse. They incorporated real time greenhouse monitoring and management system. The decision support system was capable of giving instructions to modify the microclimate in case of any disease detected. In this way the system was capable of minimizing disease due to the problem of incorrect climate inside the greenhouse.

2.5.1.3 Computer Controlled Systems

This is the higher end method of microclimate control in greenhouses and mostly used in developed countries. Computer controlled systems can integrate the parameters from different sensors and precise control of the microclimate is possible through this system. Based on the programme used, the computer will activate or deactivate the different control devices, ventilators, shading devices, fans etc. based on input parameters such as inside and outside temperature, humidity, outside wind condition, inside carbon dioxide concentration, etc. Computer receives signals from all sensors, evaluates all conditions and it will operate different equipment based on the crop inside the greenhouse. Computer also record the data received which will be very useful information in precision farming because this data will provide comprehensive knowledge of all factors affecting the quality and quantity of product.

Advantages of computerized control include

- As computers control precisely, there will be saving of inputs and energy and chance of pest and disease attack will be less in computer controlled systems.
- With the help of a good programme, computer will co-ordinate all the equipment for microclimate control.
- The computer can record and store environmental data which will provide a history of cropping period.
- A single computer can manage many greenhouses if programmed and managed.

Disadvantages include

- High initial investment required.
- Requires qualified technicians for operation and maintenance
- High maintenance cost
- Not economical for small and medium scale farmers.

Stratenet *et al.* (2002) presented a review about the computer algorithms used for greenhouse climate based on literature and survey they conducted. They compared different control strategies used for computerized greenhouse climatic control.

Helmer *et al.* (2005) developed Crop Assist, an automation system for direct measurement of greenhouse tomato growth and water use. The system used pairs of load cells and a trough system to capture crop growth and water use, and many irrigation parameters may be measured simultaneously. The system concurrently monitors four sites, with up to 12 plants each, but is expandable as needed with more sites strategically placed in the greenhouse.

Korner *et al.*(2007) developed greenhouse crop photosynthesis measuring system based on net CO₂ exchange of crop and tested with cut chrysanthemum crop. The system works at various CO₂ concentration levels, different temperature levels and at various light intensities. The testing of the computer controlled system was done in two air tight greenhouses. Results found that this can be used as photosynthesis measuring system.

Ota *et al.* (2007) developed and tested a leaf picking device for cucumber cultivated inside the greenhouse. They tested the device in laboratory condition and in actual greenhouse. Testing was done at different speed and torque. Test results proved that this device can be used in robotic systems to automatically pick the leaves of cucumber plants.

Bennis *et al.* (2008) developed a model for climate modeling and control of greenhouses. This model controls greenhouse climate based on temperature and relative humidity. The system was tested in a greenhouse and got successful results.

Ehret *et al.*(2011) developed a neural network model that can be used to find out the greenhouse tomato growth and yield and water use from the automatic monitoring of greenhouse crop attributes. The automated measuring device takes continuous minute by minute measurement of crop yield, growth and water use and also gives average values on hourly, daily, weekly or monthly basis. The data collected from automated crop monitoring station is used in the neural network model to predict crop attributes. They related the environment data crop yield and also the weekly growth and yield of next week.

Junxiang and Haiqing (2011) designed a greenhouse surveillance system based on embedded web server technology. Based on ARM-Linux development environment, they constructed embedded web server and used it in acquisition and transmission of greenhouse information. Experiment results show that the working performance of the system is quite stable and can reach the design requirements in real-time data acquisition and remote control.

Khandelwal (2012) developed a GSM modem based automation system to control greenhouse microclimate. The system consists of various sensors to collect information about greenhouse temperature, relative humidity, light intensity, rain sensors and transistor switches and relay nodes for automation control. There is a data server to store the information about the environmental conditions inside the greenhouse. Based on the requirement of crop, automation system will maintain required environmental conditions for crop growth.

Dhumal and Chitode (2013) proposed a server based greenhouse automation system which uses Zigbee technology and smart phone. The wireless sensor network collects real time data and transmits to the server through Zigbee. For synchronizing the server and smart phone TEAM VIEWR synchronizing software was used. Software was developed in visual basic to communicate and control the greenhouse parameters. The information regarding the greenhouse parameters was sent to the user by SMS. The server and android phone of the user are connected through internet. The user can operate the automation system by the android phone through the interface.

Belsare *et al.* (2014) developed a greenhouse automation system which can be operated through an android phone or can be operated automatically. The data collected from sensors goes to a server and based on the preset threshold values, it send signals to operate the actuators if it is in automatic mode. If it is in manual mode, message was send to user and can be operated by the user through the android phone.

Matrinovic and Simon (2014) developed a mobile measuring station for greenhouse microclimate control. They used wireless sensor networks (WSN) for gathering and monitoring microclimate parameters both inside and outside the greenhouse. They fitted the sensors on a robot and navigation of robot was done through WSN. From the starting point, the mobile robot should find a path to the target in a dynamic environment, avoiding any obstacles. They also developed an expert system to control the various environment control equipment attached to

the greenhouse based on the collected data. The expert system is a multi- criteria decision making based on application of fuzzy rules. They developed six control strategies for managing greenhouse microclimate based on sensed values of different parameters. Six control strategies were developed: STR1 – Day High Performance, STR2 – Day Normal, STR3 – Day Economic, STR4 –Night High Performance, STR5 – Night Normal, and STR6 –Night Economic. The best control strategy was selected based on input parameters.

Attia and El – madany (2016) developed and compared four different types of greenhouse temperature control strategies simulated using MATLAB/SIMULINK. Greenhouse temperature controller techniques used were adaptative neuro fuzzy control, fuzzy logic control, PI control and artificial neural network control. After testing it was found that adaptative neuro fuzzy control was the best among them to control greenhouse temperature.

2.5.2 Automatic Irrigation and Fertigation in Greenhouses

Manipulation of the crop growing medium is another important factor to be done for getting maximum yield from plants. This is mainly done by application of required fertilizers and irrigation and manual application of it a laborious process. Automated irrigation and fertigation in greenhouses gives maximum yield because it can be given in split doses so that there won't be any nutrient loss. Based on the real time need of water and nutrients it can be given in automatic irrigation fertigation.

Morari and Giardini (2002) reported about irrigation automation for heterogeneous vegetation. The experiment was conducted at Padova botanical garden. The automation system integrated data on soil and water status collected by sensors. The different parts of automation system include a)irrigation system and micro computer b) soil moisture sensors c) irrigation management software and d) data logger to collect and store data. Based on the sensed data and pre set conditions, irrigation water applied to the respective crops.

Savvas (2002) developed two alternate models for automatic application of nutrients in hydroponics. These models were tested and the results were compared. Both the models were found to be able to supply nutrients at desired levels.

Brajeuland Maillard (2006) reported about a prototype for application of water and nutrients depending upon the need of the crop. It was developed by the EU project CLOSYS (Closed system for water and nutrient management). The developed system includes plant and substrate sensors and plant model. Based on the plant model and information from the sensors automatic application of water and nutrients can be done.

Farina *et al.* (2006) compared two types of fertigation automation systems. One of the automation systems was made by using a timer for the application of irrigation and fertigation. The other one was made by using a controller and frequency domain sensor probe. The performances of the systems were evaluated with rose crop. After testing, it was found that controller and sensor based automation system was better than the timer based automation system.

Kia *et al.* (2009) developed a fuzzy logic based automation system for irrigation in greenhouses. The fuzzy logic controller was built using MATLAB software. The developed system was capable of accessing the parameters and managing the irrigation in greenhouse.

Ahmad *et al.* (2011) developed a speaking plant approach to fertigation automation by providing charge coupled device cameras to take images of plant and it is sent to image processing unit. Based on the images, the requirement of plant is accessed and based on that fertigation system can operate.

Gautam (2012) developed an irrigation automation system. The system was GSM Bluetooth based remote controlled embedded system. The sensors collect information which is sent to the registered mobile number through GSM

network. If the operator is within 10m distance, then instead of SMS, bluetooth will be used.

Salihet *al.* (2012) developed a solar powered fertigation automation system. The only input parameter of the fertigation automation system was EC and it was measured by using sensor. Based on the real time monitoring of EC and based on the crop need set by the user, fertigation was done at different stages of crop, automatically. The automation system was capable of doing all the fertigation operations such as mixing of fertilizer and injection of fertilizer solution at the required time and dose. Solar panels, solar charge controller and storage battery were used to produce and use solar power for fertigation automation. The battery can hold up to 72 watt hours/day and the solar panel used can produce 140 watt hours/day. The power requirement of the automation system was 10watt hours/day. Hence even if there is no sunshine for 7 days, the automation system can work from power stored in the battery.

Kaur and Kumar (2013) developed a micro controller based fertigation automation system. The system includes sensors for measurement of EC and pH of fertilizer solution and soil and a micro controller for the control of the system. Based on the sensed value of EC and pH of soil microcontroller will be activated to get required amount of fertilizers in the mixing tank and thus required amount of fertilizer can be applied to plants.

Iacomiet *al.* (2014) developed a computer controlled system for precise application of water, fertilizer and pesticides. The system consists of a data acquisition unit, a central processing unit and a driving unit. The data is collected from soil and plant through sensors provided and is sent to central processing unit. The embedded software processes the data and based on that required quantity of water and chemicals will be applied. The system thus reduces the use of inputs required for plants and leads to profit. Moreover it was an environment friendly approach.

Netoet *al.* (2014) developed a fertigation automation system for the soilless cultivation of tomato. Tomato was grown inside the greenhouse by using sand substrate under soilless cultivation. The automation system supplied the water and nutrients based on the transpiration rate estimated and by measurement of EC of medium. The system was found to be good in application of nutrients and minimizing environmental pollution by reducing the effluent disposal.

Raine and Mc Carthy (2014) reported about VARIwise – software for the automatic application of water and fertilizer. The software developed by NCEA (National centre for Engineering in Agriculture). The field data was collected by soil sensors and real time cameras. Based on the collected data and the calibrated crop model, water and nutrient can be applied.

Pawlowski et al. (2017) conducted a study on evaluation of event based irrigation system control scheme for tomato crops grown in greenhouses and evaluated event based predictive irrigation control system. The control system used a crop transpiration model to determine the volume of water required to compensate for the irrigation system and a water content model to trigger the irrigation events. Test results proved that 20% water savings obtained.

Sunny and Hakkim (2017) developed a solar powered fertigation automation system for greenhouse cultivation. They conducted performance evaluation of the developed system in one greenhouse at Agricultural Research Station Anakkayam, Kerala. For comparison purpose, same crop (salad cucumber) was cultivated in another greenhouse without automation close to the automated one. Test results proved that there is significant difference between yield and growth of plants inside greenhouse with automated fertigation system and with manual application of fertilizer. Automated fertigation system gave more yield and better plant growth than manual fertigation.

CHAPTER III

MATERIALS AND METHODS

The materials used and methodology adopted for the refinement of the existing low cost greenhouse automation system and its evaluation are explained in this chapter. The existing automation system developed at the ARS Anakkayam does not have the provision to logically operate exhaust fans and foggers. This is required to reduce temperature inside the greenhouse without increase of relative humidity beyond the desirable upper limit of crop inside the greenhouse. This limitation of the automation system was rectified and evaluation of the refined automation system was done with salad cucumber crop (*Cucumis sativus*) grown inside a naturally ventilated greenhouse. The experiment was conducted during three crop seasons with the same crop inside the automated greenhouse (AGH) and for comparison, the same variety of salad cucumber was grown inside another greenhouse without automation system. One set of crop was grown outside the greenhouse and observations from that crop also were taken and compared.

3.1 LOCATION OF THE EXPERIMENT

The experimental site was located at Agricultural Research Station Anakkayam which is situated at 11⁰5'2"N latitude and 76⁰7'13"E Longitude.

3.2 TIME PERIOD OF THE EXPERIMENT

The refinement of the existing automation system at ARS Anakkayam was done from July 2015 to October 2015. Performance evaluation of the refined automation system was carried out from December 2015 to February 2017, first by checking the performance the system without crop inside the greenhouse, thereafter with cucumber crop grown inside the greenhouse. Performance of the automation system without crop was evaluated from 1-12-2015 to 7-12-2015. Evaluation with crop inside the greenhouse was done thrice, from 14-12-2015 to 13-3-2016 for the first season, 2-5-16 to 31-7-16 for the second season and 22-11-16 to 20-2-2017 for the third experimental season. The study was carried out

during all the three crop seasons with the same crop inside the automated greenhouse (AGH), inside the non automated greenhouse (NAGH) and outside the greenhouse (OGH) and observations were taken.

3.3 WEATHER AND CLIMATE

The study area falls under humid sub-tropical climate. South West monsoon contributes the major share of rainfall. The area receives some amount rain fall during North East monsoon and as summer rains. Since it is a hilly area with undulating topography, during summer, temperature is very high and with dry climate and during winter temperature is not much high. The soil type of the experimental site is laterite. The major microclimate parameters which affect crop growth such as temperature, relative humidity and intensity of solar radiation were measured inside the automated greenhouse, non automated greenhouse and outside the greenhouse during the study period.

3.4 EXISTING AUTOMATION SYSTEM

A locally developed low cost automation system was already in use at ARS, Anakkayam. The system consists of a microcontroller, relays and exhaust fans and foggers as actuators. Based on the temperature inside the greenhouse, it controls the operation exhaust fans and foggers. The limitations of this automation system are excess relative humidity build up due to continuous operation of foggers and it cannot automate irrigation and fertigation operations.

3.5 REFINEMENT OF THE EXISTING AUTOMATION SYSTEM

Greenhouse cultivation is being done to get maximum yield from unit area. Because of the presence of the cladding material, the microclimate inside the greenhouse is different from that of outside. During peak hours of day in the summer season, temperature inside the greenhouse will be very high and it is to be reduced in the humid tropical condition. To reduce temperature inside the greenhouse different cooling mechanisms can be used. In the experimental greenhouse exhaust fans and foggers were used to reduce the temperature inside

the greenhouse. These foggers and exhaust fans were operated by a low cost automation system. The refinement of this existing automation system was done after studying the disadvantages of the existing system. The original system does not have the provision to intelligently control temperature and relative humidity. The automation system operates foggers and fans at the same time if the temperature is less than the pre-set threshold level. Due to this reason, while temperature inside the greenhouse decreases, relative humidity inside the greenhouse gets increased to a higher level and the crop inside gets affected. This does not have provision to operate fans or foggers along with fans depending upon the microclimatic condition. This is due to the problem of the microcontroller used in the automation system. Microcontroller used at that time has only one set point and hence either threshold level of temperature or relative humidity can be set. Thus, if temperature is the parameter used for microclimate control it cannot control relative humidity within the desirable limits of the crops and vice versa. Moreover, the automation system does not have provision for automatic irrigation and fertigation. To overcome all these shortcomings, new microcontroller was used for the automation system and a timer was also incorporated for automation of irrigation and fertigation.

Greenhouse microclimate management is to be done based on the requirement of the crop inside the greenhouse. If the temperature is more than that of the desirable maximum value, it is to be lowered. At the same time the relative humidity should not be more than the maximum threshold value of the crop inside the greenhouse. Manual control by checking the temperature and RH inside the greenhouse is time consuming and practically impossible to manage. Greenhouses using manual controls operates the actuators like fan and pad or foggers for a particular period of time and put off for another particular period of time. This process, if done manually, is very tedious and labour consuming. Moreover, while operating the foggers, the RH inside the greenhouse will be increased to higher values which is not desirable for crop. During the rest period of actuators, the temperature inside the greenhouse will become very high and that also is not good

for the better performance of the crop. Manual irrigation and fertigation inside the greenhouse is also a time consuming and laborious process. It is very difficult for the farmer to manually irrigate crops inside the greenhouse three or four times daily. Moreover, in greenhouses, fertigation is a better means than manual fertilizer application. Automatic irrigation and fertigation saves time and labour cost of the farmer. Keeping the above aspects in mind, the refinement of the system was done so that the crop will not get damaged and the cost of the system will be cheap.

3.6 REFINED AUTOMATION SYSTEM

The refined microcontroller has capacity to logically manage temperature inside the greenhouse without any abnormal shoot up of relative humidity inside the greenhouse. It uses a two set point microcontroller for automatic management of microclimate inside the greenhouse. One of the set points was used for controlling the temperature inside the greenhouse and the other one for controlling the RH inside the greenhouse. Depending upon the crop inside the greenhouse the set points can be changed. Based on pre defined set values, the automation system manages the temperature and RH inside the greenhouse during peak hours of the day and hence unnecessary labour for operating the fans, irrigation valves and foggers can be avoided. The modified automation system was made using logical circuit of different components. The automation system manages temperature inside the greenhouse, at the same time; RH will not go beyond the desirable limit. Automatic irrigation and fertigation also can be done using this system. Automation system includes different components such as temperature sensor, RH sensor, microcontroller, relays, timer, fertilizer injectors, exhaust fans, foggers, solenoid valves, transformers, rectifier etc. The closed view of the automation system is shown in Plate 1, opened view in Plate 2 and side view in Plate 3. The experimental greenhouse is shown in Plate 4. The circuit diagram of the automation system is shown in Fig. 3.1.

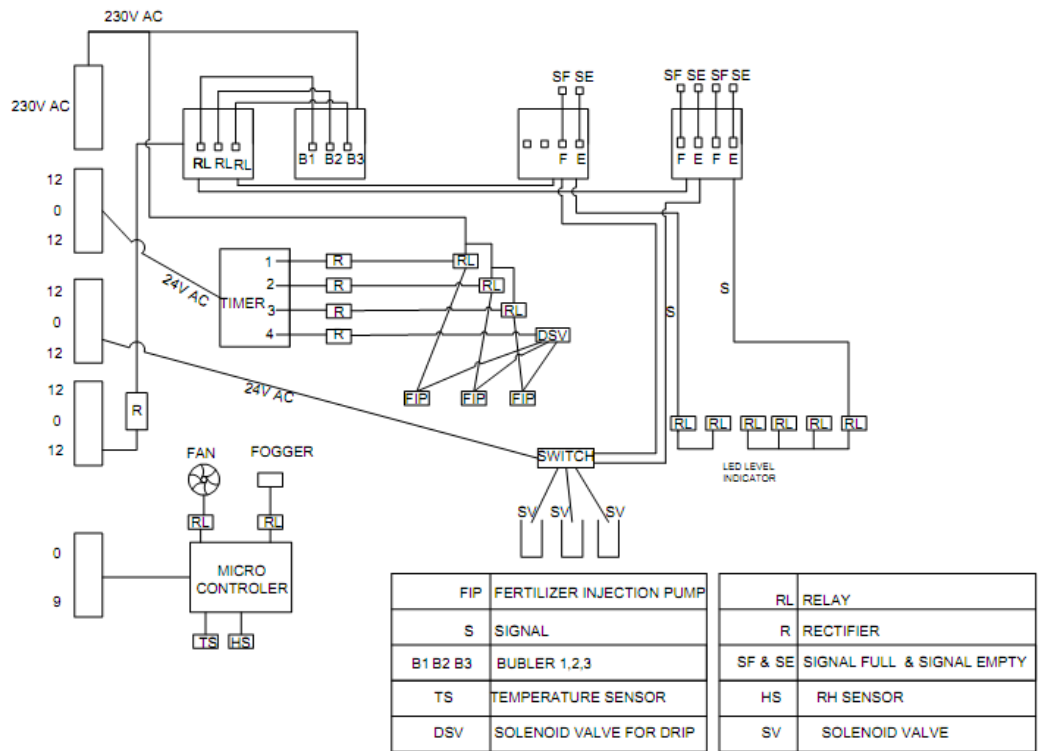

Fig. 3.1 Logical circuits in the system

3.6.1 Microcontroller

Microcontrollers are considered as simple computers that can be used for management of greenhouse microclimate. It has a keypad, LCD screen, indicators and provision for input and output connections. Depending upon the capacity of microcontroller it can control many devices at a time based on input parameters. They receive signals from different sensors attached to it such as temperature, relative humidity, light intensity, wind speed etc. and based on the pre-set threshold values it will operate different actuators such as ventilators, fans, evaporative cooling system, etc. Microcontroller used for the automatic climate control system was Sub-Zero 9922 which was a two set point controller that can control two parameters. One set point is for temperature control and the other one is for humidity control. Depending upon the crop cultivated inside the greenhouse the temperature and relative humidity limits can be set on the controller.

3.6.1.1 Specifications of Micro Controller

The specifications of microcontroller are given in Table 3.1

Table 3.1 Specifications of micro controller

Dimensions	Front :75 X 34.5 mm Depth:71mm
Power input	230VAC \pm 10%, 50-60Hz.
Temperature range	0 ⁰ C to 99.99 ⁰ C
Humidity range	0% to 99%
Resolution	0.1 ⁰ C for temperature and 1% humidity
Accuracy	\pm 0.1 ⁰ C for temperature and \pm 3% humidity
Data storage	Non volatile LEEPROM memory
Output	R1,R2 8(3)A/250V AC
Input	Humidity Sensor(SZ-HS 100) Temperature Sensor(RTD)



Plate 1. Automation system enclosed in wooden casing (Closed position)

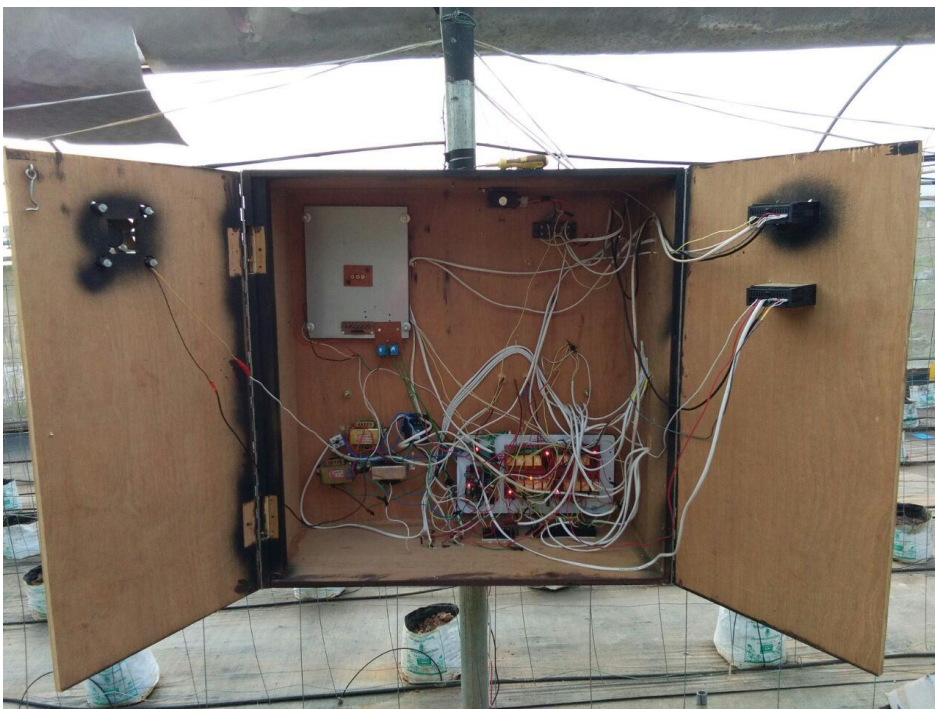

Plate2. Wooden casing containing logical circuits



Plate 3. Side view of the wooden casing containing logical circuits



Plate 4. View of experimental greenhouse

3.6.1.2 Emergency Messages Displayed on the Microcontroller

If the temperature or the relative humidity inside the greenhouse is above the set point, warning messages will appear on the display. The warning messages and its meanings are given in Table 3.2.

Table 3.2Emergency messages displayed on the microcontroller

Message	Meaning
HT	Temperature above the maximum value of set point
LT	Temperature below the minimum value of the set point
PP	Probe short circuit
HH	RH above the maximum value of the set point
LH	RH below the minimum value of the set point

3.6.1.3 Setting up of the Micro Controller

The steps for setting up of the microcontroller used is given below

- 1) Press and hold the 'SET' key for two seconds.

On the display board it can see that 't₁' and flash. 't₁' parameter is for setting the required temperature inside the greenhouse.

- 2) Again press 'SET' key for changing the required temperature.
- 3) Use '^' or 'v' keys for changing the previously fixed temperature
- 4) After changing to required temperature press 'SET' key.

If '-----' displayed then it is confirmed that the set value was stored in the memory.

- 5) Again press 'SET' key.

Then on the display it can be seen than 't₂' and flash. 't₂' parameter is for relative humidity.

- 6) Again press the 'SET' key.

- 7) Use ‘^’ or ‘v’ keys for changing the previously set value of RH to the required value.
- 8) After that press ‘SET’ key.
If ‘-----’ displayed then it is confirmed that the set value was stored in the memory.
- 9) For changing the other set values press and hold the ‘SET’ key for two seconds.
On the display board ‘p₁’ will be displayed and flash. ‘p₁’ is for fixing either for heating mode or cooling mode. ‘0’ is for cooling mode and ‘1’ for heating mode.
- 10) Use ‘^’ or ‘v’ keys for changing to cooling mode.
- 11) Again press the ‘SET’ key.
If ‘-----’ displayed, then it is confirmed that the set value was stored in the memory.
- 12) Press ‘SET’ key.
Then ‘p₂’ will be displayed which for fixing the maximum allowable high temperature inside the greenhouse.
- 13) Again press ‘SET’ key.
- 14) Use ‘^’ or ‘v’ keys for changing the previously set value of maximum to the required value.
- 15) Press the ‘SET’ key.
If ‘-----’ displayed, then it is confirmed that the set value was stored in the memory.
- 16) Press SET key again then ‘p₃’ will be displayed. ‘p₃’ is for setting the minimum allowable temperature inside the greenhouse.
- 17) Again press ‘SET’ key.
- 18) Use ‘^’ or ‘v’ keys for changing the previously set value of minimum temperature to the required value.
- 19) Press the ‘SET’ key.

If '-----' displayed, then it is confirmed that the set value was stored in the memory.

20) Press the 'SET' key then 'p₄' will be displayed. 'p₄' is for setting the differential temperature inside the greenhouse. This can be set from 1⁰C to 10⁰C. If this 'p₄' is set as 1⁰C and the maximum allowable temperature set was 36⁰C, then first operation the actuators will start at 36⁰C. But later actuators will start at 37⁰C. For the present work it was set as 1⁰C.

21) Again press 'SET' key.

22) Use '^' or 'v' keys for changing the previously set value of differential temperature to the required value.

23) Press the 'SET' key.

If '-----' displayed, then it is confirmed that the set value was stored in the memory.

24) Press the 'SET' key then 'p₅' will be displayed. 'p₅' is for setting the calibration of temperature sensor. The value of the temperature displayed is to be checked with a mercury thermometer. If there is any difference it can be changed accordingly. For example, if the mercury thermometer reading was 29⁰C and temperature reading on the display is 30⁰C, then take -1⁰C as calibration value. There is provision to set calibration from -9⁰C to 10⁰C.

25) Again press 'SET' key.

26) Use '^' or 'v' keys for changing the previously set value for temperature calibration to the required value.

27) Press the 'SET' key.

If '-----' displayed, then it is confirmed that the set value was stored in the memory.

28) Press the 'SET' key again then 'p₆' will be displayed. 'p₆' is for setting the time delay between two consecutive relay restart. This is for protection of actuators from continuous operation. It can be set between 0 minute to 20

minute. If it is set as 5 minute, then even if the temperature is above the set point, the relay will restart only 5 minutes after stoppage.

29) Again press 'SET' key.

30) Use '^' or 'v' keys for changing the previously set value of time delay to the required value.

31) Press the 'SET' key.

If '-----' displayed, then it is confirmed that the set value was stored in the memory.

32) Next step is setting up the required humidity levels for the greenhouse. For that Press and hold the 'SET' key again. On the display board 'H₁' will be displayed and flash. 'H₁' is for fixing the controller either for dehumidification or for humidification mode. '0' is for dehumidification mode and '1' for humidification mode.

33) Use '^' or 'v' keys for changing to the required mode.

34) Again press the 'SET' key.

If '-----' displayed, then it is confirmed that the set value was stored in the memory.

35) Press 'SET' key.

Then 'H₂' will be displayed which for fixing the maximum allowable RH inside the greenhouse.

36) Again press 'SET' key.

37) Use '^' or 'v' keys for changing the previously set value of maximum to the required value.

38) Press the 'SET' key.

If '-----' displayed, then it is confirmed that the set value was stored in the memory.

39) Press SET key again then 'H₃' will be displayed. 'H₃' is for setting the minimum allowable RH inside the greenhouse.

40) Again press 'SET' key.

- 41) Use ‘^’ or ‘v’ keys for changing the previously set value of minimum RH to the required value.
- 42) Press the ‘SET’ key.
If ‘-----’ displayed, then it is confirmed that the set value was stored in the memory.
- 43) Press the ‘SET’ key then ‘H₄’ will be displayed. ‘H₄’ is for setting the differential RH inside the greenhouse. This can be set from 1% to 10%. If this ‘H₄’ is set as 5% and the maximum allowable RH set was 65%, then first operation the foggers will stop at 65%. But for next restart it will stop at 70%. For the present work it was set as 5%.
- 44) Again press ‘SET’ key.
- 45) Use ‘^’ or ‘v’ keys for changing the previously set value of RH differential to the required value.
- 46) Press the ‘SET’ key.
If ‘-----’ displayed, then it is confirmed that the set value was stored in the memory.
- 47) Press the ‘SET’ key then ‘H₅’ will be displayed. ‘H₅’ is for setting the calibration of RH sensor. The value of the RH displayed is to be checked with another known device such as hygrometer. If there is any difference it can be changed accordingly. For example if the hygrometer reading was 53% and RH reading on the display is 55%, then take -2% as calibration value. There is provision to set calibration from -10% to 10%.
- 48) Again press ‘SET’ key.
- 49) Use ‘^’ or ‘v’ keys for changing the previously set value for RH calibration to the required value.
- 50) Press the ‘SET’ key.
If ‘-----’ displayed, then it is confirmed that the set value was stored in the memory.
- 51) Press the ‘SET’ key again then ‘H₆’ will be displayed. ‘H₆’ is for setting the time delay between two consecutive relay restart. This is for protection

of actuators from continuous operation. It can be set between 0 minute to 20 minute. If it is set as 5 minute, then even if the temperature is above the set point, the RH relay will restart only 5 minutes after stoppage.

52) Again press 'SET' key.

53) Use '^' or 'v' keys for changing the previously set value of time delay to the required value.

54) Press the 'SET' key.

If '-----' displayed, then it is confirmed that the set value was stored in the memory.

55) Press 'SET' key. 'LP' is displayed and it is for locking or unlocking the key pad. '0' for unlocking the key pad and '1' for locking the key pad. If it is locked all the parameters can be viewed but cannot be modified. This is for avoiding tampering from others.

56) Again press 'SET' key.

57) Use '^' or 'v' keys for locking or unlocking.

58) Press the 'SET' key.

If '-----' displayed, then it is confirmed that the set value was stored in the memory.

59) Press 'SET' key. Then 'EO' will be displayed. This key is to toggle the display between temperature and RH. It can be set between 0 to 20 seconds. For example if the EO is set as 10 seconds then for the first 10 seconds it will display temperature and next 10 seconds RH and this will be repeated. If the EO is set as 0 seconds then manually °C/%RH key is to be used for knowing the temperature and RH inside the greenhouse.

60) Again press 'SET' key.

61) Use '^' or 'v' keys for changing the previously set value.

62) Press the 'SET' key.

If '-----' displayed, then it is confirmed that the set value was stored in the memory.

- 63) Press 'SET' key. 'FS' will be displayed. This is for restoring factory settings. There are two options, '0' and '1'. '0' for our settings and '1' for factory settings.
- 64) Use '^' or 'v' keys for changing the previously set value.
- 65) Press the 'SET' key.
If '----' displayed, then it is confirmed that the set value was stored in the memory.
- 66) Press 'SET' key.
- 67) EP will be displayed. EP is for end programming.
- 68) Press 'SET' key again. Then the controller goes to normal display mode and it will display temperature and RH only.

3.6.2 Sensors

Sensors are used for measuring parameters inside the greenhouse which are the input to the microcontroller. Based on this and pre-set threshold values microcontroller operates the actuators attached to it. This automation system includes a temperature sensor and a relative humidity sensor.

3.6.2.1 Temperature Sensor

The temperature sensor used for measuring the temperature inside the greenhouse was RTD sensor. It was installed at the centre of the greenhouse and was connected to the controller. Based on the sensed temperature, the controller manages the temperature inside the greenhouse.

3.6.2.2 Relative Humidity Sensor

Relative humidity sensor used for the study was SZ-HS100. It was installed at the centre of the greenhouse. At the centre of the greenhouse, microclimate conditions are the average value of it at different parts of the greenhouse. The sensor was connected to the controller and based on that controller manages temperature and relative humidity inside the greenhouse.

3.6.3 Exhaust Fans

Exhaust fans were used for the air exchange of greenhouse with that of outside. Whenever the temperature goes above the level of maximum set point the exhaust fans will operate. If the relative humidity is above the level of the maximum level set in the microcontroller, it will operate the exhaust fans until the RH inside is below the set point. Plate 9 shows the exhaust fans used for the air exchange of greenhouse. The specifications of the exhaust fans are given in Table 3.3

Table 3.3 Specifications of exhaust fans

Sweep	200 mm
Voltage	230 V
Frequency	50 Hz
Phase	Single phase
Power ratings	80 watts
Revolutions	2000 rpm

3.6.4 Foggers

Four way foggers of 4 kg cm^{-2} were used for evaporative cooling inside the greenhouse. They were fitted at 1.5 m x 1.5 m spacing inside the greenhouse and were operated using a solenoid valve. The water tank which is supplying water to the fogger is located at a level difference of 50 m. Hence no additional pump is required for operation of fogger. The foggers in operation are shown in Plate 5. The microcontroller operates the solenoid valve for operation of foggers whenever needed based on the temperature and relative humidity. When the temperature inside the greenhouse is above the maximum allowable set value of 37°C and if the RH inside the greenhouse is less than 65%, then the foggers will work along with exhaust fans until the temperature inside the greenhouse lowers

to the minimum set value of temperature. At that point of time the evaporative cooling system will be switched off by the microcontroller. If the temperature and RH inside the greenhouse are above the set value then initially the exhaust fans will be switched on first. Due to the operation of exhaust fans the RH inside the greenhouse will be lowered down and when it is less than the maximum level, the foggers will start working. Thus the RH inside the greenhouse will be managed within the desirable limit while operating the evaporative cooling system.

3.6.5 Transformers

Different transformers were used in the automation system. Transformers are electrical devices which lower and enlarge voltage. This device works through the principle of electromagnetic induction. Based on this principle transformer transfers electrical energy between circuits.

The different transformers used in this automation system include one 9-0 V, 3A transformer for supplying power to controller, 12-0, 2A transformer for supplying power to bubblers and two numbers of 12-0-12V, 3A transformer to supply power to timer and solenoid valves.

3.6.6 Relays

Relay is an electromechanical switch. It can turn ON and OFF the device without human intervention. Parts of relay are an induction coil, two switch positions such as normally open (NO) and normally closed (NC) and a spring swing terminal. The connection (C) of the relay will be either connected to NC or NO through the spring swing lever. During operation, the induction coil of the relay creates a magnetic field, while current flows through it and these changes the contact between NC and NO. If the induction coil is not magnetized, current flows through NC; and if it is magnetized, current flows through NO. This is the working of the relay. In the automation system single relay boards and four channel relay boards were used. One of the single relay boards was used for operation of control system. The automation system operates the actuators only

during night. This is by connecting the control system through a single relay and a solar panel. The solar panel supplies 12V power supply and based on that, the relay will switch on and off the control system. The exhaust fans, solenoid valves for foggers, bubblers, led level indicators, fertilizer injection pumps and solenoid valve for drip irrigation were connected through relays.

3.6.7 Voltage Regulator

There is requirement of voltage regulator to regulate the power supply from 12V DC to 3.3V, 5V, 9V and 12V and for that a voltage regulator used in the automation system.

3.6.8 Rectifiers

For the conversion of AC to DC rectifiers are used in the automation system.

3.6.9 Solenoid Valves

Solenoid valves used were electromechanical valves. These types of valves are used in automation system to on and off automatically. These types of valves have a solenoid in it and it operates the valve. Solenoid valves will be in closed condition until it is energized, and when it is energized the valve will be in open position. It is based on the signals from the controller solenoid valves operate. For the present automation system 2.5 cm solenoid valve and 5 cm solenoid valves are used. 5 cm Solenoid valve are used to switch ON and OFF foggers. Based on the temperature and relative humidity inside the greenhouse, the controller operates the solenoid valve in the fogger main line and thus automatically operating the fogger. The drip irrigation system is also automatically operated through a 5cm solenoid valve. In the main line there is a 5cm solenoid valve which is operated by the timer. 2.5 cm solenoid valves were used for filling water to fertilizer tanks based on the water level in fertilizer tanks.



Plate 5. Foggers in operation



Plate 6. Fertilizer tanks

3.6.10 Timer

The refined automation system controls irrigation and fertigation simultaneously. Irrigation and fertigation are automatically done with the help of a timer in the automation system. This timer controls the fertilizer injector pumps and the solenoid valve in the main line of drip irrigation. Based on the pre set timings the timer operates the fertilizer injection pumps and drip irrigation system. The timer has eight output slots and on each slot one device can be connected. In the present automation system first three slots were connected to fertilizer injection pumps and the fourth one to the solenoid valve in the drip line.

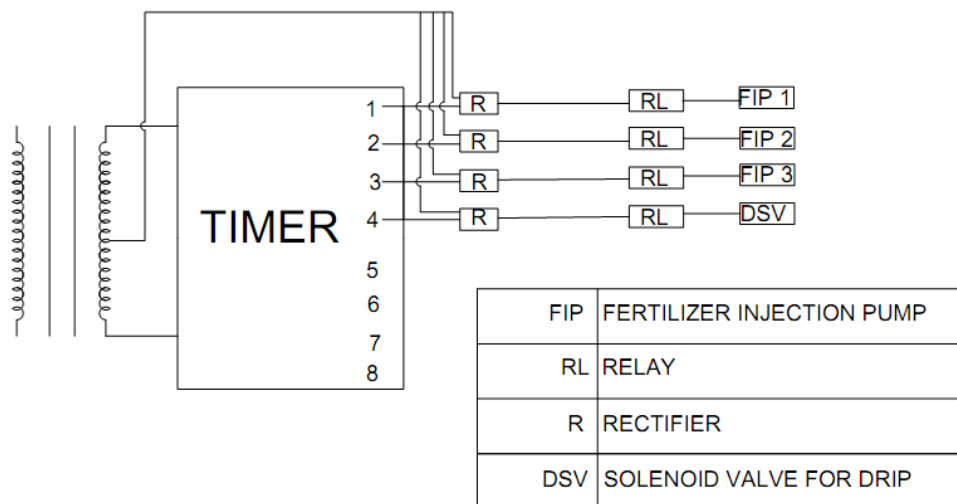

Fig. 3.2 Connection diagram of the timer

1. The first slot of the timer, T1 was used to control fertilizer injection pump1 and bubbler 1.
2. The second slot of the timer,T2 was used to control fertilizer injection pump 2 and bubbler 2.

3. The third slot of the timer, T3 was used to control fertilizer injection pump 3 and bubbler 3.
4. The fourth slot of the timer, T4 was used to control drip irrigation inside the greenhouse.
5. Slot 5-8 of the timer stations, T5-T8 are the slots for installing additional instruments.

3.6.10.1 Timer Operation

Automatic irrigation and fertigation was controlled by a timer in the automation system. Based on the pre-set timings timer operates the fertilizer injector pumps and the solenoid valve for drip irrigation. Timer has different keys to set the time schedule of different operations. Plate 7 shows the different keys of the timer. The operations of the keys are explained below.



Plate 7. Timer used for irrigation and fertigation automation

AUTO key – For the setting of the timer in automatic mode this key is used. In auto mode automatically irrigation and fertigation can be done.

OFF key- The use of OFF key is for the cancellation of the active automatic irrigation and fertigation. The set programmes will remain in the memory of the timer even if we used this key. The saved settings will be in memory if there is any power supply failure also.

Date/ Time key –The date and time in the timer was set by this key.

Next key- This key was used for the selection of programme.

Back key - This key was also used for the selection of programme.

+ key - Adjustment of settings was done by this key.

- key - This key was also used for the adjustment of settings .

Adjustment key - The addition or reduction of duration of time for all the timer stations (zones – T1-T8) were done by this key.

Schedule key –Scheduling the different operations at specific times were done by this key.

Manual key –Irrigation or fertigation were manually done by this key.

3.6.11 Fertilizer Injector Pump

Fertigation was done by using fertilizer injector pumps. Three fertilizer injector pumps were used to pump the fertilizer from three different tanks containing fertilizer solutions. The fertilizer injection pumps were calibrated and the time required for each fertilizer pump was determined and it was set in the timer and based on this pre set values fertilizer pumps will operate. The fertilizer injection pumps pump the fertilizer to the drip line. Whenever the fertilizer injection pumps work, the drip valve also will be in open position. Thus fertilizer goes along with water to the plant root zone. Specifications of fertilizer injection pumps used is given in Table 3.4

Table 3.4 Specifications of Fertilizer Injection Pumps

Voltage	230 V AC
Frequency	50 Hz
Size of suction and delivery	4 mm
Discharge rate	10 lph
Pressure	4 kg cm ⁻²
Strokes	400 minute ⁻¹

3.6.12 Fertilizer Tanks

Concentrated fertilizer solution was stored in three fertilizer tanks and capacity of the tanks used was 50 litres. There are level sensors attached to this fertilizer tanks. Required fertilizer was given to each fertilizer tanks and then water was filled for making fertilizer solution. Water was added to the fertilizer tanks by operating the solenoid valves by using a push button switch. The opening of solenoid valves can only be done when the tank is empty. Fertilizer tanks are shown in Plate 6

3.6.13 Level Controllers

These are a set of relays which control the solenoid valves of the fertilizer tanks. This allows the fertilizer injection when there is fertilizer in the tank and it controls the fertilizer injection pumps.

3.6.14 Push Button Switch

Three push button switches were provided for operating the solenoid valves to fill water in the fertilizer tanks.

3.6.15 Float Switch

The fertilizer solution level in the tank was sensed by float switch to check whether it is empty or full. These float switches send the water level (either empty or full) to the water level indicator and push button switch. Based on the water level inside the tank sensed by float switch, water level indicator shows green or red signal. Green signal when tank is filled and red signal when tank is empty. When the tank is full, it cuts the power to push button switch for filling water to the tank and power supply will be restarted when the tank is empty. The specifications of float switch is given in Table 3.5

Table 3.5 Specifications of float switch

Voltage range	110V to 240V
Current	15 A
Capacity	1HP

3.6.15 Bubblers

Fertilizer solutions inside the fertilizer tanks are to be agitated before fertigation. Bubblers are used for this purpose and are controlled by timer through the relay.

3.6.16 Water Level Indicators

Fertilizer solution level inside the fertilizer tanks can be judged through the water level indicators. When the tank is full its respective green indicator will be on. Thus without opening the tank fertilizer level can be observed.



Plate 8. Solar panels



Plate 9. Exhaust fans

3.6.17 Solar Panel

Uninterrupted power supply is required for the operation of the automation system. Moreover the automation system is to be automatically put off during night hours. For this purpose solar panels were used in the system. Plate 8 shows the solar panels used for the automation system.

3.6.18 Battery

Solar panel receives solar energy and produces solar power and it was stored in a 150 AH 12 V battery.

3.6.19 Solar Power Generator

For converting the solar power to 230 V, 550 W, solar power generator was used.

3.6.20 Wooden Casing

The controller, relays, timer, level indicators, transformers were enclosed in a wooden casing. The size of the casing was 70 x 70 x 28 cm. An exhaust fan was fitted on the casing to avoid unnecessary temperature rise due to working of automation system.

3.6.21 Drip Irrigation System

Drip irrigation system was installed inside the greenhouse to irrigate crops inside the greenhouse. Water source was an overhead tank and the level difference between greenhouse and water tank was 50 m, hence there was no need of additional pump for the drip system. The emitters used were 8 lph capacity arrow drippers. 63mm diameter PVC pipe of 6 kg/cm² were used as main pipes 50 mm diameter 6 kg/cm² PVC pipes were used sub mains. Lateral used were 16 mm LDPE and micro tube was of 6mm LDPE pipes. One drip emitter was provided at each poly bag to irrigate the plant. Drip irrigation was done four times a day. It was operated by a solenoid valve in automated greenhouse. In non automated

greenhouse and at outside, valves were manually operated to do the drip irrigation.

3.7 WORKING OF THE FERTIGATION AUTOMATION SYSTEM

Irrigation and fertigation was automated by timer. After calibration, time required by each fertilizer injection pump was worked out and was set on the timer accordingly. Timer stations T_1 , T_2 and T_3 was used for tanks 1, 2 and 3, respectively. Based on the pre-set timings timer operates the FIP's of respective tanks if they are not empty. Respective bubblers and drip also will be switched on by the automation system. Whenever T_1 gets activated based on pre-set timings and if the fertilizer solution in the tank1 is not empty, fertilizer injection pump1 and bubbler1 will be activated. At the same time drip valve also will be activated through the relay. Similarly when T_2 gets activated and if there is fertilizer solution in fertilizer tank2, fertilizer injection pump2 and bubbler2 of the tank 2 and the drip valve gets activated. In the same way when T_3 gets activated according to the pre-set timings and if the fertilizer tank3 is not empty, fertilizer injection pump3 and bubbler3 gets activated. The drip valve also open to allow water to flow throw it. The drip valve is connected to timer station T_4 . Drip irrigation was done four times in a day; 8.30 AM, 11.30 AM, 2.30 PM and at 5 PM. The fertilizer levels in the tanks were checked by level sensors/ float switch. It could be observed through the water level indicators provided on the panel board.

3.8 CALIBRATION OF FERTILIZER INJECTION PUMPS

The fertilizer injection pumps were calibrated before starting the experiment. This was done by pumping using the fertilizer injection pumps for one minute and the discharge from the fertilizer injection pump was collected in a container and measured. The procedure was repeated thrice and the average value was taken as the discharge rate from the fertilizer injection pumps. All the three fertilizer injection pumps were calibrated separately before the start of

experiment. The calibration was repeated before the start of second and third crop season also. This average time was set in timer station T1, T2 and T3 for operating fertilizer injection pumps. Whenever fertilizer injection pumps works, irrigation valve will also automatically open. The discharge obtained during the calibration of fertilizer injection pumps were given in Tables 3.6, 3.7 and 3.8.

Table 3.6 Discharge rate of fertilizer injector pumps during first crop season

	FIP 1 (ml/min)	FIP 2 (ml/min)	FIP 3 (ml/min)
Test 1	200	210	195
Test 2	205	205	180
Test 3	190	210	185
Average	198	208	187

Table 3.7 Discharge rate of fertilizer injector pumps during second crop season

	FIP 1 (ml/min)	FIP 2 (ml/min)	FIP 3 (ml/min)
Test 1	195	185	180
Test 2	200	195	185
Test 3	190	185	180
Average	195	188	182

Table 3.8 Discharge rate of fertilizer injector pumps during third crop season

	FIP 1 (ml/min)	FIP 2 (ml/min)	FIP 3 (ml/min)
Test 1	210	180	190
Test 2	185	195	185
Test 3	190	185	190
Average	195	187	188

3.9 FERTIGATION SCHEDULING

Based on the fertilizer recommendation of the crop for 1ha as per package of practices (PoP) published by Kerala Agricultural University (KAU), requirement of fertilizer for the crop was worked out separately for crops cultivated inside automated greenhouse, non automated greenhouse and crop outside the greenhouse. For 1 ha the recommended requirements are 104 kg NH_4NO_3 , 40 kg 12-61—0 and 55 kg SOP. As per recommended spacing of 2 m x 1 m number of plants in 1 ha is 3333 plants and based on that fertilizer requirement of each plant calculated. The calculated requirement of each plant were 0.031 kg NH_4NO_3 , 0.012 kg 12-61—0 and 0.017 kg SOP. Total amount of NH_4NO_3 required were 5.766 kg for AGH, 0.93 kg for NAGH and OGH. the requirement of 12-61-0 2.232 kg for AGH, 0.36kg for NAGH and OGH and SOP requirement were 3.162 kg for AGH, 0.51 kg for NAGH and OGH. These fertilizers were applied in 24 split dozes. Fertigation was done automatically in automated greenhouse and manually applied in NAGH and OGH. Total fertilizer required for each treatment was given in split doses with one fertigation in three days. Total fertilizer solution required for fertigation was found out for each fertilizer tank. The required time for each fertilizer injection pump was found out and fed to timer station based on calibration. The requirement of fertilizer for crop is different for different growth periods. Hence the time allotted for fertigation was changed in the timer according to the growth stage and requirement of the crop. Whenever fertigation was done, the drip valve also will be activated. Drip irrigation was done four times in a day such as 8.30AM, 11.30AM, 2.30PM and at 5PM for a period duration of 5 minutes. This time was set in timer station 1 in the timer and daily irrigation was thus done automatically in automated greenhouse, whereas in NAGH and OGH drip irrigation was done manually.

3.10 EXPERIMENTAL SETUP

3.10.1 Greenhouse

The refined automation system was installed in a naturally ventilated greenhouse and its performance evaluation was carried out without any crop inside the greenhouse and with salad cucumber crop inside the greenhouse. Observations were taken from a non automated greenhouse also for the comparison of the collected data. Pillars, arches and purlins of the greenhouse were made of B class GI pipes. Cladding material used was 200 micron Ultra Violet (UV) stabilized polythene sheets. Sides were covered by 40 mesh insect proof nets. The specifications of the experimental greenhouse is given Table 3.9

Table 3.9 Specification of the selected greenhouses

Height at centre	6.5 m
Height at both sides	4 m
Floor area	291.9 m ²
Pillars	63 mm GI pipe (Class B)
Arch	40 mm GI pipe (Class B)
Cladding material	UV stabilized polythene sheet of 200 micron thickness
Sides	Insect proof nylon net of 40 mesh

3.10.2 Crop Cultivated Inside the Greenhouse

Saniya variety of salad cucumber was cultivated inside the automated greenhouse to evaluate the performance of the automation system. Saniya is a parthenocarpic salad cucumber variety. For comparison, the same crop was cultivated inside non automated greenhouse and outside the greenhouse. Seeds were sown in pro trays containing mixture of vermicompost and coir pith in 1:1

ratio to a depth of 0.5 cm. One week after germination, seedlings were transplanted in AGH, NAGH and OGH.

3.11 EXPERIMENTAL PROCEDURE

Performance evaluation of the refined automation system was done after installing it in a naturally ventilated greenhouse. Performance of the automation system was first evaluated without any crop inside the greenhouse. Microclimate parameters such as temperature, relative humidity and intensity of solar radiation measured inside and outside the greenhouse were monitored for one week. After that automation system performance was studied by cultivating crop inside the greenhouse. Saniya variety of cucumber crop was used for this purpose. The cultivation was done in poly bags. In the automated greenhouse half of the greenhouse was used for cucumber cultivation. A total of 186 plants were cultivated in automated greenhouse and 30 each in non automated greenhouse and outside the greenhouse. Biometric and yield observations were taken from the randomly selected fourteen plants each from AGH, NAGH and OGH. In AGH, plants were cultivated in seven rows (27 plants in six rows and 24 plants in one row). In NAGH 30 plants were cultivated in a single row and 30 plants were cultivated in OGH (6 plants each in five rows). All the plants were cultivated in grow bags of size 24 x 24 x 40 cm. Potting mixture prepared by soil, coir pith and dried farm yard manure in the ratio 2:1:1. Drip irrigation system was installed for the irrigation of crops and arrow drippers of 8 lph were provided in each grow bag. Fourteen plants each from AGH, NAGH and OGH were selected for data collection. The microclimate and crop data of selected plants from AGH, NAGH and OGH were compared to evaluate the performance of automation system. Experiment was conducted for three crop seasons and the microclimatic data as well as crop growth and yield data were collected for all three seasons. The different stages of crop and harvested fruits are shown in Plate 10 to Plate 17.

3.12 FERTIGATION

The required amount of fertilizer for each plant was calculated and total amount of fertilizer required for each treatment was worked out. The fertilizers used were ammonium nitrate ($\text{NH}_4 \text{NO}_3$), mono-ammonium phosphate (12-61-0) and potassium sulphate (K_2SO_4). Required amount of these fertilizers to provide recommended dose was calculated. For automated greenhouse the required amount of fertilizer was filled in respective fertilizer tanks. Fertilizer tank1 was filled with the required amount of ammonium nitrate. Tank 2 was filled with calculated amount of mono-ammonium phosphate and the required amount of potassium sulphate in tank 3. Desired amount of water was also added to tanks to make fertilizer solution of required concentration. The amounts of water filled in tanks are given Table 3.10. Mixing of fertilizer solution was done by bubblers in each tank. Based on the pre-set timings, the fertilizer injection pumps of respective tank will get operational. At the same time bubblers of the same tank and drip valve will be on and fertigation will be done in automated greenhouse. Micronutrients such as calcium nitrate ($\text{Ca} (\text{NO}_3)_2$) were given to the plants through fertigation, for which another tank was used. From that tank micronutrients were given whenever necessary. In NAGH and OGH fertigation was done without using automation system.

Table 3.10 Requirement of water in fertilizer tanks

Season	Water (l) in tanks		
	Tank ₁ (NH_4NO_3)	Tank ₂ (12-61-0)	Tank ₃ (SOP)
1 st season	47.52	49.92	44.88
2 nd season	46.8	45.12	43.68
3 rd season	46.8	44.88	45.12

3.13 PEST AND DISEASE CONTROL

As crops are vulnerable to pest and disease infestations daily surveillance was carried out and remedial measures were taken.. Castor oil coated blue and yellow sticky traps were hung inside AGH, NAGH and OGH for the control of leaf miners and whiteflies. Fish extract @ 2 ml/l was sprayed as a growth promoter. *Malathion* (2ml/l), *Beauveria* (10 g/l), *Pseudomonas* (20 g/l), and *imidacloprid* 0.3 ml/l was sprayed for protection of crop from various pests and diseases. Weeding was done manually during all the three crop seasons.

3.14 FIELD DATA COLLECTION

The microclimate data as well as yield data were collected during all the three crop seasons.

3.14.1 Microclimate Data

Microclimate data collected include temperature, relative humidity and intensity of solar radiation. Temperature and relative humidity were collected by using data logger and solar intensity by using digital lux meter. Hourly microclimate data were collected separately from automated greenhouse, non automated greenhouse and outside the greenhouse from 10 AM to 5 PM. These microclimate data were collected during all the crop seasons. Initially microclimate data inside the automated greenhouse was collected for one week without any crop.

3.14.2 Crop Data

Performance of the automation system was also evaluated by cultivating crop inside the greenhouse and biometric observations and different yield parameters were also collected. Growth and yield data were collected from fourteen randomly selected plants of automated greenhouse, non automated greenhouse and from outside.

3.14.2.1 Biometric Observations

Various biometric observations of the crop inside automated greenhouse, non automated greenhouse and the crop outside the greenhouse were noted.

3.14.2.1.1 Height of the Plant

Measurements of height of the selected plants were done for crops inside the automated greenhouse, non automated greenhouse and the crops outside the greenhouse. Measurements were taken at weekly intervals for first four weeks. These observations were taken for the three crop seasons separately.

3.14.2.1.2 Number of Leaves per Plant

Observation regarding number of leaves per plant was collected for the initial four weeks during all the three crop seasons from automated greenhouse, non automated greenhouse and from crops outside the greenhouse.

3.14.2.1.3 Leaf Length

Lengths of leaves of the selected plants were taken for the crops inside the AGH, NAGH and for the crops outside the greenhouse. This observation was taken at weekly intervals for the initial four weeks during all the three crop seasons.

3.14.2.1.4 Leaf Width

Leaf width of the selected plants inside the AGH, NAGH and OGH were measured during the initial four weeks at weekly intervals. The observations were taken during all the three crop seasons.

3.14.2.1.5 Number of Days Required for First Flower Bud Initiation

Observation on number of days required by the crop to form first flower bud after transplanting inside AGH, NAGH and OGH were taken during all the three crop seasons.

3.14.2.1.6 Number of Days Required for First Flower Formation

Number of days required after transplanting to form first flower by the crop inside the AGH, NAGH and crop outside the greenhouse were noted for all the crop seasons.

3.14.2.1.7 Number of Days Required for 50% Flowering

Number of days required after transplanting to 50% flowering was noted for crops inside AGH, NAGH and OGH during all the three crop seasons.

3.14.2.1.8 Number of Days Required for First Fruit Formation

Number of days after transplanting to first fruit formation was recorded for crops inside AGH, NAGH and OGH. This observation was taken during all the three crop seasons.

3.14.2.1.9 Number of Days Required to First Harvest

The number of days required by the crop to first harvest after transplanting was noted separately for crop inside AGH, NAGH and for crop OGH. The observation was taken during all the crop seasons.

3.14.2.2 Yield Data

Yield data *viz.* weight of fruit, total yield and number of fruits per plant, and size of fruit were collected from the selected fourteen plants from automated greenhouse, non automated greenhouse and outside the greenhouse.



Plate 10. Sowing



Plate 11. Germination stage



Plate 12. Seedlings ready for transplanting

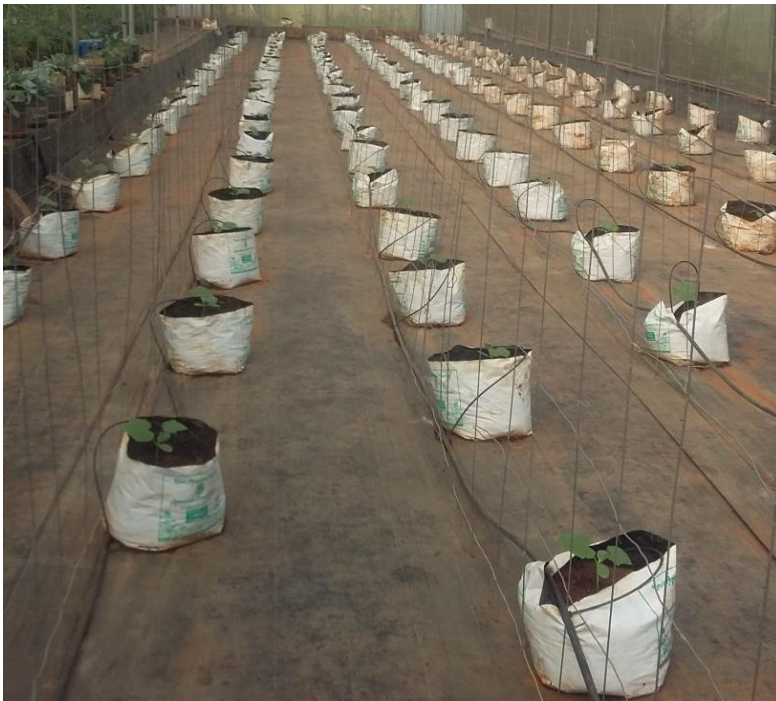

Plate 13. Transplanted seedlings



Plate 14. Bud initiation stage



Plate 15. Flowering stage



Plate 16. Harvesting stage



Plate 17. Harvested fruits (Left side Fruits from AGH and right side from NAGH)

3.14.2.2.1 Number of Fruits/Plant

Harvesting of the cucumber crop was done on every alternate day. Fourteen plants each from automated greenhouse, non- automated greenhouse and outside the greenhouse were selected randomly and tagged and the number of fruits from each plant was recorded during each harvest. The total number of fruits during the entire season from each selected plants was calculated from the observations. These observations were taken during all the three crop seasons.

3.14.2.2.2 Average Length of Fruit

During every harvest the length of fruits of the selected plants from AGH, NAGH and OGH were recorded. The average length of fruit from AGH, NAGH and OGH were calculated. The procedure was repeated during all the three crop seasons.

3.14.2.2.3 Diameter of Fruit

Circumferences of the harvested fruits from the selected plants were measured after every harvest of fruits from AGH, NAGH and OGH. From the circumference measured, diameter was calculated.

Average diameter of fruit was calculated for all the three crop seasons.

3.14.2.2.4 Average Weight of Fruit

Weights of individual fruits were taken after every harvest of the selected plants from AGH, NAGH and OGH. The average weight of fruit was calculated from this data. The procedure was repeated for all the three crop seasons.

3.14.2.2.5 Yield (kg/plant)

The yield data of the selected crops were worked out by harvesting the fruits on every alternate day. The weight of the fruits harvested was recorded using digital weighing balance. Total weight all the fruits from a plant during a

season was then calculated. Average yield per plant from selected plants were calculated for the crop in automated greenhouse, non automated greenhouse and crop outside the greenhouse were calculated. The same procedure was repeated to find the average yield per plant for different crop seasons.

3.15 STATISTICAL ANALYSIS

The collected microclimatic data as well as crop data were analysed statistically using one way ANOVA (Analysis of Variance). The data analysis was done using MS excel. The data from different treatments were checked for significant difference at a probability level $p < 0.05$.

3.16 COST ANALYSIS

The cost of cultivation inside the automated greenhouse, non-automated greenhouse and outside the greenhouse was worked out and cost benefit (CB) ratio was calculated. The prevailing rates of items during the time period of study were used for calculation of total cost of cultivation for different treatments. The cost of greenhouse of 300 m² was considered for the calculation and the life of greenhouse and automation system was taken as 10 years. The cost for cultivating 400 plants inside both the greenhouse was worked out, assuming that three crops can be cultivated in a year. The total yield per plant during the three crops of study period was used for calculating the total income from the crop. Profit during a year was calculated by subtracting the cost from the returns calculated. Calculation of cost benefit ratio was done as suggested by Palaniappan, 1985.

$$\text{Benefit Cost Ratio} = \text{Gross Return} / \text{Total Cost of Cultivation}$$

CHAPTER IV

RESULTS AND DISCUSSION

The refinement of the existing low cost greenhouse automation system was carried out during the period from July 2015 to October 2015. Evaluation of the refined low cost automation system was conducted at Agricultural Research Station, Anakkayam from December 2015 to February 2017. Field evaluation was done by installing the refined automation system in a greenhouse and field data, including microclimate data, biometric observations and yield data were collected by raising salad cucumber inside the greenhouse during three crop seasons. For comparison of the data, salad cucumber was grown in another greenhouse without automation and microclimatic as well as crop data were collected from that greenhouse. The results obtained from the study are discussed in this chapter.

4.1 GREENHOUSE AUTOMATION SYSTEM

Greenhouse automation system not only regulates microclimate inside the greenhouse, but also performs the irrigation and fertigation operations. The system operates the different cooling devices such as exhaust fans and foggers based on pre-set temperature and relative humidity. In the present study the performance of the automation system was evaluated with cucumber crop inside the greenhouse. The temperature set points adopted were 33⁰C as lower limit and 37⁰C as upper limit. The relative humidity set points were 50 % as lower limit and 70% as upper limit. When the temperature rises above 37⁰C and relative humidity is below 70% foggers will start working along with exhaust fans. On the other hand if the relative humidity is above 70 % and temperature is above 37⁰C the exhaust fans alone will work until the relative humidity value is below 65 %. Due to large air entry of exhaust fans the relative humidity value decreases and when it becomes less than 65 %, foggers will also start working along with exhaust fans. When the temperature becomes less than 33⁰C, both foggers as well

as exhaust fans will stop working and if the relative humidity is higher than 70 % working of foggers alone will stop. In this manner the greenhouse automation system regulates microclimate inside the greenhouse within the pre-defined limits.

4.2 AUTOMATIC MICROCLIMATE CONTROL INSIDE THE GREENHOUSE

The automatic microclimate control system worked well inside the greenhouse. During peak hours of the day, microclimate inside the greenhouse was managed by automation system. The automation system managed the temperature inside the greenhouse within the predefined set points and at the same time the relative humidity did not increase beyond the pre-set value of 70 %.

4.2.1 Variation of Microclimate inside the Automated Greenhouse without Crop

The performance of the automation system was tested without crop inside the greenhouse. The weekly average of hourly variation of temperatures from 10 am to 5 pm is shown graphically in Fig.4.1 and the corresponding values are given in Table 4.1.

Table 4.1 Hourly variation of temperature inside the greenhouse without crop

Time	Temperature (⁰C)	
	AGH	OGH
10.00 am	32.2	29.9
11.00 am	35.1	32.8
12.00 noon	36.1	35.1
1.00 pm	36.3	36.1
2.00 pm	36.8	36.5
3.00 pm	36.4	36.1
4.00 pm	35.4	33.9
5.00 pm	35.3	32.7

The data regarding average microclimate variation without crop is given in Appendix I. Mean value of temperature during peak hours (11am to 4 pm) was 36⁰C for automated greenhouse (AGH) and 35.1⁰C for the outside condition. The highest temperature noted outside was 36.5⁰C for outside condition while inside the greenhouse temperature was 36.8⁰C. From the graph it is clear that automation system could regulate the temperature within the greenhouse between 35⁰C and 37⁰C. The variation of relative humidity from 10 am to 5 pm is shown graphically in Fig.4.2 and the corresponding values are given Table 4.2. Mean value of relative humidity during peak hours was (11 am to 4 pm) 66.3 % and 34.2 % for the automated greenhouse and outside condition respectively. The outside relative humidity was reduced to a value of 29 % at 2 pm for the outside condition but in the case of automated greenhouse the relative humidity was maintained above 50 % and below 70 %.

Table 4.2 Hourly variation of RH inside the greenhouse without crop

Time	Relative Humidity (%)	
	AGH	OGH
10.00 am	55	56
11.00 am	63	41
12.00 noon	67	36
1.00 pm	68	32
2.00 pm	70	29
3.00 pm	69	31
4.00 pm	61	36
5.00 pm	57	41

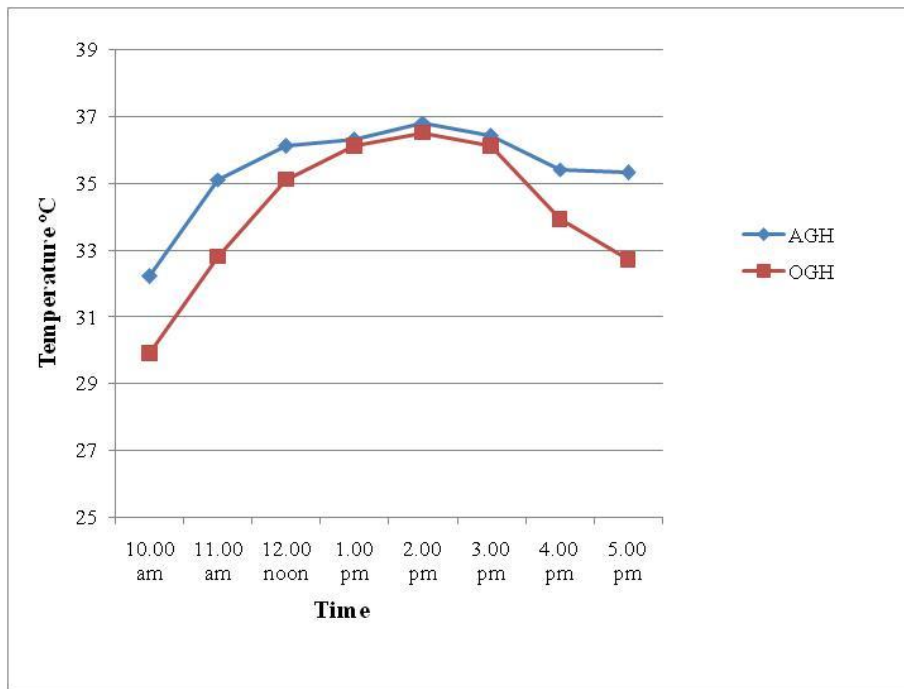

Fig. 4.1 Hourly variation of temperature (°C) inside the greenhouse without crop

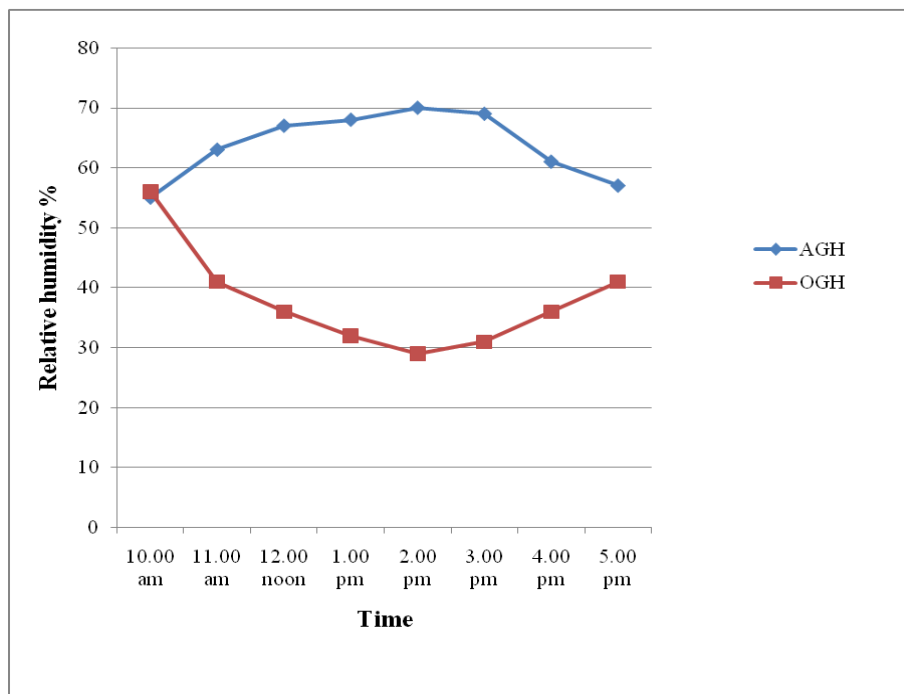

Fig. 4.2 Hourly variation of RH (%) inside the greenhouse without crop

4.2.2 Microclimate Regulation for the First Crop

The hourly average value of the temperature for the first crop season is shown graphically in Fig.4.3 and the corresponding values are given in Table 4.3. Average values of microclimate data for automated greenhouse, non automated greenhouse (NAGH) and ambient condition during first crop season is given in Appendix II. Outside temperature was 31.8⁰C at 10 am and it increased to a value of 37.6⁰C by 2 pm and then decreased to 33.4⁰C by 5 pm. The highest values of temperatures were noticed between 1 pm to 2 pm. In the automated greenhouse temperature was 33.9⁰C at 10 am and it did not increased beyond 37.8⁰C even during peak hours. In non automated greenhouse, the temperature was 34.3⁰C at 10 am and increased up to 43.2⁰C by 2 pm and then decreased to 35.6⁰C by 5pm. The data showed that in the non- automated greenhouse, during peak hours (from 11am to 4pm), temperature is above 38⁰C and it increased to more than 43⁰C. But in automated greenhouse it never increased more than 37.8⁰C even during peak hours. Even though the maximum temperature set was 37⁰C, the temperature slightly increased to more than that because of the time lag given in the controller for avoiding continuous operation of foggers. The average value of relative humidity variation for the first crop season is shown in Fig.4.4 and the corresponding values are given in Table 4.4. In the automated greenhouse (AGH) the relative humidity values were between 56 % to 69 % and at the same time outside relative humidity was 51 % at 10 am and it reduced to a lower value of 28 % at 2 pm and again increased to 43 % at 5 pm. During peak time that is during 11 am to 4 pm the relative humidity values were below 40% outside the greenhouse. In the non automated greenhouse (NAGH), the relative humidity was 45 % at 10 am and decreased to 33 % at 2 pm and again increased to 48 % at 5 pm. The data showed that, in non automated greenhouse during peak time of the day, relative humidity values were less than 40 %. Mean values of temperature and relative humidity are given in Table 4.5. One way ANOVA test conducted and resulted that there was significant difference temperature between AGH and

NAGH but there was no significant difference between mean temperature of AGH and OGH. Also there was significant difference of relative humidity between AGH and NAGH and AGH and OGH but there was no significant difference between relative humidity in NAGH and OGH. Because of the timely operation of actuators the temperature inside the AGH was reduced and the RH increased also. From these, we can conclude that the automation system maintained the temperature and relative humidity within the desired limits of crop cultivated inside the greenhouse.

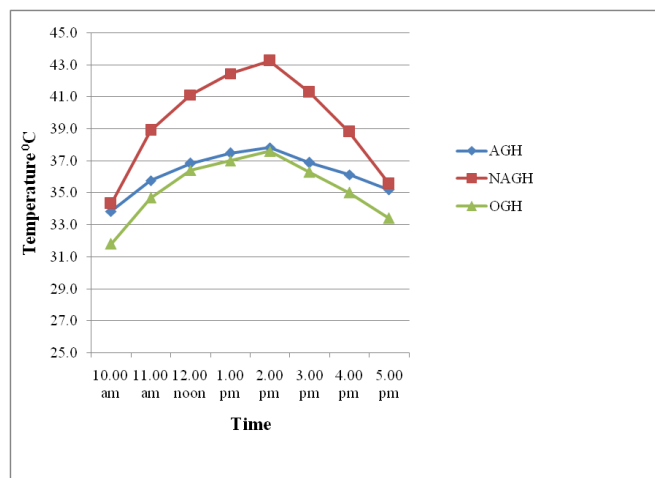

Fig. 4.3 Hourly variation of seasonal average temperature (°C)

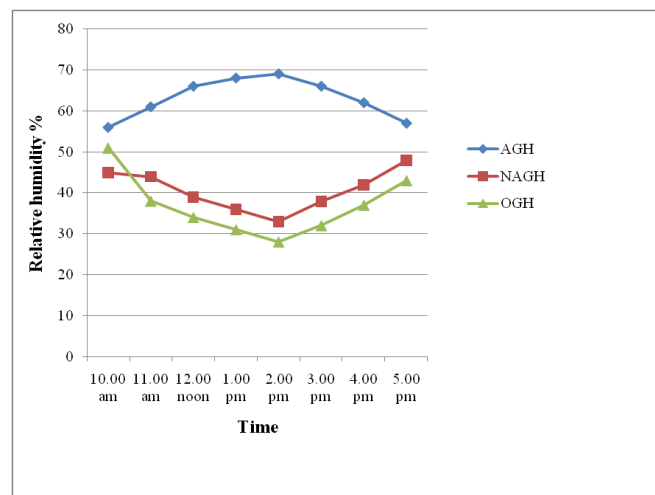

Fig. 4.4 Hourly variation of seasonal average relative humidity (%)

Table 4.3 Seasonal average of hourly temperature during first season inside AGH, NAGH and OGH

Time	Temperature (⁰ C)		
	AGH	NAGH	OGH
10.00 am	33.8	34.3	31.8
11.00 am	35.8	38.9	34.7
12.00 noon	36.8	41.1	36.4
1.00 pm	37.5	42.4	37.0
2.00 pm	37.8	43.2	37.6
3.00 pm	36.9	41.3	36.3
4.00 pm	36.1	38.8	35.0
5.00 pm	35.2	35.6	33.4

Table 4.4 Seasonal average of hourly RH during first season inside AGH, NAGH and OGH

Time	Relative Humidity (%)		
	AGH	NAGH	OGH
10.00 am	56	45	51
11.00 am	61	44	38
12.00 noon	66	39	34
1.00 pm	68	36	31
2.00 pm	69	33	28
3.00 pm	66	38	32
4.00 pm	62	42	37
5.00 pm	57	48	43

Table 4.5 Mean value of temperature and RH from 10 am to 5 pm during 1st season

	Temperature ⁰ C	RH %
AGH	36.2 ^a	63.1 ^a
NAGH	39.5 ^b	40.6 ^b
OGH	35.3 ^a	36.8 ^b

*Values followed by same letters are not significantly different at P<0.05

4.2.2.1 Microclimate Regulation inside the Greenhouse for 1st Month (December 2015) during 1st Crop Season

The average monthly variation of temperature inside the greenhouse is shown graphically in Fig.4.5 and corresponding values are given in Table 4.6. Average values of microclimate data for the first month of first crop season is shown in Appendix III. The average temperature at 10 am in the automated greenhouse was 32.8⁰C, while it was 33⁰C in the non automated greenhouse and 30.3⁰C at outside. Outside temperature varied from 30.3⁰C at 10 am and increased to a value of 36.5⁰C at 2 pm, thereafter decreased to 32.5⁰C at 5 pm. In the case of non automated greenhouse the corresponding temperatures were 33⁰C, 41.7⁰C and 35.1⁰C, respectively. But in the case of automated greenhouse the temperature was 32.8⁰C at 10 am and 34.9⁰C at 5 pm. During peak hours the temperature inside the greenhouse was maintained between 35⁰C and 37⁰C by the automation system. The variation of relative humidity for first month after transplanting is shown graphically in Fig.4.6 and the corresponding values are given in Table 4.7.

Table 4.6 Average temperatures during December 2015

Time	Temperature (⁰C)		
	Automated Greenhouse	Non Automated Greenhouse	Outside
10.00 am	32.8	33.0	30.3
11.00 am	35.3	37.6	33.2
12.00 noon	36.2	39.4	35.4
1.00 pm	36.5	40.7	36.1
2.00 pm	36.7	41.7	36.5
3.00 pm	36.4	40.1	35.6
4.00 pm	35.8	37.4	33.9
5.00 pm	34.9	35.1	32.5

The average monthly value of relative humidity at outside was 55 % at 10 am and it reduced to 30 % at 2 pm, thereafter increased to 43% at 5 pm and in non automated greenhouse the corresponding values were 50%, 34% and 50%, respectively. During peak hours, the values were less than 40 % in the case of outside and near or less than 40 % in non automated greenhouse also. But in the case of automated greenhouse the relative humidity was maintained between 50 % and 70 % which is the desired limit for the crop inside the greenhouse. Mean value of temperature and relative humidity from 10 am to 5 pm during December 2015 are given in Table 4.8. One way ANOVA test resulted that there was significant difference of mean values of temperature between AGH and NAGH but there was no significant difference between AGH and OGH. There was significant difference between mean temperature of NAGH and OGH. Likewise there was significant difference of RH between AGH and NAGH and AGH and OGH but there was no significant difference between NAGH and OGH. This was because of the better microclimate management of automation system in AGH.

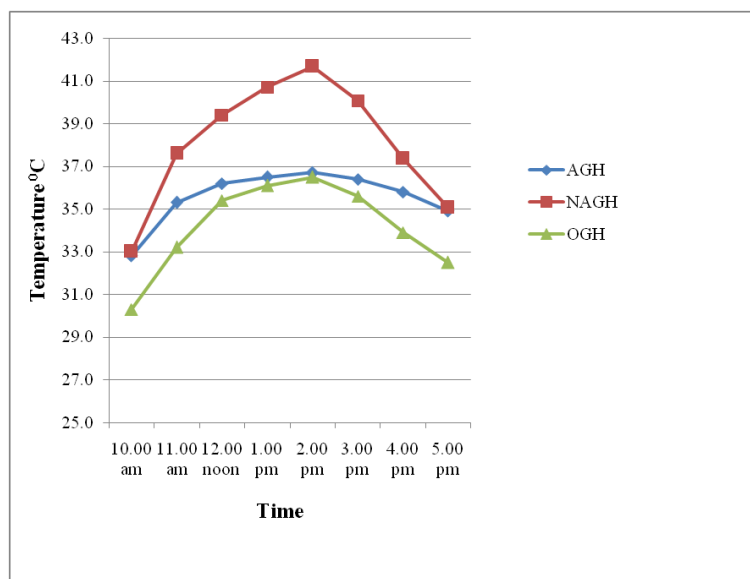

Fig. 4.5 Hourly variation of temperatures (°C) during December 2015

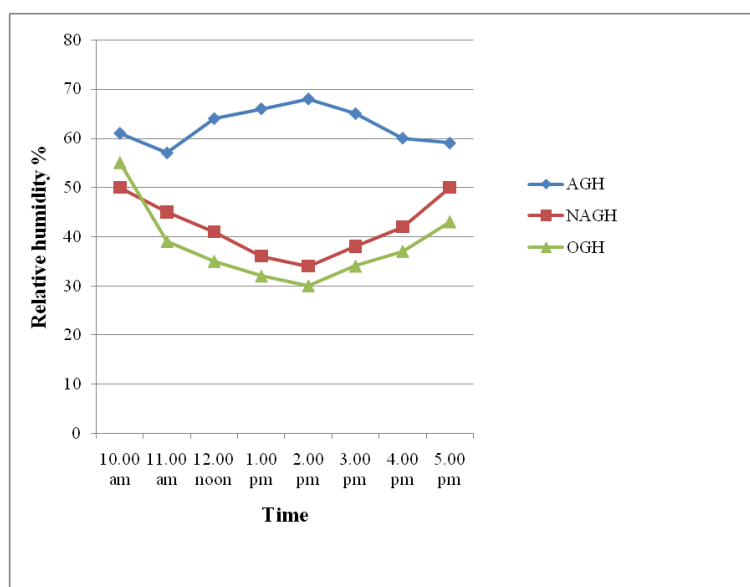

Fig. 4.6 Hourly variation of RH (%) during December 2015

Table 4.7 Average RH during December 2015

Time	Relative Humidity (%)		
	AGH	NAGH	OGH
10.00 am	61	50	55
11.00 am	57	45	39
12.00 noon	64	41	35
1.00 pm	66	36	32
2.00 pm	68	34	30
3.00 pm	65	38	34
4.00 pm	60	42	37
5.00 pm	59	50	43

Table 4.8 Mean value of temperature and RH from 10 am to 5 pm during December 2015

	Temperature ⁰ C	RH %
AGH	35.6 ^a	63 ^a
NAGH	38.1 ^b	42 ^b
OGH	34.2 ^a	38 ^b

*Values followed by same letters are not significantly different at P<0.05

4.2.2.2 Micro climate Regulation inside the Greenhouse for 2nd Month (January 2016) during 1st Crop Season.

The temperature comparison for January 2016 is shown in Fig.4.7 and the corresponding values are given in Table.4.9. The temperature readings at 10 am were 32.7 °C for automated greenhouse, 33.4 °C for non automated greenhouse and 31 °C for outside condition. The temperature inside the non automated greenhouse increased to a value of 42 °C at 2 pm and reduced to 35.1 °C at 5 pm, while inside the automated greenhouse, temperature never increased above 37 °C and maximum temperature was 37 °C during peak hours. Outside temperature increased to a value of 36.9 °C at 2 pm and decreased to 33 °C at 5 pm. Graph corresponding to automated greenhouse clearly indicates the effect of temperature regulation inside that greenhouse. The average values of microclimate data is shown in Appendix IV. The variation of relative humidity in automated greenhouse, non automated greenhouse and outside condition are shown graphically in Fig.4.8 and the corresponding values are given in Table 4.10. The relative humidity inside automated greenhouse was maintained between 50 % and 70 % while in the case of non automated greenhouse RH value was 46 % at 10 am and it then decreased to 34 % at 2 pm, thereafter gradually increased to 48 % by 5 pm. The outside RH was 50 % at 10 am and it gradually reduced to 30 % by 2pm and then gradually increased to 42 % by 5pm. From Fig. , 4.7 and 4.8 it is clear that during peak hours the automation system maintained the temperature and RH inside the automated greenhouse within the desired limits of the crop. Mean values of temperature and RH from 10 am to 5 pm are given in Table 4.11. One way ANOVA resulted that there was significant difference in temperature between AGH and NAGH but there was no significant difference between AGH and OGH. There was significant difference between NAGH and OGH. There was significant difference between relative humidity between AGH and NAGH and also between AGH and OGH. All these results indicate the better microclimate management in AGH compared to NAGH.

Table 4.9 Average temperature during January 2016

Time	Temperature (⁰ C)		
	Automated Greenhouse	Non Automated Greenhouse	Outside
10.00 am	32.7	33.4	31.0
11.00 am	35.2	37.7	34.1
12.00 noon	36.0	39.7	35.6
1.00 pm	36.8	41.3	36.2
2.00 pm	37.0	42.0	36.9
3.00 pm	36.4	40.1	35.5
4.00 pm	35.9	37.8	34.6
5.00 pm	35.1	35.1	33.0

Table 4.10 Average RH during January 2016

Time	Relative Humidity (%)		
	AGH	NAGH	OGH
10.00 am	54	46	50
11.00 am	59	48	44
12.00 noon	63	42	38
1.00 pm	67	39	36
2.00 pm	69	34	30
3.00 pm	65	39	34
4.00 pm	61	42	37
5.00 pm	56	48	42

Table 4.11 Mean value of temperature and RH from 10 am to 5 pm during January 2016

	Temperature ⁰ C	RH %
AGH	35.6 ^a	62 ^a
NAGH	38.4 ^b	42 ^b
OGH	34.6 ^a	39 ^b

*Values followed by same letters are not significantly different at P<0.05

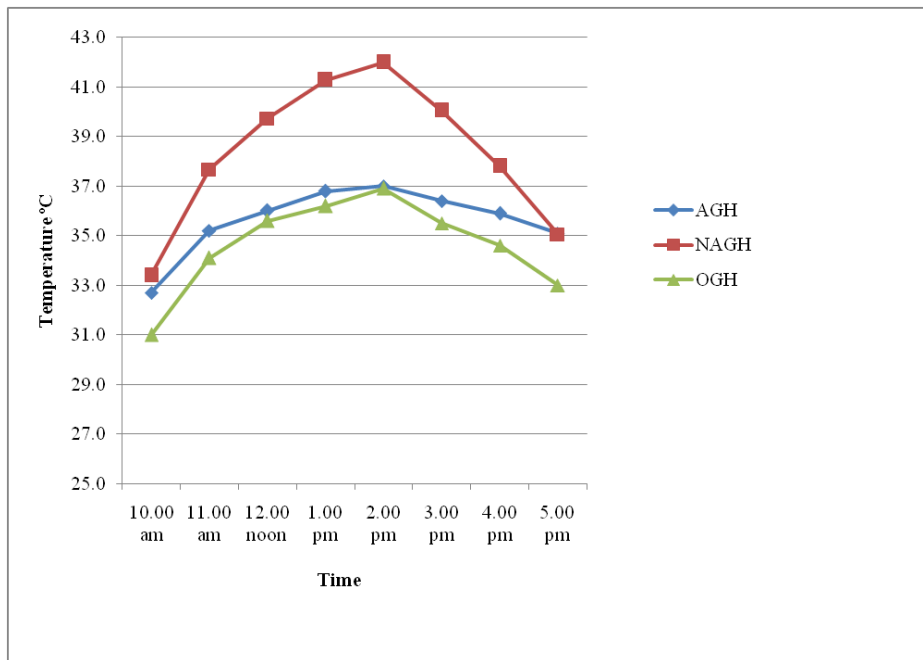

Fig. 4.7 Hourly variation of temperature (°C) during January 2016

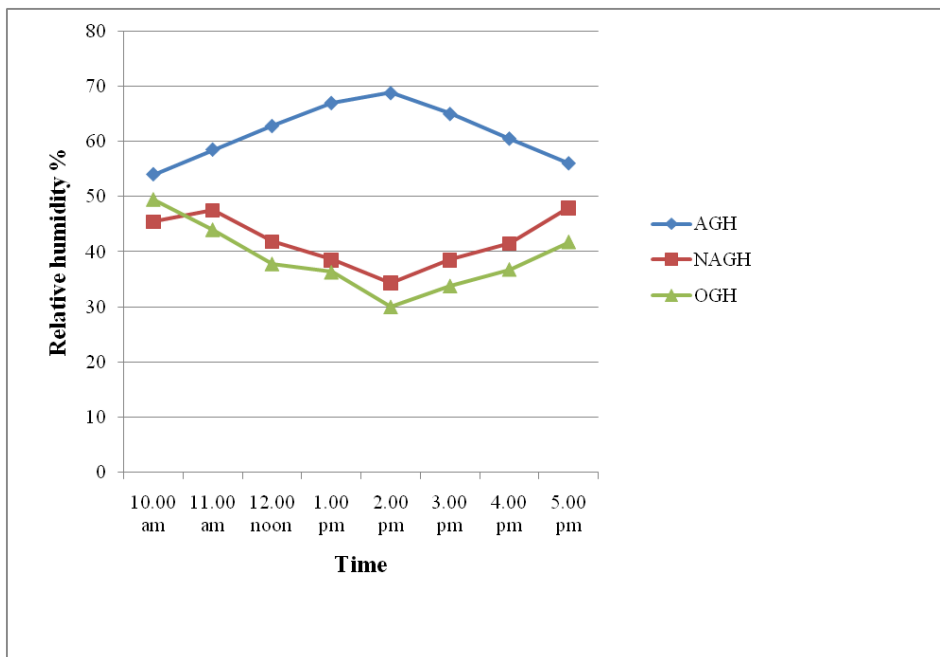

Fig. 4.8 Hourly variation of RH (%) during January 2016

4.2.2.3 Microclimate Regulation inside the Greenhouse for 3rd Month (February 2016) During 1st Crop Season

Variation of average temperatures for 2016 February is shown in Fig.4.9 and the corresponding values are given in Table 4.12. Maximum temperature noted inside the automated greenhouse was 37.9⁰C while in the non automated greenhouse it increased up to 43.5⁰C. During peak hours (from 11 am to 4 pm), the temperature inside the non automated greenhouse was above 38⁰C, which is above the desirable range for cucumber crop. But in the automated greenhouse, temperature was maintained below 38⁰C. The monthly average outside temperature was 31.9⁰C at 10 am which gradually increased to 37.7⁰C by 2 pm, thereafter decreased to 33.5⁰C by 5 pm. Between 12 noon and 3 pm, the temperature outside the greenhouse was above 37⁰C and because of that temperature inside the AGH was slightly higher than the maximum set point. This is because foggers work only when the RH becomes less than 70 %. As the time lag provided between stop and start cycle of foggers was five minutes, there was slight increase of temperature above 37⁰C. The average values of microclimate data inside automated greenhouse, non automated greenhouse and outside ambient condition for the February 2016 is given in Appendix V. Variation of RH for February 2016 is shown graphically in Fig.4.10 and the corresponding values are given in Table 4.13. Outside RH was 50 % at 10 am and it decreased to 28 % by 2 pm and thereafter increased to 46 % by 5pm. The RH inside the non automated greenhouse decreased from 45 % at 10 am and to 34 % at 2 pm and thereafter increased to 50 % by 5 pm. In the automated greenhouse, the RH was maintained between 50 % and 70 % during day time which is within the desirable limit for the crop. Mean values of temperature and RH from 10 am to 5 pm are given in Table 4.14. One way ANOVA resulted that there was significant difference in temperature between AGH and NAGH but there was no significant difference between AGH and OGH. There was significant difference between NAGH and OGH. There was significant difference between relative

humidity between AGH and NAGH and also between AGH and OGH. All these results indicate the better microclimate management in AGH compared to NAGH.

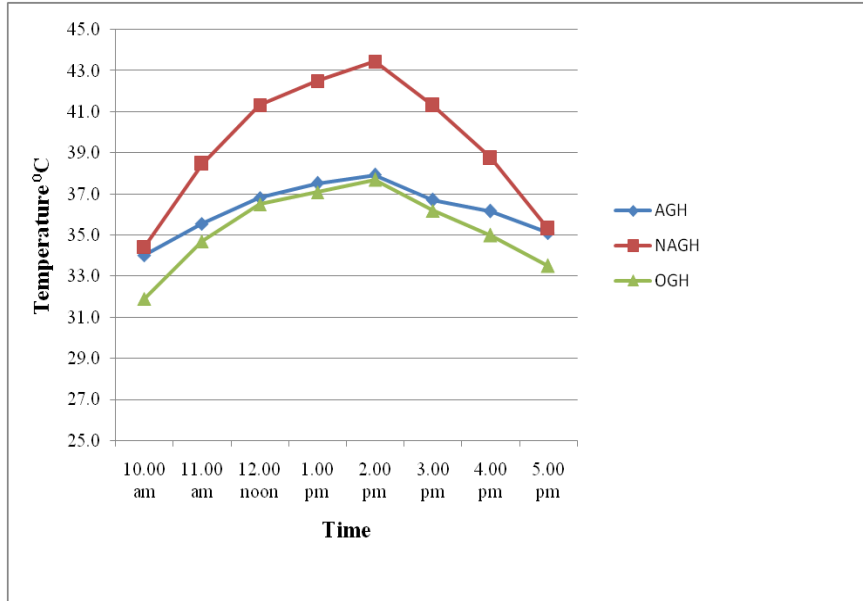

Fig. 4.9 Hourly variation of temperature during February 2016

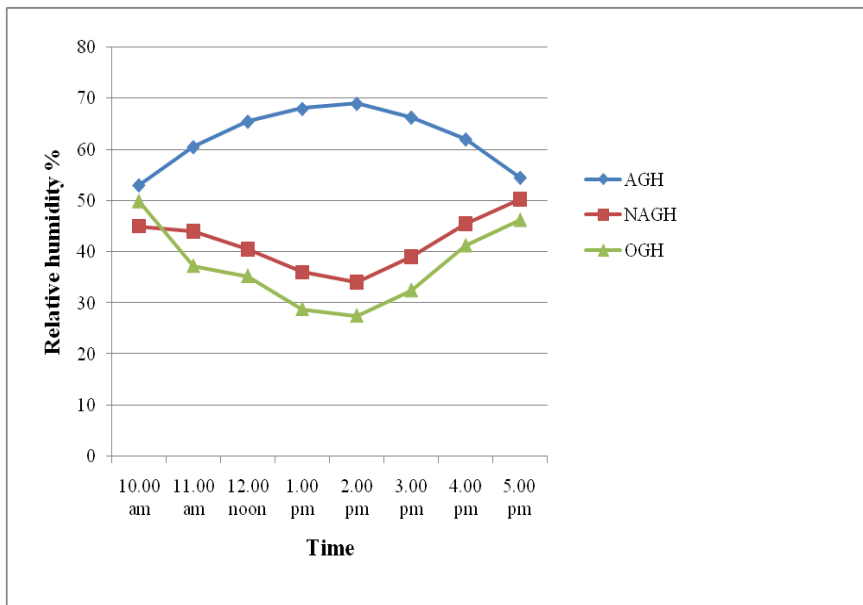

Fig.4.10 Hourly variation of RH during February 2016

Table 4.12 Average temperature during February 2016

Time	Temperature (°C)		
	AGH	NAGH	OGH
10.00 am	34.0	34.4	31.9
11.00 am	35.6	38.5	34.7
12.00 noon	36.8	41.3	36.5
1.00 pm	37.5	42.5	37.1
2.00 pm	37.9	43.5	37.7
3.00 pm	36.7	41.3	36.2
4.00 pm	36.2	38.8	35.0
5.00 pm	35.1	35.3	33.5

Table 4.13 Average RH during February 2016

Time	Relative Humidity (%)		
	AGH	NAGH	OGH
10.00 am	53	45	50
11.00 am	61	44	37
12.00 noon	66	41	35
1.00 pm	68	36	29
2.00 pm	69	34	28
3.00 pm	66	39	33
4.00 pm	62	46	41
5.00 pm	55	50	46

Table 4.14. Mean value of temperature and RH from 10 am to 5 pm during February 2016

	Temperature °C	RH %
AGH	36.2 ^a	62 ^a
NAGH	39.4 ^b	42 ^b
OGH	35.3 ^a	37 ^b

*Values followed by same letters are not significantly different at P<0.05

4.2.2.4 Microclimate Regulation inside the Greenhouse for 4th Month (March 2016) during 1st Crop Season

Microclimate data inside automated greenhouse, non automated greenhouse and outside condition for the month of March 2016 are given in Appendix VI. The variations of temperature from 10 am to 5 pm for different treatments are shown in Fig.4.11 and the corresponding values are given in Table 4.15. The average monthly temperature outside was 34⁰C at 10 am and it gradually increased to 39.3⁰C by 2 pm and thereafter decreased to 34.6⁰C by 5 pm. In the non automated greenhouse, temperature inside the greenhouse was 36.5⁰C at 10 am and it increased up to 45.9⁰C by 2 pm and thereafter decreased gradually to 36.9⁰C by 5 pm. During peak hours the temperature inside the non automated greenhouses was equal or greater than 41⁰C and it was not within the desirable limit for the crop inside it. In automated greenhouse the maximum temperature was 39.7⁰C which was only 0.4⁰C greater than that of outside temperature. Even though the upper temperature limit set in the controller is 37⁰C, during March 2016, between 11am and 3pm, temperature raised above 37⁰C. It may be due to the fact that foggers start functioning only if the RH is below 70 % and the time lag provided between stop and start cycle of foggers was five minutes. The variation of RH from 10 am to 5 pm for automated greenhouse, non automated greenhouse and outside condition are shown in Fig.4.12 and the corresponding values are given in Table 4.16. Outside RH was 48 % at 10 am and reduced to 23 % by 2 pm thereafter increased to 40 % by 5 pm. In the case of non automated greenhouse the corresponding values were 40 %, 31 % and 46 % respectively. But in automated greenhouse, the RH could be maintained between 50 % and 70 % during peak hours. Mean values of temperature and RH from 10 am to 5 pm are given in Table 4.17. One way ANOVA resulted that there was significant difference in temperature between AGH and NAGH but there was no significant difference between AGH and OGH. There was significant difference of temperature between NAGH and OGH. There was significant difference

between relative humidity in AGH and NAGH and also between AGH and OGH. From all these it is clear that automation system worked well for maintaining greenhouse microclimate inside the greenhouse.

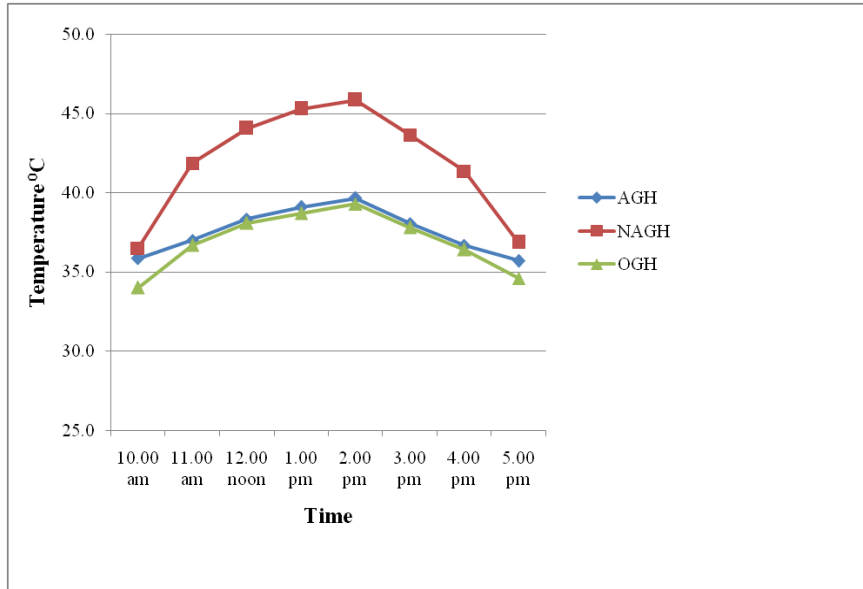

Fig.4.11 Hourly variation of temperature (°C) during March 2016

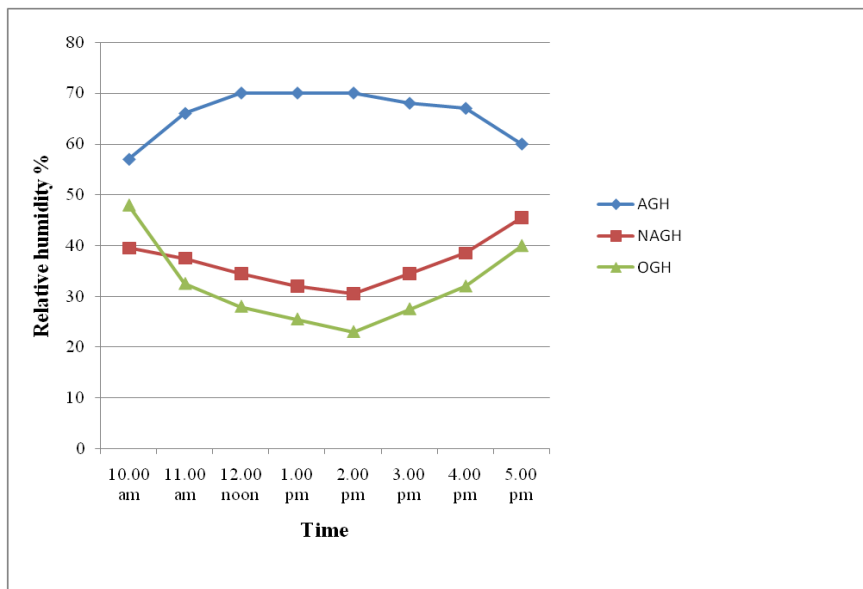

Fig.4.12 Hourly variation of RH (%) during March 2016

Table 4.15 Average temperatures during March 2016

Time	Temperature (⁰ C)		
	AGH	NAGH	OGH
10.00 am	35.9	36.5	34.0
11.00 am	37.0	41.9	36.7
12.00 noon	38.4	44.1	38.1
1.00 pm	39.1	45.3	38.7
2.00 pm	39.7	45.9	39.3
3.00 pm	38.1	43.7	37.8
4.00 pm	36.7	41.4	36.4
5.00 pm	35.7	36.9	34.6

Table 4.16 Average RH during March 2016

Time	Relative Humidity (%)		
	AGH	NAGH	OGH
10.00 am	57	40	48
11.00 am	66	38	33
12.00 noon	70	35	28
1.00 pm	70	32	26
2.00 pm	70	31	23
3.00 pm	68	35	28
4.00 pm	67	39	32
5.00 pm	60	46	40

Table 4.17 Mean value of temperature and RH from 10 am to 5 pm during March 2016

	Temperature ⁰ C	RH %
AGH	37.5 ^a	66 ^a
NAGH	41.9 ^b	37 ^b
OGH	37.0 ^a	32 ^b

*Values followed by same letters are not significantly different at P<0.05

4.2.2.5 Weekly Microclimate Variation for First Crop

Weekly averages of hourly variations of temperatures are shown in Fig. 4.13 to Fig. 4.25. During first week maximum temperature inside the AGH was 36.7⁰C and in NAGH it was 41.9⁰C, whereas the maximum temperature outside was 36.5⁰C. During second week, temperature was less compared to first week. Maximum temperature inside AGH was 36.6⁰C, in NAGH it was 41.2⁰C and it was 36.1⁰C outside the greenhouse. Average temperature during third week was higher than that of second week. Maximum temperatures were 36.9⁰C, 41.9⁰C and 36.7⁰C in AGH, NAGH and OGH, respectively. During 4th, 5th and 6th weeks the temperatures were almost same as that of 3rd week. During 7th week the temperatures were higher. Temperature inside AGH increased up to 37.5⁰C and in NAGH maximum temperature was 42.7⁰C. Outside temperature was also high compared to previous weeks. During 8th week, temperature was slightly less compared to 7th week. Peak temperature was 37.1⁰C in AGH, 42.6⁰C in NAGH and 36.9⁰C outside the greenhouse. Temperature during 9th week was almost same as that of 7th week and during 10th week temperature was higher than that of 9th week. Average maximum temperature inside AGH increased up to 38.2⁰C during 10th week and corresponding temperature was 43.5⁰C and 37.9⁰C for NAGH and OGH, respectively. During 11th, 12th and 13th weeks temperature was very high. In NAGH temperature was above 39⁰C during peak hours (11am to 4pm). Average peak temperature values were 38.9⁰C, 39.2⁰C and 40.1⁰C during 11th, 12th and 13th weeks, respectively. Corresponding values for NAGH were 44.8⁰C, 45.3⁰C and 46.4⁰C, respectively and for OGH values were 38.5⁰C, 38.9⁰C and 39.6⁰C, respectively. During few weeks, temperature inside AGH was higher than that of 37⁰C. This was because the time lag provided between stop and start cycle of foggers was five minutes and foggers, if stopped, will restart only after five minutes or if the relative humidity is greater than 70 %. During peak hours, temperature inside AGH was nearer to that of temperature outside the greenhouse. Temperature inside the non automated greenhouse was very high compared to that

of automated greenhouse. This shows that automatic microclimate control is better than manual management of greenhouse microclimate.

Weekly averages of hourly variations of relative humidity during first crop season are given in Fig. 4.26 to Fig. 4.38. Relative humidity was within the optimum range during all the weeks inside the automated greenhouse and was between 50 % to 70 % during the peak time (10 am to 5 pm). In NAGH and OGH, relative humidity was very less during peak hours. During first week, RH inside NAGH reduced from 52 % at 10 am to 35 % at 2 pm, thereafter increased to 51 % by 5 pm. Relative humidity was less than 50 % in NAGH in between 10 am and 5 pm. Relative humidity outside the greenhouse was also less than 50 % during peak hours. RH outside the greenhouse was 57 % at 10 am and it reduced to 30 % by 2 pm, thereafter increased to 45 % by 5 pm. During second week, relative humidity was within 55 % to 65 % in AGH and in NAGH it was between 34 % and 51 % during peak hours. RH outside the greenhouse was 30 % to 56 % between 10 am to 5 pm. During 3rd week, because of the functioning of the automation system, the RH in AGH was between 56 % and 69 %. In NAGH relative humidity was 49 % at 10 am and it reduced to 34 % by 2 pm, thereafter increased to 49 %. RH outside the greenhouse was 52 % at 10 am and it reduced to 29 % by 2 pm, thereafter increased to 40 % by 5 pm. In between 11 am and 4 pm, the RH was less than 40 % in NAGH and OGH. Weekly average values of minimum relative humidity values in NAGH were 37 %, 35 %, 35 %, 30 %, 35 %, 34 %, 35 %, 32 %, 31 % and 30 % during 4th, 5th, 6th, 7th, 8th, 9th, 10th, 11th, 12th and 13th week, respectively and the corresponding values in OGH were 30 %, 28 %, 28 %, 29 %, 29 %, 28 %, 28 %, 25 %, 24 % and 22 % respectively. Relative humidity was below 30 % outside the greenhouse between 11 am and 4 pm during final weeks. Lowest relative humidity values were noted outside the greenhouse compared to AGH and NAGH during all the weeks. In AGH, because of the timely operation of foggers to reduce temperature inside the greenhouse, the relative humidity values were above 60 % during peak hours of the day. But it

never increased above 70 % because it is the maximum value of RH set in the controller. Automation system reduced the temperature inside the greenhouse while at the same time, the RH inside the greenhouse never increased beyond 70 %. This shows that automatic microclimate control is better than manual microclimate control in greenhouses.

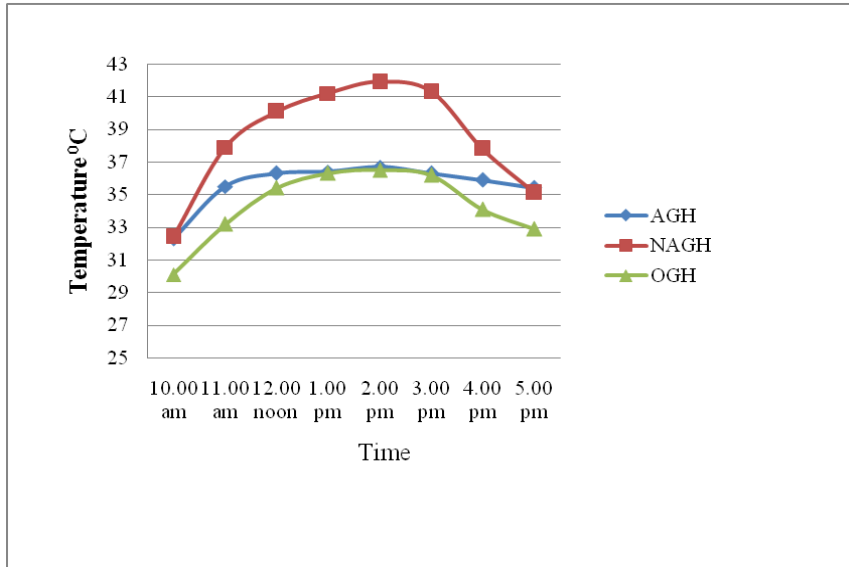

Fig.4.13 Hourly variation of temperature (°C) during first week (1st crop)

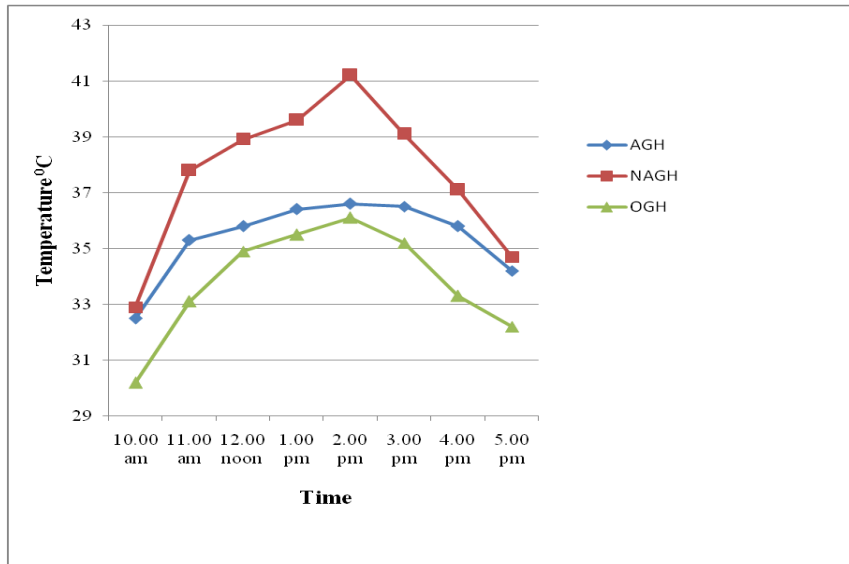

Fig.4.14 Hourly variation of temperature (°C) during second week (1st crop)

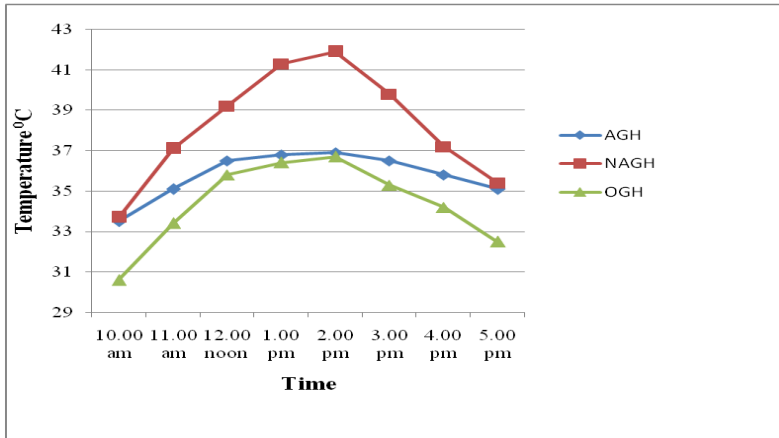

Fig.4.15 Hourly variation of temperature ($^{\circ}$ C) during third week (1st crop)

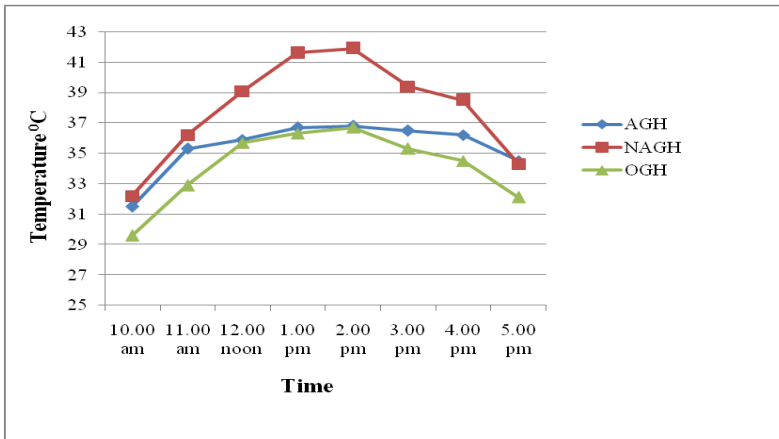

Fig.4.16 Hourly variation of temperature ($^{\circ}$ C) during fourth week (1st crop)

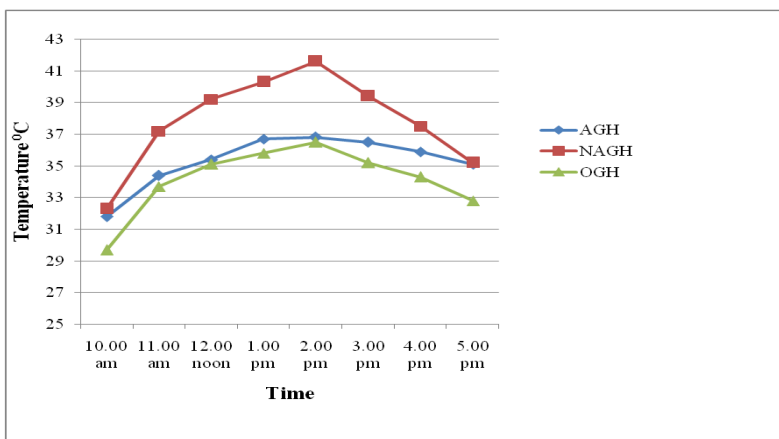

Fig.4.17 Hourly variation of temperature ($^{\circ}$ C) during fifth week (1st crop)

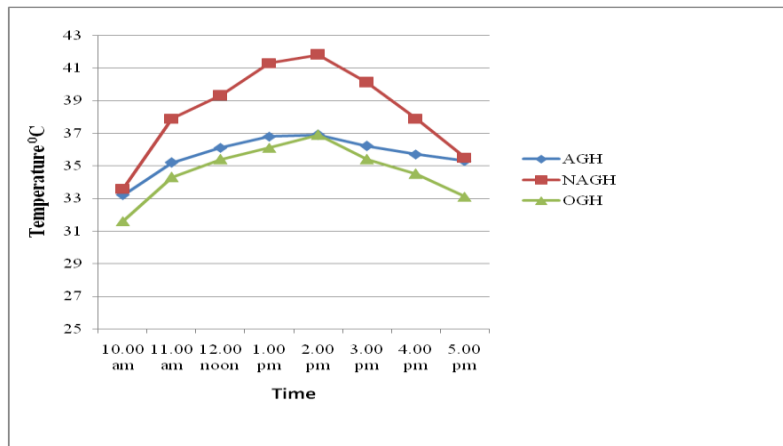

Fig.4.18 Hourly variation of temperature ($^{\circ}$ C) during sixth week (1st crop)

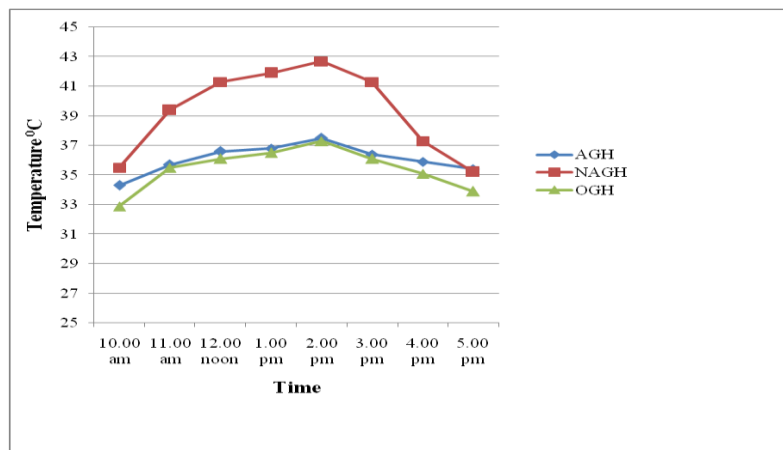

Fig.4.19 Hourly variation of temperature ($^{\circ}$ C) during seventh week (1st crop)

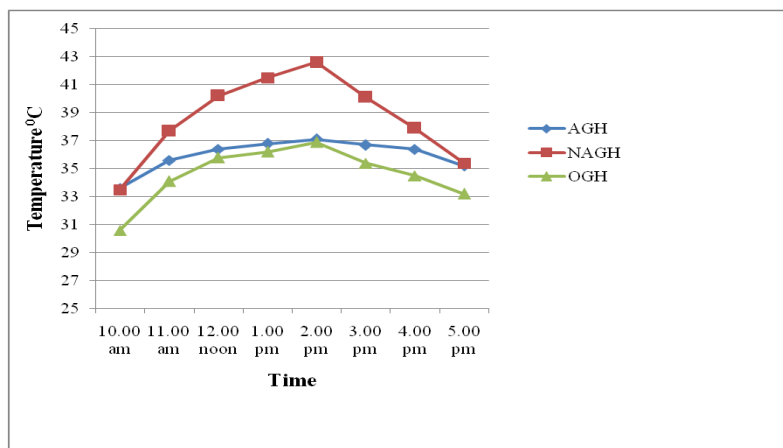

Fig.4.20 Hourly variation of temperature ($^{\circ}$ C) during eighth week (1st crop)

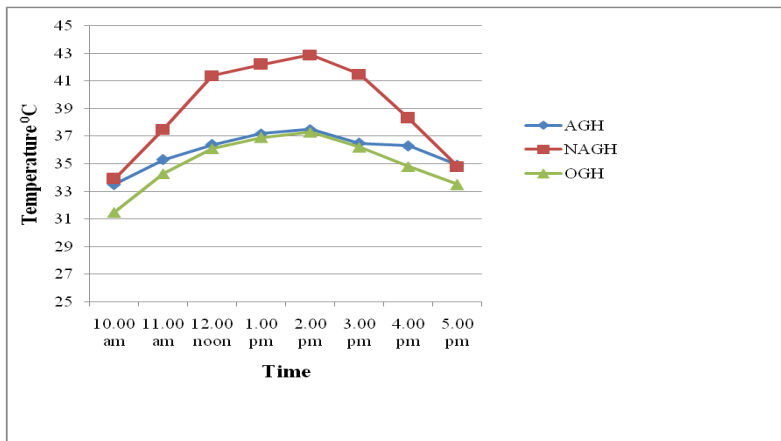

Fig.4.21 Hourly variation of temperature ($^{\circ}$ C) during ninth week (1st crop)

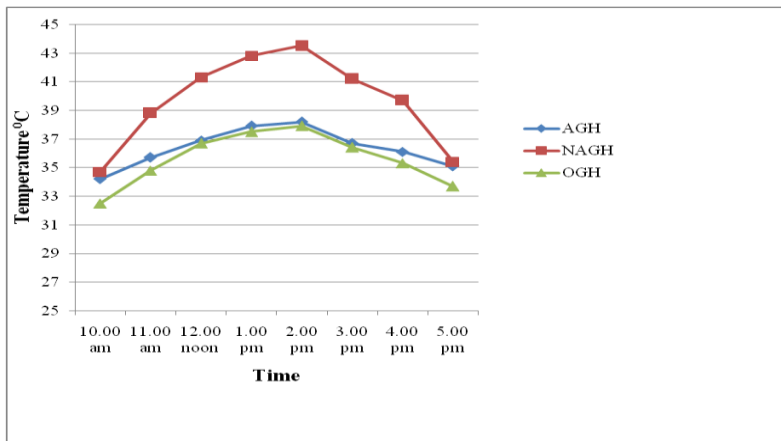

Fig.4.22 Hourly variation of temperature ($^{\circ}$ C) during tenth week (1st crop)

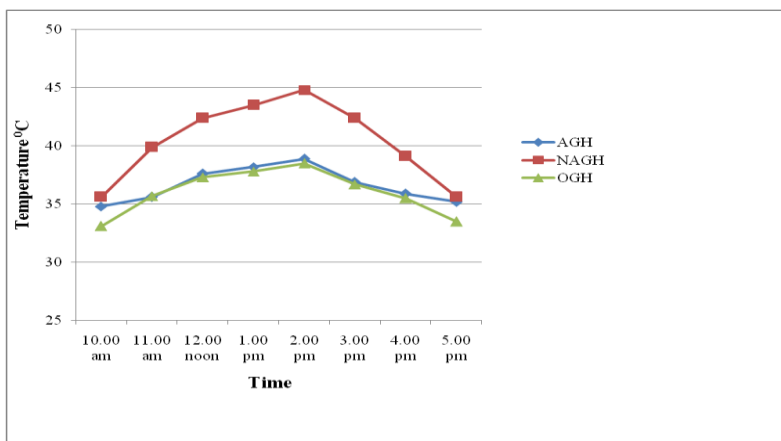

Fig.4.23 Hourly variation of temperature ($^{\circ}$ C) during eleventh week (1st crop)

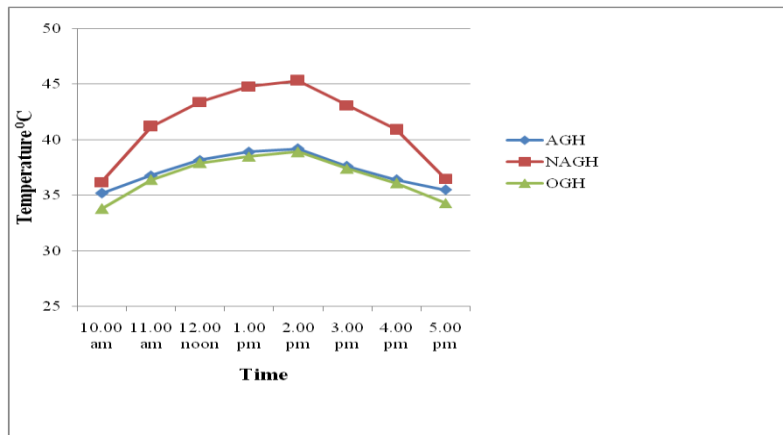

Fig.4.24 Hourly variation of temperature ($^{\circ}$ C) during twelfth week (1st crop)

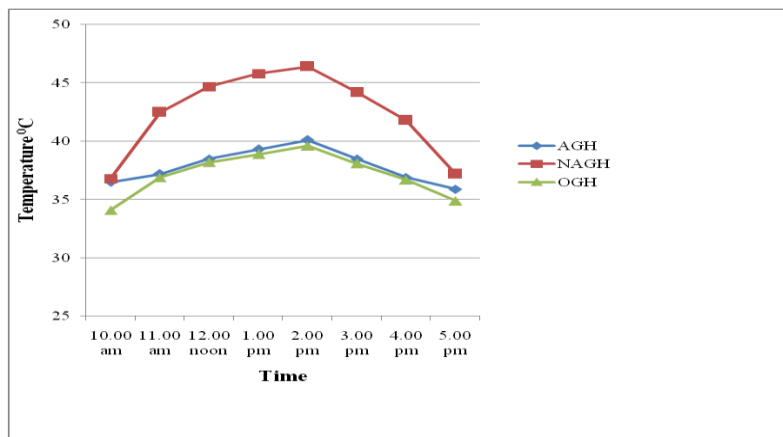

Fig.4.25 Hourly variation of temperature ($^{\circ}$ C) during thirteenth week (1st crop)

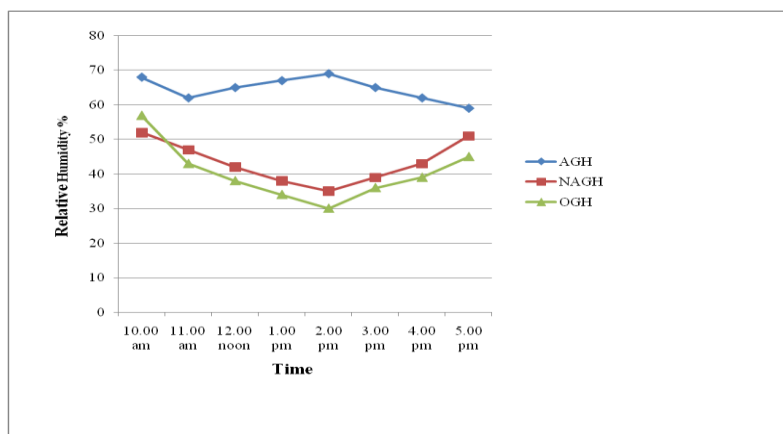

Fig.4.26 Hourly variation of RH during first week (1st crop)

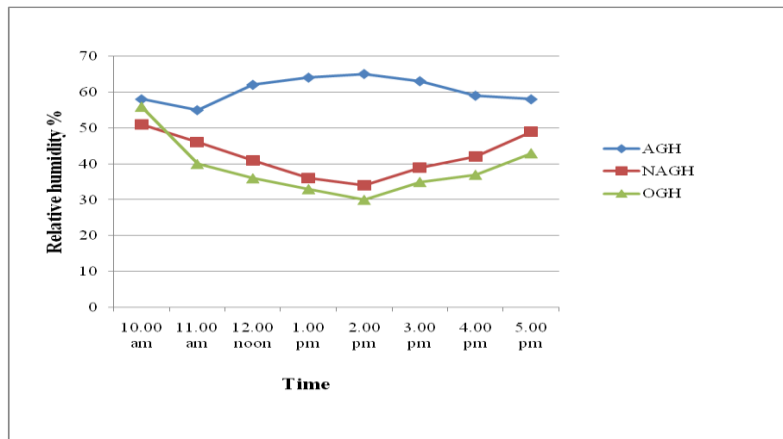

Fig.4.27 Hourly variation of RH during second week (1st crop)

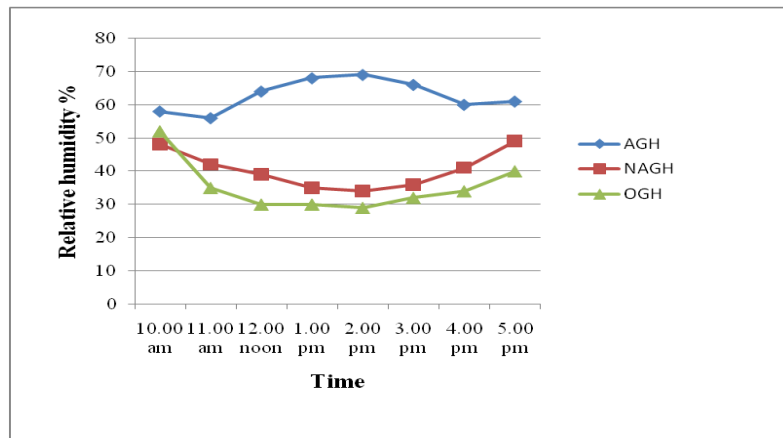

Fig.4.28 Hourly variation of RH during third week (1st crop)

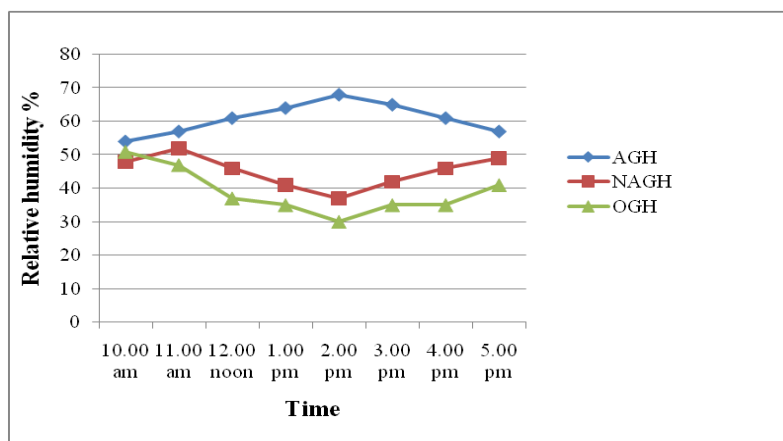

Fig.4.29 Hourly variation of RH during fourth week (1st crop)

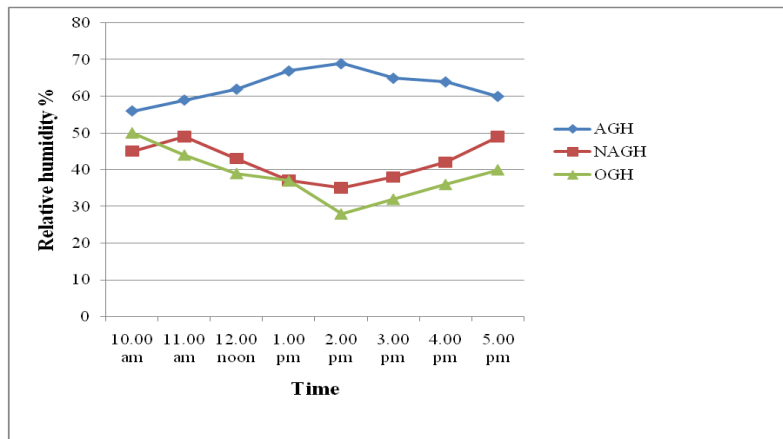

Fig.4.30 Hourly variation of RH during fifth week (1st crop)

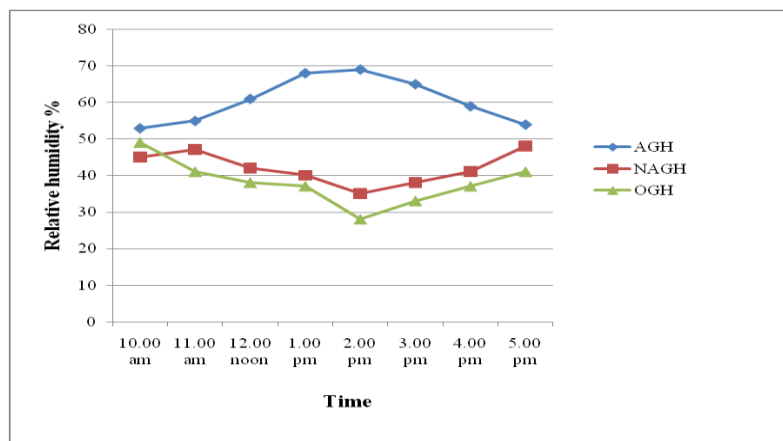

Fig.4.31 Hourly variation of RH during sixth week (1st crop)

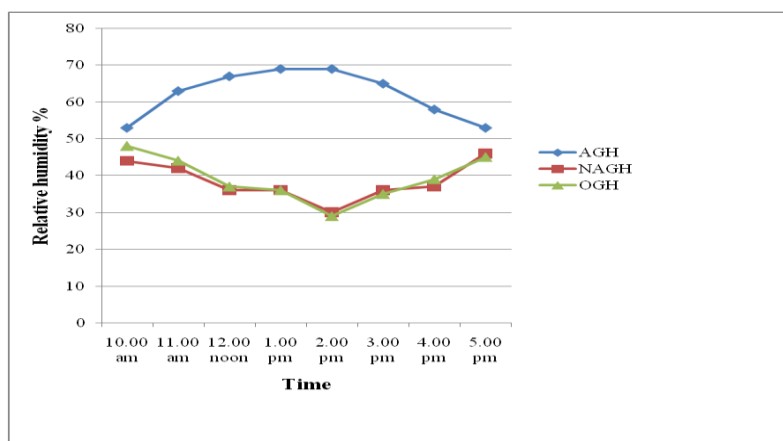

Fig.4.32 Hourly variation of RH during seventh week (1st crop)

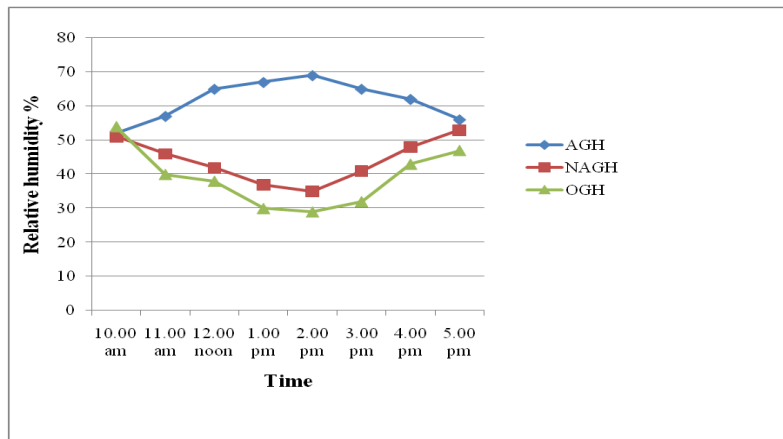

Fig.4.33 Hourly variation of RH during eighth week (1st crop)

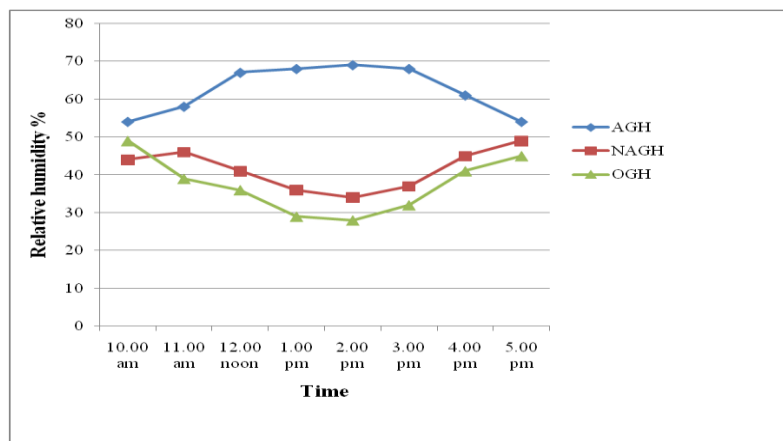

Fig.4.34 Hourly variation of RH during ninth week (1st crop)

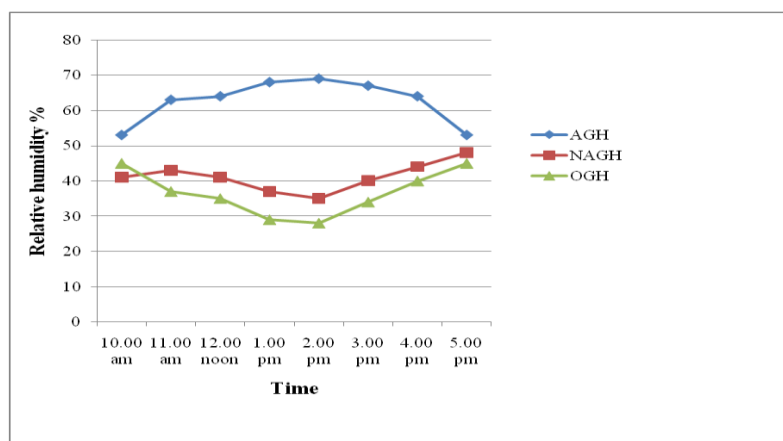

Fig.4.35 Hourly variation of RH during tenth week (1st crop)

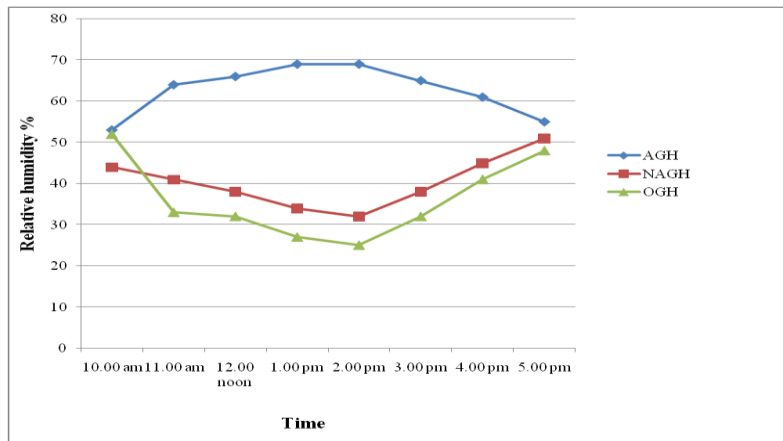

Fig.4.36 Hourly variation of RH during eleventh week (1st crop)

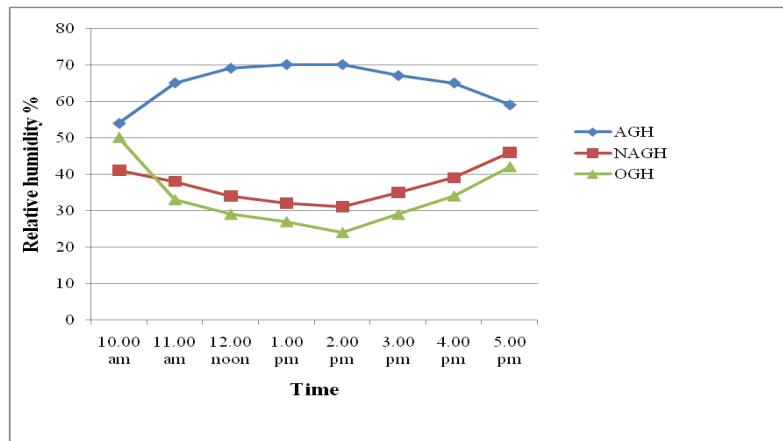

Fig.4.37 Hourly variation of RH during twelfth week (1st crop)

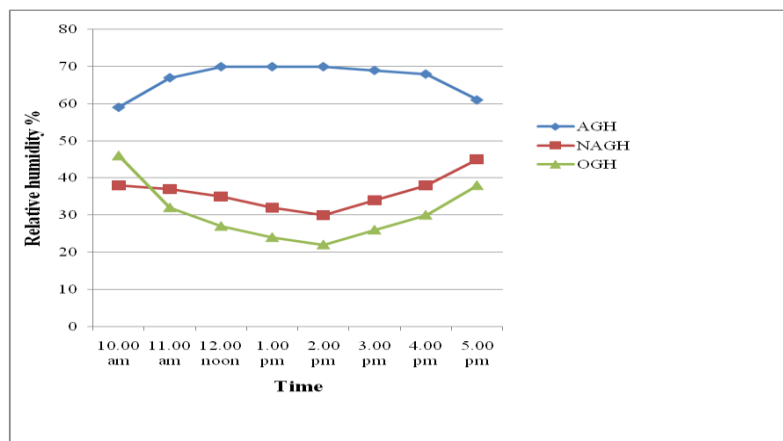

Fig.4.38 Hourly variation of RH during thirteenth week (1st crop)

4.2.3 Microclimate Regulation for the Second Crop Season

The hourly average values microclimate data for second crop season is given in Appendix VII. The seasonal average value of temperatures in automated greenhouse, non automated greenhouse and outside condition from 10 am to 5 pm is shown graphically in Fig.4.39 and the values are given in Table 4.18. Maximum temperature inside the non automated greenhouse was 39.2⁰C, while in automated greenhouse, it was 36.9⁰C. Compared to first season the temperature values were low in both automated and non automated greenhouse as second crop cultivation was done during the months of May 2016, June 2016 and July 2016 and during this period because of heavy rainfall, outside temperature was lower. Outside temperature varies from 29.6⁰C at 10 am and increased to 34.7⁰C by 2 pm thereafter decreased to 29.1⁰C by 5 pm. In non automated greenhouse corresponding values were 32.3⁰C, 39.2⁰C and 31.4⁰C and in automated greenhouse corresponding values were 31.7⁰C, 36.9⁰C and 31.1⁰C, respectively. The hourly average variations of RH for second crop season from 10 am to 5 pm are shown graphically in Fig.4.40 and corresponding values are given in Table 4.19. Outside relative humidity was 67 % at 10 am and it reduced to 48 % by 2 pm, and thereafter increased to 72% by 5 pm. In non automated greenhouse the RH values were 68 %, 47 % and 71 % at 10 am, 2 pm and 5 pm, respectively. It was almost same as that of outside condition. In automated greenhouse, at 10 am RH was 71 % and 74 % at 5 pm. In between 10 am and 5 pm the RH was 59 % to 66 %. Compared to first season, during second season the RH was higher because of the rainfall and temperature inside the AGH was lesser than 37⁰C and hence automation system did not work on most of the days during second crop season. The cooling system was not switched on in NAGH also because of the lower temperature during rainy days. That is why there was not much difference between the temperature and RH values for AGH and NAGH. Mean values of temperature and relative humidity during second crop season are given in Table 4.20. One way ANOVA test conducted and resulted that there was no significant

difference between temperature in AGH and NAGH but there was significant difference between mean temperature in AGH and OGH. There was significant difference of between relative humidity in AGH and NAGH and AGH and OGH but there was no significant difference between RH in NAGH and OGH. The reason for this was out of the thirteen weeks, the cooling system worked only during initial five weeks. During remaining period there was no need of operation of any cooling system in both the greenhouses. Hence there was no significant difference between temperature in AGH and NAGH. There was significant difference in RH between AGH and NAGH because during the initial five weeks the difference in RH was high in both the greenhouses. This result is an indication that it was because of the timely management of automation system, the temperature inside the AGH was lower in AGH compared to NAGH.

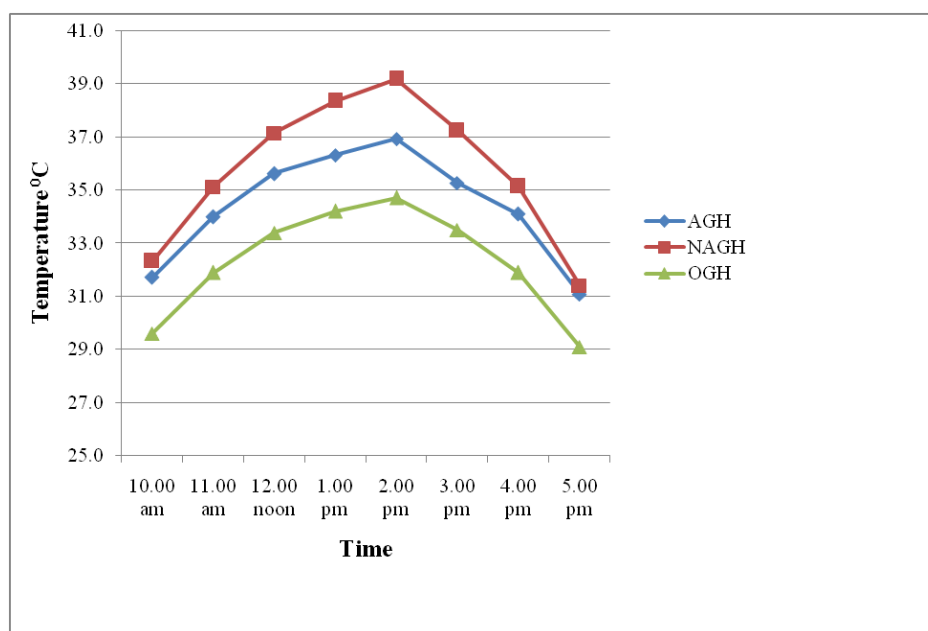

Fig. 4.39 Hourly variation of temperature ($^{\circ}\text{C}$) during second crop season

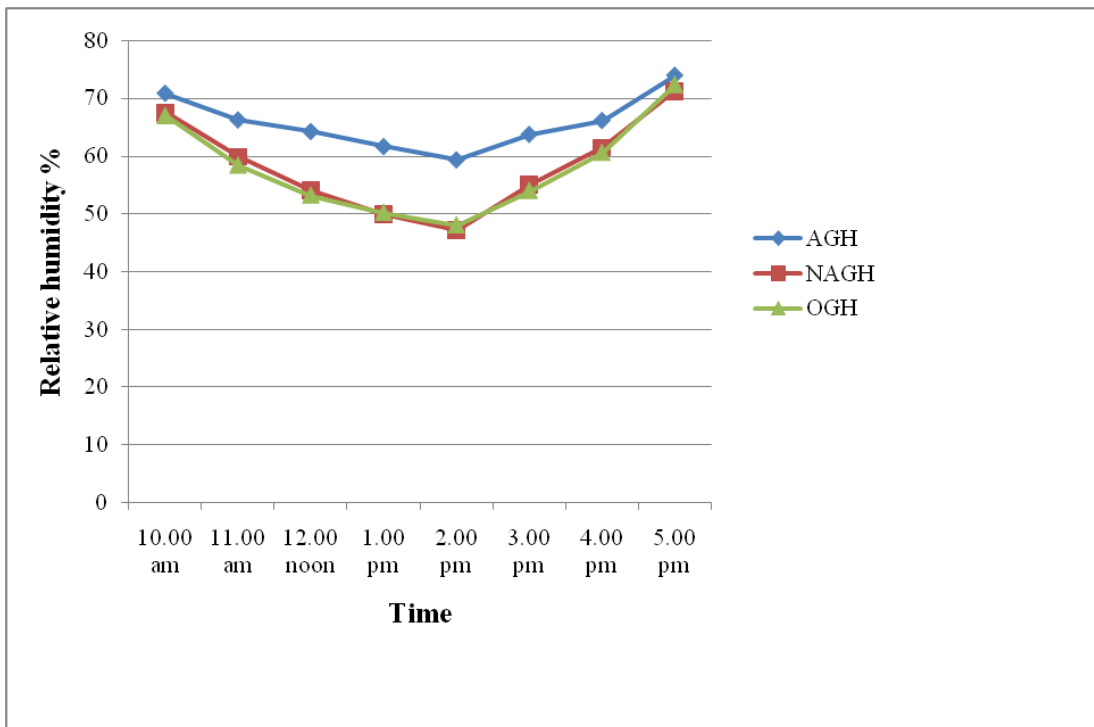

Fig. 4.40 Hourly variation of RH (%) during second crop season

Table 4.18 Average temperature during second crop season

Time	Temperature °C		
	AGH	NAGH	OGH
10.00 am	31.7	32.3	29.6
11.00 am	34.0	35.1	31.9
12.00 noon	35.6	37.1	33.4
1.00 pm	36.3	38.3	34.2
2.00 pm	36.9	39.2	34.7
3.00 pm	35.3	37.2	33.5
4.00 pm	34.1	35.1	31.9
5.00 pm	31.1	31.4	29.1

Table 4.19 Average RH during second crop season

Time	Relative Humidity %		
	AGH	NAGH	OGH
10.00 am	71	68	67
11.00 am	66	60	58
12.00 noon	64	54	53
1.00 pm	62	50	50
2.00 pm	59	47	48
3.00 pm	64	55	54
4.00 pm	66	62	61
5.00 pm	74	71	72

Table 4.20 Mean value of temperature and RH from 10 am to 5 pm during second crop season

	Temperature °C	RH %
AGH	34.4 ^a	66 ^a
NAGH	35.7 ^a	58 ^b
OGH	32.3 ^b	58 ^b

*Values followed by same letters are not significantly different at P<0.05

4.2.3.1 Microclimate Regulation inside the Greenhouse for 1st Month (May 2016) during 2nd Crop Season.

Average hourly microclimatic data of first month of second crop season (May 2016) for AGH, NAGH and outside condition from 10 am to 5 pm are given in Appendix VIII. The average hourly variations of temperature from 10 am to 5 pm are shown Fig.4.41 and corresponding values are given in Table 4.21. Outside temperature was 32.5⁰C at 10 am and it increased up to 38.1⁰C by 2 pm, which decreased to 32.3⁰C by 5 pm. In NAGH the temperature was 36⁰C at 10 am and it increased to 44.3⁰C by 2 pm, thereafter decreased to 35⁰C by 5 pm. During peak hours, the temperature inside the NAGH was above 38⁰C and it increased up to 44.3⁰C. This range of temperature was not good for the cucumber crop cultivated

inside the greenhouse. While in AGH maximum temperature noted was 38.6⁰C at 2 pm. In between 12noon and 3 pm temperature was above 37⁰C in AGH because the foggers operate only if the RH is less than 70 % and there was a 5 minute time lag between stop and start cycles of the fogger operation. This slight increase is due to the fact that the working of foggers is required to reduce the higher temperature and the automation system is programmed in such a way that the foggers operate only when the RH is less than 70 %. This was the reason for the slight increase of temperature than the maximum set point. The hourly variation of RH for May 2016 inside AGH, NAGH and outside GH are shown in Fig. 4.42 and the corresponding values are given in Table 4.22. Average outside RH for the first month of second crop was 44 % at 10 am and it decreased to 26 % by 2 pm, thereafter increased to 50 % by 5 pm. Inside the NAGH the RH values 56 % at 10 am and it reduced to 38 % by 2 pm and then increased to 62 % by 5 pm. In AGH the RH was less than or equal to 70 %. The RH values inside AGH were nearer to 65 % as foggers were operated several times to reduce the temperature and hence the RH values were in between 65 and 70 %. Mean values of temperature and RH from 10 am to 5 pm are given in Table 4.23. One way ANOVA resulted that there was significant difference in temperature between AGH and NAGH but there was no significant difference between AGH and OGH. There was significant difference of temperature between NAGH and OGH. There was significant difference between relative humidity in AGH and NAGH and also between AGH and OGH. This was because of the better temperature management by the automation system in AGH. Because of the operation of foggers the RH inside the AGH was also high compared to NAGH.

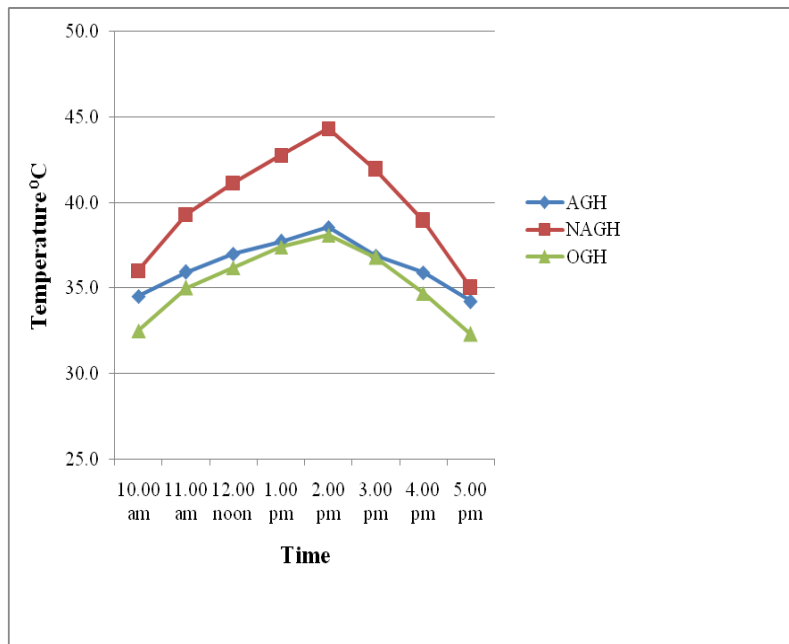

Fig.4.41 Hourly variation of temperature (°C) during May 2016

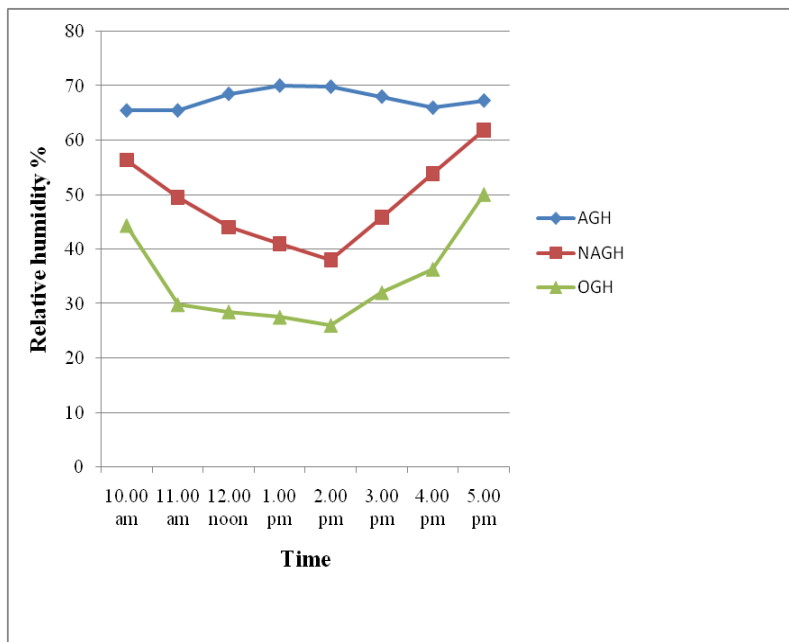

Fig.4.42 Hourly variation of RH (%) during May 2016

Table 4.21 Average temperature during May 2016

Time	Temperature °C		
	AGH	NAGH	OGH
10.00 am	34.5	36.0	32.5
11.00 am	36.0	39.3	35.0
12.00 noon	37.0	41.2	36.2
1.00 pm	37.7	42.8	37.4
2.00 pm	38.6	44.3	38.1
3.00 pm	36.9	41.9	36.8
4.00 pm	35.9	38.9	34.7
5.00 pm	34.2	35.0	32.3

Table 4.22 Average RH during May 2016

Time	Relative Humidity %		
	AGH	NAGH	OGH
10.00 am	66	56	44
11.00 am	66	50	30
12.00 noon	69	44	29
1.00 pm	70	41	28
2.00 pm	70	38	26
3.00 pm	68	46	32
4.00 pm	66	54	36
5.00 pm	67	62	50

Table 4.23 Mean temperature and RH from 10 am to 5 pm during May2016

	Temperature °C	RH %
AGH	36.3 ^a	68 ^a
NAGH	39.9 ^b	49 ^b
OGH	35.4 ^a	34 ^c

*Values followed by same letters are not significantly different at P<0.05

4.2.3.2 Microclimate Regulation inside the Greenhouse for 2nd Month (June 2016) during 2nd Crop Season

Average microclimate data for the second month of second crop (June 2016), for AGH, NAGH and outside condition are given in Appendix IX. Variation of average temperatures from 10am to 5 pm for AGH, NAGH and outside is shown in Fig.4.43 and the corresponding values are given in Table 4.24. The curves for the AGH and NAGH are almost closer because most of the values of temperatures are almost same. Compared to average temperatures of previous month, temperatures were lower for this month because of rainfall and the maximum average outside temperature was 33⁰C. In NAGH, the temperature was 30.2⁰C at 10am and it increased to 36.9⁰C by 2 pm, thereafter decreased to 28.9⁰C by 5 pm. In AGH the corresponding temperature values were 30.1⁰C, 35.9⁰C and 28.7⁰C respectively. There was no much difference in the temperature between AGH and NAGH, because rainfall reduced the temperature and cooling system was not needed for most of the days. So the microclimate inside both AGH and NAGH were almost same. The variation of average RH during June 2016 in AGH, NAGH and at outside are shown graphically in Fig.4.44 and the corresponding values are given in Table 4.25. The outside minimum RH was 59% and most of the time it was above 65 %. RH was almost same in AGH and NAGH and it was slightly higher at AGH. The reason was that during initial days, the cooling system worked well inside the AGH compared to NAGH and hence during that time RH was higher in AGH compared to NAGH. Mean values of temperature and relative humidity are given in Table 4.26. There was no significant difference between mean temperature in AGH and NAGH but there was significant difference of mean temperature between NAGH and OGH. There was no significant difference of relative humidity between AGH and NAGH and also between AGH and OGH. This was because during June 2016 the cooling system was operated only for one week and remaining part of the month microclimate was same in both the greenhouses.

Table 4.24 Average temperature during June 2016

Time	Temperature °C		
	AGH	NAGH	OGH
10.00 am	30.1	30.2	27.9
11.00 am	33.1	33.2	30.4
12.00 noon	34.5	34.9	31.8
1.00 pm	35.4	36.5	32.7
2.00 pm	35.9	36.9	33.0
3.00 pm	34.3	35.0	31.7
4.00 pm	32.6	32.8	30.0
5.00 pm	28.7	28.9	26.9

Table 4.25 Average RH during June 2016

Time	Relative Humidity %		
	AGH	NAGH	OGH
10.00 am	72	72	78
11.00 am	66	64	72
12.00 noon	63	59	65
1.00 pm	59	54	60
2.00 pm	57	52	59
3.00 pm	62	60	65
4.00 pm	67	67	74
5.00 pm	79	78	88

Table 4.26 Mean temperature and RH from 10 am to 5 pm during June 2016

	Temperature °C	RH %
AGH	33.1 ^a	66 ^a
NAGH	33.5 ^a	63 ^a
OGH	30.6 ^b	70 ^a

*Values followed by same letters are not significantly different at P<0.05

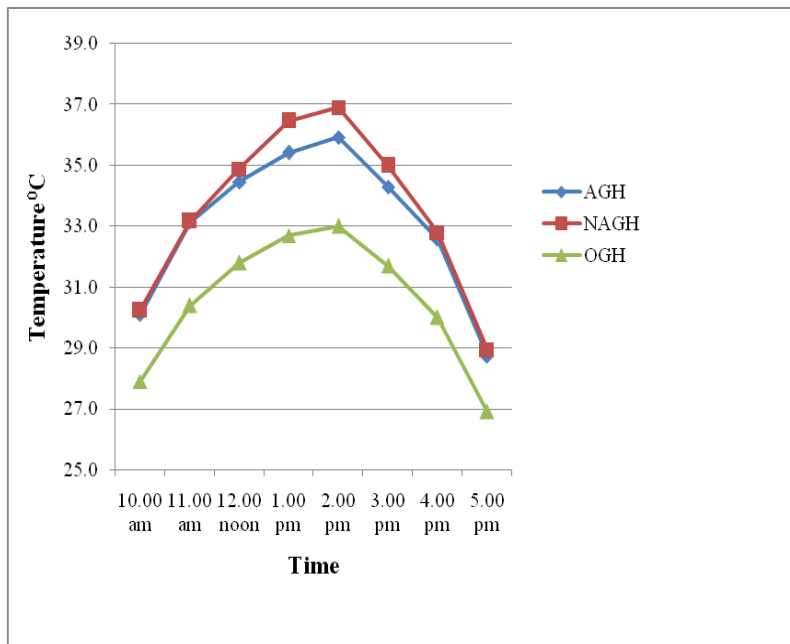

Fig.4.43 Hourly variation of average temperature (°C) during June 2016

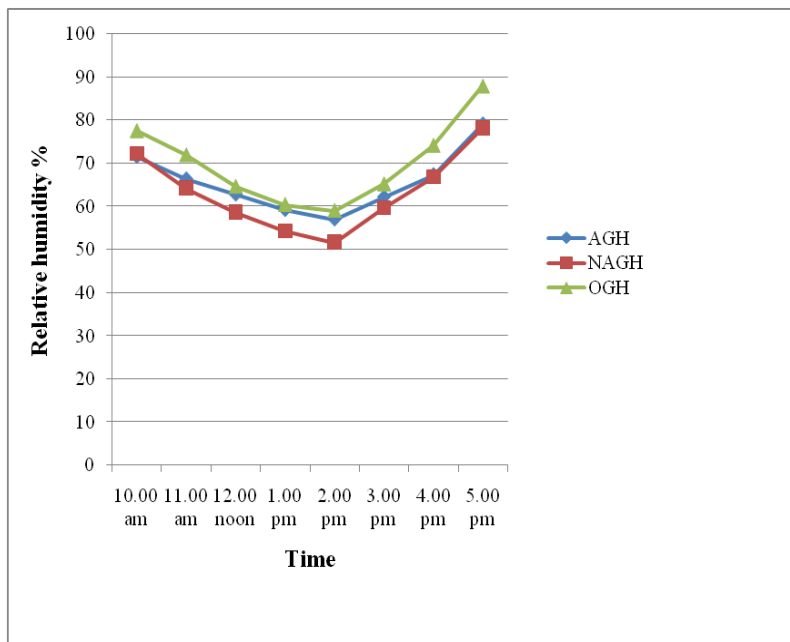

Fig.4.44 hourly variation of average RH (%) during June 2016

4.2.3.3 Microclimate Regulation inside the Greenhouse for 3rd Month (July 2016) during 2nd Crop Season

The average values microclimate data for 3rd month after transplanting during second crop season for AGH, NAGH and outside are given in Appendix X. Intensity of solar radiation was very less during this month. Average value of maximum solar intensity was 38453 lux for outside condition and inside AGH it was 21518 lux and inside NAGH it was 21977 lux. Since the radiation coming inside the greenhouse was very less, the temperature inside the greenhouse was low and there was no need of any cooling system inside both AGH and NAGH. Hence the values of temperatures and RH in both the greenhouses were almost same. The variation of temperature from 10 am to 5pm inside AGH, NAGH and outside for third month after transplanting; that is July 2016 are shown in Fig.4.45 and the corresponding values are given in Table 4.27. Maximum outside temperature was 32.9⁰C and it varied from 28.4⁰C at 10 am and increased to 32.9⁰C, thereafter decreased to 28⁰C by 5pm. In AGH the temperature was 30.5⁰C at 10am and it increased to 36.3⁰C by 2 pm, thereafter decreased to 30.3⁰C by 5 pm. In NAGH the corresponding values were 30.7⁰C, 36.3⁰C and 30.3⁰C at 10 am, 2 pm and 5 pm, respectively. Temperatures inside both AGH and NAGH were below 37⁰C and hence cooling system did not operate in AGH automatically and in NAGH the foggers were not switched on manually. Hence the temperatures of both the greenhouses were almost same. The temperatures inside both the greenhouses were same. The average RH variations from 10 am to 5 pm are shown in Fig.4.46 and the corresponding values are given in Table 4.28. The RH curves for AGH and NAGH are almost overlaying because the values are almost same for both the cases. RH varied from 79% at 10am and decreased to 59% by 2 pm, and thereafter increased to 79 % by 5pm. In both the greenhouses RH were almost same and minimum RH values were 52 % because of the non operation of any cooling system in the greenhouses. . Mean values of temperature and relative humidity are given in Table 4.29. There was no

significant difference between mean temperature in AGH and NAGH but there was significant difference between temperature in AGH and OGH. Also there was significant difference of mean temperature between NAGH and OGH. There was no significant difference of relative humidity between AGH and NAGH and also between AGH and OGH. This was because during July 2016 the cooling system was not operated in both the greenhouses. This proved that the lower temperature in AGH than NAGH was because of the better microclimate management of automation system.

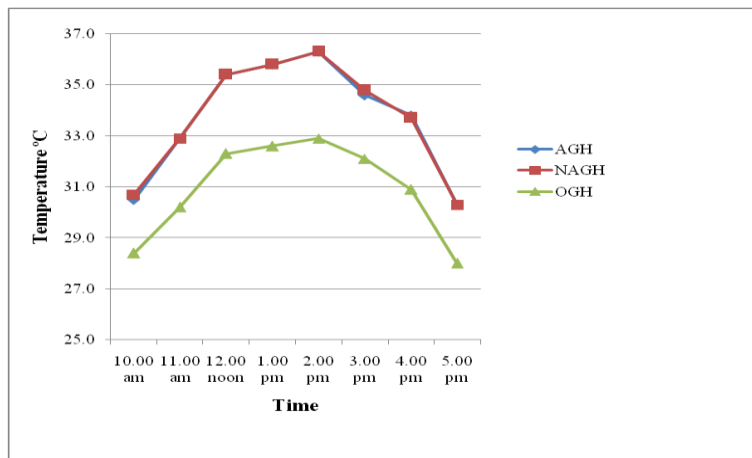

Fig.4.45 Hourly variation of temperature (°C) during July 2016

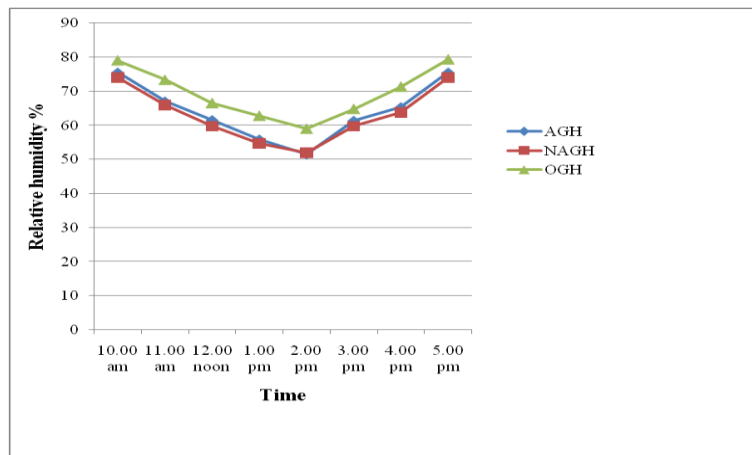

Fig. 4.46 Hourly variation of RH (%) during July 2016

Table 4.27 Average temperature during July 2016

Time	Temperature °C		
	AGH	NAGH	OGH
10.00 am	30.5	30.7	28.4
11.00 am	32.9	32.9	30.2
12.00 noon	35.4	35.4	32.3
1.00 pm	35.8	35.8	32.6
2.00 pm	36.3	36.3	32.9
3.00 pm	34.6	34.8	32.1
4.00 pm	33.8	33.7	30.9
5.00 pm	30.3	30.3	28.0

Table 4.28 Average RH during July 2016

Time	Relative Humidity %		
	AGH	NAGH	OGH
10.00 am	76	74	79
11.00 am	67	66	73
12.00 noon	62	60	67
1.00 pm	56	55	63
2.00 pm	52	52	59
3.00 pm	61	60	65
4.00 pm	65	64	71
5.00 pm	76	74	79

Table 4.29 Mean temperature and RH from 10 am to 5 pm during July 2016

	Temperature °C	RH %
AGH	33.7 ^a	64 ^a
NAGH	33.7 ^a	63 ^a
OGH	30.9 ^b	70 ^a

*Values followed by same letters are not significantly different at P<0.05

4.2.3.4 Weekly Microclimate Variation during Second Crop

Weekly averages of hourly variations of temperatures during 2nd crop season are given in Fig.4.47 to Fig.4.59. During initial five weeks temperature was very high and during remaining weeks, because of rainfall, outside temperatures were within the desirable limit of crops without the operation of any cooling device inside the greenhouse. Temperature inside the AGH during first week increased up to 40.2⁰C and in NAGH it increased up to 45.7⁰C. Corresponding temperature outside the greenhouse was 39.5⁰C and because of the higher outside temperature, greenhouse temperature was also very high. In NAGH, temperature was above 38⁰C during peak hours. Temperature inside AGH was lesser by 5⁰C than NAGH during peak hours, but because of the very high ambient temperature, greenhouse temperature was very high and hence in AGH temperature increased above the set point of 37⁰C. This was because of the time lag set in the controller between stop and start cycles of fogger. It was also due to higher humidity as the foggers gets switched off when RH becomes 70 % and it will operate only when the RH reduces less than or equal to 65 %. Temperatures during second week after transplanting were slightly less compared to first week, even then, the temperature inside AGH increased above set point because higher solar intensity level. In AGH, weekly average temperature during peak time was 38.5⁰C and in NAGH it was 44.8⁰C. In NAGH temperature was 6⁰C higher than that of AGH. This shows the advantage of automation system than the manual control of cooling system in greenhouses. Temperature during third week was almost similar to that of second week. During fourth week, temperature was less compared to previous weeks. In AGH temperature was higher only during noon, but in NAGH temperature was above 37⁰C between 11am and 4 pm. During 5th week, temperature was similar to that of fourth week. During evening light intensity was less because of clouds and rain and hence temperature was also low. From 6th week to 13th week, due to the rainfall, outside temperature was low and hence greenhouse temperature also was within the

desirable limit of crop without any artificial cooling. Hence automatic cooling system did not operate inside the AGH and in NAGH it was not operated manually. The temperature during these weeks in AGH and NAGH were almost same. From these results it can be concluded that automation system is well suited to manage greenhouse microclimate.

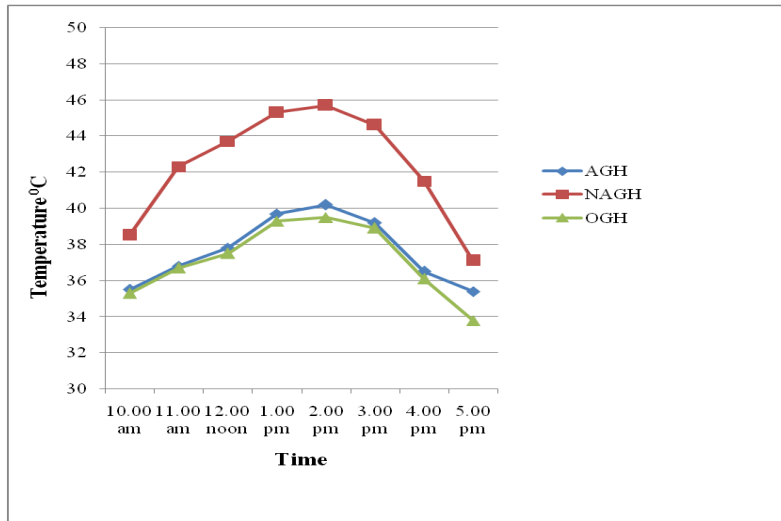

Fig.4.47 Hourly variation of temperature (°C) during first week (2nd crop)

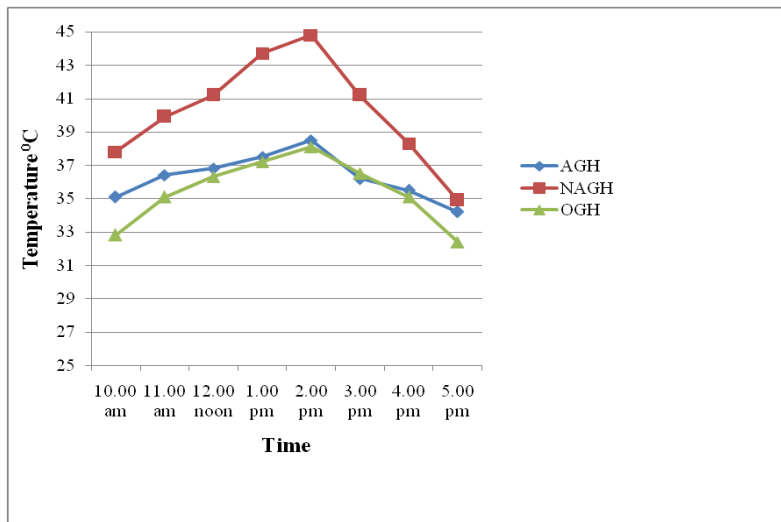

Fig.4.48 Hourly variation of temperature (°C) during second week (2nd crop)

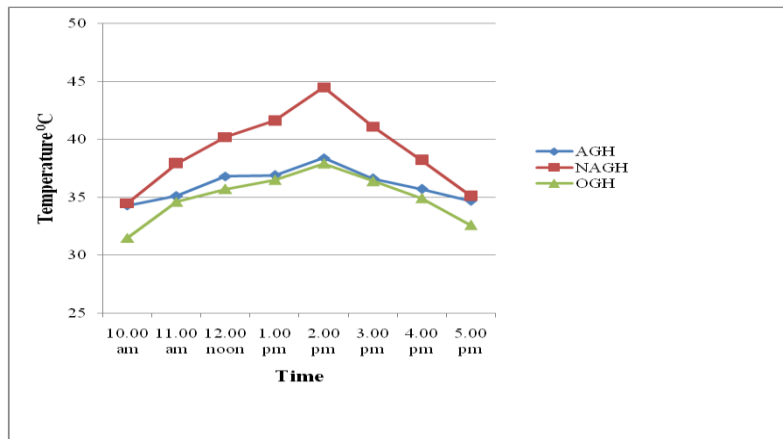

Fig.4.49 Hourly variation of temperature (°C) during third week (2nd crop)

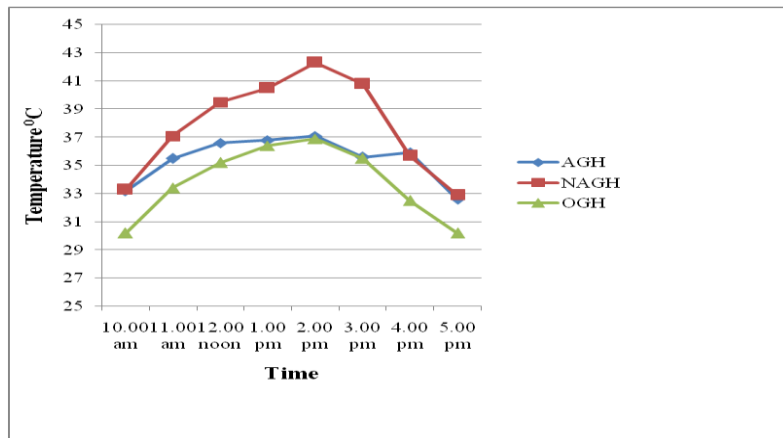

Fig.4.50 Hourly variation of temperature (°C) during fourth week (2nd crop)

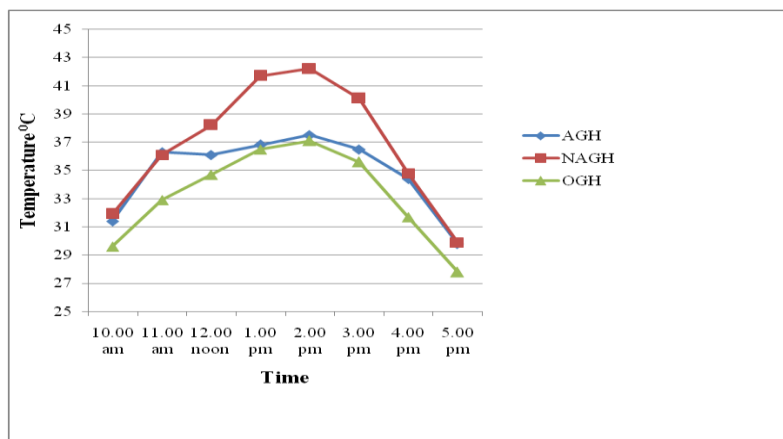

Fig.4.51 Hourly variation of temperature (°C) during fifth week (2nd crop)

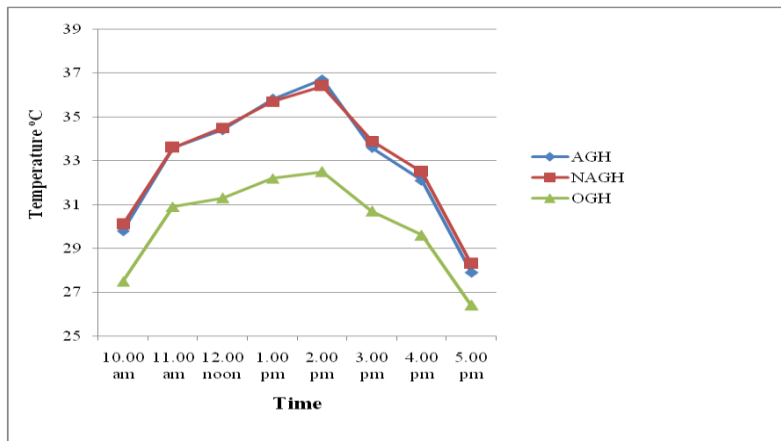

Fig.4.52 Hourly variation of temperature (°C) during sixth week (2nd crop)

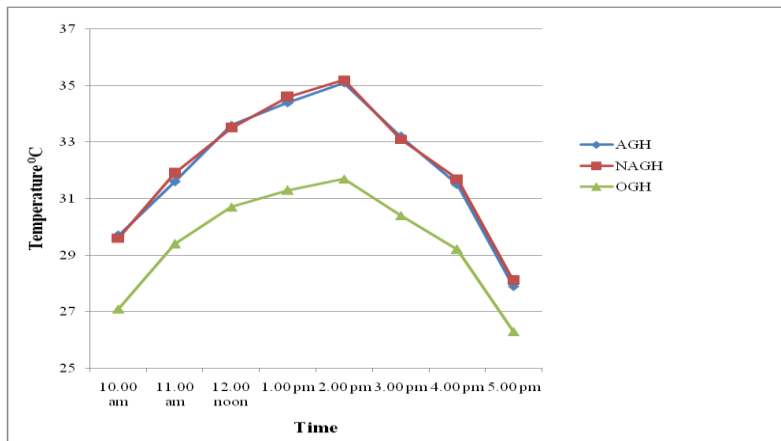

Fig.4.53 Hourly variation of temperature (°C) during seventh week (2nd crop)

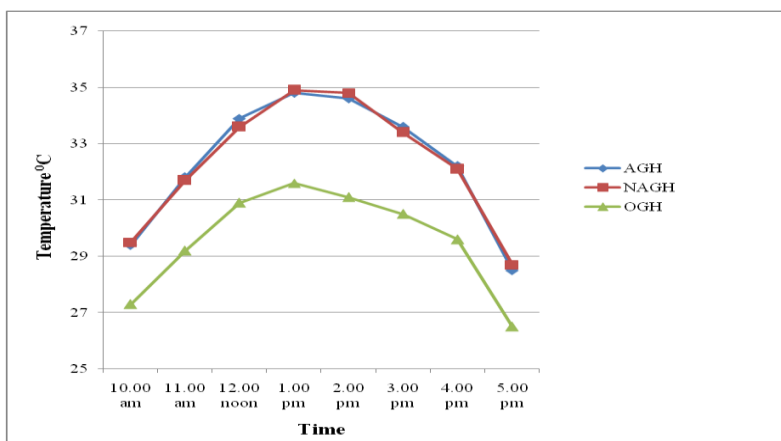

Fig.4.54 Hourly variation of temperature (°C) during eighth week (2nd crop)

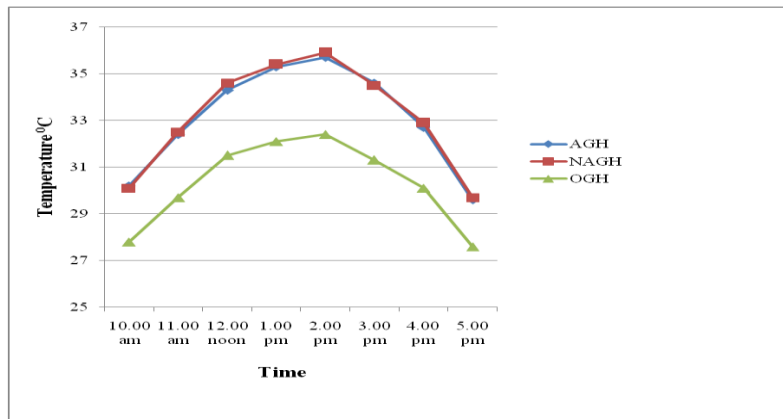

Fig.4.55 Hourly variation of temperature (°C) during ninth week (2nd crop)

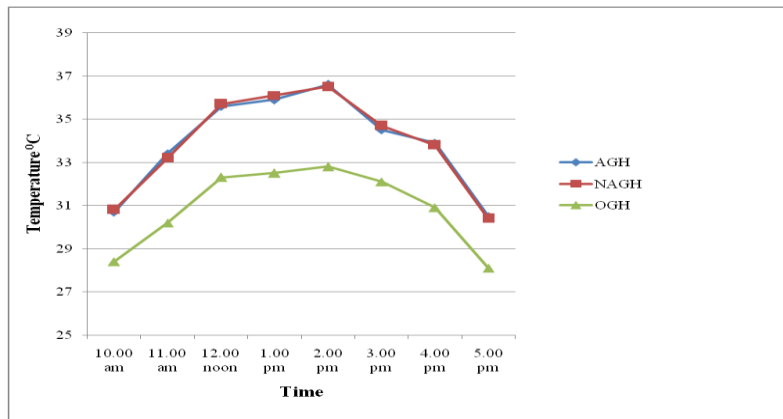

Fig.4.56 Hourly variation of temperature (°C) during tenth week (2nd crop)

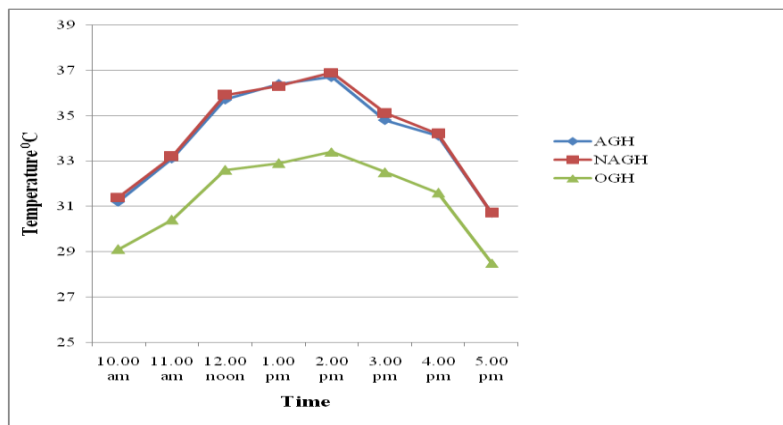

Fig.4.57 Hourly variation of temperature (°C) during eleventh week (2nd crop)

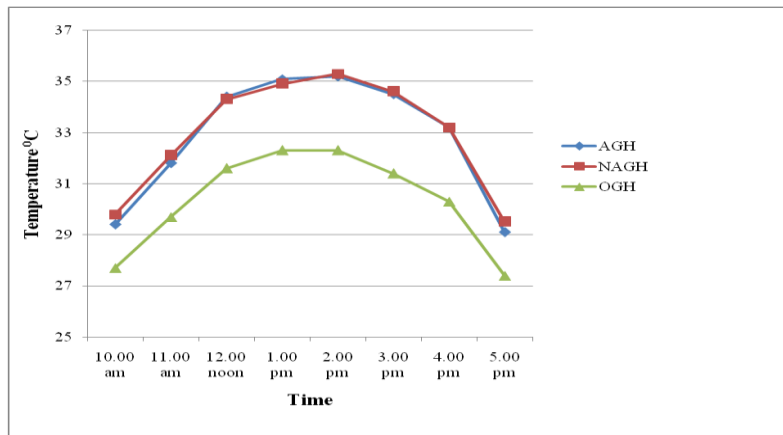

Fig.4.58 Hourly variation of temperature (°C) during twelfth week (2nd crop)

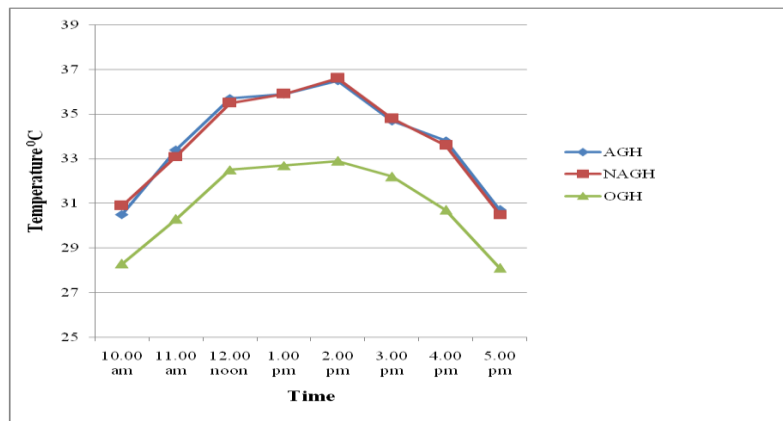

Fig.4.59 Hourly variation of temperature (°C) during thirteenth week (2nd crop)

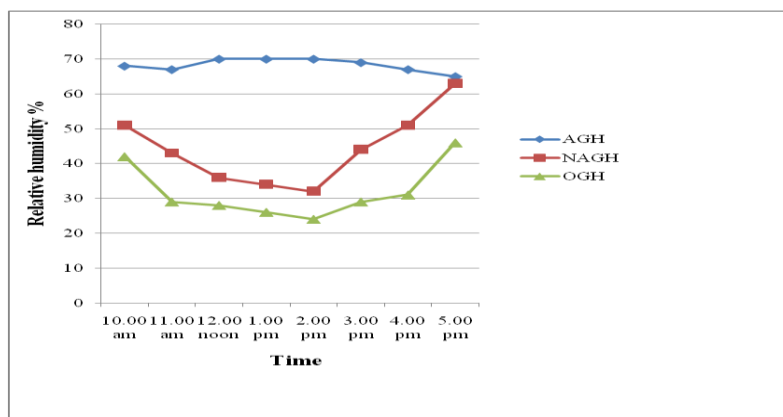

Fig.4.60 Hourly variation of RH during first week (2nd crop)

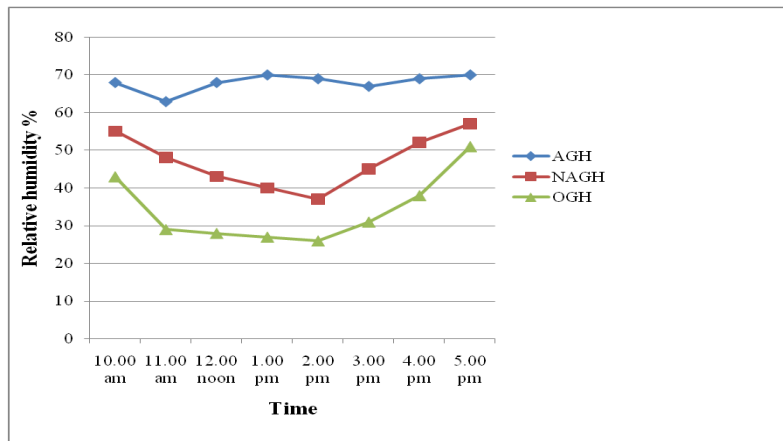

Fig.4.61 Hourly variation of RH during second week (2nd crop)

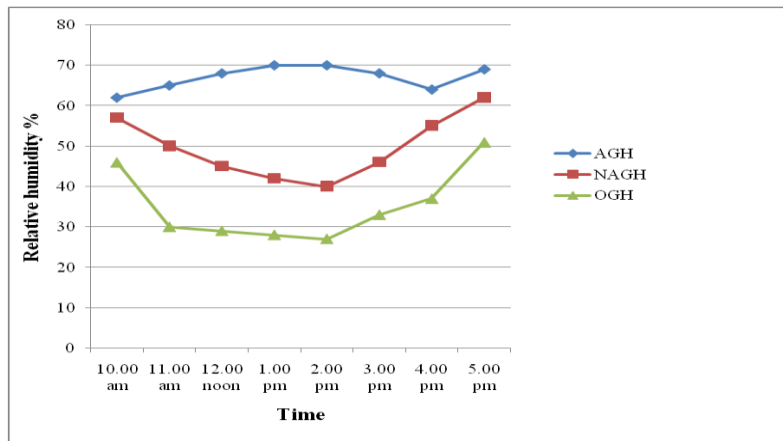

Fig.4.62 Hourly variation of RH during third week (2nd crop)

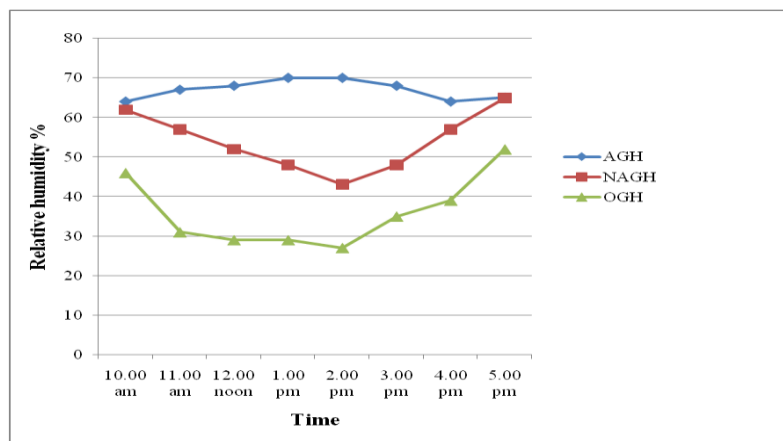

Fig.4.63 Hourly variation of RH during fourth week (2nd crop)

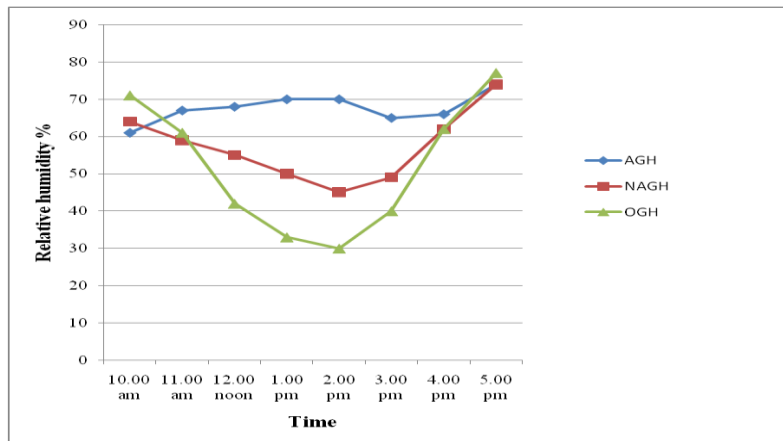

Fig.4.64 Hourly variation of RH during fifth week (2nd crop)

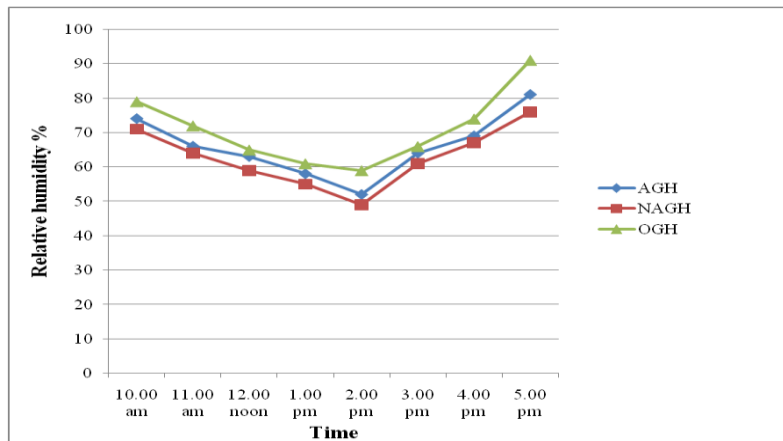

Fig.4.65 Hourly variation of RH during sixth week (2nd crop)

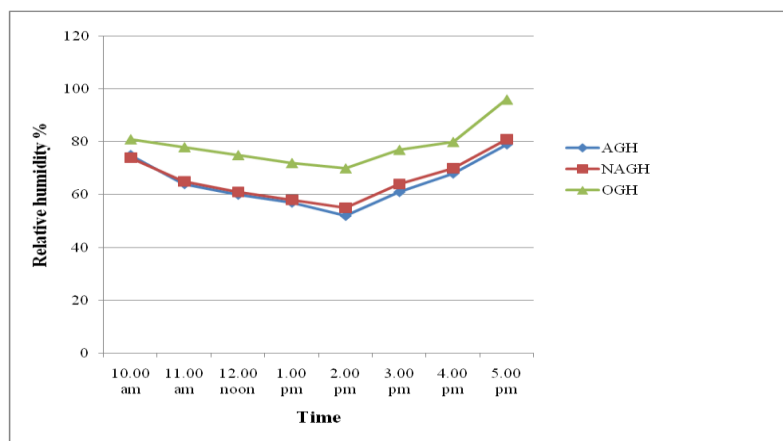

Fig.4.66 Hourly variation of RH during seventh week (2nd crop)

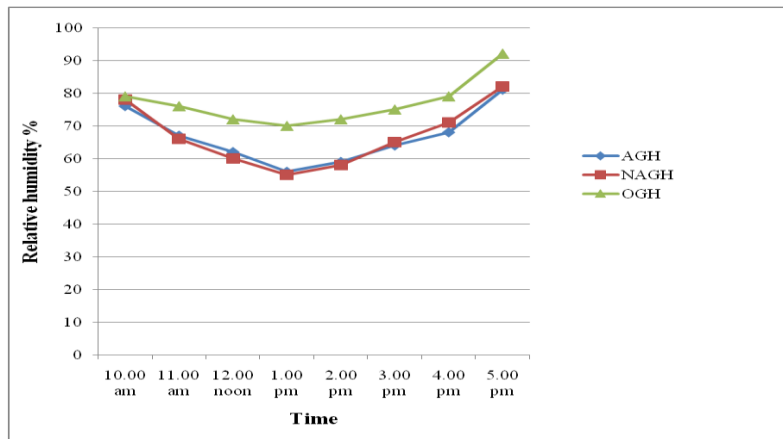

Fig.4.67 Hourly variation of RH during eighth week (2nd crop)

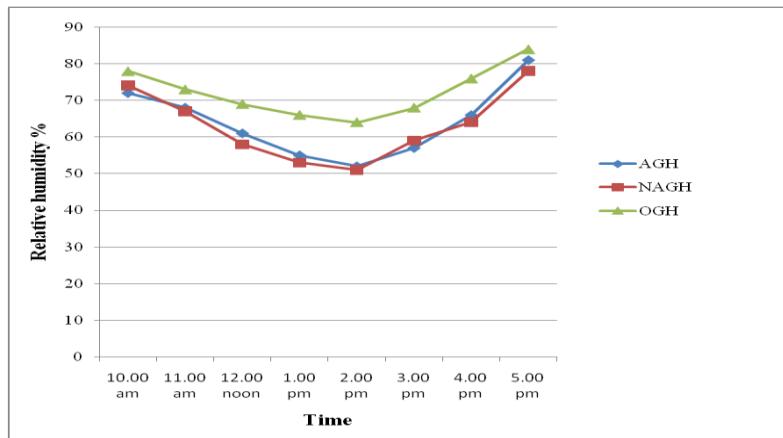

Fig.4.68 Hourly variation of RH during ninth week (2nd crop)

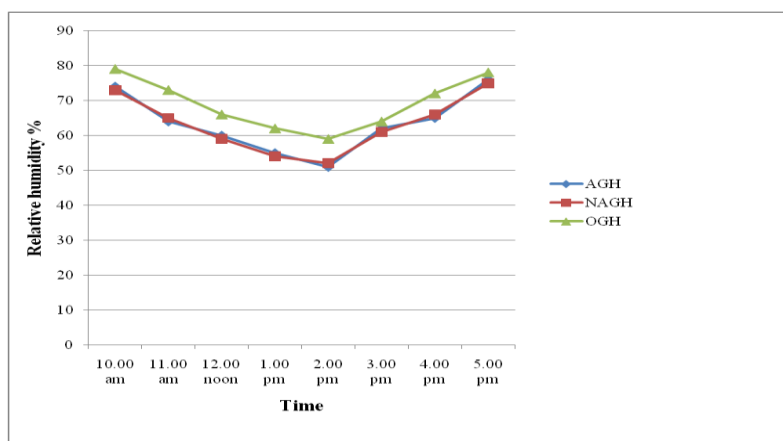

Fig.4.69 Hourly variation of RH during tenth week (2nd crop)

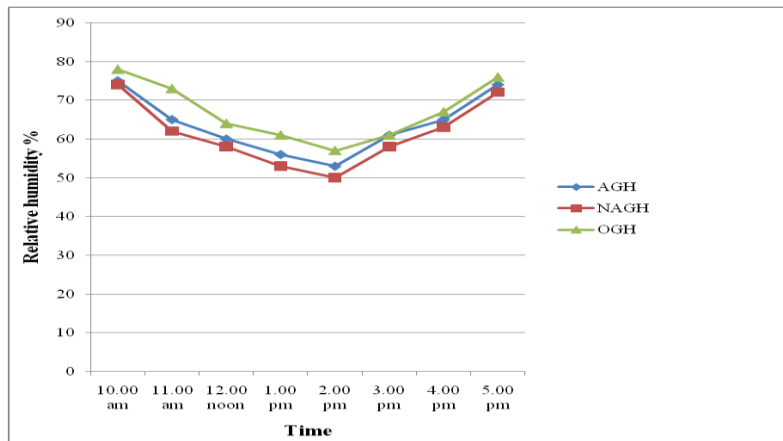

Fig.4.70 Hourly variation of RH during eleventh week (2nd crop)

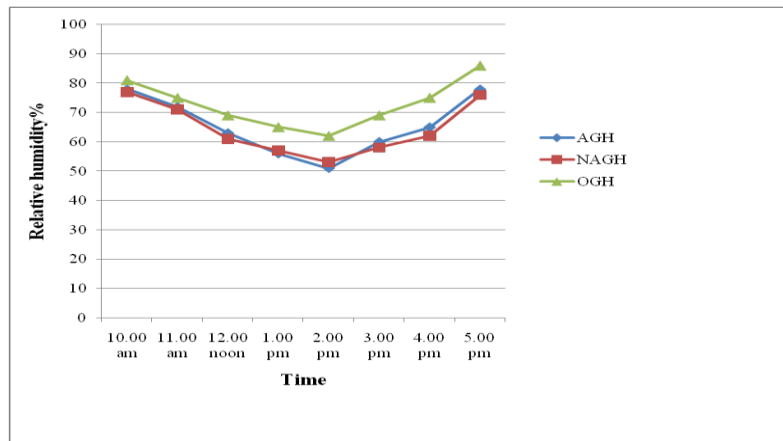

Fig.4.71 Hourly variation of RH during twelfth week (2nd crop)

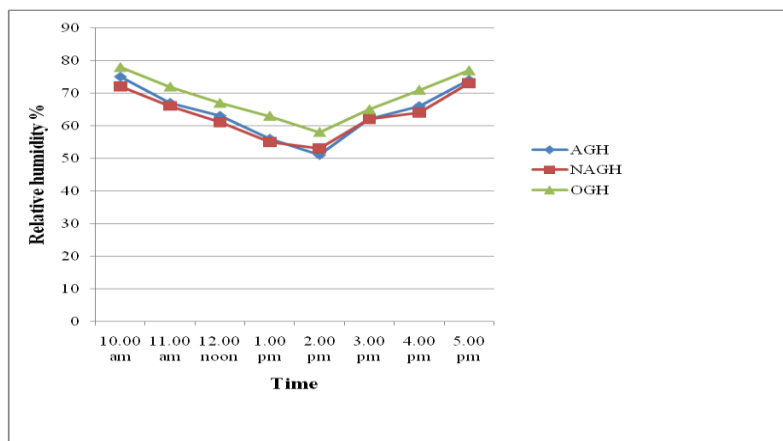

Fig.4.72 Hourly variation of RH during thirteenth week (2nd crop)

Weekly averages of hourly variations of relative humidity values are given in Fig.4.60 to Fig.4.72. During initial five weeks, outside relative humidity values were very low and temperature was very high. After that, because of the rainfall, relative humidity was higher outside. Relative humidity during first week was within 65 % to 70 % during peak hours inside the AGH. In NAGH it was 51 % at 10 am and it reduced to 32 % by 2 pm and then increased to 63 % by 5 pm. Outside RH was 42 % at 10 am and reduced to 24 % by 2 pm, and thereafter increased to 46 % by 5pm. RH was low in NAGH and OGH. During 2nd, 3rd, 4th and 5th weeks, RH values were almost same as that of first week. During these weeks, because of the frequent operation of foggers, RH inside the AGH was within 60 % and 70 % during peak hours. RH inside the AGH never increased above 70 % because of the automation system. At the same time RH never decreased below 50 % inside AGH because that was the minimum RH set inside the greenhouse. But in NAGH RH was less than 50 % and it reduced below 30 % during days with higher temperature. From 6th week to 13th week, because of rainfall, relative humidity was very high outside the greenhouse and temperature was very low. Hence there was no need of any cooling system inside both of the greenhouses and the relative humidity was almost equal inside both the greenhouses. During 6th week RH inside AGH was 74 % at 10 am and it reduced to 52 % by 2 pm and then increased to 81 % by 5 pm. Inside NAGH, relative humidity was 71 % at 10 am and it reduced to 49 % by 2 pm, thereafter increased to 76 % by 5 pm. RH outside the greenhouse was 79 % at 10 am and it reduced to 59 % by 2 pm and then increased to 91 % by 5 pm. RH inside both of the greenhouses were lower during these weeks because of the higher temperature inside greenhouse and non operation of foggers inside the greenhouses. Similar values of RH were noted during remaining weeks also. During 6th week to 13th week, no cooling system was used inside both the AGH and NAGH and hence RH values were almost equal inside both the greenhouses and was lower than outside the greenhouse. From these results it can be concluded that automation system operates foggers only when RH was less than 70 % and temperature was

higher than 37⁰C. Hence it is suitable for managing greenhouse microclimate without much increase of humidity inside greenhouse.

4.2.4 Microclimate Regulation during the Third Crop Season

The average values of microclimate data for third crop are given in Appendix XI. The solar intensity values were similar to the first crop season. Outside average solar intensity was 54123 lux at 10 am and it increased to 70548 lux by 12 noon, thereafter decreased to 37541 lux at 5 pm. Solar intensity was almost same in both the greenhouses. There was no significant difference between solar intensities of AGH and NAGH. The solar intensity values inside the greenhouses increased from 35000 lux to around 49000 lux at 12 noon and then decreased. The variations of temperature inside AGH, NAGH and outside from 10 am to 5 pm are shown in Fig.4.73 and the corresponding values are given in Table 4.30. Temperature inside the NAGH was very high and increased up to 43⁰C by 2 pm and then decreased, whereas in AGH the maximum temperature was 37.5⁰C. Slight increase in temperature than the maximum set value of temperature was due to delay in working of foggers due to the higher humidity inside the greenhouse. During the peak hours the temperature inside the AGH was almost same as that of outside. At the same time, in NAGH, the temperature was very high compared to AGH and it is harmful to the crop also. The variations of RH from 10 am to 5 pm are shown in Fig.4.74 and the corresponding values are given in Table 4.31. Outside RH was 59 % at 10 am and it reduced to 30 % by 2 pm, thereafter increased to 45 % by 5 pm. In NAGH the RH was 52 % at 10 am and decreased to 35 % by 2 pm, thereafter increased to 55 % by 5 pm. In AGH the RH was between 70 and 59 % which lies in the optimum range of RH for the cucumber crop cultivated inside the greenhouse. Mean values of temperature and RH from 10 am to 5 pm are given in Table 4.32. One way ANOVA resulted that there was significant difference in temperature between AGH and NAGH but there was no significant difference between AGH and OGH. There was significant difference of mean temperature between NAGH and OGH. This was

because of the better temperature management in AGH by the automation system. There was significant difference between relative humidity between AGH and NAGH and also between AGH and OGH. From above all we can state that automation system is good for managing the microclimate inside the greenhouse.

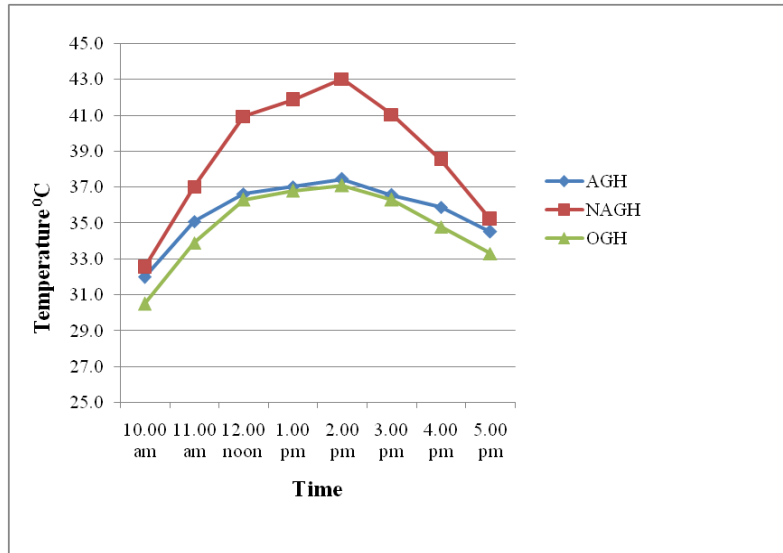

Fig. 4.73 Hourly variation of temperature (°C) during third crop season

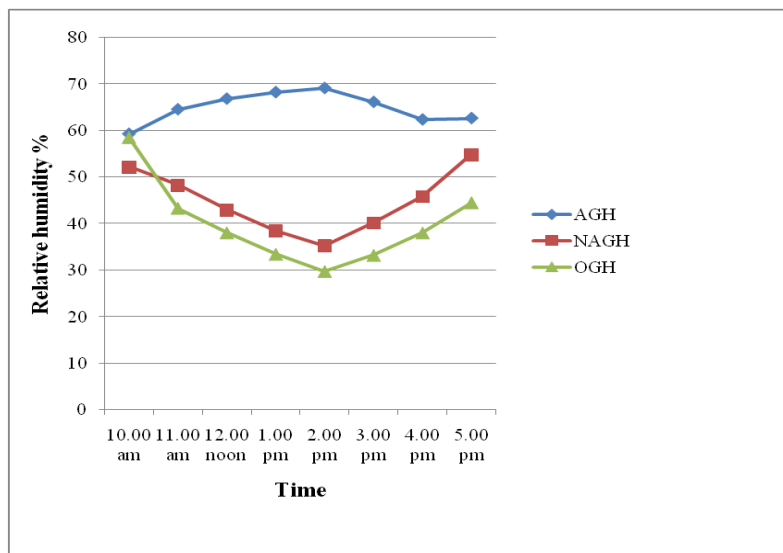

Fig.4.74 Hourly variation of RH (%) during third crop season

Table 4.30 Average temperature inside the greenhouse during third crop season

Time	Temperature °C		
	AGH	NAGH	OGH
10.00 am	32.0	32.5	30.5
11.00 am	35.1	37.0	33.9
12.00 noon	36.6	41.0	36.3
1.00 pm	37.0	41.9	36.8
2.00 pm	37.5	43.0	37.1
3.00 pm	36.6	41.0	36.3
4.00 pm	35.9	38.6	34.8
5.00 pm	34.5	35.2	33.3

Table 4.31 Average RH during third crop season

Time	Relative Humidity %		
	AGH	NAGH	OGH
10.00 am	59	52	59
11.00 am	65	48	43
12.00 noon	67	43	38
1.00 pm	68	39	34
2.00 pm	69	35	30
3.00 pm	66	40	33
4.00 pm	62	46	38
5.00 pm	63	55	45

Table 4.32 Mean Temperature and RH from 10 am to 5 pm during third crop season

	Temperature °C	RH %
AGH	35.7 ^a	65 ^a
NAGH	38.8 ^b	45 ^b
OGH	34.9 ^a	40 ^b

*Values followed by same letters are not significantly different at P<0.05

4.2.4.1 Micro climate Regulation inside the Greenhouse for 1st Month (November 2016) during 3rd Crop Season

The average microclimate data inside AGH, NAGH and outside the greenhouse during November 2016 are given in Appendix XII. The outside solar intensity values were between 38000 lux and 73000 lux during peak hours and inside the greenhouses the values were between 25000 lux to 50000 lux. Solar intensity values were almost same for both the greenhouses. Monthly average values of temperature in AGH, NAGH and outside the greenhouse from 10am to 5pm are given in Table 4.33 and its variation is shown in Fig. 4.75. The curves of AGH and NAGH lies above the curve of OGH but curve of AGH is very nearer to OGH during peak hours. This was because of the better management of microclimate by automation system. In NAGH the temperature was 32.6⁰C at 10 am and it increased to 43.4⁰C by 2 pm, thereafter decreased to 35.9⁰C by 5 pm, while in AGH, the temperature was maintained below 37⁰C for most of the time and only during certain time it increased above 37⁰C. This slight increase of temperature above the maximum set temperature was due to the delay in start of foggers due to the time gap provided in the controller and also due to higher humidity level inside the greenhouse. The variations of RH from 10 am to 5 pm in AGH, NAGH and outside the greenhouse are shown in Fig.4.76 and the corresponding data are given in Table 4.34. The outside RH decreased from 56 % at 10 am to 29 % by 2 pm, thereafter increased to 41 % by 5 pm. From Fig.4.76 it can be seen that in between 11.30 am and 4.30 pm the RH was below 40 % in NAGH, but in AGH the RH was maintained between 50 % and 70 % during peak time. Mean values of temperature and RH from 10 am to 5 pm during November 2016 are given in Table 4.35. One way ANOVA resulted that there was significant difference in temperature between AGH and NAGH but there was no significant difference between AGH and OGH. There was significant difference of mean temperature between NAGH and OGH. This was because of the better temperature management in AGH by the automation system. There was

significant difference between relative humidity between AGH and NAGH and also between AGH and OGH. These results show that automation system is better in microclimate management inside the greenhouse.

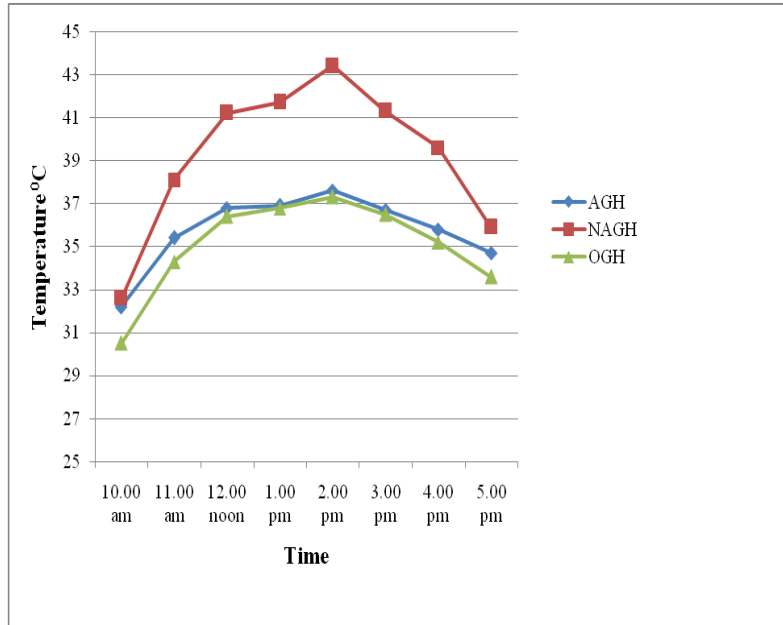

Fig.4.75 Hourly variation of temperature (°C) during November 2016

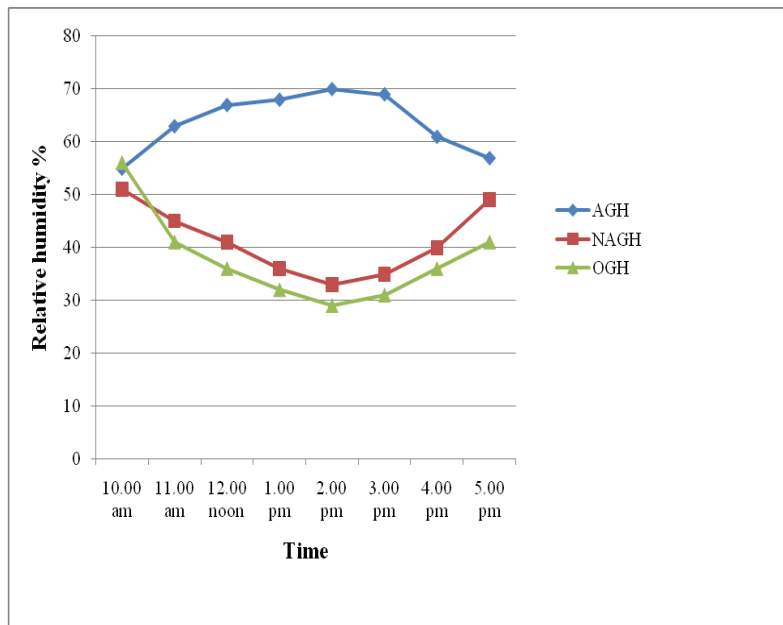

Fig. 4.76 Hourly variation of RH (%) during November 2016

Table 4.33 Average temperatures during November 2016

Time	Temperature °C		
	AGH	NAGH	OGH
10.00 am	32.2	32.6	30.5
11.00 am	35.4	38.1	34.3
12.00 noon	36.8	41.2	36.4
1.00 pm	36.9	41.7	36.8
2.00 pm	37.6	43.4	37.3
3.00 pm	36.7	41.3	36.5
4.00 pm	35.8	39.6	35.2
5.00 pm	34.7	35.9	33.6

Table 4.34 Average RH during November 2016

Time	Relative Humidity %		
	AGH	NAGH	OGH
10.00 am	55	51	56
11.00 am	63	45	41
12.00 noon	67	41	36
1.00 pm	68	36	32
2.00 pm	70	33	29
3.00 pm	69	35	31
4.00 pm	61	40	36
5.00 pm	57	49	41

Table 4.35 Mean values of temperature and RH from 10 am to 5 pm during November 2016

	Temperature °C	RH %
AGH	35.8 ^a	64 ^a
NAGH	39.2 ^b	41 ^b
OGH	35.1 ^a	38 ^b

*Values followed by same letters are not significantly different at P<0.05

4.2.4.2 Microclimate Regulation inside the Greenhouse for 2nd Month (December 2016) during 3rd Crop Season

Hourly microclimatic data from 10am to 5pm inside AGH, NAGH and outside the greenhouse are given in Appendix XIII. Compared to previous month the average solar intensity was lower by about 5000 lux and due to this reason the average temperature inside the greenhouse as well as outside were slightly lesser than that of previous month. Outside solar intensity varied between 36000 and 68000 lux during daytime and inside the greenhouses it varied from 21000 to 45000 lux. In AGH and NAGH the intensity of solar radiations were almost same. The hourly variations of temperature in AGH, NAGH and outside the greenhouse (OGH) from 10 am to 5 pm are shown in Fig.4.77 and the corresponding values are given Table 4.36. The curves of AGH and OGH are very much nearer and while the curve for NAGH lies above AGH and OGH. Outside temperature increased up to 36.6⁰C and then decreased. In NAGH the temperature was 31.5⁰C at 10 am and it increased to 42⁰C by 2 pm, thereafter decreased to 34.3⁰C by 5 pm. In NAGH, during peak hours, temperature was above 38⁰C which is above the desirable temperature limit of the crop inside the greenhouse. While inside the AGH the temperature was maintained within the desirable limit of crop by automatically controlling the cooling system. The hourly variation of RH in AGH, NAGH and OGH are shown in Fig.4.78 and the corresponding values are given Table 4.37. Outside RH was 62 % at 10 am and it decreased to 32 % by 2 pm, thereafter increased to 49 % by 5 pm. In NAGH the RH was 57 % at 10 am and it decreased to 37 % by 2 pm, thereafter increased to 57 % by 5 pm. In AGH the RH was maintained between 60 to 70 % by the automation system. Mean values of temperature and RH from 10 am to 5 pm during December 2016 are given in Table 4.38. One way ANOVA resulted that there was no significant difference in temperature between AGH and NAGH and also there was no significant difference between AGH and OGH. This was because during that month temperature at morning and evening were less. Hence

there was not much difference of temperature at 10 am and 5 pm. but numerically temperature inside AGH was less compared to NAGH. There was significant difference between relative humidity between AGH and NAGH and also between AGH and OGH.

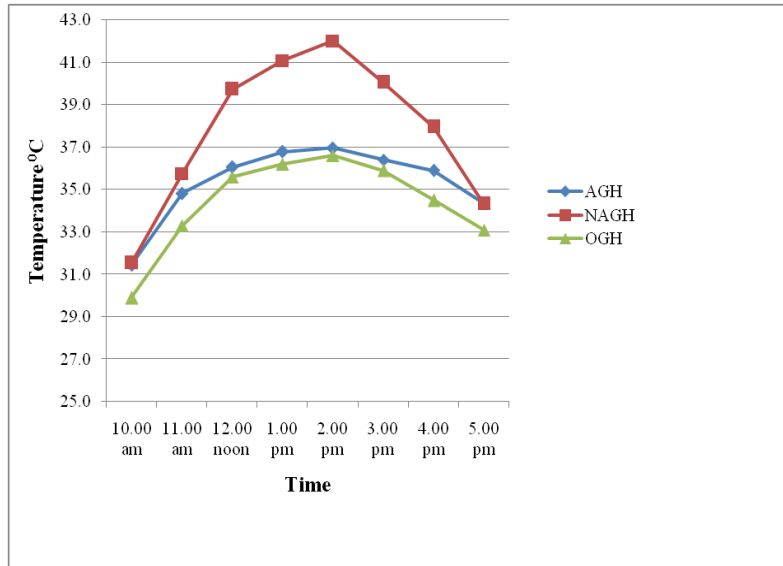

Fig. 4.77 Hourly variation of temperature ($^{\circ}\text{C}$) during December 2016

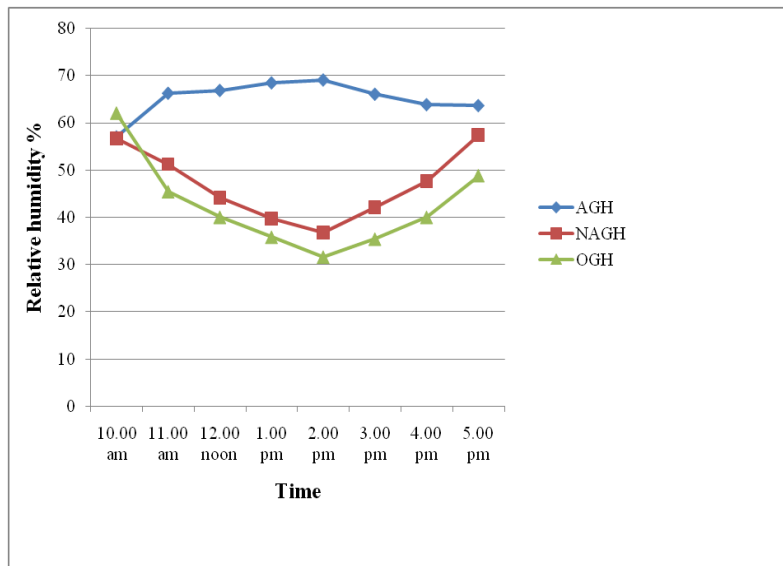

Fig. 4.78 Hourly variation of RH (%) during December 2016

Table 4.36 Average temperature during December 2016

Time	Temperature °C		
	AGH	NAGH	OGH
10.00 am	31.4	31.5	29.9
11.00 am	34.8	35.8	33.3
12.00 noon	36.1	39.7	35.6
1.00 pm	36.8	41.1	36.2
2.00 pm	37.0	42.0	36.6
3.00 pm	36.4	40.1	35.9
4.00 pm	35.9	38.0	34.5
5.00 pm	34.4	34.3	33.1

Table 4.37 Average RH during December 2016

Time	Relative Humidity %		
	AGH	NAGH	OGH
10.00 am	57	57	62
11.00 am	66	51	45
12.00 noon	67	44	40
1.00 pm	68	40	36
2.00 pm	69	37	32
3.00 pm	66	42	35
4.00 pm	64	48	40
5.00 pm	64	57	49

Table 4.38 Mean values of temperature and RH from 10 am to 5 pm during December 2016

	Temperature °C	RH %
AGH	35.3 ^a	65 ^a
NAGH	37.8 ^a	47 ^b
OGH	34.4 ^a	42 ^b

*Values followed by same letters are not significantly different at P<0.05

4.2.4.3 Microclimate Regulation inside the Greenhouse for 3rd Month (January 2017) during 3rd Crop Season

Microclimate data inside AGH, NAGH and OGH during the January 2017 are given in Appendix XIV. Intensity of solar radiation was around 58000 lux at 10 am for OGH and it increased to 69000 lux by 2 pm, thereafter decreased to 35439 lux by 5 pm. Inside AGH and NAGH the solar intensity values were almost same and it varied between 20000 lux and 47000 lux during 10 am to 5 pm. The hourly variation of temperature from 10 am to 5 pm inside AGH, NAGH and OGH are shown graphically in Fig. 4.79 and the corresponding values are given in Table 4.39. During peak hours of the day, the curves of AGH and OGH are overlaying because the temperatures were almost same. Average outside temperature was 30.5⁰C at 10am and it increased to 37.2⁰C by 2 pm, thereafter decreased to 33.4⁰C by 5 pm. Inside the NAGH the temperature increased up to 43.1⁰C. Temperature inside the NAGH was above 38⁰C from 11.30 am to 4.30 pm and this is above the favourable temperature limit of the crop inside the greenhouse. But in AGH the maximum temperature was 37.5⁰C which was within the favourable limit of the crop. The slight increase in temperature during hottest part of day was due to the delay in start of foggers because of the higher humidity level or the time gap between stop and start of foggers. The variation of RH in AGH, NAGH and OGH are shown in Fig.4.80 and the corresponding values are given in Table 4.40. The outside RH was 60 % at 10 am and it reduced to 30 % by 2 pm, thereafter increased to 45 % by 5 pm. In NAGH the RH 52 % at 10 am and reduced to 36 % by 2 pm, there after it increased to 58% by 5 pm. In AGH the RH was in between 59 % and 69 % which lies in the desirable limit of cucumber crop inside the greenhouse. Mean values of temperature and RH from 10 am to 5 pm during January 2017 are given in Table 4.41. One way ANOVA resulted that there was significant difference in temperature between AGH and NAGH but there was no significant difference between AGH and OGH. There was significant difference in temperature between NAGH and OGH. This was

because the temperature inside AGH was lower than NAGH and not much higher than OGH. There was significant difference between relative humidity between AGH and NAGH and also between AGH and OGH. From all these results it can states that the automatic microclimate control system is better than manual microclimate control in greenhouses.

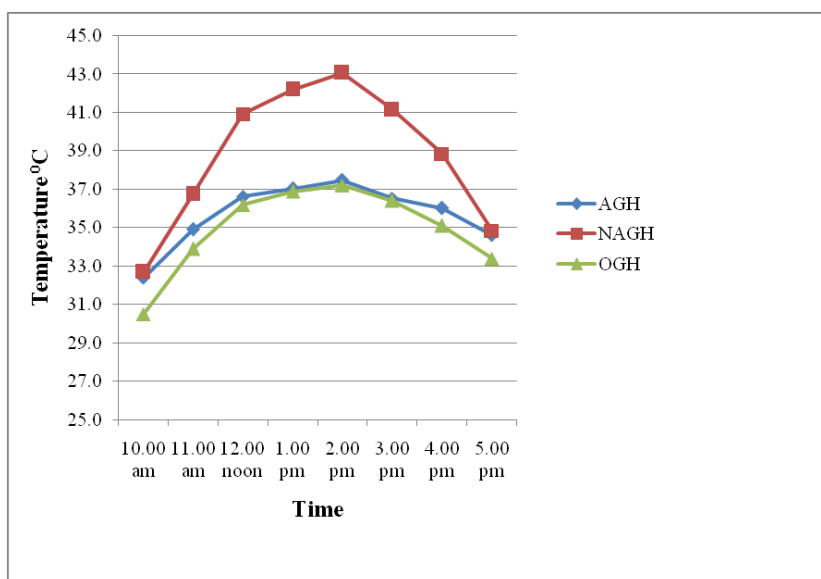

Fig. 4.79 Hourly variation of temperature (°C) during January 2017

Table 4.39 Average temperature during January 2017

Time	Temperature °C		
	AGH	NAGH	OGH
10.00 am	32.4	32.7	30.5
11.00 am	34.9	36.8	33.9
12.00 noon	36.6	40.9	36.2
1.00 pm	37.0	42.2	36.9
2.00 pm	37.5	43.1	37.2
3.00 pm	36.5	41.2	36.4
4.00 pm	36.0	38.9	35.1
5.00 pm	34.6	34.9	33.4

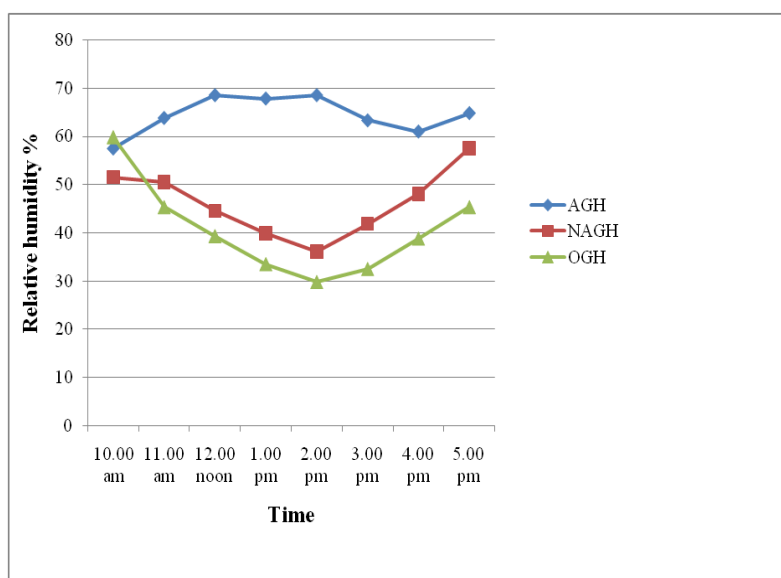

Fig. 4.80 Hourly variation of relative humidity during January 2017

Table 4.40 Average RH during January 2017

Time	Relative Humidity %		
	AGH	NAGH	OGH
10.00 am	58	52	60
11.00 am	64	51	45
12.00 noon	69	45	39
1.00 pm	68	40	34
2.00 pm	69	36	30
3.00 pm	63	42	33
4.00 pm	61	48	39
5.00 pm	65	58	45

Table 4.41 Mean values of temperature and RH from 10 am to 5 pm during January 2017

	Temperature °C	RH %
AGH	35.7 ^a	64 ^a
NAGH	38.8 ^b	46 ^b
OGH	35.0 ^a	41 ^b

*Values followed by same letters are not significantly different at P<0.05

4.2.4.4 Micro climate Regulation inside the Greenhouse for 4th Month (February 2017) during 3rd Crop Season

Hourly microclimate data inside AGH, NAGH and OGH during February 2017 are given Appendix XV. The average outside solar intensity for the month varied from 39000 lux to 73000 lux which is higher than that of previous month. Hence the temperature is also higher than that of previous month. The solar intensity inside both AGH and NAGH are almost same and these are higher than that of previous month. Inside the greenhouses it varied from 24000 lux to 50000 lux. The hourly variation of temperature inside the AGH, inside the NAGH and OGH are shown in Fig.4.81 and the corresponding values are given in Table 4.42. The curve for the AGH lies slightly above the curve for the OGH during initial hours and during peak time the temperature curve for OGH and AGH were very closer, thereafter the temperature curve of AGH comes above the curve of OGH. This shows that the automation system maintained temperature inside the GH within the desirable level of crop inside the greenhouse during peak hours and the temperature inside AGH remained almost same as that of OGH. In NAGH the temperature was 33.3⁰C at 10 am and it increased to 43.6⁰C by 2 pm, thereafter decreased to 35.8⁰C by 5 pm. During peak hours, the temperature inside NAGH was above 38⁰C and it was not favourable for crop inside the greenhouse. But in AGH the temperature was not very high during peak hours. The hourly variations of RH from 10 am to 5 pm inside AGH, NAGH and OGH are shown in Fig.4.82 and the corresponding values are given in Table 4.43. Outside RH was 57 % at 10 am and it reduced to 29 % by 2 pm, thereafter increased to 43 % by 5 pm. In NAGH the RH the corresponding values are 50, 35 and 56 % at 10 am, 2 pm and 5 pm, respectively. But in AGH the RH was between in 65 % and 70 % during peak hours. Mean values of temperature and RH from 10 am to 5 pm during January 2017 are given in Table 4.44. One way ANOVA resulted that there was significant difference in temperature between AGH and NAGH but there was no significant difference between AGH and OGH. There was significant difference

in temperature between NAGH and OGH. This was because the temperature inside AGH was lower than NAGH and not much higher than OGH. There was significant difference between relative humidity between AGH and NAGH and also between AGH and OGH. For reduction of temperature to the desirable limit of crop, the foggers worked inside AGH whenever the temperature was above 37⁰C and below 65 % RH and it worked until either the temperature reduced below 33⁰C or the RH becomes 70 %. Hence the mean RH inside AGH was higher than NAGH and OGH. These results show that the automation system maintained the microclimate inside the AGH better than the NAGH.

Table 4.42 Average temperature during February 2017

Time	Temperature ⁰ C		
	AGH	NAGH	OGH
10.00 am	32.0	33.3	31.2
11.00 am	35.3	37.5	34.2
12.00 noon	37.0	42.0	36.8
1.00 pm	37.4	42.5	37.1
2.00 pm	37.8	43.6	37.4
3.00 pm	36.6	41.7	36.2
4.00 pm	35.9	37.8	34.3
5.00 pm	34.4	35.8	33.2

Table 4.43 Average RH during February 2017

Time	Relative Humidity %		
	AGH	NAGH	OGH
10.00 am	68	50	57
11.00 am	65	46	42
12.00 noon	65	42	37
1.00 pm	69	38	33
2.00 pm	69	35	29
3.00 pm	66	42	34
4.00 pm	64	48	38
5.00 pm	65	56	43

Table 4.44 Mean values of temperature and RH from 10 am to 5 pm during February 2017

	Temperature °C	RH %
AGH	35.8 ^a	66 ^a
NAGH	39.3 ^b	45 ^b
OGH	35.1 ^a	39 ^b

*Values followed by same letters are not significantly different at P<0.05

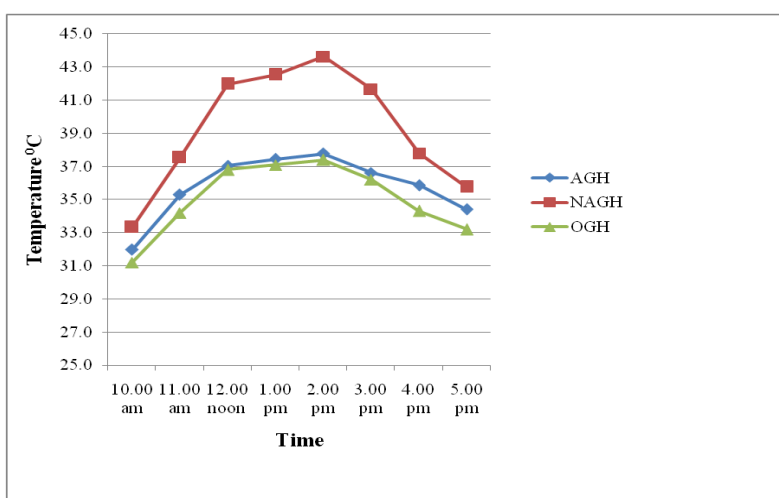

Fig.4.81 Hourly variation of temperature (°C) during February 2017

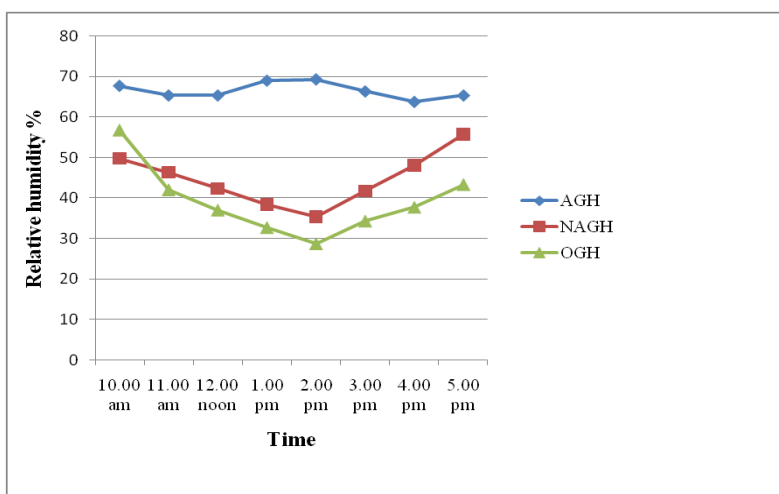

Fig.4.82 Hourly variation of RH (%) during February 2017

4.2.4.5 Weekly Microclimate Variation during Third Crop Season

Temperature inside the greenhouse was recorded at hourly intervals in AGH, NAGH and OGH. Weekly averages of hourly variations of temperatures inside AGH, NAGH and OGH are shown in Fig.4.83 to Fig. 4.95. During first week, temperature inside AGH was above 37⁰C at 2 pm only and during rest of the time it was maintained below 37⁰C. But in NAGH temperature was above 38⁰C during peak hours. In NAGH temperature was 32.6⁰C at 10 am and it increased to 43.4⁰C by 2 pm, thereafter decreased to 35.9⁰C by 5 pm. Temperature outside the greenhouse was 30.5⁰C at 10 am and increased to 37.3⁰C by 2 pm, thereafter decreased to 33.6⁰C by 5 pm. Temperature inside AGH was nearer to that of OGH during peak hours. This was because of the cooling system operated by automation system. Temperature during second week was a little lower than that of first week. Inside the AGH, temperature was maintained below 37⁰C during peak hours. In NAGH increased up to 41.6⁰C and it was above 37⁰C during peak hours. Temperature outside the greenhouse was 30.2⁰C at 10 am and it increased to 36.5⁰C by 2 pm, thereafter decreased to 32.7⁰C by 5 pm. Temperature during 3rd week was similar to that of 1st week. During 4th, 5th and 6th week temperatures were almost equivalent to that of 2nd week. Temperature inside AGH was maintained below 37⁰C, but in NAGH it was above 37⁰C during peak hours. Temperature during 7th week was almost similar to that of 3rd week. Only at 2 pm, temperature inside AGH exceeded 37⁰C. This was due to the high outside temperature and because of that greenhouse temperature also was very high. For the reduction of temperature, frequent operation of foggers was required without any restriction of relative humidity level inside the greenhouse. But because of the pre set values of controller foggers will stop working when RH becomes 70% and then it will restart only after 5 minutes. Hence there was a slight increase in temperature during hottest part of the day. But compared to NAGH, temperature inside the AGH was very low during peak hours. Temperature inside AGH during 8th week was above 37⁰C at 1 pm and 2 pm and

rest of the time it was maintained below 37⁰C. But in NAGH it was above 38⁰C during peak hours and most of the time it was above 41⁰C. Temperature during 9th week was higher than that 8th week. Temperature inside AGH increased up to 38.1⁰C at 2pm. this was because of the higher outside temperature. But compared to NAGH, temperature inside the AGH was lower 5⁰C during peak hours. Temperature during 10th week was almost same as that of 8th week and during 11th, 12th and 13th week temperature was almost similar to that of 9th week. From all these results it can be concluded that for the temperature management automation system is better compared to manual temperature control.

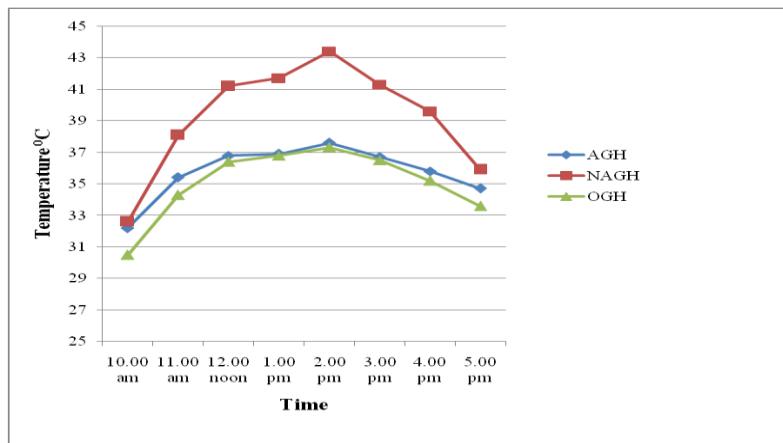

Fig.4.83 Hourly variation of temperature (°C) during first week (3rd crop)

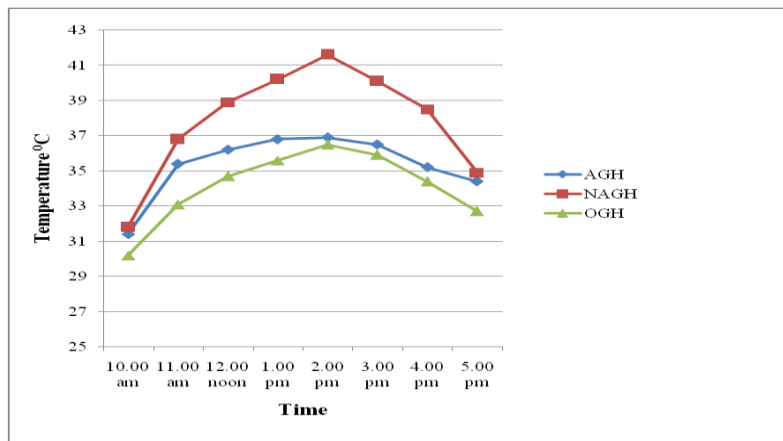

Fig.4.84 Hourly variation of temperature (°C) during second week (3rd crop)

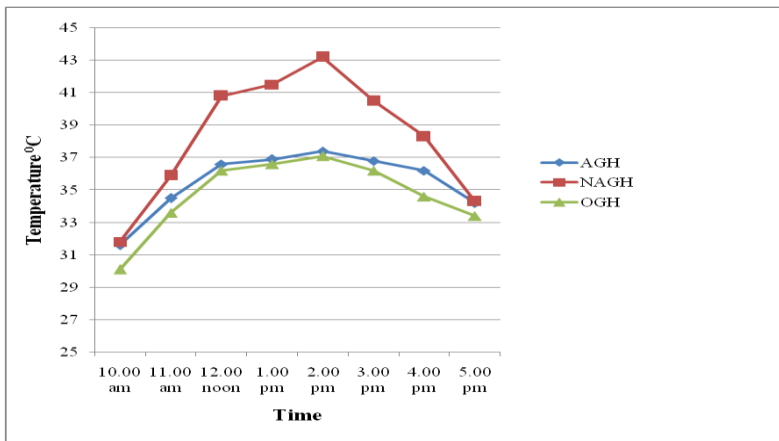

Fig.4.85 Hourly variation of temperature (°C) during third week (3rd crop)

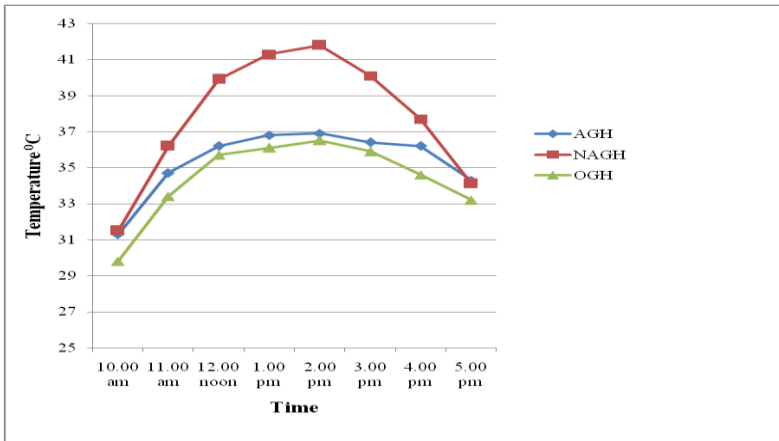

Fig.4.86 Hourly variation of temperature (°C) during fourth week (3rd crop)

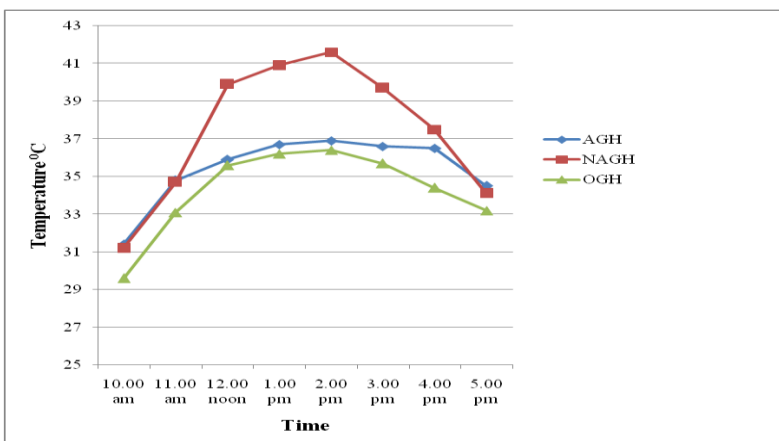

Fig.4.87 Hourly variation of temperature (°C) during fifth week (3rd crop)

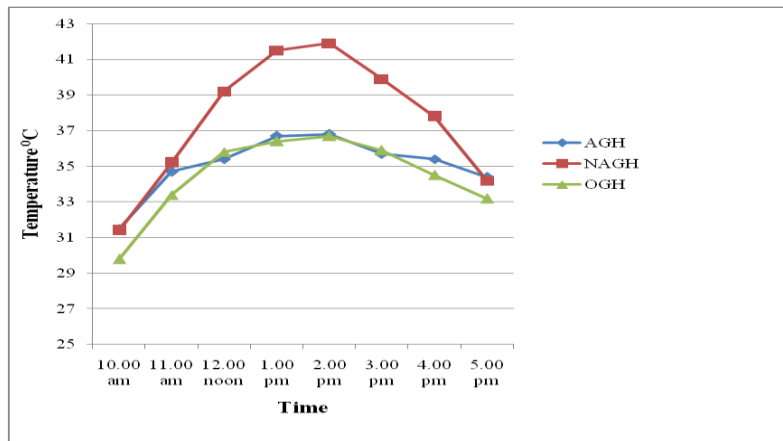

Fig.4.88 Hourly variation of temperature (°C) during sixth week (3rd crop)

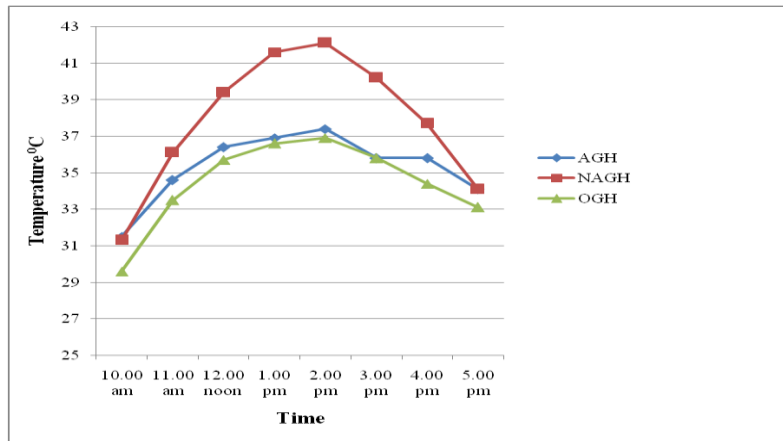

Fig.4.89 Hourly variation of temperature (°C) during seventh week (3rd crop)

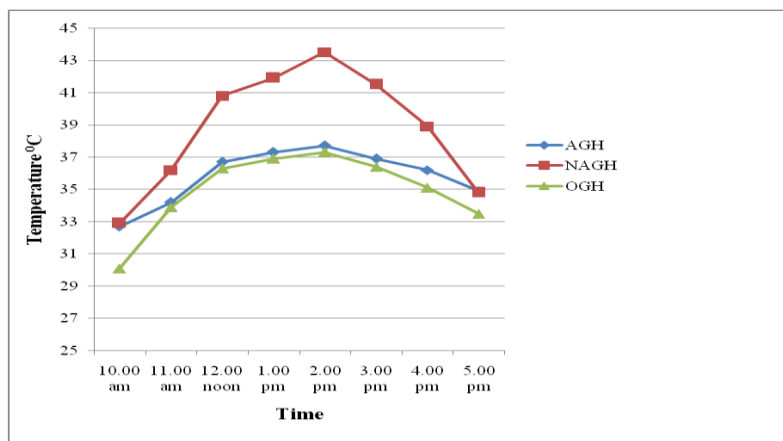

Fig.4.90 Hourly variation of temperature (°C) during eighth week (3rd crop)

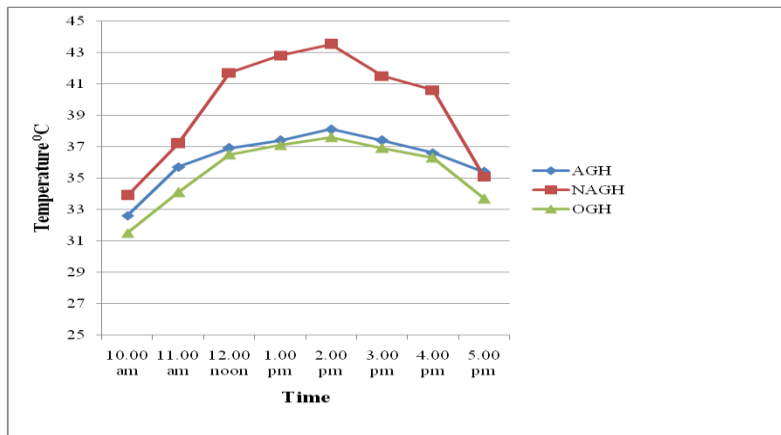

Fig.4.91 Hourly variation of temperature (°C) during ninth week (3rd crop)

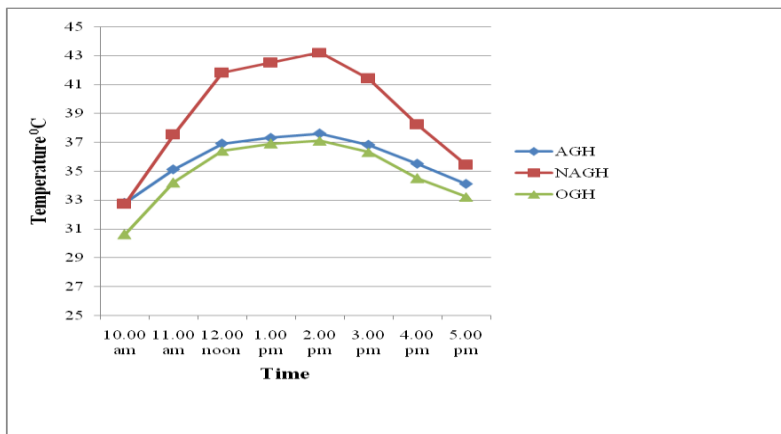

Fig.4.92 Hourly variation of temperature (°C) during tenth week (3rd crop)

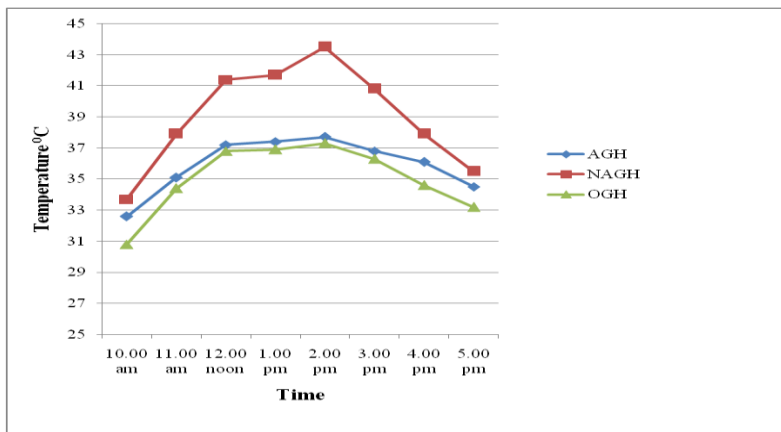

Fig.4.93 Hourly variation of temperature (°C) during eleventh week (3rd crop)

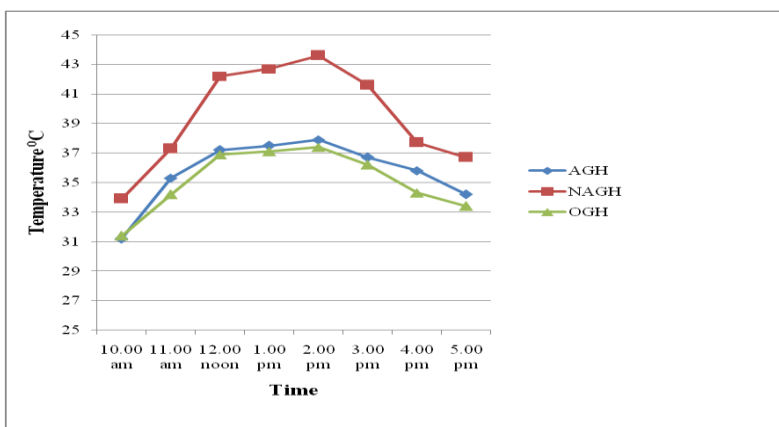

Fig.4.94 Hourly variation of temperature (°C) during twelfth week (3rd crop)

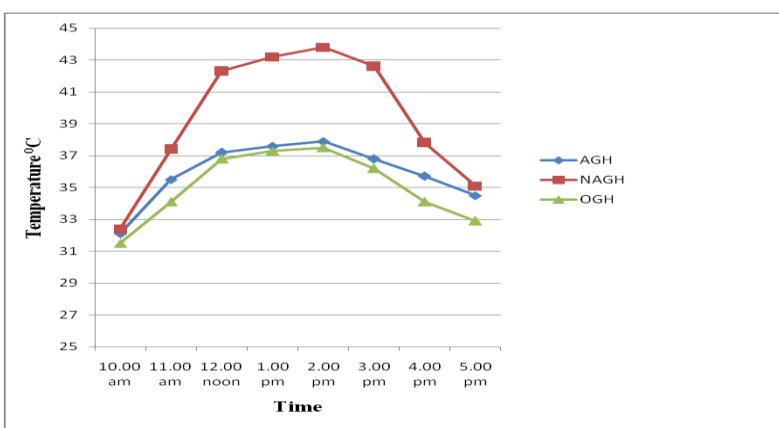

Fig.4.95 Hourly variation of temperature (°C) during thirteenth week (3rd crop)

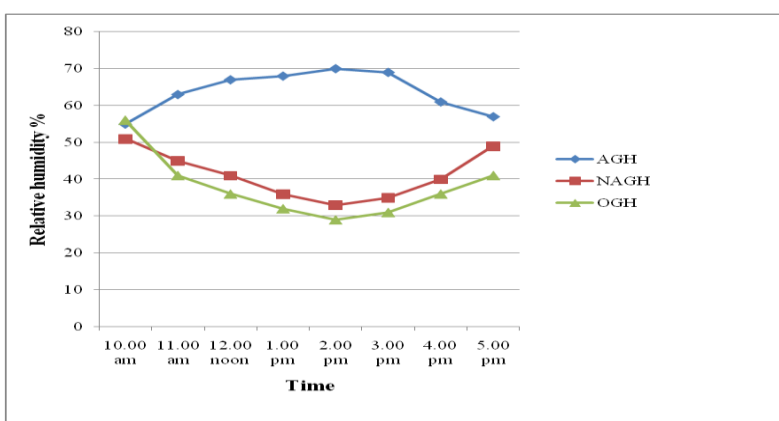

Fig.4.96 Hourly variation of RH during first week (3rd crop)

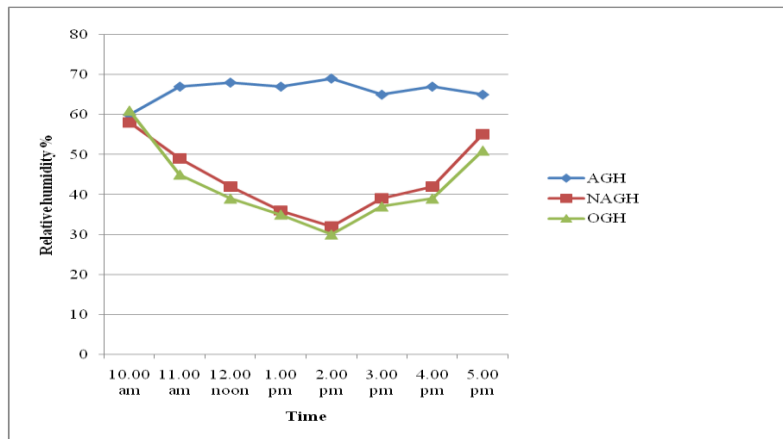

Fig.4.97 Hourly variation of RH during second week (3rd crop)

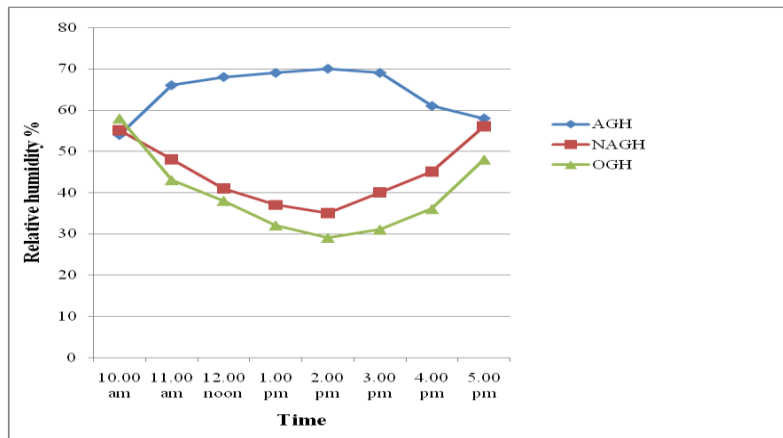

Fig.4.98 Hourly variation of RH during third week (3rd crop)

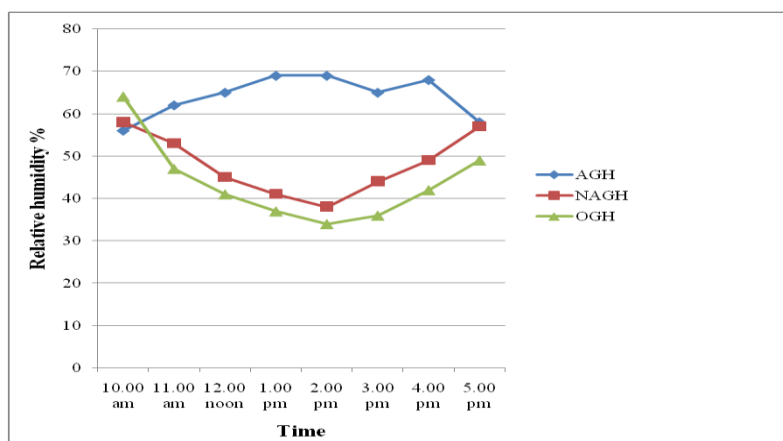

Fig.4.99 Hourly variation of RH during fourth week (3rd crop)

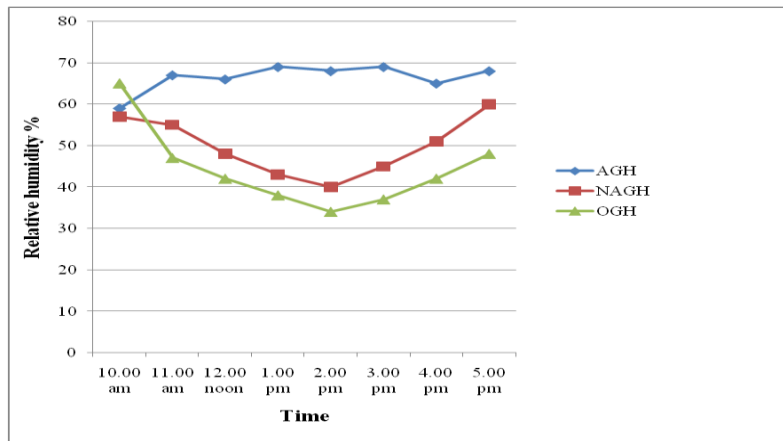

Fig.4.100 Hourly variation of RH during fifth week (3rd crop)

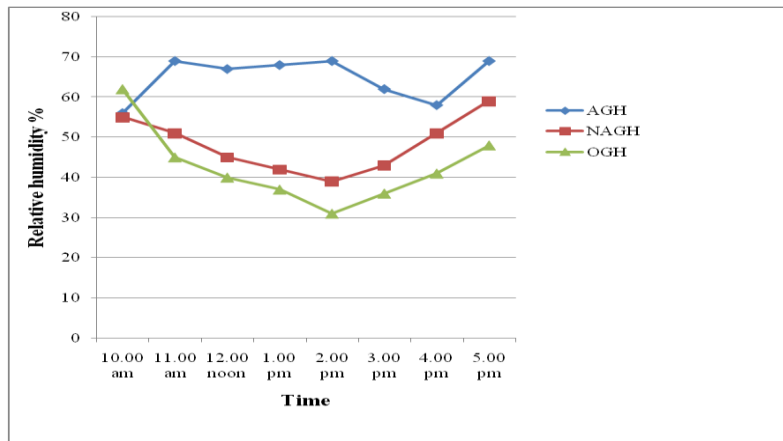

Fig.4.101 Hourly variation of RH during sixth week (3rd crop)

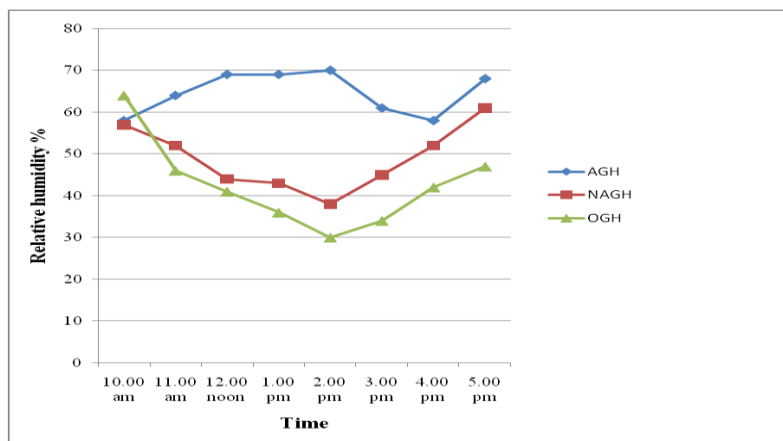

Fig.4.102 Hourly variation of RH during seventh week (3rd crop)

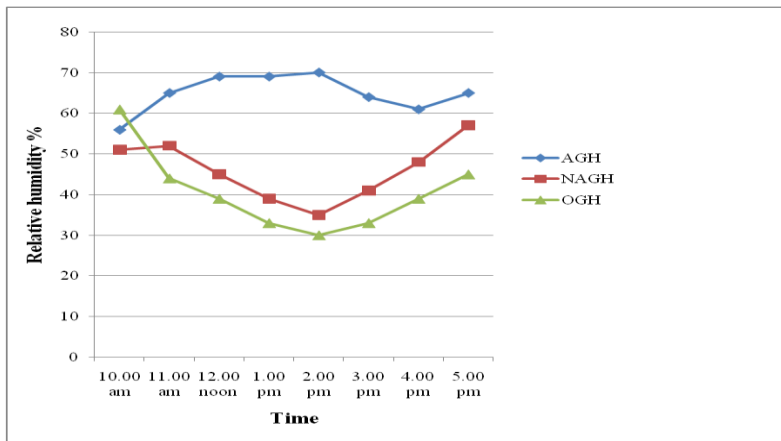

Fig.4.103 Hourly variation of RH during eighth week (3rd crop)

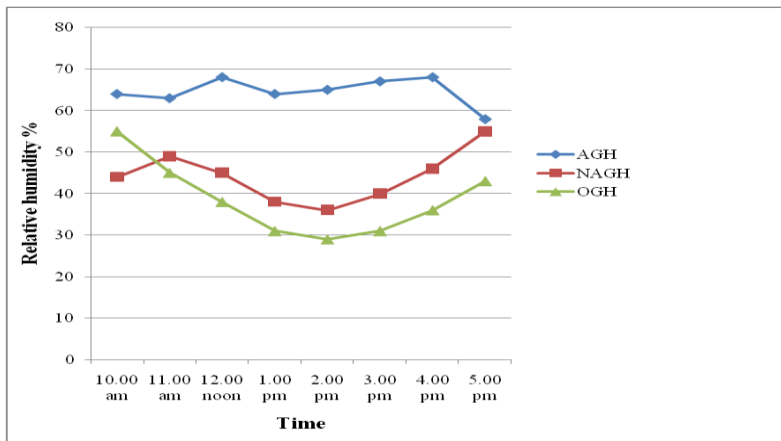

Fig.4.104 Hourly variation of RH during ninth week (3rd crop)

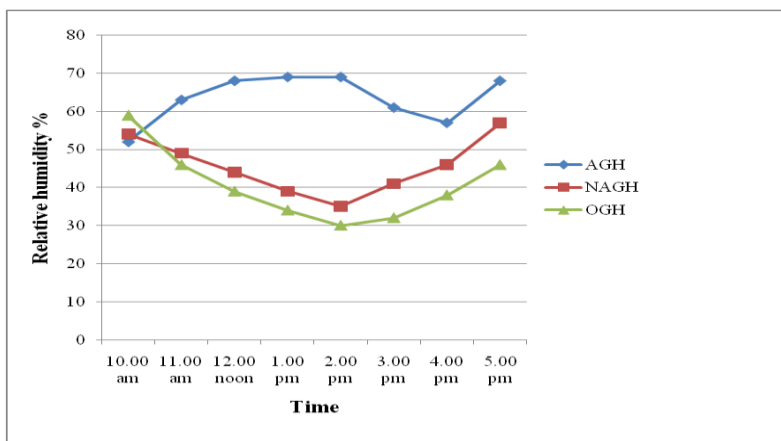

Fig.4.105 Hourly variation of RH during tenth week (3rd crop)

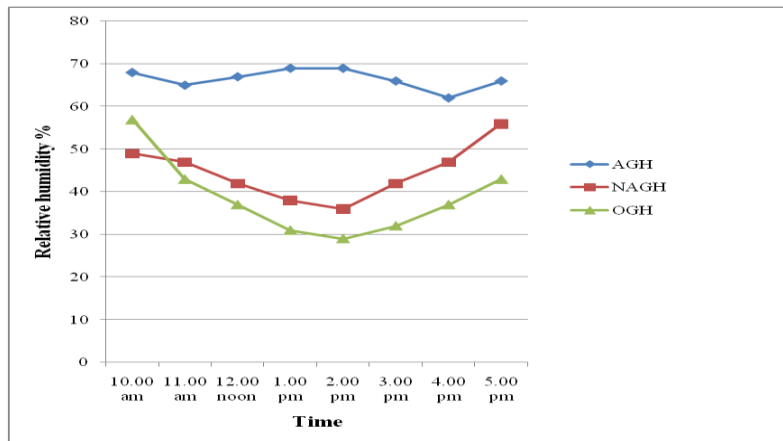

Fig.4.106 Hourly variation of RH during eleventh week (3rd crop)

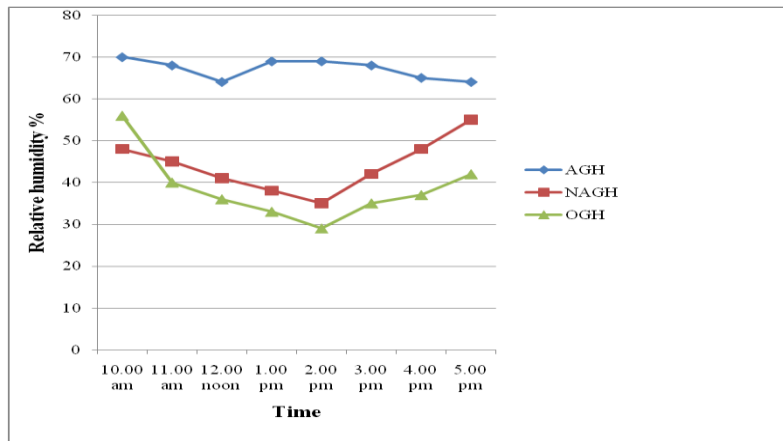

Fig.4.107 Hourly variation of RH during twelfth week (3rd crop)

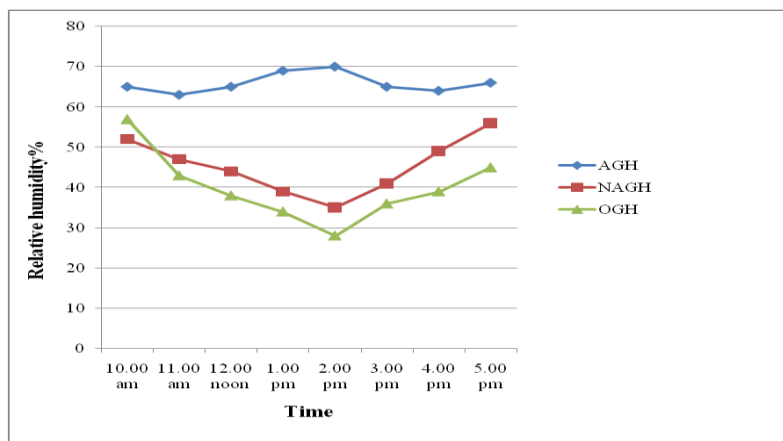

Fig.4.108 Hourly variation of RH during thirteenth week (3rd crop)

Hourly relative humidity values were measured inside AGH, NAGH and OGH. Weekly average of hourly variations of RH for the third crop season are given in Fig.4.96 to Fig.4.108. Relative humidity during first week was within 55% and 70 % inside AGH. In NAGH, RH was 51 % at 10 am and it reduced to 33% by 2 pm, thereafter it increased to 49% by 5 pm. Outside RH was 56% at 10 am which reduced to 29% by 2 pm, thereafter increased to 41% by 5 pm. Up to 10 am in the morning, RH outside the greenhouse was higher compared to that of inside as the foggers did not operate till that time. After 10 am outside RH was lower compared to both the greenhouses because of the operation of foggers inside the greenhouse. Trend of the curves of RH for NAGH and OGH were similar. In the case AGH, curve is different because the RH inside the AGH was within 55 % and 70 % due to automation system. Outside RH was below 40% during peak hours. Inside the NAGH also RH was very low and it was below 40% during peak hours. RH inside AGH never exceeded 70 % while managing temperature and at the same time it was maintained above 50 % during peak hours. Hence from all these it can be concluded that automatic microclimate control inside the greenhouse is better than manual method of microclimate control inside the greenhouse.

4.2.5 Performance of Automation System for Managing Microclimate inside the Greenhouse

From the three trials it was observed that temperature inside the AGH was lower than NAGH and at the same time relative humidity inside the AGH never exceeded 70%. During first season temperature inside AGH was 3.3⁰C lower in AGH than NAGH. During second season temperature in AGH was 1.3⁰C lower than NAGH and during third crop season the temperature in AGH was 3.1⁰C lower than NAGH. Mean RH inside AGH was 63.1 %, 66 % and 65 % during first, second and third season respectively. During first and third season temperature data were similar and during second season because of rainfall temperature was less. Hence there was no need of operation of cooling system in

greenhouses and hence the temperature inside both the greenhouses was almost same during two months of that season. Remaining period of the study temperature inside AGH was lower than NAGH. These indicate that better temperature management can be done by automation system. These results are in agreement with that of Linker *et al.* (2011). They developed an automation system, tested and reported that temperature inside the automated greenhouse was lower than manually controlled one. These results are similar to that reported by Dondapadi and Rajlu (2012) after developing and testing greenhouse automation system based on real time data. The results are also in harmony with Kohle and Annadate (2012) and also with Vidyasagar (2012). Automation system developed by Kohle and Annadate used LPC 2148 microcontroller and Vidyasagar used PIC16F877A microcontroller. Both were reported that compared to manually controlled greenhouse, more reduction of temperature can be achieved in automatically controlled greenhouse. Similar results were reported by Gayathri(2013), Salleh *et al.*(2013), Dinessh and Saravanan (2014), Eldhose et al. (2014) and Baja and Krejcar (2015).

In all the above works cooling system used was evaporative cooling. The temperature inside the naturally ventilated greenhouse will be higher than outside because of the presence of covering material and it can be reduce to wet bulb temperature by using evaporative cooling, Salokhe and Sharma (2012). But the problems of excess build up of relative humidity inside the greenhouse if the foggers are not operated based on the real time data of temperature and relative humidity inside the greenhouse. In manually controlled greenhouses fans and foggers were operated at predefined intervals. But in automated greenhouses, based on real time temperature and relative humidity inside the greenhouse management can be done. In our present study of automation system using subzero 9922 microcontroller, threshold values can be set for temperature and relative humidity. Hence temperature it was able to lower the temperature inside the greenhouse without increasing the relative humidity above the set value 70%.

During evaporative cooling, the conversion of sensible heat into latent heat takes place. The heat load is with the evaporated water and hence it is to be removed from the greenhouse. By using exhaust fans, the humid air was removed from the greenhouse and the dry air from outside comes into the greenhouse. In the present study whenever the temperature exceeds the threshold level of 37⁰C and if the relative humidity was less than or equal to 65 %, then foggers and fans were worked until the temperature becomes less than 33⁰C or the relative humidity equals 70 %. If the temperature and RH are above the threshold level, then fans will work until the RH less than 65 %. Then foggers and fans will be worked. Thus in automated greenhouse, humid air was removed by the automation system in order to avoid excess RH and also to facilitate evaporative cooling. Evaporative cooling can be done only if the relative humidity is less. Thus by the operation of exhaust fans and foggers based on real time data the better cooling inside the automated greenhouse achieved.

4.3 AUTOMATIC IRRIGATION AND FERTIGATION.

The automation system not only manages the microclimate inside the greenhouse but can also manage irrigation and fertigation inside the greenhouse. Manual irrigation and fertilizer application are time consuming and laborious process. The refined version of automation system is capable of irrigating and fertigating the crop at pre-defined intervals with pre-defined quantity.

4.4 CROP RESPONSE TO THE AUTOMATION SYSTEM

Performance of the refined automation system was evaluated from the crop data of cucumber crop of Saniya variety cultivated inside the automated greenhouse and in non automated greenhouse. In order to compare the crop data from these greenhouses another set of plants were cultivated outside the greenhouse. The biometric as well as yield data collected from these were analysed. The important dates for the three crop seasons are given in Tables 4.45 to 4.47. Sowing and transplanting of the plants were done on the same day in

AGH, NAGH and OGH during all the three crop seasons. During all the crop seasons the crops cultivated inside the automated greenhouse showed the best performance for all the flowering parameters. It was followed by crops inside NAGH and the crops outside the greenhouse showed the worst performance. The crops inside the greenhouse gives better results compared to that of outside previously reported by Gokul and Hakkim (2016) and Sunny and Hakkim (2017). This result is in agreement with their findings. The best performance by the crops inside the AGH can be attributed to the better management of microclimate inside the greenhouse and also because of the automated irrigation and fertigation. These results proved that automated greenhouse is better than non automated greenhouse.

Table4.45. Important dates during first crop season

Events	AGH	NAGH	OGH
Sowing	7/12/2015	7/12/2015	7/12/2015
First leaf	9/12/2015	9/12/2015	9/12/2015
Second leaf	13/12/2015	13/12/2015	13/12/2015
Transplanting	14/12/2015	14/12/2015	14/12/2015
First flower bud	27/12/2015	28/12/2015	28/12/2015
First flowering	4/1/2016	7/1/2016	9/1/2016
50% flowering	7/1/2016	10/1/2016	12/1/2016
First fruit	6/1/2016	10/1/2016	12/1/2016
First harvest	15-01-16	19-01-16	21-01-16
Removal of plant	15/3/2016	15/3/2016	15/3/2016

Table4.46. Important dates during second crop season

Events	AGH	NAGH	OGH
Sowing	25/04/2016	25/04/2016	25/04/2016
First leaf	27/04/2016	27/04/2016	27/04/2016
Second leaf	1/5/2016	1/5/2016	1/5/2016
Transplanting	2/5/2016	2/5/2016	2/5/2016
First flower bud	14/5/16	16/5/16	18/5/16
First flowering	22/5/16	26/5/16	29/5/16
50% flowering	26/5/16	30/5/16	1/6/2016
First fruit	24/5/16	29/5/16	31/5/16
First harvest	1/6/2016	6/6/2016	8/6/2016
Removal of plant	2/8/2016	2/8/2016	2/8/2016

Table4.47. Important dates during third crop season

Events	AGH	NAGH	OGH
Sowing	15/11/2016	15/11/2016	15/11/2016
First leaf	17/11/2016	17/11/2016	17/11/2016
Second leaf	19/11/2016	19/11/2016	19/11/2016
Transplanting	22/11/2016	22/11/2016	22/11/2016
First flower bud	5/12/2016	8/12/2016	9/12/2016
First flowering	13/12/2016	16/12/2016	18/12/2016
50% flowering	17/12/2016	19/12/2016	22/12/2016
First fruit	16/12/2016	18/12/2016	20/12/2016
First harvest	23/12/2016	29/12/2016	31/12/2016
Removal of plant	22/2/2017	22/2/2017	22/2/2017

4.4.1 First Flower Bud Formation

Number of days required for first flower bud formation in the crops cultivated in AGH, NAGH and outside for the three crop season are given in Table4.48 and is graphically presented in Fig. 4.109. In the first crop season, first flower bud formation was on 27-12-2015 in AGH which is 13 days after

transplanting. While in NAGH it was on 28-12-15 which is 14 days after transplanting and for open field it was delayed by one more day and was on 29-12-2015. Similar results were obtained for second and third crop also. During all the three crop seasons the flower bud formation was earlier in AGH. During second crop season first flower bud formation was on 12, 14 and 16 days after planting in AGH, NAGH and OGH respectively and for third crop season it was after 13, 16 and 17 days, in AGH, NAGH and OGH respectively.

Table4.48. Number of days required to first flower bud formation

	Number of days to first flower bud formation		
	AGH	NAGH	OGH
First Crop Season	13	14	14
Second crop season	12	14	16
Third crop season	13	16	17

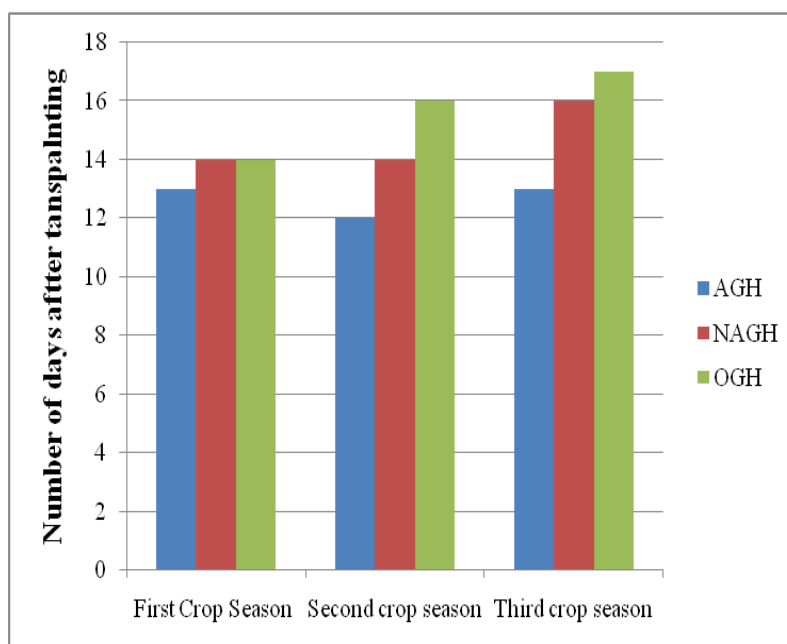

Fig.4.109 Number of days required to first flower bud formation

4.4.2 Number of Days Required to First Flower Formation

Number of days required for first flower formation is given in Table 4.49 and also shown in Fig. 4.110. The crops grown in AGH showed its superior performance in first flowering also. First flowering was on 4-1-15 in AGH and in NAGH it was 7-1-15. First flowering inside AGH was after 21 days after transplanting and in NAGH it was 24 days after transplanting, as it was delayed by 3 days compared to AGH. In second and third crop season the first flowering inside NAGH was delayed by 2 and 3 days respectively compared to AGH.

Table 4.49 Number of days required to first flower formation

	Number of days to first flower		
	AGH	NAGH	OGH
First Crop Season	21	24	26
Second crop season	20	24	27
Third crop season	21	24	26

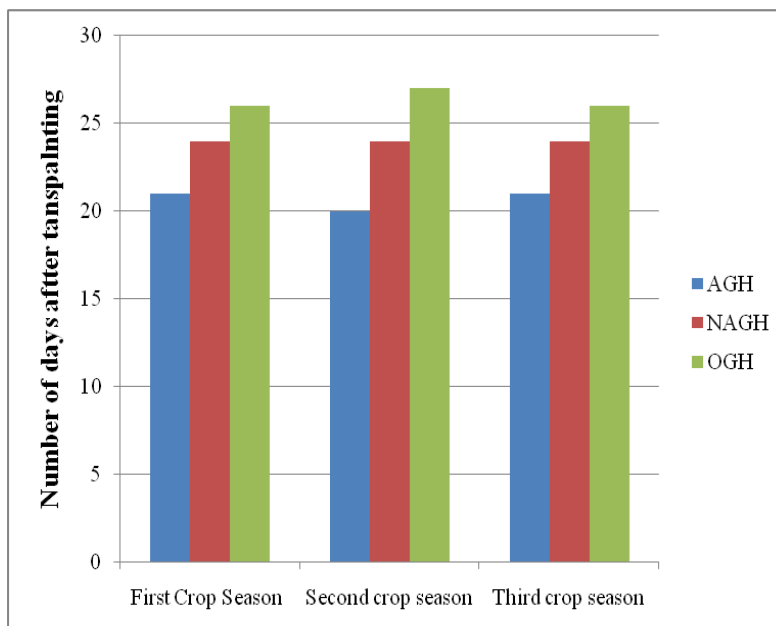

Fig. 4.110 Number of days required to first flower formation

4.4.3 Number of Days Required for 50% Flowering

Number of days required for 50% flowering for crops cultivated inside AGH, NAGH and OGH during all the three crop seasons are given in Table 4.50 and are shown in Fig.4.111. Number of days required for 50 % was 24 days,27 days and 29 days for crops grown inside AGH, NAGH and OGH, respectively during first crop season. Inside the AGH it was on 7-1-2015 and inside NAGH it was on 10-1-2015 which was delayed by 3 days compared to AGH. Flowering was delayed by 4 and 2 days, respectively for second and third crop in NAGH compared to that in AGH.

Table4.50. Number of days required to 50% flowering

	Number of days to 50% flowering		
	AGH	NAGH	OGH
First Crop Season	24	27	29
Second crop season	24	28	30
Third crop season	25	27	30

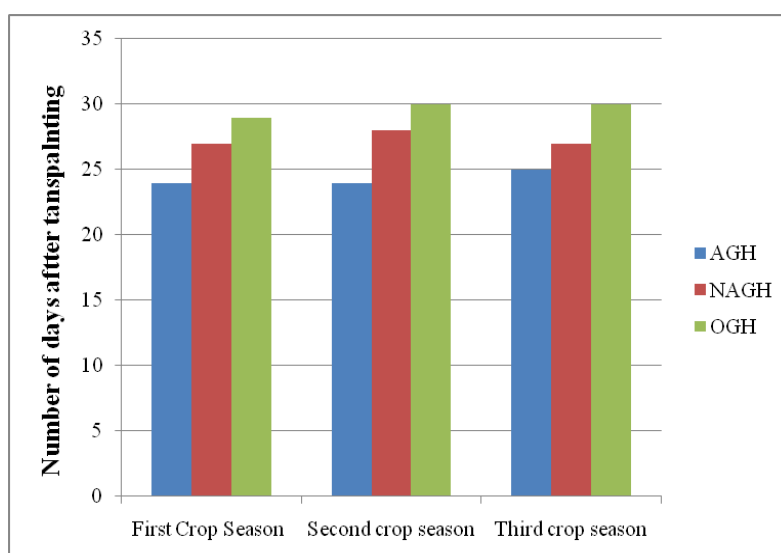

Fig.4.111 Number of days required to 50% flowering

4.4.4 Number of Days Required to First Fruit Set

Number of days required to first fruit set for the crops cultivated inside the AGH, NAGH and OGH are given Table 4.51, which is shown graphically in Fig.4.112. First fruit formation was inside the automated greenhouse and it was delayed by 4 days for crops in NAGH during first crop season. For the second and third crop seasons; it was delayed by 5 and 2 days, respectively. During all the seasons, the crops outside the greenhouse were inferior compared to AGH and NAGH.

Table 4.51 Number of days required to first fruit set

	Number of days to first fruit		
	AGH	NAGH	OGH
First Crop Season	23	27	29
Second crop season	22	27	29
Third crop season	24	26	28

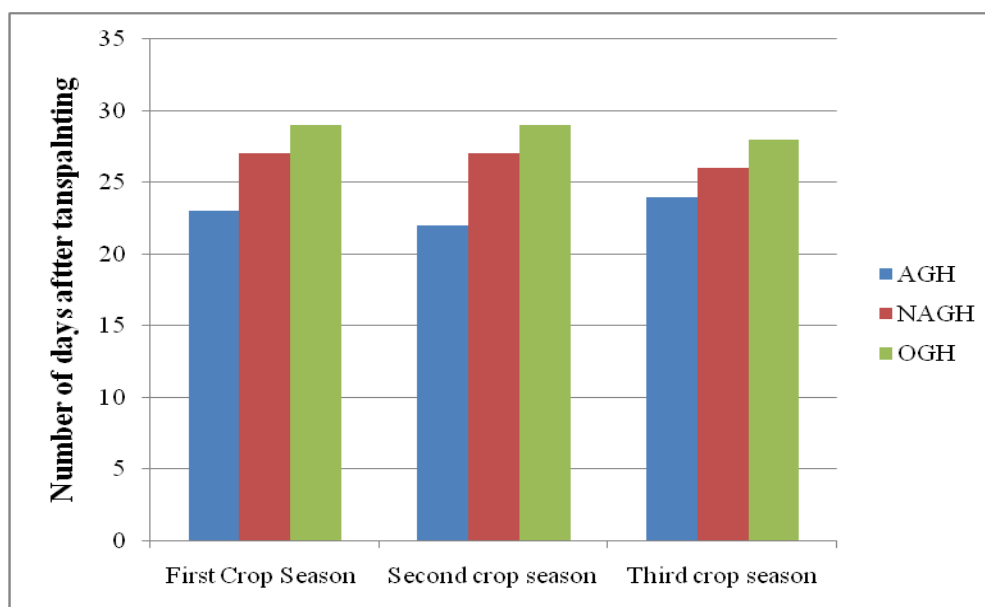

Fig. 4.112 Number of days required to first fruit

4.4.5 Number of Days Required to First Harvest

Numbers of days required to first harvest for the crops cultivated inside the AGH, NAGH and for OGH are given in Table 4.52 and shown graphically in Fig.4.113. During all the three seasons, the first harvest was possible in automated greenhouse. For the first season, the first harvest was done inside the AGH on 32nd day, while in NAGH it was on 36th day and for OGH it was on 38th day. That means first harvest was delayed by 4 days in NAGH and 6 days for crops in OGH. For the second and third seasons the first harvest inside NAGH was delayed by 5 and 6 days, respectively than that of crops in AGH. This clearly showed the advantage of the automated greenhouse compared to non automated greenhouse.

Table4.52 Number of days required to first harvest

	Number of days to first harvest		
	AGH	NAGH	OGH
First Crop Season	32	36	38
Second crop season	30	35	37
Third crop season	31	37	39

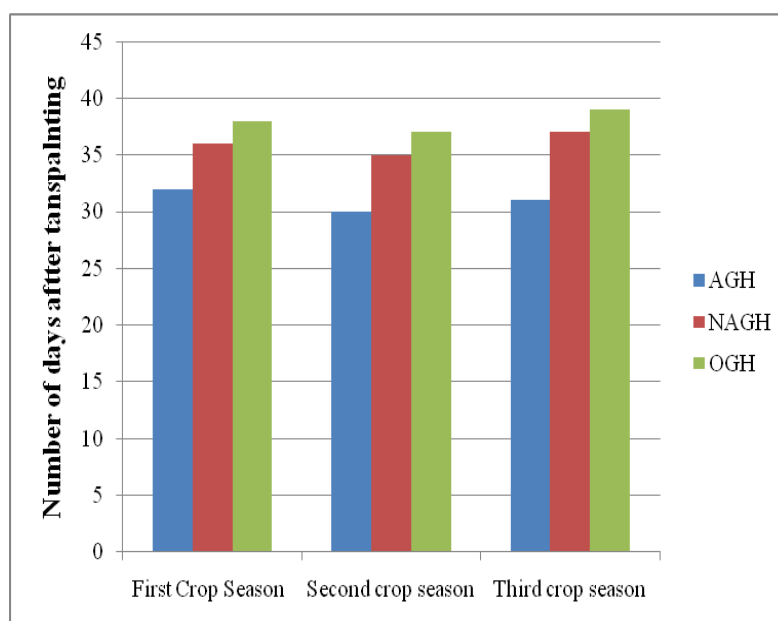

Fig.4.113 Number of days required to first harvest

4.5 ANALYSIS OF BIOMETRIC DATA

Biometric observations were recorded for the crop cultivated inside the automated greenhouse, non automated greenhouse and outside the greenhouse at weekly interval and are presented and analysed below.

4.5.1 Plant Height during Initial Weeks

The average height of plants cultivated inside automated greenhouse, non automated greenhouse and outside the greenhouse during initial four weeks for the three crop seasons are given in Tables 4.53 to 4.55. Comparison of the height of plants is shown in Fig.4.114, Fig.4.115 and Fig.4.116 for first crop, second crop and third crop, respectively. From the graphs it can be seen that during all the four weeks, the height of plant was more for the plants cultivated inside the automated greenhouse. For the first crop, the average plant height was 20.2 cm for automated greenhouse, while it was 19.3 cm for non automated greenhouse and it was only 9.6 cm for the crop cultivated outside the greenhouse. The one way ANOVA test showed that there is no significant difference between AGH and NAGH for plant height but they were significantly different from OGH. For the second crop season average plant height for the crops inside AGH after one week was 20.6 cm and it was 18.2 cm for crops in NAGH and 9.7 cm for crops cultivated OGH. One way ANOVA showed that there is significant difference between the plant height between crops in AGH and NAGH, AGH and OGH and NAGH and OGH. For the third crop also average height of plants was highest in case crops inside AGH compared to NAGH and OGH. The plant height was 20.5 cm for AGH, 17.8 cm for NAGH and 9.3 cm for crops OGH. Statistical analysis showed that there is significant difference between crops inside AGH and NAGH, AGH and OGH and NAGH and OGH.

From the data of plant height during second week for first crop it can be seen that the average height of crops inside the AGH was more than the other two cases. For crops inside AGH it was 79.8 cm while it was 61.9 cm for crops inside NAGH and only 17.3 cm for crops OGH. During the second crop season, the

corresponding heights were 76 cm, 54.4 cm and 14.6 cm respectively and for third crop season it was 79.3 cm, 56.8 cm and 15.9 cm. One way ANOVA showed that there was significant difference between crops in AGH, NAGH and for crops OGH for all the three crop seasons because the ‘p’ value got after the result was less than 0.05. From the graphs and data for the plant height it can be seen that after third and fourth week the height of plant inside the AGH was much more compared to other two cases during all the three crop seasons. The crop height inside the automated greenhouse was greater than that of crop inside NAGH and crops OGH because of the effect of the automation system. In AGH the microclimate was modified within the desirable range of cucumber crop and the irrigation and fertigation was done automatically. The plant height of crop cultivated outside was very less compared to the crops cultivated both inside AGH and NAGH. This was due to the high solar intensity and the low humidity available outside the greenhouse compared to than that within the greenhouse.

Table 4.53 Effect of different treatments on average height of plants for first crop

Treatments	Height of plant (cm) 1st week end*	Height of plant (cm) 2nd week end*	Height of plant (cm) 3rd week end*	Height of plant (cm) 4th week end*
Automated greenhouse	20.2 ^a	79.8 ^a	160.6 ^a	273.4 ^a
Non automated greenhouse	19.3 ^a	61.9 ^b	141.5 ^b	241.1 ^b
Outside the greenhouse	9.6 ^b	17.3 ^c	56.1 ^c	96.2 ^c

*Values followed by same letters are not significantly different at P<0.05

Table 4.54 Effect of different treatment on average height of plants for second crop

Treatments	Height of plant (cm) 1 st week end	Height of plant (cm) 2 nd week end	Height of plant (cm) 3 rd week end	Height of plant (cm) 4 th week end
Automated greenhouse	20.6 ^a	76 ^a	157.2 ^a	252.6 ^a
Non automated greenhouse	18.2 ^b	54.4 ^b	114.3 ^b	207.6 ^b
Outside	9.7 ^c	14.6 ^c	49.4 ^c	97.8 ^c

*Values followed by same letters are not significantly different at P<0.05

Table 4.55 Effect of different treatment on average height of plants for third crop

Treatments	Height of plant (cm) 1 st week end	Height of plant (cm) 2 nd week end	Height of plant (cm) 3 rd week end	Height of plant (cm) 4 th week end
Automated greenhouse	20.5 ^a	79.3 ^a	162.4 ^a	278.7 ^a
Non automated greenhouse	17.8 ^b	56.8 ^b	128.2 ^b	235.4 ^b
Outside	9.3 ^c	15.9 ^c	55.7 ^c	104.7 ^c

*Values followed by same letters are not significantly different at P<0.05

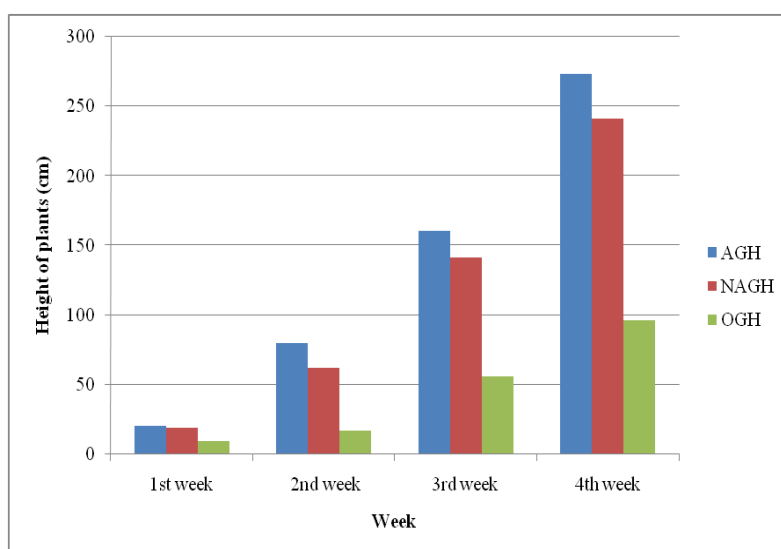

Fig.4.114 Effect of automation on height of plant for first crop

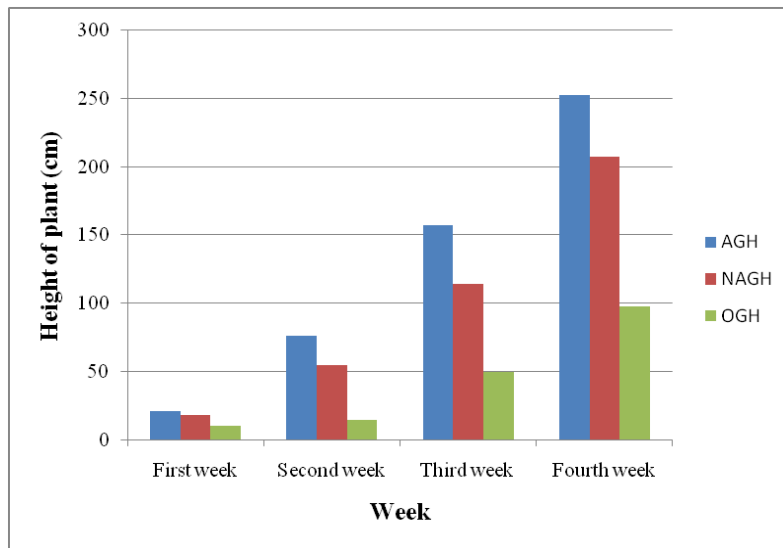

Fig.4.115 Effect of automation on height of plant for second crop

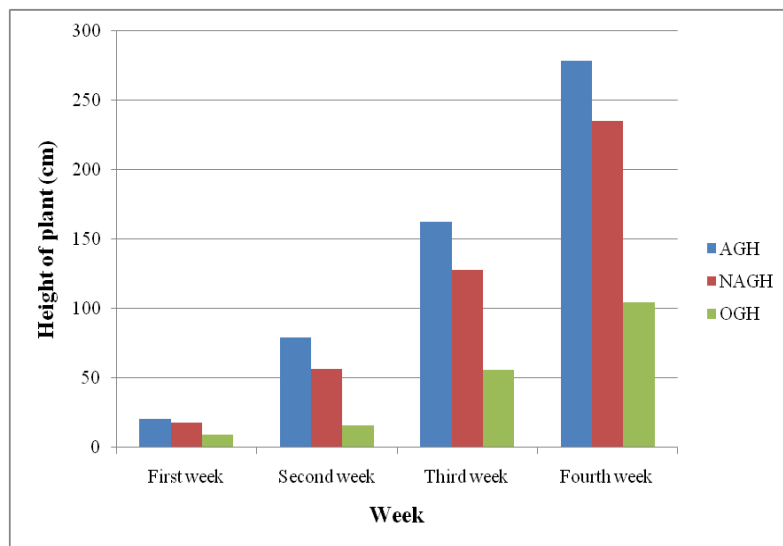

Fig.4.116 Effect of automation on height of plant for third crop

4.5.2 Effect of Treatments on Number of Leaves of Plants

The average of number of leaves of the plants inside the AGH, NAGH and OGH during first, second and third crop season are given in Table 4.56, Table 4.57 and Table 4.58 respectively and shown graphically in Fig.4.117, Fig.4.118 and Fig.4.119 respectively.

Table 4.56 Number of leaves during first crop season

Treatments	First week	Second week	Third week	Fourth week
Automated greenhouse	6.1 ^a	19.8 ^a	35.9 ^a	55.4 ^a
Non automated greenhouse	5 ^b	13.9 ^b	23.5 ^b	37.4 ^b
Outside the greenhouse	4.1 ^c	8.1 ^c	11.9 ^c	19.6 ^c

*Values followed by same letters are not significantly different at P<0.05

Table 4.57 Number of leaves during second crop season

Treatments	First week	Second week	Third week	Fourth week
Automated greenhouse	6.3 ^a	20.3 ^a	35.7 ^a	53.3 ^a
Non automated greenhouse	5.2 ^b	14.5 ^b	24.9 ^b	34.6 ^b
Outside	4 ^c	7.9 ^c	12.9 ^c	19.7 ^c

*Values followed by same letters are not significantly different at P<0.05

Table 4.58 Number of leaves during third crop season

Treatments	First week	Second week	Third week	Fourth week
Automated greenhouse	6.4 ^a	20.9 ^a	36.9 ^a	56.4 ^a
Non automated greenhouse	5.4 ^b	13.1 ^b	23.2 ^b	36.6 ^b
Outside	4.3 ^c	7.5 ^c	12.9 ^c	20.1 ^c

*Values followed by same letters are not significantly different at P<0.05

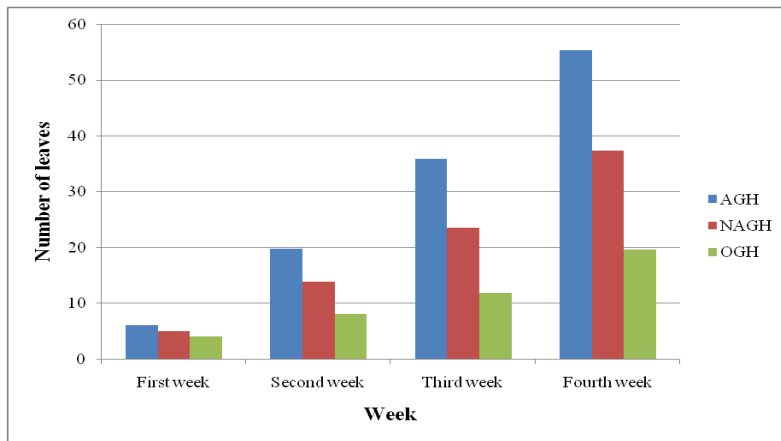

Fig.4.117 Number of leaves during first crop season

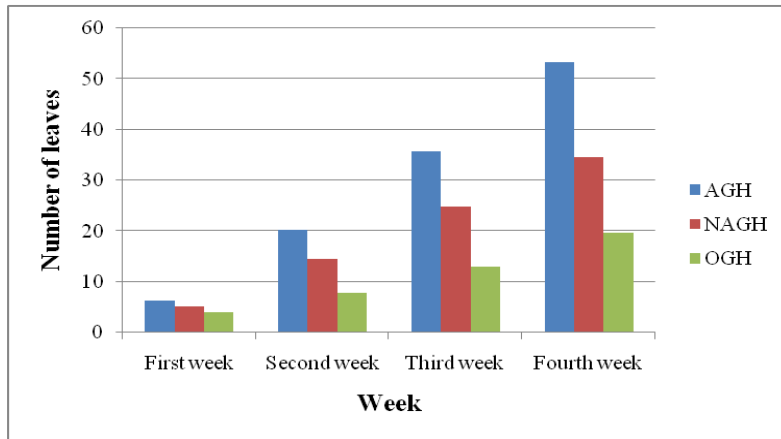

Fig.4.118 Number of leaves during second crop season

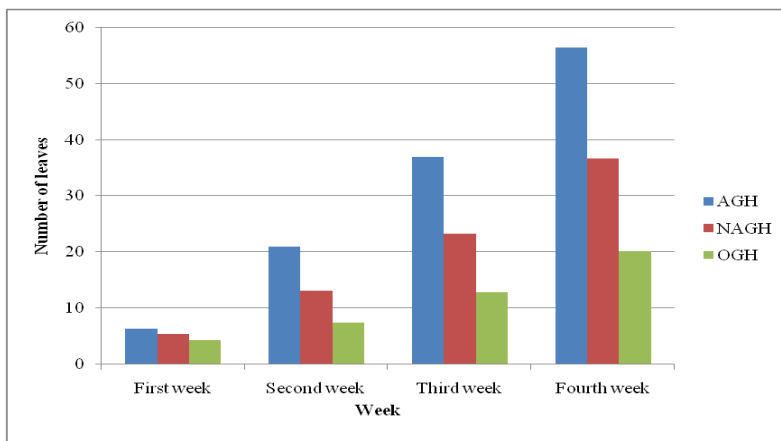

Fig.4.119 Number of leaves during third crop season

From the graphs and tables it is clear that the number leaves was maximum for the crops inside AGH for all the weeks during all the three crop seasons. During first crop season after first week itself the average number of leaves of plants inside AGH was greater than that of plants inside NAGH and OGH. One way ANOVA showed that there was significant difference between number of leaves of plants in side AGH and NAGH and AGH and OGH after first week. After second week the number leaves of plants inside AGH were greater by 5.9 than that of NAGH and by 11.7 than that of OGH. One way ANOVA test resulted that there was significant difference between number of leaves of plants inside the AGH and NAGH and OGH. After third and fourth week also the number of leaves of plants inside AGH was more. The numbers of leaves were highest for crops inside AGH. ANOVA test showed that there was significant difference between number of leaves inside AGH and NAGH after third and fourth weeks.

During second and third crop seasons also the similar observations recorded. The numbers of leaves were highest inside AGH than that of NAGH and OGH. In all the cases maximum number of leaves was inside AGH. One way ANOVA test for all the observations showed that there was significant difference between number of leaves inside AGH and NAGH. This is due to the better microclimate management inside the AGH. The crop growing environment inside AGH was maintained within the desired limit of cucumber. Inside NAGH many times the temperature inside the greenhouse was very high and the RH was very less and because of that the performance of crops inside this greenhouse was poor compared to AGH. The numbers of leaves were least for the crops outside the greenhouse and this was due to the higher solar intensity and less humidity outside the greenhouse. These results proved that automated greenhouses are better than non automated greenhouses.

4.5.3 Effect of Treatments on Leaf Length

Observations on length of leaves were taken at weekly intervals during initial four weeks for the crops inside AGH, NAGH and OGH during all the three crop seasons. The average values of leaf length in AGH, NAGH and OGH are presented in Table 4.59, Table 4.60 and Table 4.61 respectively for first, second and third crop season. These data are shown graphically in Fig. 4.120, Fig.4.121, and Fig.4.122 for the first, second and third crop respectively. From the graphs it can be seen that the length of leaves of plants inside the AGH was more than that of NAGH and OGH for all the weeks during all the crop seasons. After first week itself there was notable difference in leaf length between plants inside AGH and other two treatments. One way ANOVA test done for all the observations and found that there was significant difference between leaf length of plants in AGH and NAGH and OGH. Greater length of leaves inside the greenhouse during initial weeks was because of the automation system inside the greenhouse. In AGH the environment was within the desirable range of cucumber crop. But in NAGH temperature was higher the limit and RH was lower than the requirement of crop. This result proves the advantage of automation system. The worst performance of crops outside the greenhouse was due to higher solar intensity and lower values of relative humidity during peak hours of the day.

Table 4.59 Effect of treatments on leaf length (cm) during first crop season

Treatments	First week	Second week	Third week	Fourth week
Automated greenhouse	11.2 ^a	18.5 ^a	20.5 ^a	21.1 ^a
Non automated greenhouse	7.7 ^b	10.9 ^b	15.1 ^b	18.2 ^b
Outside the greenhouse	6.5 ^c	9.9 ^c	12.1 ^c	14.2 ^c

*Values followed by same letters are not significantly different at $P < 0.05$

Table 4.60 Effect of treatments on leaf length (cm) during second crop season

Treatments	First week	Second week	Third week	Fourth week
Automated greenhouse	10.7 ^a	18 ^a	20.2 ^a	21.9 ^a
Non automated greenhouse	7.5 ^b	11.7 ^b	15.1 ^b	18.7 ^b
Outside the greenhouse	6.2 ^c	8.8 ^c	12.4 ^c	15.5 ^c

*Values followed by same letters are not significantly different at P<0.05

Table 4.61 Effect of treatments on leaf length (cm) during third crop season

Treatments	First week	Second week	Third week	Fourth week
Automated greenhouse	11.1 ^a	18.8 ^a	20.3 ^a	21.4 ^a
Non automated greenhouse	7.4 ^b	10.8 ^b	14.7 ^b	18.7 ^b
Outside the greenhouse	6.3 ^c	9.6 ^c	11.9 ^c	15.3 ^c

*Values followed by same letters are not significantly different at P<0.05

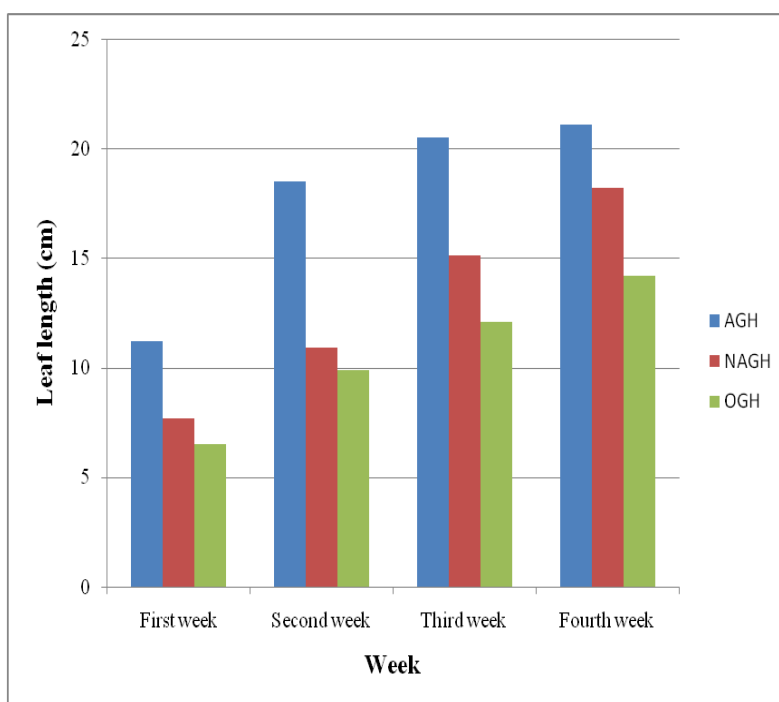

Fig 4.120 Effect of treatments on leaf length (cm) during first crop season

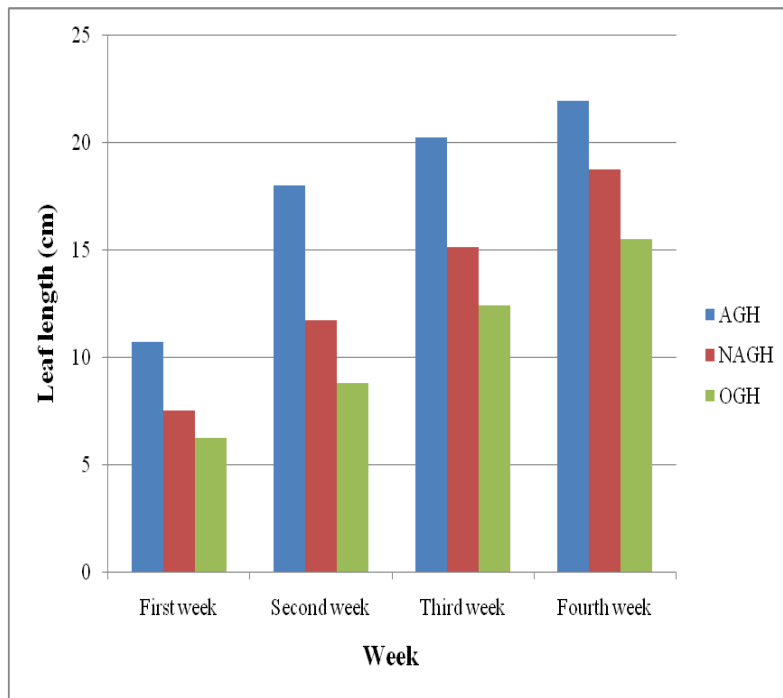

Fig. 4.121 Effect of treatments on leaf length (cm) during second crop season

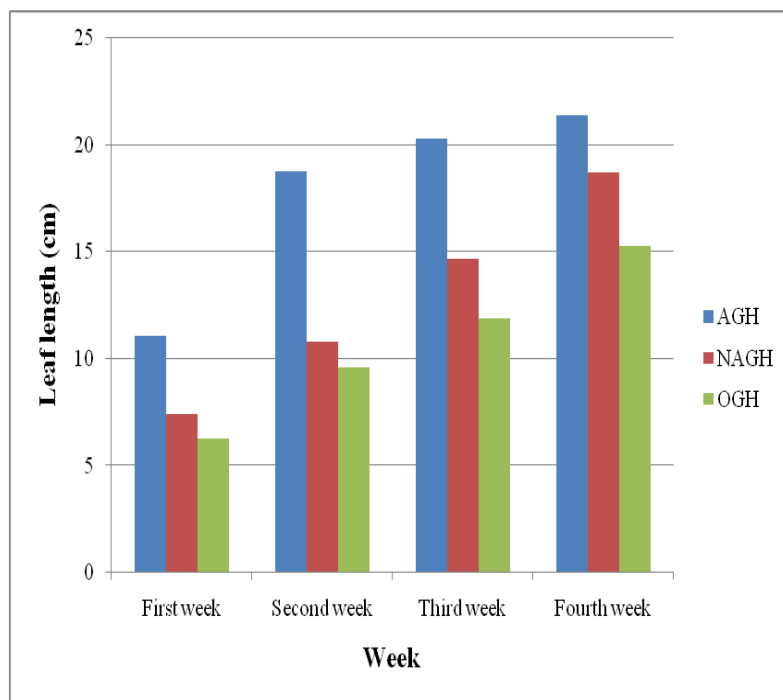

Fig. 4.122 Effect of treatments on leaf length (cm) during third crop season

4.5.4 Effect of Treatments on Leaf Width during Initial Weeks

Effect of different treatments on leaf width was tested by taking weekly observations of leaf width of selected plants inside AGH, NAGH and OGH during all crop seasons. The average values of leaf width of selected plants for AGH, NAGH and OGH are given Table 4.62, Table 4.63 and Table 4.64 for the first, second and third season respectively. These data are graphically shown in Fig. 4.123 Fig. 4.124 and Fig.4.125 for first, second and third crop seasons respectively. From the graphs and tables it is evident that the leaf width of crops inside the AGH was greater than that of NAGH and OGH for all observations during all the seasons. Statistical test using one way ANOVA showed that there was significant difference between leaf width of plants in AGH and NAGH and OGH. Greater leaf width of plants inside the AGH compared to other two treatments is due to the effect of automation system. It managed the greenhouse microclimate within the desirable limit of cucumber crop. This result proved the necessity of automation system in greenhouses.

Table 4.62 Effect of treatments on leaf width (cm) during first crop season

Treatments	First week	Second week	Third week	Fourth week
Automated greenhouse	12 ^a	20.6 ^a	24.1 ^a	24.4 ^a
Non automated greenhouse	8.3 ^b	12.4 ^b	16.2 ^b	20.4 ^b
Outside the greenhouse	7.2 ^c	10.9 ^c	13.9 ^c	16.7 ^c

*Values followed by same letters are not significantly different at P<0.05

Table 4.63 Effect of treatments on leaf width (cm) during second crop season

Treatments	First week	Second week	Third week	Fourth week
Automated greenhouse	11.4 ^a	19.9 ^a	23.9 ^a	24.9 ^a
Non automated greenhouse	8.4 ^b	13.4 ^b	17.1 ^b	21 ^b
Outside the greenhouse	6.9 ^c	10.1 ^c	14.4 ^c	17.9 ^c

*Values followed by same letters are not significantly different at P<0.05

Table 4.64 Effect of treatments on leaf width (cm) during third crop season

Treatments	First week	Second week	Third week	Fourth week
Automated greenhouse	11.8 ^a	20.7 ^a	23.8 ^a	24.6 ^a
Non automated greenhouse	8.1 ^b	12.2 ^b	16.4 ^b	20.8 ^b
Outside the greenhouse	7 ^c	10.8 ^c	13.8 ^c	17.1 ^c

*Values followed by same letters are not significantly different at P<0.05

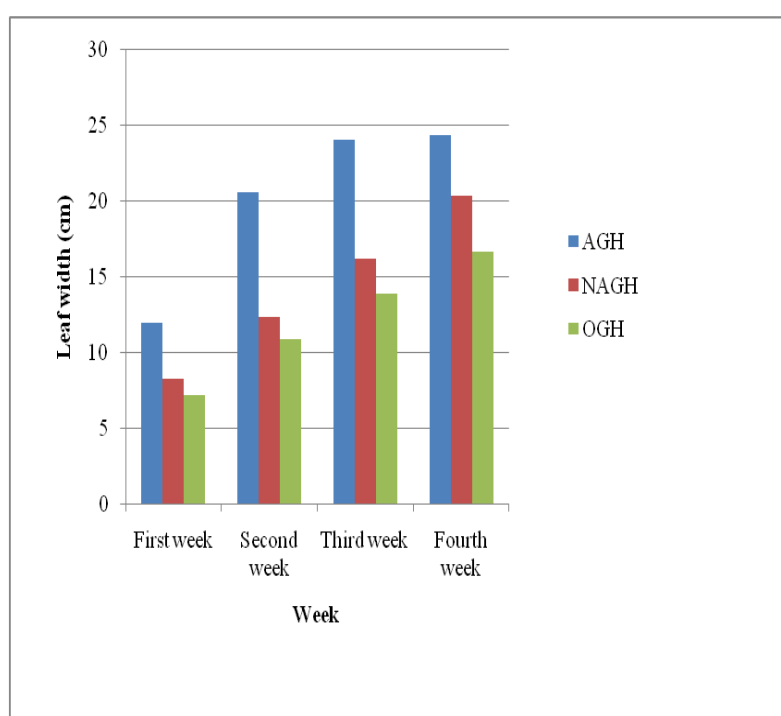

Fig. 4.123 Effect of treatments on leaf width (cm) during first crop season

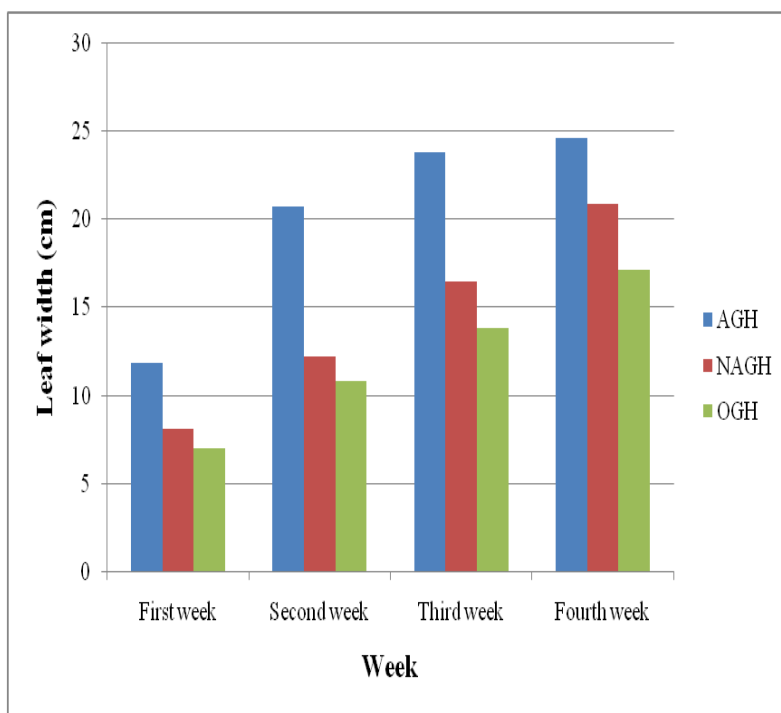

Fig. 4.124 Effect of treatments on leaf width (cm) during second crop season

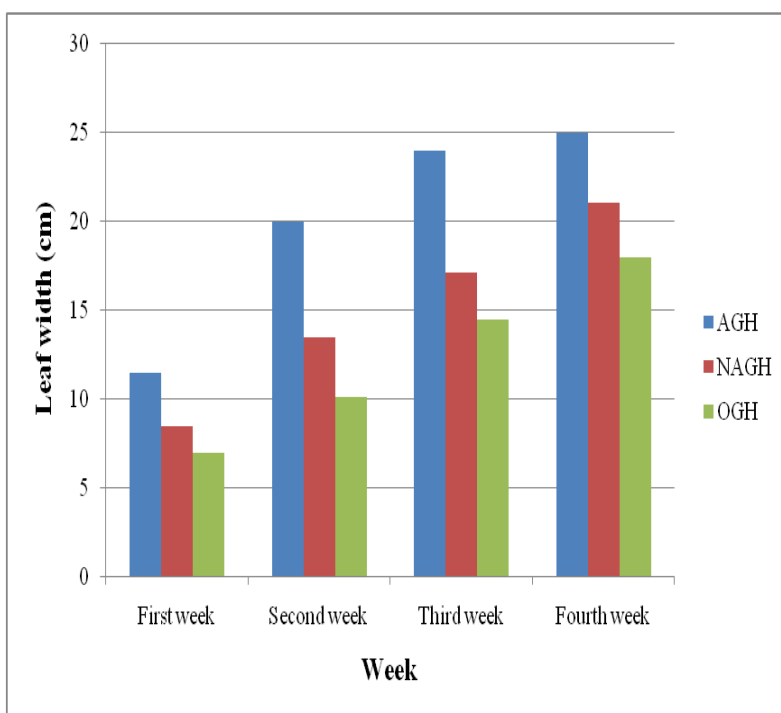

Fig. 4.125 Effect of treatments on leaf width (cm) during third crop season

4.6 EFFECT OF AUTOMATION ON YIELD OF PLANTS

4.6.1 Total Yield from Plant

The average of the total yield from the selected plants for entire crop seasons during three crop seasons are given in Table 4.65 and it is compared in Fig. 4.126. From the graph and Table it is evident that maximum yield was obtained from crops inside the AGH than NAGH and OGH. During first crop season average yield per plant from crops in AGH is 7.89 kg which is 5.74 kg more than that of crops in NAGH and 6.9 kg more than that of crops outside the greenhouse. Statistical analysis of one way ANOVA showed that the 'p' value obtained after test is less than 0.05 and hence there is significant difference between yield from crops in AGH than that of NAGH and OGH. These results are in agreement with the earlier reports by researchers such as Ehret *et al.* (2011), Dondapadi and Rajlu (2012), Salleh *et al.*(2013) and Neto *et al.* (2014). Automation study in drip irrigation conducted previously by Navaneeth Sharma (2014) and Sunny and Hakkim (2017) also reported that automation gives maximum yield.

During second crop season, there was no much difference between yield of crops from AGH and NAGH. In AGH the yield per plant was 4.42kg while it was 4.54 kg in case NAGH and 0.99 for crops OGH. Even though there was no much difference between yields of crops from AGH and NAGH, yield from plants of NAGH was 0.12 kg greater than that of AGH. Yield per plant of crops from OGH was very low compared to that of AGH and NAGH. Second crop was cultivated during the months of May, June and July. Out of which June and July falls in rainy season and during these months no climate control measures were needed inside both the greenhouses. That is why there was not much difference in yield of AGH and NAGH. One way ANOVA showed that there is no significant difference of yields between AGH and NAGH. But there was significant difference between AGH and OGH and NAGH and OGH. It can also be noted

that the yield from NAGH and OGH was less than the yield from AGH during first crop season. This can be because of lesser solar intensity inside the greenhouse. During the first season, when the solar intensity was more the microclimate was automatically modified inside the greenhouse, the yield from AGH was 7.89 kg plant⁻¹ but this time it was 4.42 kg plant⁻¹. For outside crop also the yield was less during this season.

During third crop season, the yield from AGH was 7.18kg/plant while in NAGH it was 2.16 kg plant⁻¹ and for crops OGH it was 0.91 kg plant⁻¹. This yield was similar to that of first season. Yield/plant from AGH was 5.02 kg greater than that of NAGH and 6.27 kg greater than OGH. This is due to the automation system inside the greenhouse as in automated greenhouse the microclimate was modified by using the automation system.

Table 4.65 Effect of treatments on yield of cucumber

	Total Yield (kg Plant ⁻¹)		
	First crop	Second crop	Third crop
AGH	7.89 ^a	4.42 ^a	7.18 ^c
NAGH	2.15 ^b	4.54 ^a	2.16 ^b
OGH	0.99 ^c	0.75 ^b	0.91 ^c

*Values followed by same letters are not significantly different at P<0.05

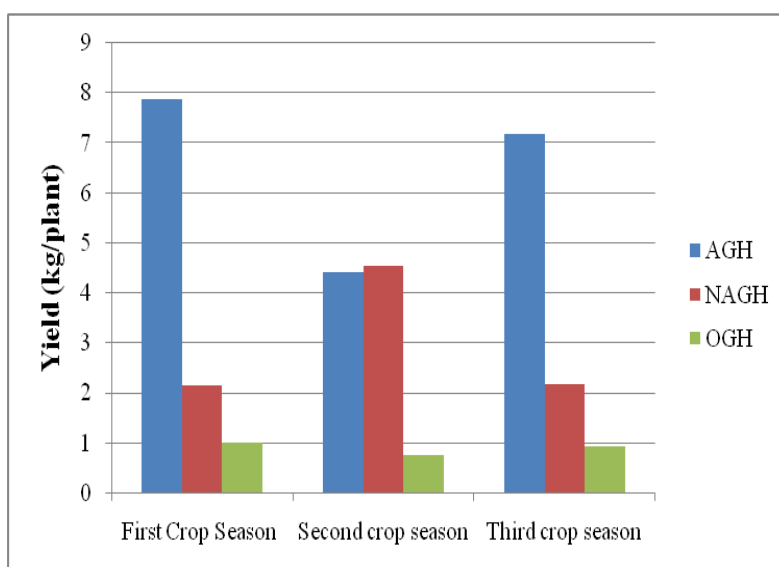

Fig4.126 Effect of treatments on yield of cucumber

4.6.2 Average length of fruits.

The average length of fruits of selected plants from AGH, NAGH and plants outside the greenhouse are given in Table 4.66 and are compared graphically in Fig.4.127. From the figure and table and it is evident that the average length of fruits is maximum in case of plants grown inside AGH compared to other treatments. During first crop season average length of fruit was 21.4 cm inside AGH while in NAGH it was 18.6 cm and for OGH it was only 15 cm. Length of fruits from AGH was 2.8 cm greater than that of NAGH and 6.4 cm greater than that of OGH. One way ANOVA showed that there is significant difference between fruit lengths between AGH and NAGH and AGH and OGH.

During second season average length fruits were 20.7 cm, 20.6 cm and 13.4 cm for crops grown inside AGH, NAGH and OGH respectively. Here the lengths of fruits were almost same for AGH and NAGH. This is because during June and July there was no modification of microclimate inside the greenhouse. Microclimate conditions inside both the greenhouses were same for this season. So lengths of fruits were also same. The average lengths of fruits of crops outside the greenhouse were lesser than that from the greenhouse. This was because of

the microclimate inside the greenhouse is better for cucumber production than that of outside. One way ANOVA showed that there was no significant difference between length of fruits between AGH and NAGH.

Average lengths of fruits during third crop season were 21.3 cm, 18.5 cm and 13.6 cm for plants in AGH, NAGH and OGH respectively. From the graph it is clear that the length of fruits were more for plants inside the AGH. Length of fruits in AGH was 2.8 cm greater than that of NAGH and 7.7 cm greater than that of crops outside the greenhouse. Above results showed that automatic microclimate control inside the greenhouse is better for crops inside the greenhouse. The poor performance of crops outside the greenhouse was due to higher solar intensity and because of the lowest relative humidity. One way ANOVA test showed that there is significant difference between crops in AGH and NAGH and AGH and OGH.

Table 4.66 Effect of treatments on average length of fruits

	Average length of fruit (cm)		
	First crop	Second crop	Third crop
AGH	21.4 ^a	20.7 ^a	21.3 ^a
NAGH	18.6 ^b	20.6 ^a	18.5 ^b
OGH	15 ^c	13.4 ^b	13.6 ^c

*Values followed by same letters are not significantly different at P<0.05

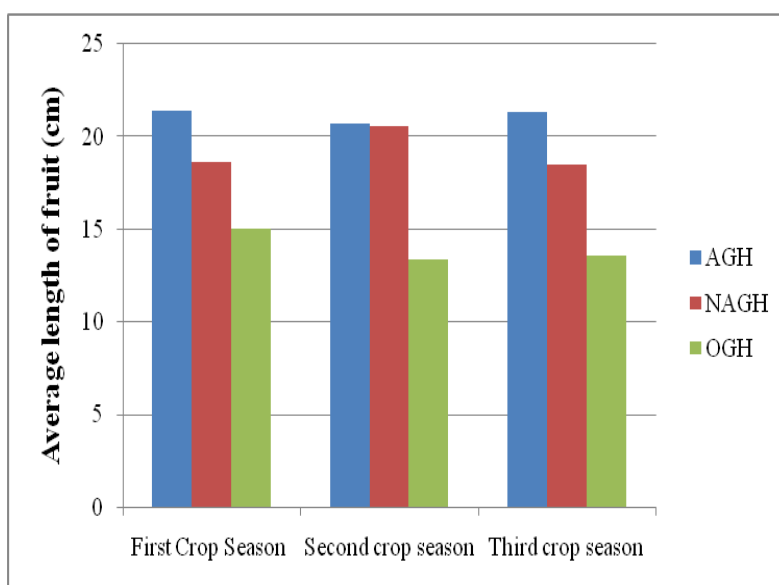

Fig.4.127 Effect of treatments on average length of fruits

4.6.3 Average Diameter of Fruit

Average diameters of fruits from AGH, NAGH and from OGH during the three seasons are given in Table 4.67 and the data is compared in Fig.4.128. From the figure it is clear that average diameters of fruits were more for the crops inside the AGH during first and third crop season and during second season the diameters were same for AGH and NAGH. During first and third season automatic microclimate management was done inside AGH. During second season there was no microclimate modification done during two of the three months of crop period. That is why the diameters of fruits from AGH and NAGH were same for that season. This proves that when the microclimatic parameters are higher than the upper limit of the requirement of crops, modification is required and automatic microclimate management can give better results.

Average diameter of fruits during first crop season was 5.2 cm, 4 cm and 3.2 cm for AGH, NAGH and OGH respectively. Diameter of fruits from AGH is 1.2 cm greater compared to NAGH and 2 cm compared to plants OGH. Higher diameter of fruits in AGH is due to the better maintenance of required

microclimate inside the AGH through automation system. One way ANOVA test showed that there is significant difference between the diameter fruits between AGH and NAGH and AGH and OGH because p value got was less than 0.05.

During second crop season the average diameters of fruits from both AGH and NAGH were 4.6 cm and for OGH it was 3.2 cm. Second trial was conducted during the months of May, June and July and out of which June and July falls in rainy season and at that time temperature inside the greenhouse was within temperature requirement of crop without any cooling method. So in both the greenhouse fans and foggers were not operated. One way ANOVA test showed that there is no significant difference between fruit diameter between crops from AGH and NAGH.

During third crop season the average diameter of fruits in AGH, NAGH and OGH were 5 cm, 3.9 cm and 3.1 cm respectively. Average diameter of plants in AGH was 1.1 cm greater than that of NAGH and 1.9 cm than OGH. Because of the automation system, the microclimate inside the greenhouse was maintained within the range of cucumber crop and hence its fruits got maximum diameter than that of crops in NAGH and OGH. One way ANOVA test showed that there was significant difference between diameter of fruits from AGH and NAGH and OGH.

Table 4.67 Effect of treatments on average diameter of fruit

	Average diameter of fruit (cm)		
	First crop	Second crop	Third crop
AGH	5.2 ^a	4.6 ^a	5 ^a
NAGH	4 ^b	4.6 ^a	3.9 ^b
OGH	3.2 ^c	3.2 ^b	3.1 ^c

*Values followed by same letters are not significantly different at P<0.05

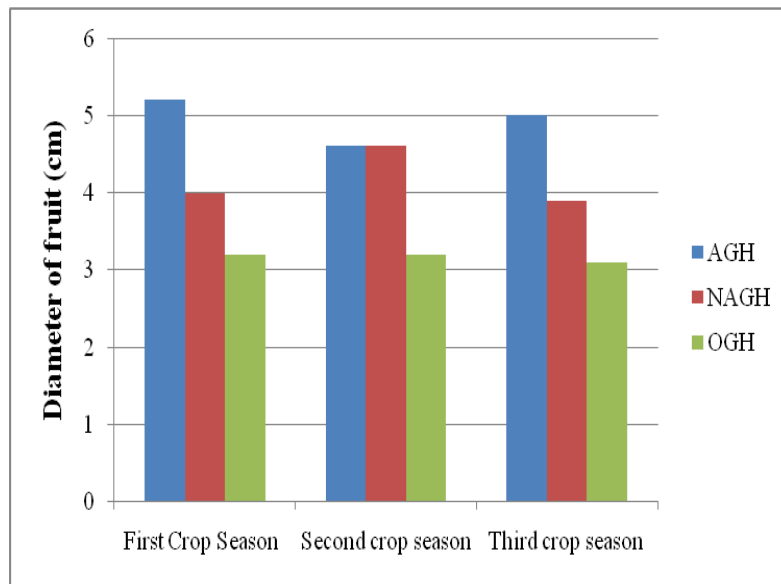

Fig.4.128 Effect of treatments on average diameter (cm) of fruit

4.6.4 Average Weight of the Fruit

Average weights of fruits from AGH, NAGH and from OGH during the three seasons are given in Table 4.68 and are compared in Fig. 4.129. From the figure it can be seen that average weight of single fruit is highest for AGH during first and third crop seasons. During second crop season the weight of fruits were almost same. This was because during second crop season for the later two months i.e. June and July there was no need of any cooling system and hence the microclimate inside both the greenhouses was almost same. For the other two seasons temperature inside the greenhouse were above the range of crops during peak hours of the day and at that time automation system successfully reduced the greenhouse temperature to the optimum limit and hence the weight of fruits is higher for AGH.

During first crop season the average weight of fruits from AGH was 260.69 g while it was 207.59 g for NAGH and 149.27 g for OGH. Weight of fruits from AGH was 53.1 g higher than that of NAGH and 111.42 g than that of

OGH. One way ANOVA showed that there was significant difference between weight of fruits from AGH and NAGH and OGH.

The average weight of fruits from AGH, NAGH and OGH were 213.3 g, 209.5 g and 137.7 g respectively during second crop season. Even though the weight of fruits from AGH was slightly higher than NAGH, one way ANOVA showed that there was no significant difference between these two. And average values were almost same. The average weight of fruit is less than that of first and third seasons. The reason is that during fruiting stage (June and July) the solar intensity was less and hence the weight of fruit also was less in this case compared to other two seasons.

The average weights of fruits during third crop season were 25.26 g, 193.04 g and 139.49 g respectively. Weight of fruits from AGH was 59.22 g higher than that of NAGH and 112.77 g than that of OGH. Highest weight of fruits in AGH was due to the better microclimate management inside the AGH by automation system. One way ANOVA showed that there was significant difference between weight of fruits from AGH and NAGH and OGH.

Table 4.68 Effect of treatments on average weight of fruit

	Average weight of fruit (g)		
	First crop	Second crop	Third crop
AGH	260.69 ^a	213.3 ^a	252.26 ^a
NAGH	207.59 ^b	209.5 ^a	193.04 ^b
OGH	149.27 ^c	137.7 ^b	139.49 ^c

*Values followed by same letters are not significantly different at P<0.05

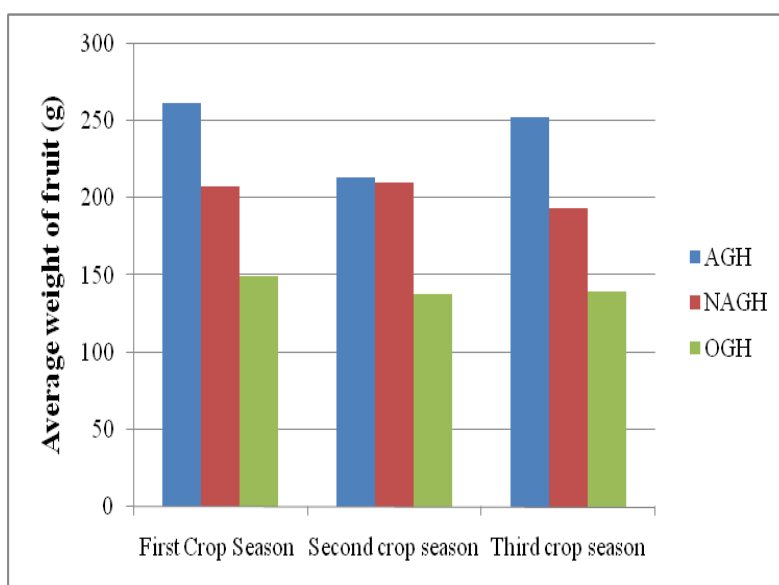

Fig.4.129 Effect of treatments on average weight of fruit

4.6.5 Number of Fruits per Plant

Harvesting of the cucumber was done from the selected plants and the total number of fruits from AGH, NAGH and OGH were recorded. Average of the total number of fruits from AGH, NAGH and OGH are presented in Table 4.69 and shown graphically in Fig. 4.130. From the figure it is evident that the number of fruits per plant from AGH was more during first and third crop seasons and during second crop season the number of fruits per plant from AGH and NAGH were almost same. Number of fruits per plant was minimum in case of open field. This is because inside the greenhouse the microclimate was better than open field.

During first crop season number of fruits per plant from AGH was more compared to that of NAGH and OGH. Average number of fruits from AGH and NAGH and OGH were 31.57, 10.36 and 6.64 respectively. Number of fruits per plant from AGH was greater by 21.21 than that of NAGH and 24.93 than that of OGH. Higher yield from AGH was because of the automation system. One way ANOVA showed that there was significant difference between number of fruits per plant from AGH and NAGH and OGH.

The average number of fruits per plant from AGH, NAGH and OGH were 20.64, 21.64 and 5.43 respectively during second crop season. During this season number fruits from NAGH was slightly higher than that of AGH, but one way ANOVA showed that there was no significant difference between number of fruits per plant from AGH and NAGH because the ‘p’ value obtained after the test was greater than 0.05. The crop was cultivated during the months of May, June and July for second season. Out of which during June and July no microclimate modification was required in both greenhouses and hence the yield parameters were almost same during second season.

During third season, the number of fruits from plant was 28.5 for AGH, 11.29 for NAGH and 6.5 for OGH respectively. Number of fruits per plant was highest for AGH compared to NAGH and OGH. This was because of the automation system installed inside the greenhouse. The microclimate was modified within the range of cucumber crop. In NAGH and OGH the temperature and relative humidity were outside the desirable range and because of that the yield parameters were lesser than that of AGH. Number of fruits per plant from AGH was greater by 17.21 than that of NAGH and by 22 than that of OGH. One way ANOVA test showed that there was significant difference between number of fruits per plant from AGH and NAGH and OGH. All these results showed that automated greenhouses are better than non automated greenhouses.

Table 4.69 Effect of treatments on average of number of fruits per plant

	Average of Number of fruits per plant		
	First crop	Second crop	Third crop
AGH	31.57 ^a	20.64 ^a	28.5 ^a
NAGH	10.36 ^b	21.64 ^a	11.29 ^b
OGH	6.64 ^c	5.43 ^b	6.5 ^c

*Values followed by same letters are not significantly different at P<0.05

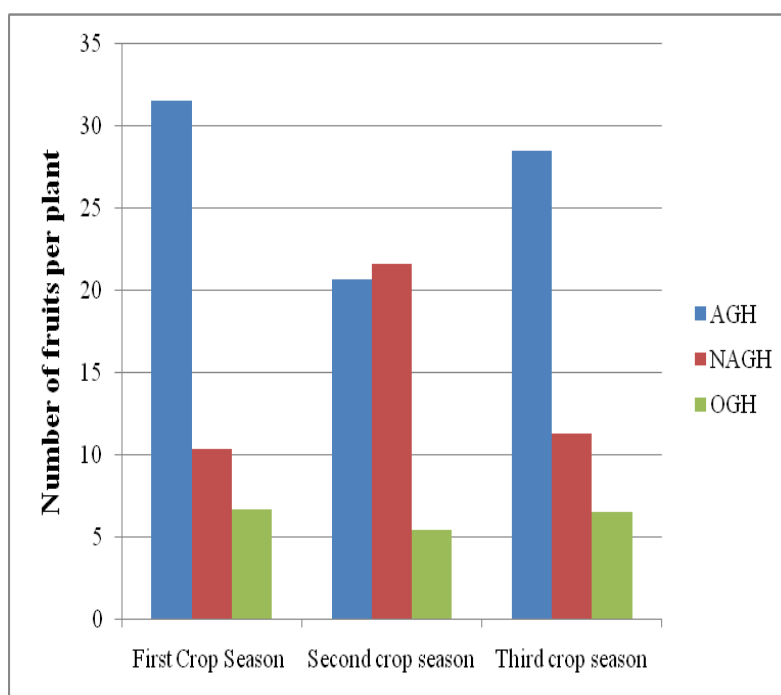

Fig. 4.130 Effect of treatments on number of fruits per plant

4.7 COST ANALYSIS

Comparison of cost of cultivation inside the automated greenhouse and non-automated greenhouse is given in Table 4.70. Net return or profit and cost benefit ratio for both greenhouses were worked out. Cost of cultivation of three crops inside AGH during one year was Rs.116000/- whereas inside NAGH it was Rs. 100700/-. Profit from automated greenhouse was Rs.156860/- and that from non-automated greenhouse was only Rs.16900/-. The profit from AGH was greater when compared to NAGH and hence the cost benefit ratio was also high in case of AGH (2.35) when compared to NAGH (1.16). This is because of the higher yield obtained from AGH as a result of performance of the automation system when compared with the non-automated greenhouse.

Table 4.70 Comparison of cost of cultivation

Sl.No	Items	Automated Greenhouse	Non Automated Greenhouse
I	Fixed Cost		
A	Cost of greenhouse	Rs. 400000	Rs. 400000
	Life period	10 years	10 years
1	Depreciation @ 10 per cent	Rs. 40000	Rs. 40000
2	Interest @ 7 per cent	Rs. 28000	Rs. 28000
B	Cost of automation system	Rs.50000	0
3	Life period	10 years	0
4	Depreciation @10 per cent	Rs. 5000	0
5	Interest @ 8 per cent	Rs. 4000	0
II	Variable cost		
6	Repairs and maintenance	Rs.5000	Rs.1000
7	Electricity cost	Rs.12000	Rs.3500
8	Labour cost of operation of actuators	Rs. 6000	Rs. 13500
9	Total cost per year (1+2+4+5+6+7+8)	Rs. 100000	Rs. 86000
10	Cost of cultivation for cucumber	Rs. 18000	Rs. 18000
11	Total cost of cultivation (9+10)	Rs. 118000	Rs. 104000
12	Gross return / income	Rs. 272860	Rs. 123900
13	Profit (12-11)	Rs. 154860	Rs. 19900
14	Benefit-Cost ratio (12/11)	2.3	1.2

CHAPTER V

SUMMARY

Microclimate management inside the greenhouse is to be done depending upon the crop grown inside it and this can be achieved either manually or automatically. The present study entitled “Evaluation and refinement of low cost automation system for naturally ventilated greenhouses” was carried out during the period from July 2015 to February 2017 to modify the existing low cost greenhouse automation system developed at ARS Anakkayam and to carry out its performance evaluation. Existing automation system had limitations such as it could not manage temperature and relative humidity separately and also could not manage irrigation and fertigation. The above problems were rectified in the refined automation system. Refinement of the system was done by changing the microcontroller used in the automation system and also by incorporating a timer for the timely management of irrigation and fertigation. The refined system was capable of managing temperature and relative humidity separately and performing irrigation and fertigation operations inside the greenhouse. The refined automation system was tested without crop and thereafter with crop during three crop seasons by growing salad cucumber crop (variety Saniya) inside the greenhouse. The experiment was conducted inside a naturally ventilated greenhouse situated at the ARS, Anakkayam, under Kerala Agricultural University. For comparison, same crop was cultivated inside another greenhouse which is manually controlled. Microclimate as well as crop data were collected both from outside the greenhouse and from inside of both these greenhouses and were compared.

The refined automation system was capable for intelligent control of temperature and relative humidity inside the greenhouse. Whenever the inside temperature exceeds 37 °C and relative humidity falls to less than or equal to 65% then the controller of the automation system switches on the fans and foggers to reduce the temperature. Foggers and fans will be operated until the temperature becomes 33 °C or until the RH exceeds 70%. When the temperature is above 37

$^{\circ}\text{C}$ and RH is above 70%, then the fans alone will work until the RH falls below 65%, thereafter both foggers and fans will be operated to reduce the temperature. Thus the temperature inside the greenhouse can be managed without increase of RH beyond the set point.

The microclimate data such as temperature, relative humidity and light intensity were recorded from both automated greenhouse and non-automated greenhouse and outside the greenhouse at 1 hour interval from 10 am to 5 pm. Crop data such as biometric observations and yield parameters were collected. Weekly biometric observations such as plant height, number of leaves per plant, leaf length and leaf width were noted from the randomly selected plants for the initial four weeks during the three crop season. Important events such as date of transplanting, date of formation of first flower bud, date of development of first flower, date on which 50% flowering occurred, date of first fruit formation, date of first harvest were noted in both the greenhouses during the three crop seasons. Yield data such as total yield from the plant, average fruit diameter, average fruit length, average fruit weight and numbers of fruits from individual plants were recorded from the randomly selected plants.

From the microclimate data recorder between 10 am to 5 pm, it was observed that mean temperature inside AGH was 3.3°C less compared to NAGH. Mean temperature inside AGH from 10 am to 5 pm was 36.2°C , whereas in NAGH it was 39.5°C . There was significant difference between temperature in AGH and NAGH. During second crop season average temperature inside AGH was 34.4°C and in NAGH it was 35.7°C . Inside AGH temperature was 1.3°C less than that of NAGH. Even though these values are numerically different there was no significant difference between temperature in AGH and NAGH. This was due to the reason that second crop was cultivated during months of May, June and July 2016 and due to heavy rainfall, the temperature inside the greenhouses were less than 36°C . Hence cooling system was not operated in both the greenhouses from second week of June onwards. Temperature inside both the greenhouses

were almost same during that period. Hence there was no significant difference between temperature inside AGH and NAGH. During 3rd crop season mean temperature inside AGH was 35.7 °C and inside NAGH it was 38.8 °C. Temperature inside AGH was 3.1 °C lesser than NAGH. There was significant difference between temperature in AGH and NAGH. Light intensity inside both greenhouses were almost same during all the three crop seasons.

Relative humidity outside the greenhouse from 10 am to 5 pm was less than that inside the greenhouse. During peak hours of the day RH was reduced below 30%. At that time RH inside NAGH was reduced below 35% and inside AGH, RH was maintained above 50% and below 70%. Mean RH inside AGH from 10 am to 5 pm during 1st crop season was 63.1% and in NAGH it was 40.6%. RH inside AGH was 22.5% higher when compared to NAGH. During second crop season mean RH inside AGH was 65.8% and inside NAGH it was 58.3%. RH inside AGH was 7.8% higher than that inside the NAGH. Compared to other two seasons, the difference in RH between AGH and NAGH were less during the second crop season. Mean RH in AGH during 3rd crop season was 65% and inside NAGH it was 44.8%. That means RH in AGH was 20.2% greater than NAGH. There was significant difference between RH in AGH and NAGH during all the three crop seasons.

From the microclimate data it was noted that automation system activated the foggers and fans according to the pre-set points. Temperature inside the AGH was lesser than that in NAGH and RH inside the AGH never exceeded 70%. During some of the hottest weeks, temperature inside AGH exceeded above the maximum set point of 37 °C because of time lag of 5 minutes set in the microcontroller and also due to that the maximum RH of 70% was set in the microcontroller. Compared to NAGH, temperature inside AGH was less and the RH was maintained between 50% and 70%. From the above, it could be concluded that the refined automation system is capable of managing temperature

and relative humidity inside the greenhouse and crop performance under automatic microclimate control is better than manual control.

The refined automation system was capable of performing the irrigation and fertigation based on the pre-set conditions. Fertigation was given once in three days and irrigation was given four times in a day. The yield parameters and biometric observations were best inside the automated greenhouse compared to the non automated greenhouse. Hence from the crop data it was observed that irrigation and fertigation automation system was capable of performing its functions.

From the observation, it was found that date of first flower bud formation, date of first flowering, date of 50% flowering, date of first fruit setting and first harvest occurred early in AGH than NAGH during all the three seasons. From biometric observation, it was found that height of plant, number of leaves per plant, leaf length and leaf width were higher for the plants inside the AGH than NAGH. The yield parameters such as total yield from plant, average fruit diameter, average fruit length, average fruit weight and number of fruits per plant were also greater in AGH than NAGH during 1st and 3rd crop seasons. For the second crop the yield parameters were almost same from both the greenhouses. This may be due to the reason that cooling system did not operate for the later two months in both the greenhouses during this season. Hence the yield obtained from both greenhouses was not significantly different.

Total yield obtained from AGH during first season was 7.89 kg/plant and from NAGH it was 2.15 kg/plant and the yield from AGH was 5.74 kg/plant greater than NAGH. There was significant difference in yield data from AGH and NAGH during first season. In the second season yield from AGH was 4.42 kg/plant and from NAGH it was 4.54 kg/plant. In this case yield from NAGH was greater by 0.12 kg/plant, but there was no significant difference between yield data from AGH and NAGH. Average yield from AGH during 3rd season was

7.18kg/plant and from NAGH it was 2.16kg/plant. Inside AGH, an incremental yield of 5.02 kg/plant was obtained during this season. There was significant difference between yield data obtained from AGH and NAGH. During second crop season the cooling system was not operated inside both greenhouses for about two months and hence same yield obtained from both greenhouses. During the other two seasons, cooling system was operated automatically inside the AGH and hence the yield was higher in AGH than NAGH. From the above data it can be concluded that automation system was capable of managing the greenhouse microclimate along with irrigation and fertigation operations inside the greenhouse.

REFERENCES

- Abbouda, S.K. and Almuhanha, E.A. 2012. Improvement of evaporative cooling system efficiency in greenhouses. *International Journal of Latest Trends in Agriculture and Food Science* 2(2):83-89.
- Adash, S.S., Jincy and Jinu, A. 2017. Development of evaporative cooling box for naturally ventilated greenhouse. B.Tech. (Agrl. Engg.) Project Report, Kerala Agricultural University, Thrissur, 68p.
- Ahmad, U., Subrata, M. and Arif, C. 2011. Speaking plant approach for automatic fertigation system in greenhouse. *Int. J. signal processing, image processing and pattern recognition*.4:1- 9.
- Ahonen T., Virrankoski R. and Elmusrati M. Greenhouse Monitoring with Wireless Sensor Network. University of Vaasa Department of Computer Science Telecommunication Engineering Group P.O. Box 700, FI-65101, Vaasa, Finland. Available online at http://lipas.uvasa.fi/~rvir/greenhouse_mesa08.pdf
- Ajwang, P.O. and Tantau, H.J. 2005. Prediction of the effect of insect proof screens climate in naturally ventilated greenhouse in humid tropical climates. *Acta Hort.* 691: 449-456.
- Albright, L.D. 1997. Ventilation and shading for cooling. *Proc. of the International seminar on protected cultivation in India*, Bangalore.
- Anand Zambre. 2013. Basics and advances in greenhouse covering films. *Floriculture today*: 27-30.

- Antille, D.L. 2017. Evaluation of fertigation applied to furrow and overhead irrigated cotton grown in a black vertosol in southern Queensland Australia. *Applied Engineering in Agriculture*. 34(1):197-211. Doi.10.13031/area.12519@2018.
- Arbel, A., Barak, M. and Shklyar, A. 2003. Combination of forced ventilation and fogging systems for cooling greenhouses. *Biosystems Engineering*, 84(1): 45-55.
- Ashokaraja and Kumar, A. 2001. Status and Issues of fertigation in India. In: Singh, H.P., Kaushish, S.P., Kumar, A., Murthy, T.S., Jose, C. and Samuel, E. (eds.), *Micro Irrigation*. Central Board of Irrigation and Power, New Delhi, 61p.
- Atia, D.M. and El-madany H.T. 2016. Analysis and Design of Greenhouse temperature control using Adaptive Neuro-Fuzzy Inference System. *J. Electr. Syst. Inform. Technol.* 133:1-15. Available online at www.sciencedirect.com <http://dx.doi.org/10.1016/j.jesit.2016.10.014>.
- Attavar, M. 1997. Relevance of Greenhouse technology in india. *Proc. of the International seminar on protected cultivation in India*, Bangalore.
- Bachav, S.M. 1995. Fertigation in India. In: *International Symposium on Fertigation*, Israel Institute of Technology, Israel, March 26-April 1, pp. 11-24.
- Baille, A., Kittas, C. and Katsoulas, N. 2001. Influence of whitening on greenhouse microclimate and crop energy partitioning. *Agricultural and Forest Meteorol.* 107(4): 293-306.
- Bajer, L. and Krejcar, O. 2015. Design and Realization of Low Cost Control for Greenhouse Environment with Remote Control. *Proceedings of the 13th IFAC Conference on Programmable Devices and Embedded Systems May 13-15*,

2015. *Cracow, Poland*. IFAC-PapersOnLine 48-4:368–373. Available online at www.sciencedirect.com
- Baker, J.C 1984. Effect of changes in ventilation on cucumber. *Acta Hort.*148:519-524.
- Bazea, E.J., Montero, J.I. and Gazquez, J.C. 2012. Analysis of the role of side wall vents on buoyancy driven natural ventilation in parallel type greenhouses with and without insect screens using computational fluid dynamics. *Biosystems Engng.* 10:328-339.
- Belsare, R., Deshmukh, K., Patil, M. and Hattarge, A.M. 2014. Smart Green House Automation. *International Journal of Computer Science & Engineering Technology* 5(12):1127-1129.
- Bennis, N., Duplaix, J., Enea, G., Haloua, M. and Youlal, H. 2008. Greenhouse Climate Modelling and Robust Control. *Computers and Electronics in Agriculture* 61: 96–107. Available at www.sciencedirect.com Journal homepage: www.elsevier.com/locate/compag
- Bhujbal, N., Vishnu, P. S. and Ratnaparkhi, M.R. 2012. Automated Green House Controller. *International Journal on Advanced Electrical and Electronics Engineering.* 1(1): 77-79.
- Bontsema, J., Henten, E.J.V., Kornet, J.G., Budding, J. and Rieswijk, T. 2005. On-Line Estimation of the Ventilation Rate of Greenhouses. Proceedings of the 16th Triennial World Congress, Prague, Czech Republic. ELSEVIER IFAC publications:125-130.
- Booij, P.S., Sijs, J. and Fransman, J.E. 2012. Localized climate control in greenhouses. 4th IFAC Nonlinear Model Predictive Control Conference.

- International Federation of Automatic Control, Noordwijkerhout, NL. August 23-27, 2012:454-459. Available at www.sciencedirect.com
- Both, A.J. 2015. Greenhouse Temperature Management. [https://hrt.msu.edu/Energy/Notebook/pdf/Sec2/Greenhouse Temperature Management by AJ Both.pdf](https://hrt.msu.edu/Energy/Notebook/pdf/Sec2/Greenhouse%20Temperature%20Management%20by%20AJ%20Both.pdf)
- Boulard, T., Feuilleley, P. and Kittas, C. 1997. Natural ventilaion performance of six greenhouses. *J. Agric. Engng. Res.*67:249-2664:86-96.
- Bozkurt, S. and Mansuroglu, G.S. 2009. The effects of drip line depths and irrigation levels on yield, quality and water use characteristics of lettuce. *Afr. J. Biotechnol.* 10(7): 3370-3379.
- Canadas, J., Molina, J.A.S., Rodriguez, F. and Aguila, I.M. 2017. Improving Automatic Climate Control with Decision Support techniques to Minimize Disease Effects in Greenhouse Tomatoes. *Information Processing in Agriculture* 4:50–63. Available at www.sciencedirect.com . journal homepage: www.elsevier.com/locate/inpa
- Cepeda, P., Ponce, P., Molina, A. and Lugo, E. 2013. Towards Sustainability of Protected Agriculture: Automatic Control and Structural Technologies Integration of an Intelligent Greenhouse. *11th IFAC Workshop on Intelligent Manufacturing Systems. The International Federation of Automatic Control.* May 22-24, 2013. São Paulo, Brazil: 366-371. Available at www.sciencedirect.com
- Chaudhary, D.D., Nayse, S.P. and Waghmare, L.M. 2011. Application of wireless sensor networks for greenhouse parameter control in precision agriculture. *International Journal of Wireless & Mobile Networks (IJWMN)*. 3(1):140-149.

- Dele, A.W.S and Kolawole, K.K. 2013. Microcontroller Based Green House Control Device. *The International Journal Of Engineering And Science* 2(11):129-135. Available at www.theijes.com
- Dhumal, Y.R. and J.S.Chitode, J.S. 2013. Green House Automation using Zigbee and Smart Phone . *International Journal of Advanced Research in Computer Science and Software Engineering*.3(5): 495-501. Available at www.ijarcsse.com
- Dinesh, M. and Saravanan, P. 2014. FPGA Based Real Time Monitoring System for Agricultural Field. *International Journal of Electronics and Computer Science Engineering*. 1(3): 1514-1519. Available at www.ijecse.org.
- Dondapati, P.P. and Rajulu, K.G. 2012. An automated multi sensed greenhouse management. *International Journal of Technological Explorations and Learning* 1(1):21-24.
- Ehret, D.L., Hill, B.D., Helmer, T. and Edwards, D.R. 2011. Neural network modeling of greenhouse tomato yield, growth and water use from automated crop monitoring data. *Computers and Electronics in Agriculture*. **79**:82–89. Available <http://www.elsevier.com/locate/compag>.
- Eldhose, K.A., Rosily, A., Mini, P.K., Krishnapriya, M.N. and Neenu, M.S. 2014. Automated Greenhouse Monitoring System. *International Journal of Engineering and Innovative Technology*. 3 (10):164-167.
- Farina, E., Battista, D. and Palagi, M. 2007. Automation of irrigation in hydroponics by FDR sensors-Experimental results from field trials. In: *8th IS on protected cultivation in mild winter climates*, 16 July2007.

- Fatnassi, H., Boulard, T. and Bouirden, L. 2003. Simulation of climatic conditions in full scale greenhouse fitted with insect proof screens. *Agricultural and Forest Meteorol.* 118(1-2): 97-111.
- Franco, A., Valera, D.L. and Pena, A. 2014. Energy efficiency in greenhouse evaporative cooling techniques : cooling boxes versus celluloid pads. *Energies* 7: 1427-1447. Doi: 10.3390/en7031427.
- Fuchs, M., Dayan, E., Shmuel, D. and Zipori, I. 1997. Effects of ventilation on the energy balance of a greenhouse with bare soil. *Agricultural and Forest Meteorol.* 86 (3-4): 273-282.
- Ganguly, A. and Ghosh, S. 2007. Modeling and analysis of a fan-pad ventilated floricultural greenhouse. *Energy and Buildings* 39(10): 1092-1097.
- Gautam, I. 2012. Innovative GSM Bluetooth based Remote Controlled Embedded System for Irrigation. *International Journal of Computer Applications.* 47(13):1-7.
- Gayatri, S.R. 2013. Greenhouse Automation System using Psoc 3. *Journal of Information, Knowledge and Research in Electronics and Communication Engineering.* 2(2):779-784.
- Ghosal , M.K., Tiwari, G.N. and Srivastava, N.S.L. 2003. Modeling and experimental validation of a greenhouse with evaporative cooling by moving water film over external shade cloth. *Energy and Buildings* 35(8): 843-850.
- Ghosal, M.K., Tiwari, G.N. and Srivastava, N.S.L. 2004. Thermal modeling of a greenhouse with an integrated earth to air heat exchanger: an experimental validation. *Energy and Buildings* 36(3): 219-227.

- Ghosal, M.K. and Tiwari, G.N. 2006. Modeling and parametric studies for thermal performance of an earth to air heat exchanger integrated with a greenhouse. *Energy Conversion and Manage.*47(13-14): 1779-1798.
- Gokul, A. J. and Hakkim, A.V.M. (2016). Comparative Evaluation of Naturally Ventilated Polyhouse and Rain Shelter on the Performance of Cowpea. *International Journal of Engineering Science and Computing.* 6(6): 2321-2328.
- Gowda, N.V. 1996. Nutrition and irrigation management in green house. In: Singh, H.P., Kaushish, S.P., Kumar, A., Murthy, T.S., Jose, C. and Samuel, E. (eds.), *Micro Irrigation.* Central Board of Irrigation and Power, New Delhi, 431p.
- Hagin. and Lowengart, A. 1996. Fertigation for minimizing environmental pollution by fertilizers. *Fertil. Res.*, 43(1-3): 5-7.
- Hahn, F. 2011. Fuzzy controller decreases tomato cracking in greenhouses. *Computers and Electronics in Agriculture* 77: 21–27. Available at www.sciencedirect.com Journal homepage: www.elsevier.com/locate/compag
- Haynes, R.J. 1985. Principles of fertilizer use for trickle irrigated crops. *Fertil. Res.* 6: 235-255.
- Helmer, T., Ehret, D. L. and Bittman, S. 2005. Crop Assist, an automated system for direct measurement of greenhouse tomato growth and water use. *Computers and Electronics in Agriculture* **48**:198–215. Available <http://www.elsevier.com/locate/compag>. doi:10.1016/j.compag.2005.04.005.
- Hochumuth, G.J. and Smajstrla, A.G. 2003. Fertilizer application and management for micro (drip) – Irrigated vegetables in Florida. Available:

[http://www.seaagri.com/docs/
fertilizer_application_for_drip_irrigated_vegetables.pdf](http://www.seaagri.com/docs/fertilizer_application_for_drip_irrigated_vegetables.pdf).

- Hussain, R.H., Marhoon, A.F. and Rashid, M.T. 2013. Wireless Monitor and Control System for Greenhouse. *International Journal of Computer Science and Mobile Computing* 2(12): 69-87. Available online at www.ijcsmc.com
- Iacomi, C., Rosca, I., Madjar, R., Iacomi, B., Popcsu, V., Varzaru, G. and Sfeetcu, C. 2014. Automation and computer-based technology for small vegetable farm holders. *Sci. Pap. Ser. Agron.* 7: 2285-5785.
- Imas, P. 1999. Recent techniques in fertigation of horticultural crops in Israel. In: *Workshop on recent trends in nutrition management in horticultural crops*. 11-12 February 1999. Dapoli, Maharashtra, India.
- Jain, V.K., Shukla, K.N. and Singh, P.K. 2001. Response of potato under drip irrigation and plastic mulching, In: Singh, H.P., Kaushish, S.P., Kumar, A., Murthy, T.S., Jose, C. and Samuel, E. (eds.), *Micro Irrigation*. Central Board of Irrigation and Power, New Delhi, pp. 49-27.
- Jain, D. and Tiwari, G.N. 2002. Modeling and optimal design of evaporative cooling system in controlled environment greenhouse. *Energy Conversion and Manage.* 43(16): 2235-2250.
- Jat R.A., Wani, S.P., Sahrawat, K.L., Singh, P. and Dhake, P.L. 2011. Fertigation in vegetable crops for higher productivity and resource use efficiency. *Indian Journal of fertilizers.* 7(3): 22-37.
- Jinu, A. and Hakkim, A.V.M. 2016. Automatic Microclimate Control in Greenhouses. *International Journal of Engineering Science and Computing* 6(8):2941-2946. Available at <http://ijesc.org/>

- Joteppagol, S.M. and Kore, S.K. 2015. Greenhouse Automation Using CAN Bus. *International Journal for Research in Emerging Science and Technology*.2(5):277-281.
- Junxiang, G. and Haiqing, D. 2011. Design of Greenhouse Surveillance System Based on Embedded Web Server Technology. *Procedia Engineering* **23**: 374 – 379. Available: <http://www.elsevier.com/locate/procedia>. doi:10.1016/j.proeng.2011.11.2516.
- Katsoulas, N., Baille, A. and Kittas, C. 2001. Effect of misting on transpiration and conductance of a greenhouse rose canopy. *Agricultural and Forest Meteorol.*106(3): 233-247.
- Kaur, B. and Kumar, D. 2013. Development of automated nutrients composition control fertigation system. *Int. J. Comput. Sci. Eng. Appl.* 3: 2-65.
- Khan, M.M., Shivashangar, K., Manohar, K. R., Sreerama, R. and Kariyanna. 1999. In: Singh, H.P., Kaushish, S.P., Kumar, A., Murthy, T.S., Jose, C. and Samuel, E. (eds.), *Micro Irrigation*. Central Board of Irrigation and Power, New Delhi, 79p.
- Khandelwal, S.A. 2012. Automated greenhouse management using GSM modem. *International Journal of Computerscience and Information Technologies* 3(1):3099-3102.
- Kia, P.J., Tabatabaee, F.A., Omid, M., Alimardani, R. and Naderloo, L. 2009. Intelligent Control Based Fuzzy Logic for Automation of Greenhouse Irrigation System and Evaluation in Relation to Conventional Systems. *World Applied Sciences Journal* 6 (1): 16-23.

- Kittas, C., Bartzanas, T. and Jaffrin, A. 2003. Temperature gradients in a partially shaded large greenhouse equipped with evaporative cooling pad. *Biosystems Engineering* 85(1): 87-94.
- Kittas, C., M. Tchamitchian, N., Katsoulas, P., Karaïskou and C.H. Papaioannou, 2006. Effect of two UV absorbing greenhouse covering films on growth and yield of an eggplant soilless crop. *Scientia Horticulturae* 110(1): 30-37.
- Kolhe, S.A. and Annadate, S.A. 2012. Implementation of Green House Automation using ARM7 Controller. *International Journal of Computer Applications* 47(20):1-5.
- Korner, O., Ooster, A.V. and Hulsbos, M. 2007. Design and performance of a measuring system for CO₂ exchange of a greenhouse crop at different light levels. *Biosystems engineering* 97:219-228. Available at www.sciencedirect.com
- Kozai, T. and Sase, S. 1978. A simulation of natural ventilation for a multi-span greenhouse. *Acta Hort.* 87:39-49.
- Kumar, A. 1992. Fertigation through drip irrigation. In: Singh, H.P., Kaushish, S.P., Kumar, A., Murthy, T.S., Jose, C. and Samuel, E. (eds.), *Micro Irrigation*. Central Board of Irrigation and Power, New Delhi, pp. 349-356.
- Kumar, V.G., Mani, T.D. and Selvaraj, P. K. 2007. Irrigaion and Fertigation Scheduling under drip Irrigation in Brinjal crop. *IJBSM.1* (2): 72-76.
- Kumari, G.V.L. and Anitha, S. 2006. Nutrient management in Chilli based cropping system. *Indian J. Crop Sci.* 1 (1-2): 209-210.
- Lee, S., Jiang, X., manubohi, M., Riedl, K., Ludsin, S.A., Martin, J.F. and Lee, J. 2017. Fresh produce and their soils accumulated cyanotoxins from irrigation

- water : Implications for public health and food security. *Food Research International*. 102:234-245. Available online at www.sciencedirect.com
- Li, S. and Willits, D.H. 2008. Comparing low pressure and high pressure fogging systems in naturally ventilated greenhouses. *Biosystems Engineering* 101(1): 69-77.
- Linker, R., Kacira, M. and Arbel, A. 2011. Robust Climate Control of a Greenhouse Equipped with Variable-Speed Fans and a Variable-Pressure Fogging System. *Biosystems Engineering*. 110 :153-167. Available online at www.sciencedirect.com. journal homepage: www.elsevier.com/locate/issn/15375110.
- Locascio, S.J. 2000. Management of irrigation for vegetables: past, present, and future. *Hortic. Technol.* 15: 482 – 485.
- Manickasundaram, P. 2005. Principles and practices of fertigation. In: Kandasamy, O.S., Velayudham, K., Ramasamy, S., Muthukrishnan, P., Devasenapathy, P. and Velayuthan, A. *Farming for the future: Ecological and Economic Issues and Strategies*. s.l., s.n., pp. 257 – 262.
- Manohar, K.R. and Igathinathen, C. 2007. *Greenhouse Technology and Management* (Reprint 2012). BS Publications, Hyderabad, pp. 1-107.
- Martinovic, G. and Simon, J. 2014. Greenhouse microclimatic environment controlled by a mobilemeasuring station. *NJAS - Wageningen Journal of Life Sciences* **70–71**: 61–70. Available: <http://www.elsevier.com/locate/njas>. doi.org/10.1016/j.njas.2014.05.007.
- Mears, D.R. 1991. Greenhouse environmental control for Indian conditions: new technologies and applications. *Proceedings of the international seminar on*

- new frontiers in horticulture*, Organised by Indo-American Hybrid seeds, Bangalore, India: 265-272.
- Michael, A.M. (1994). Irrigation Theory and Practice. Vikas Publishing House Private limited, New Delhi. Pp:662-681.
- Mikkelsen, R.L. 1989. Phosphorous fertilization through drip irrigation. *J. Prod. Agric.* 2(3): 279-286.
- Miranda, R.C., Ramos, Jr. E.V., Vera, R.R.P. and Ruiz G.H. 2006. Fuzzy Greenhouse Climate Control System based on a Field Programmable Gate Array. *Bio systems Engineering* 94 (2): 165–177. Available online at www.sciencedirect.com. doi: 10.1016/j.biosystemseng. 2006.02.012.
- Mohanty, N.R. and Patil, C.Y. 2013. Wireless Sensor Networks Design for Greenhouse Automation. *International Journal of Engineering and Innovative Technology* 3(2):257-262.
- Montero, J.I. and Anton, A. 1994. Greenhouse cooling during warm periods. *Acta Hort.* 357:49-60.
- Morari, F. and Giardini, L. 2002. Irrigation automation with heterogeneous vegetation: the case of Padova botanical garden. *Agricultural Water Management*. 55: 183-201. Available at www.Elsevier.com/locate/agwat.
- Mortvedt, J.J. 1997. Mineral nutrition of green house crops. In: Singh, H.P., Kaushish, S.P., Kumar, A., Murthy, T.S., Jose, C. and Samuel, E. (eds.), *Micro Irrigation*. Central Board of Irrigation and Power, New Delhi, 430p.
- Mutwiwa, U.N., Von. Elsner, B. and Tantau, H.J. 2008. Cooling naturally ventilated greenhouses in the tropics by near-infra red reflection. *Acta.Horticulture* 801: 259-266.

- Narayanamoorthy, A. 2001. Adoption of recommended use of fertilizers and its impacts on paddy yield: an analysis of determinants in ground water irrigated region. *Artha Vijnana*. 38 (4): 387-406.
- Neto, A.J.S., Zolnier, S. and Lopes, D.C. 2014. Development and evaluation of an automated system for fertigation control in soilless tomato production. *Comput.and Electr. in Agric.* 103:17–25.
- Nishina, H. 2015. Development of speaking plant approach technique for intelligent greenhouse. The 2014 International Conference on Agro-Industry (ICoA): competitive and sustainable agro industry for human welfare. Agriculture and agricultural science procedia. 3:9-13. Available at www.sciencedirect.com.
- Ota, T., Bontsema, J., Hayashi S., Kubota, K., Van Henten E.J., Van Os, E.A. and Ajiki, K. 2007. Development of a cucumber leaf picking device for greenhouse production. *Biosystems engineering* 98:381-390. Available at www.sciencedirect.com
- Palaniappan. S. P. 1985. *Cropping systems in the tropics-Principles and Management*. Wiley Eastern Ltd., New Delhi, p. 215.
- Papadakis, G, Mernier, M., Menesses, T.F. and Boulard, T. 1996. Measurement and analysis of air exchange rates in a greenhouse with continuous roof and side openings. *J. Agric. Res.* 63:219-228.
- Parvez, Z.S., Ahmed, F.J.S, Parvez, S.S. and Gadilingappa, K. 2014. Arm Based Automated Wireless Greenhouse Climate Management System using Zigbee Technology. *IOSR Journal of Electronics and Communication Engineering* . 9(3):55-62. Available at www.iosrjournals.org .

- Pawłowski, A., Sánchez-Molina, J.A., Guzmán, J.L., Rodríguez, F. and Dormido, S. (2017). Evaluation of event-based irrigation system control scheme for tomato crops in greenhouses. *Agricultural Water Management*. 183:16-25.
- Poyen, F., Bhattacharya, K., Mondal, A., Ghosh, A. and Bandyopadhyay, R. 2014. Sensor Based Automated Shading of Green House. *International conference on Innovative Engineering Technologies (ICIET'2014)* Dec. 28-29, 2014 Bangkok (Thailand):151-154. Available online at <http://dx.doi.org/10.15242/IIE.E1214047>.
- Prabhakar, M. and Hebbar, S.S. 1996. Micro Irrigation and Fertigation in Capsicum and tomato. In: *National Seminar on Problems and Prospects of Micro Irrigation – A Critical Appraisal*, Bangalore, 19-20 November 1999, pp.60-68.
- Radojevic, N., Kostadinovic, D., Vlajkovic, H. and Emil, V. 2014. Microclimate Control in Greenhouses. *FME Transactions* 42: 167-171.
- Raine, S.R. and McCarthy, A.C. 2014. Advances in intelligent and autonomous system to improve irrigation and fertilizer efficiency. Available:http://www.massey.ac.nz/~flrc/workshops/14/Manuscripts/Paper_Raine_2014.pdf.
- Rajinder, P.K. 1985. Greenhouse temperature control techniques. *Proc. of the summer institute on greenhouse design and environmental control*, CIAE, Bhopal.
- Ribeirio, E.C., Carvalho, D.F., Santos, L.A.F. and Guerra, J.G.M. 2015. Onion yield under agro ecological farming systems using distinct irrigation depths and soil

- covers. *Ciencia Rural*. 46(5): 103-109. <http://dx.doi.org/10.1590/0103-8478cr20150342>.
- Salih, J.E.M., Adom, A.H. and Shaakaf, A.Y.M. 2012. Solar Powered Automated Fertigation Control System for CucumisMelo L. Cultivation in Green House. *APCBEE Procedia* 4:79 – 87.
- Salleh, A., Ismail, M.K., Mohamad, N.R., Abd Aziz, M.Z.A., Othman, M.A. and Misran, M.H. 2013. Development of Greenhouse Monitoring using Wireless Sensor Network through ZigBee Technology. *International Journal of Engineering Science Invention*.2(7): 6-12. Available at www.ijesi.org.
- Salokhe, V.M. and Sharma, A.K. 2006. *Greenhouse Technology and Applications* (Reprint 2012). Agrotech Publishing Company, Udaipur, 280p.
- Savvas, D. 2002. Automated Replenishment of Recycled Greenhouse Effluents with Individual Nutrients in Hydroponics by Means of Two Alternative Models. *Biosystems Engineering*. 83 (2): 225–236. Available online at <http://www.idealibrary.com> doi:10.1016/S1537-5110(02)00152-6.
- Schmidt, T. 2015. Home greenhouse controller- Low Cost Greenhouse Automation. Available at http://www.tschmidt.com/writings/Greenhouse_Automation.pdf
- Sethi, V.P. and Sharma, S.K. 2007. Experimental and economic study of a greenhouse thermal control system using aquifer water. *Energy Conversion and Manage.*, 48(1): 306-319.
- Shaik Thasleem Bhanu, S.T. and Abhinesh, A. 2015. Greenhouse Automation using ZIGBEE and GSM Technologies. International Conference on Futuristic Trends in Computing and Communication (ICFTCC-2015): 5-19. Available at www.internationaljournalsrsg.org

- Sharan, G. 2010. Cropping in semi-arid northwest india in greenhouse with ground coupling shading and natural ventilation for environmental control. *International Journal for Service Learning in Engineering*. Spring 2010 ISSN 1555-9033, Vol. 5, No. 1: 148-169.
- Singh, A.K., Khanna, M.D., Chakraborty. and Kumar, A. 2001. In: Singh, H.P., Kaushish, S.P., Kumar, A., Murthy, T.S., Jose, C. and Samuel, E. (eds.), *Micro Irrigation*. Central Board of Irrigation and Power, New Delhi, 442p.
- Singh, H.P., Kumar, A. and Samuel, J. C. 2000. Micro irrigation for horticultural crops. *Indian Hortic.* 45(1): 272-276.
- Singh, S.K., Singh, P.K., Singh, K.K. and Shukla. 2001. Studies on Drip Irrigation Installation for litchi in Bhabhar region of Uttar Pradesh. In: Singh, H.P., Kaushish, S.P., Kumar, A., Murthy, T.S., Jose, C. and Samuel, E. (eds.), *Micro Irrigation*. Central Board of Irrigation and Power, New Delhi, 297p.
- Singh, V.K. 2009. Advances in plastic Material Technology: A Global Perspective. In: *Proceedings of the International Conference on Plasticulture and Precision Farming*, November 17 -21, pp. 523-528.
- Singhandhube, R.B., Rao, G.G.S.N., Patil, N.G. and Brahmanand, P.B. 2003. Fertigation studies and irrigation scheduling in drip irrigation system in tomato crop. *Eur. J. Agron.* pp. 1-17.
- Sonneveld, P.J., Swinkels, G.L.A.M., Bot, G.P.A. and Flamand, G. 2010. Feasibility study for combining cooling and high grade energy production in a solar greenhouse. *Biosystems Engineering* 105(1): 51-58.
- Srinivas, K. 1999. Micro Irrigation and Fertigation. In: Singh, H.P., Kaushish, S.P., Kumar, A., Murthy, T.S., Jose, C. and Samuel, E. (eds.), *Micro Irrigation*. Central Board of Irrigation and Power, New Delhi, 79p.

- Straten, G. V., Challa, H. and Bhuwalda, F. 2000. Towards user accepted optimal control of greenhouse climate. *Computers and Electronics in Agriculture*. 26:221-238. Available: www.elsevier.com/locate/compag
- Sunny, A. S. and Hakkim, A.V.M. 2017. Automated and non-automated fertigation systems inside the polyhouse- A comparative evaluation. *Int.J.Curr.Microbiol.App.Sci.* 6(5): 2328-2335. doi: <https://doi.org/10.20546/ijcmas.2017.605.260>.
- Sutar, R.F. and Tiwari, G.N. 1995. Analytical and numerical study of a controlled environment agricultural system for hot and dry climatic conditions. *Energy and Buildings*. 23(1): 9-18.
- Teitel, M. 2001. The effect of insect proof screens in roof openings on greenhouse microclimate. *Agricultural and Forest Meteorol.* 110(1): 13-25.
- Thenmozhi, S., Dhivya M.M., Sudharsan, R. and Nirmalakumari, K. 2014. Greenhouse Management Using Embedded System and Zigbee Technology. *International Journal of Advanced Research in Electrical, Electronics and Instrumentation Engineering*. 3(2):7382-7389. Available at www.ijareeie.com
- Toida, H., Kozai, T., Ohyama, K. and Handarto. 2006. Enhancing fog evaporation rate using an upward air stream to improve greenhouse cooling performance. *Biosystems Engineering* 93(2): 205-211. Doi:10.1016/j.biosystemseng.2005.11.003.
- Vargheese, A., Balan, M.T., Sajna, A. and Swetha, K.P. 2014. Cowpea inside polyhouse with varying irrigation and fertigation levels. *Int. J. Eng. Res. Dev.* 10: 18-21.

- Vidyasagar, B. 2012. Green House Monitoring and Automation using GSM. *International Journal of Scientific and Research Publications*.2(5):1-5. Available at www.ijsrp.org .
- Wang, Z. Y., Leng, Q., Huang, L., Xhao, L.L., Xu, Z.L., Hou, R.F. and Wang, C.W. 2009. Monitoring system for electrical signals in plants in the greenhouse and its applications. *Bio systems Engineering* **103**:1-11. Available: <http://www.elsevier.com/locate/issn/15375110>.doi:10.1016/j.biosystemseng.2009.01.013.
- Waykole, U.A. and Agrawal, D.G. 2012. Greenhouse AutomationSystem. 1st International Conference on RecentTrends in Engineering & Technology. Special Issue of *International Journal of electronics,Communication & Soft Computing Science &Engineering*.:161-166.
- White, J.W. and Aldrich, A. 1975. Progress report on energy conservation for greenhouses research. *Floriculture Rev.* 156: 63-65.
- Willits, D.H. 2003. Cooling fan ventilated greenhouse: a modeling study. *Biosystems Engineering*, 84(3): 315-329.
- Willits, D.H. and Peet, M.M. 2000. Intermittent application of water to an externally mounted greenhouse shade cloth to modify cooling performance. *Transactions of ASAE* 43(5): 1247-1252.
- Wilson, C. and Bauer, M. 2005. Drip Irrigation for home gardens. Available: http://prepperchicks0.homestead.com/~local/~Preview/Drip_Irrigation_for_Home_Gardens.pdf.
- Yasser, E., Essam, A. and Magdy, T. 2009. Impact of fertigation scheduling on Tomato yield under Arid Ecosystem Conditions. *Res. J. Agric. Biol. Sci.* 5(3): 280-286.

Appendix I

Average Microclimate Data without Crop

Time	Automated Greenhouse			Outside		
	Temperature (°C)	Relative humidity (%)	Light Intensity (lux)	Temperature (°C)	Relative humidity (%)	Light Intensity (lux)
10.00 am	32.2	67	40463	29.9	58	60263
11.00 am	35.1	69	47528	32.8	45	68439
12.00 noon	36.1	66	53274	35.1	40	75382
1.00 pm	36.3	65	48962	36.1	36	71592
2.00 pm	36.8	61	43582	36.5	31	64836
3.00 pm	36.4	67	43826	36.1	37	63483
4.00 pm	35.4	65	44152	33.9	41	53851
5.00 pm	35.3	56	27529	32.7	47	41738

Appendix II

Average Microclimate Data during First Crop

Time	Automated greenhouse			Non automated greenhouse			Outside		
	Temperature (⁰ C)	Relative humidity (%)	Light Intensity (lux)	Temperature (⁰ C)	Relative humidity (%)	Light Intensity (lux)	Temperature (⁰ C)	Relative humidity (%)	Light Intensity (lux)
10.00 am	33.8	56	39461	34.3	45	39610	31.8	51	58283
11.00 am	35.8	61	46567	38.9	44	46637	34.7	38	65904
12.00 noon	36.8	66	52995	41.1	39	52760	36.4	34	74809
1.00 pm	37.5	68	51029	42.4	36	51236	37.0	31	72599
2.00 pm	37.8	69	48905	43.2	33	49106	37.6	28	69851
3.00 pm	36.9	66	42495	41.3	38	42581	36.3	32	62960
4.00 pm	36.1	62	35719	38.8	42	36113	35.0	37	52584
5.00 pm	35.2	57	24955	35.6	48	25387	33.4	43	38704

Appendix III

Average Microclimate Data during December 2015 (First Crop)

Time	Automated greenhouse			Non automated greenhouse			Outside		
	Temperature (°C)	Relative humidity (%)	Light Intensity (lux)	Temperature (°C)	Relative humidity (%)	Light Intensity (lux)	Temperature (°C)	Relative humidity (%)	Light Intensity (lux)
10.00 am	32.8	61	38993	33.0	50	38950	30.3	55	57824
11.00 am	35.3	57	48343	37.6	45	49048	33.2	39	69463
12.00 noon	36.2	64	52330	39.4	41	52278	35.4	35	73659
1.00 pm	36.5	66	48598	40.7	36	48895	36.1	32	70145
2.00 pm	36.7	68	45937	41.7	34	46655	36.5	30	66834
3.00 pm	36.4	65	44462	40.1	38	44454	35.6	34	64372
4.00 pm	35.8	60	38696	37.4	42	38937	33.9	37	51898
5.00 pm	34.9	59	26773	35.1	50	27401	32.5	43	41004

Appendix IV

Average Microclimate Data during January 2016 (First Crop)

Time	Automated greenhouse			Non automated greenhouse			Outside		
	Temperature (⁰ C)	Relative humidity (%)	Light Intensity (lux)	Temperature (⁰ C)	Relative humidity (%)	Light Intensity (lux)	Temperature (⁰ C)	Relative humidity (%)	Light Intensity (lux)
10.00 am	32.7	54.0	39003	33.4	45.5	39158	31.0	49.5	56653
11.00 am	35.2	58.5	42771	37.7	47.5	42794	34.1	44.0	62217
12.00 noon	36.0	62.8	48223	39.7	41.8	48646	35.6	37.8	69136
1.00 pm	36.8	67.0	47362	41.3	38.5	47616	36.2	36.3	67907
2.00 pm	37.0	68.8	46312	42.0	34.3	46488	36.9	30.0	66075
3.00 pm	36.4	65.0	40598	40.1	38.5	40721	35.5	33.8	59724
4.00 pm	35.9	60.5	34493	37.8	41.5	35283	34.6	36.8	51758
5.00 pm	35.1	56.0	23295	35.1	48.0	23446	33.0	41.8	35795

Appendix V

Average Microclimate Data during February 2016 (First Crop)

Time	Automated greenhouse			Non automated greenhouse			Outside		
	Temperature (°C)	Relative humidity (%)	Light Intensity (lux)	Temperature (°C)	Relative humidity (%)	Light Intensity (lux)	Temperature (°C)	Relative humidity (%)	Light Intensity (lux)
10.00 am	34.0	53.0	36697	34.4	45.0	37075	31.9	50.0	54256
11.00 am	35.6	60.5	42797	38.5	44.0	42783	34.7	37.3	62514
12.00 noon	36.8	65.5	50098	41.3	40.5	50344	36.5	35.3	71717
1.00 pm	37.5	68.0	48711	42.5	36.0	48609	37.1	28.8	70270
2.00 pm	37.9	69.0	46347	43.5	34.0	46197	37.7	27.5	67139
3.00 pm	36.7	66.3	40652	41.3	39.0	40517	36.2	32.5	60162
4.00 pm	36.2	62.0	33305	38.8	45.5	33710	35.0	41.3	49535
5.00 pm	35.1	54.5	22098	35.3	50.3	22614	33.5	46.3	35359

Appendix VI

Average Microclimate Data during March 2016 (First Crop)

Time	Automated greenhouse			Non automated greenhouse			Outside		
	Temperature (⁰ C)	Relative humidity (%)	Light Intensity (lux)	Temperature (⁰ C)	Relative humidity (%)	Light Intensity (lux)	Temperature (⁰ C)	Relative humidity (%)	Light Intensity (lux)
10.00 am	35.9	57	43152	36.5	39.5	43258	34.0	48.0	64399
11.00 am	37.0	66	52358	41.9	37.5	51922	36.7	32.5	69421
12.00 noon	38.4	70	61328	44.1	34.5	59773	38.1	28.0	84722
1.00 pm	39.1	70	59443	45.3	32.0	59825	38.7	25.5	82074
2.00 pm	39.7	70	57024	45.9	30.5	57082	39.3	23.0	79355
3.00 pm	38.1	68	44267	43.7	34.5	44632	37.8	27.5	67583
4.00 pm	36.7	67	36380	41.4	38.5	36522	36.4	32.0	57145
5.00 pm	35.7	60	27652	36.9	45.5	28085	34.6	40.0	42657

Appendix VII

Average Microclimate Data during Second Crop

Time	Automated greenhouse			Non automated greenhouse			Outside		
	Temperature (°C)	Relative humidity (%)	Light Intensity (lux)	Temperature (°C)	Relative humidity (%)	Light Intensity (lux)	Temperature (°C)	Relative humidity (%)	Light Intensity (lux)
10.00 am	31.7	71	19887	32.3	68	20236	29.6	67	36170
11.00 am	34.0	66	26056	35.1	60	26474	31.9	58	42898
12.00 noon	35.6	64	30948	37.1	54	31491	33.4	53	49206
1.00 pm	36.3	62	26155	38.3	50	26629	34.2	50	43895
2.00 pm	36.9	59	24255	39.2	47	24561	34.7	48	39832
3.00 pm	35.3	64	17429	37.2	55	17762	33.5	54	30783
4.00 pm	34.1	66	13459	35.1	62	13794	31.9	61	24208
5.00 pm	31.1	74	8354	31.4	71	8576	29.1	72	15956

Appendix VIII

Average Microclimate Data during May 2016 (Second Crop)

Time	Automated greenhouse			Non automated greenhouse			Outside		
	Temperature (⁰ C)	Relative humidity (%)	Light Intensity (lux)	Temperature (⁰ C)	Relative humidity (%)	Light Intensity (lux)	Temperature (⁰ C)	Relative humidity (%)	Light Intensity (lux)
10.00 am	34.5	65.5	29905	36.0	56.3	30565	32.5	44.3	48505
11.00 am	36.0	65.5	37762	39.3	49.5	38390	35.0	29.8	57730
12.00 noon	37.0	68.5	47832	41.2	44.0	48590	36.2	28.5	69473
1.00 pm	37.7	70.0	43523	42.8	41.0	44513	37.4	27.5	65079
2.00 pm	38.6	69.8	42758	44.3	38.0	43756	38.1	26.0	61239
3.00 pm	36.9	68.0	27078	41.9	45.8	27972	36.8	32.0	44406
4.00 pm	35.9	66.0	19624	38.9	53.8	20133	34.7	36.3	32156
5.00 pm	34.2	67.3	9571	35.0	61.8	10045	32.3	50.0	18060

Appendix IX

Average Microclimate Data during June 2016 (Second Crop)

Time	Automated greenhouse			Non automated greenhouse			Outside		
	Temperature (⁰ C)	Relative humidity (%)	Light Intensity (lux)	Temperature (⁰ C)	Relative humidity (%)	Light Intensity (lux)	Temperature (⁰ C)	Relative humidity (%)	Light Intensity (lux)
10.00 am	30.1	71.6	14412	30.2	72.2	14572	27.9	77.6	29413
11.00 am	33.1	66.4	20874	33.2	64.2	21146	30.4	72.0	35725
12.00 noon	34.5	62.8	23495	34.9	58.6	23906	31.8	64.6	39691
1.00 pm	35.4	59.2	17939	36.5	54.2	18202	32.7	60.4	33714
2.00 pm	35.9	57.0	15697	36.9	51.6	15541	33.0	59.0	29430
3.00 pm	34.3	62.2	11821	35.0	59.6	11905	31.7	65.2	22857
4.00 pm	32.6	67.4	9605	32.8	66.8	10054	30.0	74.2	18888
5.00 pm	28.7	79.2	6339	28.9	78.2	6508	26.9	88.0	13622

Appendix X

Average Microclimate Data during July 2016 (Second Crop)

Time	Automated greenhouse			Non automated greenhouse			Outside		
	Temperature (⁰ C)	Relative humidity(%)	Light Intensity (lux)	Temperature (⁰ C)	Relative humidity(%)	Light Intensity (lux)	Temperature (⁰ C)	Relative humidity(%)	Light Intensity (lux)
10.00 am	30.5	75.5	15345	30.7	74.0	15572	28.4	79.0	30592
11.00 am	32.9	67.0	19533	32.9	66.0	19887	30.2	73.3	35238
12.00 noon	35.4	61.5	21518	35.4	59.8	21977	32.3	66.5	38453
1.00 pm	35.8	55.8	17003	35.8	54.8	17173	32.6	62.8	32892
2.00 pm	36.3	51.5	14310	36.3	52.0	14386	32.9	59.0	28828
3.00 pm	34.6	61.3	13387	34.8	59.8	13408	32.1	64.8	25085
4.00 pm	33.8	65.3	11149	33.7	63.8	11195	30.9	71.3	21579
5.00 pm	30.3	75.5	9153	30.3	74.0	9176	28.0	79.3	16187

Appendix XI

Average Microclimate Data during Third Crop

Time	Automated greenhouse			Non automated greenhouse			Outside		
	Temperature (°C)	Relative humidity (%)	Light Intensity (lux)	Temperature (°C)	Relative humidity (%)	Light Intensity (lux)	Temperature (°C)	Relative humidity (%)	Light Intensity (lux)
10.00 am	32.0	59	35339	32.5	52	35832	30.5	59	54123
11.00 am	35.1	65	43672	37.0	48	43652	33.9	43	65520
12.00 noon	36.6	67	47760	41.0	43	47944	36.3	38	70548
1.00 pm	37.0	68	45921	41.9	39	45964	36.8	34	68075
2.00 pm	37.5	69	43505	43.0	35	43621	37.1	30	65395
3.00 pm	36.6	66	40710	41.0	40	40697	36.3	33	60932
4.00 pm	35.9	62	33554	38.6	46	33612	34.8	38	48704
5.00 pm	34.5	63	22927	35.2	55	23122	33.3	45	37541

Appendix XII

Average Microclimate Data during November 2016 (Third Crop)

Time	Automated greenhouse			Non automated greenhouse			Outside		
	Temperature (⁰ C)	Relative humidity (%)	Light Intensity (lux)	Temperature (⁰ C)	Relative humidity (%)	Light Intensity (lux)	Temperature (⁰ C)	Relative humidity (%)	Light Intensity (lux)
10.00 am	32.2	55	35459	32.6	51	35972	30.5	56	54369
11.00 am	35.4	63	45468	38.1	45	45281	34.3	41	67595
12.00 noon	36.8	67	49591	41.2	41	49873	36.4	36	72639
1.00 pm	36.9	68	48857	41.7	36	48642	36.8	32	70846
2.00 pm	37.6	70	46819	43.4	33	46752	37.3	29	68153
3.00 pm	36.7	69	41595	41.3	35	41648	36.5	31	59317
4.00 pm	35.8	61	34718	39.6	40	34837	35.2	36	47539
5.00 pm	34.7	57	25492	35.9	49	25428	33.6	41	38421

Appendix XIII

Average Microclimate Data during December 2016 (Third Crop)

Time	Automated greenhouse			Non automated greenhouse			Outside		
	Temperature (°C)	Relative humidity (%)	Light Intensity (lux)	Temperature (°C)	Relative humidity (%)	Light Intensity (lux)	Temperature (°C)	Relative humidity (%)	Light Intensity (lux)
10.00 am	31.4	57.0	33063	31.5	56.6	34051	29.9	62.0	52587
11.00 am	34.8	66.2	42078	35.8	51.2	41917	33.3	45.4	63813
12.00 noon	36.1	66.8	45125	39.7	44.2	45277	35.6	40.0	67739
1.00 pm	36.8	68.4	43008	41.1	39.8	43067	36.2	35.8	65279
2.00 pm	37.0	69.0	40677	42.0	36.8	40755	36.6	31.6	62612
3.00 pm	36.4	66.0	38356	40.1	42.2	38463	35.9	35.4	59403
4.00 pm	35.9	63.8	32707	38.0	47.6	32711	34.5	40.0	49158
5.00 pm	34.4	63.6	21450	34.3	57.4	21510	33.1	48.8	36551

Appendix XIV

Average Microclimate Data during January 2017 (Third Crop)

Time	Automated greenhouse			Non automated greenhouse			Outside		
	Temperature (⁰ C)	Relative humidity (%)	Light Intensity (lux)	Temperature (⁰ C)	Relative humidity (%)	Light Intensity (lux)	Temperature (⁰ C)	Relative humidity (%)	Light Intensity (lux)
10.00 am	32.4	57.5	34769	32.7	51.5	35186	30.5	59.8	51498
11.00 am	34.9	63.8	41869	36.8	50.5	41914	33.9	45.3	61909
12.00 noon	36.6	68.5	46500	40.9	44.5	46858	36.2	39.3	68972
1.00 pm	37.0	67.8	44730	42.2	39.8	44860	36.9	33.5	66471
2.00 pm	37.5	68.5	42857	43.1	36.0	42954	37.2	29.8	64037
3.00 pm	36.5	63.3	40415	41.2	41.8	40253	36.4	32.5	60771
4.00 pm	36.0	61.0	31705	38.9	48.0	31707	35.1	38.8	47596
5.00 pm	34.6	64.8	20439	34.9	57.5	20529	33.4	45.3	35439

Appendix XV

Average Microclimate Data during February 2017 (Third Crop)

Time	Automated greenhouse			Non automated greenhouse			Outside		
	Temperature (°C)	Relative humidity (%)	Light Intensity (lux)	Temperature (°C)	Relative humidity (%)	Light Intensity (lux)	Temperature (°C)	Relative humidity (%)	Light Intensity (lux)
10.00 am	32.0	67.7	38063	33.3	49.7	38118	31.2	56.7	58038
11.00 am	35.3	65.3	45274	37.5	46.3	45497	34.2	42.0	68762
12.00 noon	37.0	65.3	49825	42.0	42.3	49767	36.8	37.0	72840
1.00 pm	37.4	69.0	47090	42.5	38.3	47285	37.1	32.7	69703
2.00 pm	37.8	69.3	43667	43.6	35.3	44023	37.4	28.7	66777
3.00 pm	36.6	66.3	42475	41.7	41.7	42424	36.2	34.3	64237
4.00 pm	35.9	63.7	35086	37.8	48.0	35193	34.3	37.7	50523
5.00 pm	34.4	65.3	24327	35.8	55.7	25021	33.2	43.3	39752

**EVALUATION AND REFINEMENT OF LOW COST AUTOMATION SYSTEM FOR
NATURALLY VENTILATED GREENHOUSE**

by

JINU A.

(2014-28-101)

ABSTRACT OF THESIS

Submitted in partial fulfillment of the requirement for the degree of

***DOCTOR OF PHILOSOPHY IN
AGRICULTURAL ENGINEERING***

(Soil and Water Engineering)

Faculty of Agricultural Engineering and Technology

Kerala Agricultural University



Department of Soil and Water Conservation Engineering

KELAPPAJI COLLEGE OF AGRICULTURAL ENGINEERING AND TECHNOLOGY

TAVANUR, MALAPPURAM-679 573

KERALA, INDIA

2019

ABSTRACT

Greenhouses are structures used for offseason cultivation of crops and also for obtaining maximum production from unit area. In greenhouses, crop growing environment as well as growing medium can be modified by adopting suitable technologies for microclimate control and water and fertilizer application. Manual controls of microclimate and water and fertilizer application are time and labour consuming and hence automation is required for the better greenhouse management. The study entitled “Evaluation and refinement of low cost automation system for naturally ventilated greenhouses” was conducted during the period July 2015 to February 2017 to modify the existing low cost automation system at ARS Anakkayam and also for its performance evaluation. Existing automation system has limitations such as it cannot manage temperature and relative humidity separately and also it cannot manage irrigation and fertigation. These problems were rectified in refined automation system. The refinement of the system was done by changing the microcontroller used in the automation system and also using a timer for the timely management of irrigation and fertigation. The refined system was capable of managing temperature and relative humidity separately and performing irrigation and fertigation operations inside the greenhouse. The refined automation system was tested without crop and with crop during three crop seasons with salad cucumber crop (variety Saniya) inside the greenhouse. The experiment was conducted inside a naturally ventilated greenhouse situated at the ARS, Anakkayam, under Kerala Agricultural University. For comparison, salad cucumber was cultivated inside another greenhouse which is manually controlled. Microclimate as well as crop data were collected from outside the greenhouse and both these greenhouses and compared. The temperature inside the AGH was less compared to NAGH and the relative humidity inside the automated greenhouse never exceeded above 70%. The yield and all other crop parameters were better in AGH compared to NAGH.