

**DEVELOPMENT OF AN AUTOMATIC CLEANING MECHANISM FOR
ROOF WATER HARVESTING**

By
LAKSHMINARAYANA S. V.
(2014 - 18 - 114)



DEPARTMENT OF LAND & WATER RESOURCES AND CONSERVATION ENGINEERING
KELAPPAJI COLLEGE OF AGRICULTURAL ENGINEERING AND TECHNOLOGY
TAVANUR- 679573, KERALA
2016

**DEVELOPMENT OF AN AUTOMATIC CLEANING MECHANISM FOR
ROOF WATER HARVESTING**

**By
LAKSHMINARAYANA S. V.
(2014 - 18 - 114)**

THESIS

**Submitted in partial fulfilment of the
requirement for the degree of**

MASTER OF TECHNOLOGY

IN

AGRICULTURAL ENGINEERING

(Soil and Water Engineering)

Faculty of Agricultural Engineering & Technology

Kerala Agricultural University



**DEPARTMENT OF LAND & WATER RESOURCES AND CONSERVATION ENGINEERING
KELAPPAJI COLLEGE OF AGRICULTURAL ENGINEERING AND TECHNOLOGY**

TAVANUR- 679573, KERALA

2016

DECLARATION

I, hereby declare that this thesis entitled “**Development of an automatic cleaning mechanism for roof water harvesting**” is a bonafide record of research done by me during the course of research and the thesis has not previously formed the basis for the award to me of any degree, diploma, associateship, fellowship or other similar title, of any other University or Society.

Tavanur,

Date:

Lakshminarayana S.V.

(2014 - 18 - 114)

CERTIFICATE

Certified that this thesis entitled “**Development of an automatic cleaning mechanism for roof water harvesting**” is a record of research work done independently by **Mr. Lakshminarayana S.V (2014-18-114)** under my guidance and supervision and that it has not previously formed the basis for the award of any degree, diploma, fellowship or associateship to her.

Tavanur,
Date:

Dr. Sathian, K.K
(Major Advisor, Advisory Committee)
Professor
Department of Land & Water
Resources and Conservation Engineering
KCAET, Kerala agricultural University
Tavanur, Malappuram, Kerala

ACKNOWLEDGEMENT

*It is a matter of profound and privilege to give deep sense of gratitude and indebtedness to **Dr.Sathian, K.K**, Professor, Dept. of LWRCE, KCAET, Tavanur for his valuable guidance, constructive criticism and constant encouragement during the course of this research work and in the preparation of manuscript.*

*Words seem to be inadequate to express my sincere thanks to **Dr. M. Sivaswami**, Former Dean, KCAET, Tavanur for his professional guidance and constructive suggestions offered during this study. I express my heartfelt thanks to **Dr.Hajilal M.S**, Dean, KCAET, Faculty of Agricultural Engineering and Technology for the unfailing guidance and support that he offered while carrying out the project work.*

*I express my heartfelt thanks to **Dr.Abdhul Hakkim, V.M**, Professor and Head, Department of Land and Water Resources and Conservation Engineering, KCAET, Tavanur for the valuable advices, encouragement, sincere help and co-operation and for the evaluation of my thesis.*

*I engrave my deep sense of gratitude to **Er.Shivaji, K. P**, Assistant Professor Department of FPME KCAET, Tavanur for his valuable suggestions, evaluation and due encouragement during the entire period of this project work.*

*It is my pleasure to offer whole hearted thanks to **Er. Priya G Nair** Assistant Professor, Department of Land and Water Resources and Conservation Engineering, KCAET, Tavanur for giving valuable suggestions and constant backing at all stages of this research work.*

*I am immensely thankful to **Dr. Rema, K.P**, Professor, Dept. of IDE, for her sincere help and co-operation for the completion of this work.*

*I express my thanks to **Mr. Sreekumaran, S.**, Assistant Librarian, and all other **staff members of Library**, KCAET, Tavanur, for their ever willing help and cooperation.*

With great pleasure I express my heartfelt thanks to all teachers of KCAET Tavanur for their support during my thesis work.

*My heartfelt gratitude to **Mr. Mansoor, Mr. Prasoona** and **Mr. Mohammedkutti, T.**, Workshop Technicians of this college and **Mr. Unnikrishnan**, Lab Assistant, for their sincere help and support.*

My sincere thanks are extended to my batch mates at KCAET for their remarkable co-operation and encouragement during the tenure of my M.Tech programme.

*I like to mention heartfelt thanks to my seniors **Swatha, V. S.** and **Shijila Erikottil** for their timely help and support rendered to this work.*

I express my deep sense of gratitude to my loving parents and family members for their continuous support and inspiration all through my studies.

Above all, I bow my head before the Almighty for the blessing and procurement bestowed on me to complete this work.

Lakshminarayana, S.V

CONTENTS

Chapter No.	Title	Page No.
	LIST OF TABLES	vi
	LIST OF FIGURES	vii
	LIST OF PLATES	viii
	SYMBOLS AND ABBREVIATIONS	ix
1	INTRODUCTION	1
2	REVIEW OF LITERATURE	5
3	MATERIALS AND METHODS	27
4	RESULTS AND DISCUSSIONS	45
5	SUMMARY AND CONCLUSION	74
	REFERENCES	77
	APPENDICES	82
	ABSTRACT	

LIST OF TABLES

Table No.	Title	Page No.
2.1	Quality parameters with different standards	20
2.2	WHO's drinking water standards for organic compounds	22
3.1	Mesh area and slot area of different filter element	29
4.1	pH of roof water samples	45
4.2	EC of roof water samples	49
4.3	TDS of roof water samples	51
4.4	Salinity of roof water samples	54
4.5	TSS of roof water samples	57
4.6	pH of water samples for first flush system	59
4.7	EC of roof water samples for first flush system	61
4.8	TDS of roof water samples for first flush system	63
4.9	Salinity of roof water samples for first flush system	66
4.10	TSS of roof water samples for first flush system	68
4.11	Filtration efficiency of different micro mesh filters	71
4.12	Discharge rate of different filters	73

LIST OF FIGURES

Figure No.	Title	Page No.
3.1	Sectional view of the upward flow micro mesh filter system	28
3.2	Sectional view of micro mesh filter element	30
3.3	Upward flow micro mesh filter with an automatic flush	30
3.4	Sectional view of the first flush system	32
3.5	Complete sectional view of the first flush and mesh filter system	34
3.6	Circuit diagram of automatic flush	36
4.1	pH of roof water samples	48
4.2	EC of roof water samples	50
4.3	TDS of roof water samples	53
4.4	Salinity pH of roof water samples	56
4.5	TSS of roof water samples	58
4.6	pH of roof water samples for first flush system	61
4.7	EC of roof water samples for first flush system	63
4.8	TDS of roof water samples for first flush system	65
4.9	Salinity of roof water samples for first flush system	67
4.10	TSS of roof water samples for first flush system	69
4.11	Concentration of impurities (g/100l) with and without flush out	70
4.12	Filtration efficiency of different micro mesh filters	72

LIST OF PLATES

Plate No.	Title	Page No.
3.1	Systronic water quality analyser	38
3.2	pH of electrode	39
3.3	Conductivity cell	40
3.4	Gravimetric experimental setup	43

SYMBOLS AND ABBREVIATIONS

l	-	Litre
m	-	Meters
m ²	-	Square Meter
m ³	-	Cubic Meters
°C	-	Degree Centigrade
μ	-	Micron
ml	-	Millilitres
mm ³	-	Million Cubic Meters
mm	-	Millimetres
mg/l	-	Milligrams Per Litre
km ²	-	Kilometre Square
i.e.	-	That is
cm ²	-	Centimetre Square
φ	-	Diameter
l/h	-	Litre Per Hour
ds/m	-	Decisiemens per Meter
ms/Cm	-	Micro Siemens per Centimetre
ppt	-	Parts per Thousand
ppm	-	Parts per Million

l/s	-	Litre per Second
AHP	-	Analytical Hierarchy Process
BUET	-	Bangladesh University Of Engineering Technology
BOD	-	Biological Oxygen Demand
BIS	-	Bureau Of Indian Standards
COD	-	Chemical Oxygen Demand
CPCRI	-	Central Plantation Crops Research Institute
DRWH	-	Domestic Rooftop Water Harvesting
DO	-	Dissolved Oxygen
EC	-	Electrical Conductivity
Fig	-	Figure
KAU	-	Kerala Agricultural University
KCAET	-	Kelappaji College of Agricultural Engineering Technology
KSCST	-	Karnataka State Council for Science And Technology
LCD	-	Liquid Crystal Display
NRDC	-	National Research Development Corporation
NTU	-	Nephelometric Turbidity Units
No.	-	Number
PWS	-	Potential Annual Water Savings
PVC	-	Poly Vinyl Chloride
PWS	-	Potential Annual Water Savings
RWH	-	Rain Water Harvesting

RWHS	-	Rain Water Harvesting System
RCC	-	Reinforced Cement Concrete
RC	-	Runoff Coefficient
SMCL	-	Secondary Maximum Contaminant Level
SAL	-	Salinity
TSS	-	Total Suspended Solids
TDS	-	Total Dissolved Solids
UNICEF	-	United Nations International Children's Emergency Fund
UK	-	United Kingdom
US	-	United States
UV	-	Ultraviolet
USEPA	-	United States Environmental Protection Agency
Viz.	-	Namely
WHO	-	World Health Organization

CHAPTER 1

INTRODUCTION

Water is one of the most important natural resources on the earth essentially required by all forms of life. However, its availability on the earth surface in all parts of the world is declining due to the climatic change, such as altered weather pattern (including droughts and floods), rate of increase in population growth and change in life style. Water demand has increased greatly over the recent decades and it has led to the over exploitation of ground water and consequent drying up of open and tube wells. This scarcity is not restricted to our nation and the state of Kerala, but it is a global issue mainly due to the above said reasons. Both rural and urban areas of India experiences water scarcity of different orders. In general rural areas have decentralized water supply system and urban areas are equipped with centralized water supply. In both the cases non-availability of water is very common leading to the failure of the whole system.

The state of Kerala occupies the highest position of 97.6 percentile in the case of water availability with an average annual rainfall of 3000 mm. The availability of water is more during the south-west monsoon which starts from June and extends up to September is about 75% of the annual rainfall is received during this period. Most of the aquifers in the kerala state are unconfined. In an unconfined aquifer water storage is very low due to its low thickness. Unconfined aquifer in many places is composed by hard rocks with very little fissures and fractures to facilitate storage and movement of water. As a result, the state has very low ground water potential. This will lead to water shortage immediately after the recession of the monsoon. Hence, it is important to take adequate measures to meet the availability of drinking water and other domestic needs as a first priority and then irrigation and other needs.

The ultimate source of fresh water is in the form of precipitation and it is the major source of consumption for human and animals. It has neutral pH approximately and is free from salts, minerals, disinfection by-products and other natural and artificial contaminants. Hence, rainwater harvesting techniques, which

is low cost and technologically simple, may be adopted to tide over a water scarcity especially for agricultural and domestic purpose. This harvested rainwater could be stored and reused. The rainwater harvesting is a technique used for collecting and storing rainwater from the land surface or rock catchments and rooftops using simple methods such as pots, tanks and check dams. It can be recharged into the ground to improve ground water storage.

By all means, rain water harvesting is considered as the best method for solving the problem of water scarcity in all parts of the world. There are many ways of harvesting rain water, such as capturing runoff from rooftops, courtyards, catchments, collecting the seasonal flood waters from local streams and conserving water through watershed management. Rain water harvesting for domestic use involves collecting pure water from the cleaner surfaces such as rooftops of residential buildings. Rainwater harvesting has been adopted since centuries back in many countries. Especially in a country like India having several places of extreme water scarcity. The rainwater is commonly used for potable and non-potable uses, such as drinking, domestic, agricultural, industrial, ground water recharge and electricity generation. Presently many types and methods of rainwater harvesting are adopted all over the world in order to conserve the rain water.

Domestic rainwater harvesting has started making impact in many countries (especially in India) as another household water supply possibility. This reasons for the adoption of this method probably, are (1) Decrease in the quality and quantity of both surface water and groundwater, (2) Improvement in roofing material from thatched to more impervious materials like tiles, corrugated iron sheets, and asbestos, (3) Many piped water schemes has been failure due to poor maintenance, (4) due to availability of low cost rainwater harvesting materials, (5) shift from more central to decentralized organisation and improvement of water resources and (6) increase in competition between different sections of the society and the global trend towards rural to urban migration. In Kerala domestic rain harvesting from rooftop is most important categories of rainwater harvesting.

Rainwater harvesting is a technology which is most eco-friendly and adaptable to a very wide variety of situations and conditions. In areas where there is variations in the seasonal rainfall pattern, the balancing of water supply and demand would be difficult. In such cases, roof water harvesting play an important role. Rainwater falling on the roof surfaces become impure and dirty due to many substances like bird droppings, dust, dirt, leaves present on the rooftop etc. It is important that the initial rooftop runoff should be diverted away from the storage tank to avoid contamination. Therefor it is desirable that pure water is allowed to flow into to the storage tank after contaminants are washed away by initial rainfall for few minutes. The storage tank should be cleaned annually, otherwise some of the algae and vegetative growth can cause contaminate he pure water in the storage tank, especially when water in the storage tank is stored for a long period. The storage tank should be well protected from insects breeding and high windblown places.

There are several process and methods of removing contaminants from water (water purifications or treatment). The kind of water treatments depend on whether the water is used for potable purposes or for non-potable purposes. The water that is intended for potable use must undergo higher levels of treatments than the use intended for non-potable purposes such as irrigation and other uses. The quality of roof water can be improved considerably by separation of debris from the rooftop rainwater. To maintain the quality of water, filters and separators can be used in rainwater harvesting system at the inlet. Filters separates the debris and allow the clean water flow through the system. The filter should not get blocked, should be easy to clean and should not allow even minor contaminants into the storage system.

The most commonly available filter system for rainwater harvesting consists of sand and gravel media placed in a container. They are usually made of ferrocement and is fitted to the top of the storage tank. Swetha and Sathian, 2015 have reported that the most important impurity to be removed from rooftop rain water is the organic impurities such as mosses and other small vegetation. The type

of micro mesh filters used in this system have proved to be an alternative to sand and gravel media filter. They also facilitate very easy to cleaning functions besides having good cleaning efficiency (Swatha and Sathian, 2015). At the same time, micromesh filters require further modifications and improvisations to make it more efficient and user friendly. One of the major limitations of this filter system is its requirement of very high periodic cleaning, in order to avoid the foul smell developed due to decomposition of organic impurities in the stagnant water on the inlet side of the micro mesh filter. Hence, an automatic cleaning system for the micro mesh filter system was an immediate necessity. Also, testing of smallest size micro mesh filters are required to evaluate their filtration efficiency and discharge capacity. In this context, this study has been proposed to develop an automatic cleaning mechanism for roof water harvesting and to evaluate different sizes of micro mesh filters with the given below specific objectives.

- To assess the performance of upward flow mesh filters of different mesh sizes under actual rainfall condition.
- To evaluate performance of first flush system under actual rainfall condition.
- To develop an automatic cleaning mechanism for upward flow mesh filter and its evaluation.

CHAPTER 2

REVIEW OF LITERATURE

2.1 RAIN WATER HARVESTING

The earth, which is already under limited water resources is subjected to increasing water demand day by day. Water harvesting is the process of collection and storage of rainwater for domestic, irrigation, livestock and other small scale water needs. It has been practised world over in various forms for centuries, as alternative to limited underground water resources (Environment Agency, 2010). Water harvesting is concerned with broad range of activities which includes rainwater collection from rooftop and surface runoff catchments, rainwater storage in tank and large scale reservoirs and ground water recharge. The objective of water harvesting in most nations is different for urban and rural areas. In urban areas, the main focus is on the managing of the storm water and increasing ground water level. On the other hand, in rural areas, the focus is to provide drinking water and farming. The rainwater harvesting is feasible only when the magnitude and frequency of rainfall and size of the catchment area can generate sufficient water for the intended purpose. Today, rainwater harvesting is recognised as a relatively low cost technology which can be employed to increase the access to clean water. The amount of water harvest depends on duration, frequency and intensity of rainfall, characteristic of catchment and need of water. The literature review presented in this chapter mainly focus on the rainwater harvesting, rooftop rainwater harvesting, purification of rooftop rainwater harvesting and automatic cleaning mechanism for rooftop harvesting.

According to UNICEF and WHO, over 780 million people remain in need of improved sources of drinking water, with 2.5 billion lacking improved sanitation. A variety of environment friendly and sustainable techniques have been developed in response to challenges associated with the provision of clean water supplies. Rain Water Harvesting (RWH) is one such alternative water supply source (UNICEF).

Rajan (2001) conducted a study on rain water harvesting in Indo Gangetic plains of Dihra village in Bihar. Here, the traditional Pyne and Anars have been irrigated using rain water at times, when the zonal canal failed to meet the purpose.

Rana (2002) has conducted a study on rainwater harvesting on three villages of Paikgacha Thana in Khulna district in Bangladesh. Guruikhali union at Khulna district has been taken as the study area because the area has extensive scarcity for drinking water and almost family is engaged in rainwater harvesting. That if RWHS supply water year round to meet the needs of a nuclear family, the demand could not exceed 1000 l per month. The effective management of water resource demands a holistic approach of linking social and economic development with protection of natural ecosystem. Water development and management should be based on the participatory approach involving users, planners, and policy makers at all levels.

Visalakshi *et al.*, (2006) conducted study on rainwater harvesting system in KAU, Trissur. Kerala as a safeguard against water crisis of the campus. The rainwater harvesting structures were made to mitigate the water scarcity problems of the Ladies Hostel of College of Horticulture, Vellanikkara. The excess flow of 2341 m³ was utilized for ground water recharge by providing gravel packed percolation pits of size 2 m diameter, with 2 m depth. Another pond of 1,00,000 l capacity lined with 300 micron geo-membrane and top covered by 75 percent shade net for minimising evaporation losses and preventing entry of debris was also constructed for meeting the irrigation needs of the farm.

Feasibility study of rainwater harvesting techniques in Bangladesh has been reported by Manzurul *et al.*, (2007). The study conducted on the possibility of harvesting water in rural communities of Bangladesh (52 districts) and also in the place of Dhaka, using simple and low cost technology. Bangladesh University of Engineering Technology (BUET) in this monsoon using a small catchment area (15' x 15') made of ferro -cement storage tank having capacity of 3200 l per 15 members' family and proof cloth. The rainwater was stored for 4 months. The research focused at quality aspects of stored rainwater including total solids, total

dissolved solids, colour, hardness, pitch, lead, fluoride, acidity, pH, BOD, COD. The result showed that the stored rainwater had slightly higher pH value (8.1 to 8.3) and existence of coliform bacteria (when water is stored for more than 3 months) also detected.

Domestic rainwater harvesting to improve water supply in rural South Africa was studied by Kahinda *et al.*, (2007). As part of the study, domestic rainwater harvesting, which provide water directly to household enables a number of small scale creative activities, has the ability to supply water even in rural and peri urban areas where the conventional technology cannot supply. The results obtained on this study shows that DRWH appears to be one of the most promising substitute for supplying fresh water in the face of cumulative water scarcity and escalating demand.

The opportunities in rainwater harvesting have been reported by Helmreich and Horn (2008). Depending on precipitation magnitude, rainwater constitutes a potential source of drinking water. They studied and stated that the proper management of RWH could minimise food and water crisis in some of the regions of developing countries. Rainwater harvesting (RWH) is a technique where surface runoff is efficiently collected during rainy season. In order to support such technologies, rain water harvesting systems must be based on local skills, materials and equipment. Harvested rainwater can then be used for rain fed crops or water supply for domestic needs. Unfortunately, rainwater might be polluted by some of the microorganisms like bacteria and hazardous chemicals, necessities treatment before use. The study reported that slow sand filtration and solar technology are the new methods to reduce the pollution. Membrane technology would also be a potential disinfection technique for a safe drinking water supply. In this study they have used three forms of RWH techniques, viz. in situ RWH, external water harvesting, domestic water harvesting.

A study on Rainwater harvesting to alleviate water scarcity in dry conditions was conducted by Shadeed and Lange (2010). To evaluate the potential for rainwater harvesting in arid to semi-arid Faria catchment, in the west bank,

Palestine. Under current conditions, the supply demand gap was increasing due to increasing water demands of a growing population with hydrologically limited and uncertain supply. By 2015, the gap is estimated to reach $4.5 \times 10^6 m^3$. The study used the process oriented and physically based TRAIN-ZIN model to calculate two different rainwater harvesting techniques during two rainfall events. The study shows that there is a theoretical potential for harvesting an additional $4 \times 10^6 m^3$ of surface water above the entire catchment. Thus, it is necessary to manage the potential available surface water supplies in the catchment to store water for water scarcity period (during summer season) when the supply demand gap is comparatively high. Thus, a valuable contribution to bridge supply demand gap can be made.

Agarwal and Sunil (2010) have reported the impact of rooftop rainwater harvesting for groundwater recharge under the Punjab Agricultural University. Under the research study, rainwater harvesting structure was constructed on the rooftop and the filtration unit was designed for groundwater recharge and evaluated for 4 years. The other harvesting structure constructed at the university library recorded an average of 2.08 million liters groundwater recharge per annum. The study report that this technique should be adopted at mass level to get better results.

The system of rainwater collection, storage and pumping has been developed by Constantain *et al.*, (2010). The system was tested in the greenhouses belonging to the research and development station for vegetables growing of Buzau within Academy of Agriculture and Forest Sciences of Bucharest. The design includes a network of rain water collection pipes on the top of the greenhouse, a water collection unit and water pumping unit was tested the quality of water with low salt content was greater than that of the groundwater with a high salt content. The working of system was good and the crop yield was by 9.2% higher when irrigated with rainwater, in comparison with ground water.

The environment agency at Bristol (2010) published an information guide for harvesting rainwater for domestic uses. This document provided the information on rainwater harvesting systems in the UK. It covered the supply of non-potable

water for domestic uses such as cleaning, watering the garden and washing of cloths using the harvested rain water.

Zhe *et al.*, (2010) has reported from the study on rainwater harvesting and greywater treatment systems for domestic application in Ireland. The use of domestic rainwater harvesting and greywater treatment systems has the potential to supply nearly 94% of domestic water in Irish households. The results revealed that the utilization of these systems can help Irish householders succeed substantial water savings and avoid the domestic water bills that are due to be re-introduced. It also helps to relieve the pressure of the centralized water supply to meet the increasing water demand in Ireland and reduces issues such as leakage during distribution and large treatment costs for domestic utilization.

Risk Assessment using risk analysis of rainwater harvesting and Utilization has been reported by Kaposztasova, *et al.*, (2014). Informs about the selected approach of the evaluation methodology verified by hierarchy process. They used RWH system of a small family using risk analysis because their wide implementation and enough information available. Determination of risk score according to semi-quantitative methodology is made to according Risk = likelihood of occurrence \times severity of consequences. The results from the risk analysis were verified by the AHP (Analytical Hierarchy Process) and empirical multi-level comprehensive evaluation.

2.2 ROOFTOP RAINWATER HARVESTING

Rooftop Rainwater Harvesting is the technology through which rain water is captured from the roof catchments and stored in storage tanks. Surplus after storing to the full capacity of the storage tank can be used for ground water recharge, agriculture and domestic uses. The main aim of rooftop rainwater harvesting is to make water available during summer season (dry season). The rainwater collecting and storing from roof is especially important in hilly, coastal, dry land and urban areas. As the rooftop is the main catchment, the quality and quantity of rain water collected depends on the type of roofing materials and its

area. The roofs constructed with RCC slab, aluminium or asbestos cement sheet, galvanized corrugated iron, tiles and thatched materials, can deliver pure rain.

The evaluation of the rooftop rainfall collection using cistern storage systems in southwest Virginia has been reported by Tamim *et al.*, (1998). The main objective of this study was to gather information about cistern use, properties, and management in the isolated communities of southwest Virginia. The survey indicated that more than 30 % of the households in the surveyed areas depend on cisterns for their drinking water needs, and that 20 % of the cisterns run dry at least once a month.

Jyothison *et al.*, (2002) conducted a study on the assessment of roof water harvesting potential and recharge pit design in KCAET Tavanur, Malappuram, Kerala. They found out the infiltration and seepage rate of the soil of that area and also conducted the permeability tests. They calculated the size of recharge pit for different roofs in KCAET from the results obtained.

Dinesh (2004) conducted a study on the roof water harvesting for domestic water security has reported that hydrological opportunities for RWHS are very poor in urban and rural areas and it may be economically sustainable as a supplementary source to existing public water supply schemes. The study analysed the physical possibility, scope and economic viability of roof water harvesting systems across different physical and socio economic classes of the society. The article states that roof water harvesting systems (RWHS) are not an alternative to public systems in urban and rural areas receiving low rainfall.

Dwivedi and Bhadauria (2004) have conducted a study based on the analysis of survey record of around 50 houses having different sizes of rooftop of urban area of Dhule town. The estimation of the approximate size of the water tanks and their costs required to fulfil the annual drinking water need through Domestic Rooftop Water Harvesting (DRWH) from rooftops of different areas were done. As a part of their work the DRWH systems for all houses was designed considering the existing rain water outlets and cost estimation for each individual house was also

done. A mathematical equation expressing the relationship between the required size of water tank and different rooftop areas was developed as given below.

$$C_D = 3265 \times \ln(A) - 6462$$

Where; C_D = Cost of DRWH System in Rupees and A = Rooftop Area in m^2 .

The effect of weather on the microbial composition of roof harvested rainwater study was conducted by Evans *et al.*, (2006). They studied analysis of direct roof runoff at an urban housing development in Newcastle, on the east coast of Australia. A total of 77 samples were collected through 11 separate rainfall events, and microbial counts and mean concentrations of several ionic pollutants were matched to climatic data corresponding to each of the monitored events. The results indicated that the aerobic microorganisms represented a significant contribution to the bacterial load of roof water at this site, and that the overall contamination was influenced by wind velocities.

Shivakumar (2006) of Karnataka State Council for Science and Technology (KSCST) took up a research work on rainwater harvesting from rooftops. They made a rain water harvesting system and studied roof area calculation for different roofs, storage and filtering systems used for this purpose.

Sharma (2007) has conducted a study on the roof water harvesting at Delhi and has reported that the water supply of the city is under tremendous stress due to the over exploitation of ground and as a result, the water table was declining at an alarming rate. However, Delhi is blessed with an average annual rainfall of about 100 cm, and the response of abundant building structures and Group Housing creates huge roof water potential. A dwelling unit with a rooftop area of $150 m^2$ in a total land area of $900 m^2$ in Kishangarh in East Delhi, where six adult persons reside was selected for the implementation of the scheme of rooftop rain water harvesting. It has been found that rainwater harvesting is the most suitable method for supplementing groundwater level artificially in the area where natural recharge is considerably reduced due to improved urban activities and not much of land is available for implementing any other artificial recharge measures.

Roof catchments should be cleaned regularly to remove leaves, dust, bird droppings so as to maintain the quality of roof water. The amount of water that is received in the form of rainfall over an area is called the rain water endowment of the area. The available amount that can be effectively harvested is called the water harvesting potential. The runoff coefficient in the case of roofs vary from 0.7 to 0.9 with the type of roofing materials. Rainwater harvesting usually involves capturing water from cleaner surfaces, such as roofs. Most of the rainwater collection systems are cost effective and easy to maintain by the average house owner and are easier to install than surface ponds or wells (Thomas and Martinson, 2007).

Water harvesting as an effective tool for water management study was conducted by Rishab *et al.*, (2007). The various forms of water harvesting have been elucidated. The common goal of all forms was to secure water supply for pastures, trees, annual crops and animals in dry areas without tapping groundwater or river-water sources. As the appropriate choice of technique depends on the land topography, soil type, amount of rainfall and its distribution, local socio-economic and soil depth factors. These systems, it is stated, tend to be very site specific. The water harvesting methods adopted strongly depend on local conditions and include such widely different practices as pitting, bunding, micro catchments water gathering, flood water and ground water harvesting.

Brock and Kate (2008) carried out a study on a “low impact” roof water harvesting system in Brazil. They used the term “low impact” to define this system because it models the design thoughts of Low Impact Development which is a storm water management approach with a simple principle that is modelled after nature manage rainfall at the source using equally circulated decentralized micro-scale controls and mimic a site's predevelopment hydrology by using design techniques that evaporate, infiltrate, store, filter and detain runoff close to its source. The result was a hydrologically functional landscape that creates less surface runoff, less pollution, less erosion, and less overall damage to lakes, streams, and coastal waters.

Rejuvenation of water bodies by adopting rainwater harvesting and groundwater recharging practices in catchment area under the Central Plantation Crops Research Institute (CPCRI), in Kasaragod, Kerala has been reported by Manoj and Mathew (2008). The studies suggested that these technologies are sustainable, cost-effective, locally adoptable and reasonable to the agriculturalists. This study also discovered that the rejuvenation of the traditional water harvesting structures in the district and the application of community water management organisations with maximum people's participation are the suitable options to mitigate all the ill effects of drought and soil erosion prevalent in the area.

A study conducted by Fayez *et al.*, (2009) in Jordan describe roof rainwater harvesting systems for household water supply. The objectives of this study was to (1) provide some suggestions and recommendations regarding the improvement of both quality and quantity of harvested rainwater and (2) evaluate the potential for potable water savings by using rainwater in residential sectors of the 12 Jordanian governorates. Results showed that a maximum of 15.5 Mm³/year of rainwater can be collected from roofs of housing buildings provided that all surfaces are used and all rain falling on the surfaces is collected. That was equivalent to 6% of the total domestic water supply of the year 2005.

Beckman and Devine (2011) of National Research Development Corporation (NRDC) reported a research work on capturing rainwater from rooftops at different places of United States. The analysis evaluated the available daily rainfall and conservatively estimated non-potable water demands to determine reasonable projections for the amount of potable water demand that could be replaced by using rainwater for eight selected U.S. cities. To determine the available amount of rooftop rainwater that could be captured in each of the cities, GIS data were used to identify the total land area of residential and non-residential roofs.

Reena and Sherring (2012) conducted a study on planning and cost estimation of roof rainwater harvesting structure in Allahabad Agricultural Institute, a Deemed University, to find the possibility of rainwater harvesting from the roof of Biotechnology Building. For this study, the last ten year daily rainfall

(rainy season) data was analysed and upcoming rainfall was expected with 75 percent probability limit. The estimated rainfall at 75 percent probability limit of rainfall was 547.8 mm with recurrence interval of 1.33 years. The four month rainfall of June to September was considered to estimate the runoff from the roof top. The design dimensions of the reservoir was estimated as 12 m x 10 m x 3.05 m with the storage capacity of 366 m³ and the cost of storage of harvested water was estimated as 0.1 rupees per litre.

The reevaluation of health risk benchmark for sustainable water practice through risk analysis of rooftop harvested rain water study was conducted by Ying Lim *et al.*, (2013). In their study, they challenged the current benchmark of risk by quantifying the potential microbial load associated with consumption of roof harvested rain water. Results showed that the 95th % values of infection risk per intake event of home produced roof water are one to three orders of magnitude (10^{-7} to 10^{-5}) lower than US EPA risk benchmark (10^{-4}). They further discussed the desirability of HRW for irrigating home produced food crops. Further, the study proposed the need of an updated approach to assess appropriateness of maintainable water practice for making guidelines and policies.

Chandel and Sharma (2014) A study conducted on Potential limits of Domestic Rooftop Water Harvesting in Una Area of Shiwalik Hills. The paper is based on the analysis of survey record of 40 houses of different roof areas of shiwalik hilly region in Una district of Himachal Pradesh in India. As a part of study rainwater harvesting is a solution for water problem areas, particularly in hilly areas where the ground water level is low and the surface sources less and too found at very low elevation in the valleys. Rainwater harvesting is of help to solve the water shortage and the problem can be eliminated to a large extent. Rainwater is pure from organic matter and soft. The water has to be pumped to a high elevation where the habitations are found. The rainwater collected from rooftops can be stored in a tank and can be used directly. It can be used secondarily by diverting it to recharge the aquifer. Though Himachal Government is providing piped drinking

water supply to all of its population in the state, yet there are areas which face acute shortage of water during dry months.

2.3 PURIFICATION METHODS OF ROOF HARVESTED RAINWATER

Water purification is the process of removing biological pollutants, unwanted chemicals, gases and suspended solids from polluted water. The main objective of this process is to produce water fit for a particular purpose. Most water is sanitized for human consumption (drinking water) but water purification may also be done to meet the requirements of medical, pharmacological, chemical, industrial and other applications. The quality of rain water can be improved by simple purification methods. Generally, the methods used include physical processes such as distillation, sedimentation, filtration and biological processes such as slow sand filters, chemical processes such as chlorination and flocculation and the use of electromagnetic radiation such as ultraviolet light. Water purification process may reduce the concentrations of suspended particles, algae, parasites, bacteria, viruses, fungi and a range of liquefied and particulate material derived from the surfaces with which rain has interacted (Yaziz *et al.*, 1989).

2.3.1 Chlorination

Chlorine can be applied for the deactivation of most microorganisms and it is quite cheap. Chlorination is the addition of chlorine to water and it has to be applied after removal of the harvested rainwater from the storage container (tank), because chlorine may respond with organic substance which is settled to the bottom of the tanks and form undesired by-products. The amount of free chlorine in Chlorination must be within the range of 0.4–0.5 mg/l and can be done by chlorine gas or chlorine tablets. The limitation of disinfection by chlorination is that some parasitic species have shown resistance to low chlorine doses. Chlorination to kill bacteria is widely recommended as a sterilization for rainwater collection systems. But generally chlorinated water is not well liked by users and the chemicals used can be dangerous if misused. Chlorination of the water tank is recommended only where one or more of the following situations are present due to the above cited disadvantages of chlorination (Krishna *et al.*, 2014).

- A known bacterial risk has been identified through water testing
- People are getting sick as a result of drinking the water
- It is not feasible to completely empty a tank for cleaning
- An animal or faecal material has entered in to the tank

The addition of chlorine to disinfect water can virtually eliminate waterborne diseases such as dysentery, typhoid, hepatitis and cholera saving the human lives. To reduce the possibility of harmful by-product after the use of chlorine, the following methods are suggested (Rebeix *et al.*, 2014).

- Remove the by-products after they have been formed. This is expensive, compared to other purification systems (e.g., reverse osmosis or other purification systems).
- The concentration of particulates/organisms in the water need to be removed before it is treated. This is accomplished by using filters to eliminate these substances from the water prior to chlorine treatment.

2.3.2 Ultraviolet Light

Ultraviolet (UV) light is an alternative for disinfecting water. In Europe UV lights have been used for nearly a century and are now common in the US. In his method of purification the water must always pass through a filtration system first, with UV lights. Whenever a filter is not used, pathogens and bacteria will cast shadows in the flowing water, thereby permitting live organisms to pass through uninjured. (Wolfe, 1990). UV light penetrates an organism's cell walls and disrupts the cell's genetic makeup, makes it impossible to reproduce and renders it harmless. When UV lights used there is no change in the chemical composition of water, thereby no by products are produced. For UV to be effective, the correct light dose should be used to an exact unit of water and the water must be clear of suspended solids and other particulates. UVA radiation inactivates microorganisms by damaging proteins and producing hydroxyl and oxygen radicals that can abolish cell membranes and other cellular components (Bolton *et al.*, 2008). Demonstrated

the capacity of UVA-LEDs at 365 nanometre to deactivate bacteria in water. They found that *E. coli* were reduced by greater than 5 log at a dose of 315 J/cm².

2.3.3 Membrane filtration

Wide usage of membrane filters are there in the filtration of both drinking and sewage water. For drinking rainwater, membrane filters can eliminate almost all particles of size greater than 0.2 µm including giardia and cryptosporidium. Membrane filters are an effective form of tertiary action when it is desired to reuse the water for industry, for domestic purposes, or before diverting the water into a river that is used by towns further downstream. In industry they are widely used for beverage preparation (including bottled water). However no filtration can remove dissolved substances such as nitrates, phosphorus and heavy metal ions. Membrane filtration involves pushing water through a layer of material. Pressure-driven membrane technologies include microfiltration, ultrafiltration, nano filtration and reverse osmosis (Vanreis and Zydney, 2007). It is able to remove pharmaceuticals, and creates no by-products. Membrane technologies are more costly when compared to others, but prices are on the decline.

2.3.4 Solar pasteurization

Solar pasteurization technique involves the combination of ultraviolet radiation and the heat from solar energy. This is a reliable and low-cost treatment method. The harvested water can be pasteurized by placing it in plastic bottles or bags. This method is most effective when water temperature raises up to 50 °c and the water is totally oxygenated. Solar pasteurization is very effective against *E. coli* and other pathogenic bacteria. However this method has limitation when the concentration of suspended solids is greater than 10 mg/l. Solar pasteurization may be utilized for adulterated water sources as microbes are susceptible to heat (pasteurization) and ultraviolet-A radiation. (Zhe *et al.*, 2010).

2.3.5 Distillation

Distillation is the last commonly available purification technology. It separates the water from the impurities through water heating and then gathering

the condensation. It is very energy intensive and about 5-10percentage of the water is lost due to evaporation. Except volatile organic chemicals, distillation removes almost all substances from the water. In some distillation systems, carbon filters are used to remove the volatile organic carbons. The working of distillation system is slow in order to decrease energy requirements and will store the purified water in a tank for later use (Jain *et al.*, 2015). It will eliminate heavy metals, salts, and other chemical pollutants. Basically, the process involves boiling water so that it leaves behind all the junk that has contaminated it, and then collecting the vapour and allowing it to condense back into liquid water (Kahinda *et al.*, 2007). A simple distilling apparatus can be created simply by suspending a cup by attaching it to the inside of a large pot's lid, and then putting a layer of water in the bottom of pot and boiling it for twenty minutes. As the pot cools then, the water that drips down into the cup is purified.

2.3.6 Filters

A filter is used to separate suspended pollutants from rainwater collected from roof. Filters are measured in microns. The filter unit is a chamber filled with filtering media such as fiber, coarse sand and gravel layers to remove debris and dirt from water before it enter the storage tank or recharge structures. Effective removal of turbidity, colour and microorganisms can be done by using filters. After first flushing of rainfall, water should pass through filters. Charcoal, sand and micromesh filters are commonly used. Charcoal filter can be made in a drum or a sand pot. The filter is made of sand, charcoal, and gravel, all of which are easily available. The sand filters have generally available sand as filter media, Sand filters are easy and the construction cost is low (Rangwala, 2003). In a simple sand filter, that can be created locally, the top layer comprises coarse sand followed by a 5-10 mm thickness of gravel and next 5-25 cm layer of gravel and boulders.

The micro-mesh screen can filter debris in the 80-100 μ size which is beneficial for potable or indoor fixture systems which require superior filtration. The screening stage stops debris and large particles from going into the rainwater storage tank (Thomas *et al.*, 2004). Rainwater collected from the rooftops and

stored in tanks hardly meets quality levels for human consumptions. But, it can be directly used for showers, washing machines, gardening and other non-consumptions

2.4 ROOF HARVESTED RAINWATER QUALITY

The rain water quality refers to the physical, chemical, biological characteristics of the rain water. Water may be used for different requirements such as, agricultural, fisheries, industries and domestic purposes. The rain water is relatively pure, when they falls on the ground surface, during harvesting time and storage they get deteriorated due to impurities mixing with the rain water like, leaves, dust, dirt, fecal dropping from the birds, insects and presence of litter on the catchment areas leading to the health hazards. Poor hygiene in stored water in tanks or from point of use can also indicates the health concern. However, these water should be free from causing hazards to health and to minimize health hazards good hygiene should be maintained. Well designed rainwater harvesting systems with cleaning periodically catchments, storage tanks its shows good hygiene, at point of view these water can be used for drinking purpose, it will reduce causing of health hazards.

Microbial contamination of harvested and collected rainwater indicated by *E. coli* is quite common, mainly in samples collected shortly after rainfall. The Pathogens such as campylobacter, giardia, cryptosporidium, Salmonella, Vibrio, Shigella and Pseudomonas have also been identified in rainwater (Crabtree *et al.*, 1996). If water testing quality is possible, the focus should be mainly on the microbiological testing using some of the tests such as Enterococci, simple H₂S test and fecal coliforms. According to World Health Organization guidelines (WHO, 1996) the fecal bacteria should not be detectable per 100 ml of rainwater sample. Fujioka 1997 states that the more realistic standard may be 10 fecal coliforms/100 ml. Many recent studies have used thermo tolerant coliforms and *E.coli* as indicator organisms to predict the occurrence of pathogenic organisms. There were no correlation between thermo tolerant coliforms and the presence of *E.coli* or there were no pathogens present when thermo tolerant coliforms were

detected. On the other side, the absence of thermo tolerant coliforms does not indicate the absence of cryptosporidium and giardia spp. (Gadgil, *et al.*, 1998). If treatment of water is undertaken, thermo tolerant coliforms could be destroyed but high resistant organisms like giardia spp. and cryptosporidium can survive (Despins *et al.*, 2009).

The permissible limit of various water quality parameters based on different standards is given below (Table 2.1 and Table 2.2).

Table 2.1 Quality parameter with different standards

Quality parameter	Standard		
	WHO	BIS 10500 2012	EPA
pH	6.5-8	6.5-8.5	6.5-8.5
Turbidity (NTU)	5	1-5	--
Colour (Hazen unit)	15	15	15
Odour	Agreeable	Agreeable	3 threshold odour numbers
Total dissolved solids(mg/l)	1000	500	500
Total suspended solids(mg/l)	--	--	600
Conductivity (μ mhos/cm)	600	--	--
Chloride (mg/l)	250	250	250
Copper(mg/l)	2	0.05	1
Zinc(mg/l)	3	5	5

Table 2.1 continued

Iron(mg/l)	0.3	0.3	0.5-50
Manganese(mg/l)	0.5	0.1	0.05
Lead (mg/l)	0.01	0.01	0
Total hardness (mg/l)	100	600	--
Total coliforms (no. /100ml)	0	0	0

Table 2.2 WHO's drinking water standards for organic compounds

Group	Substance	Formula	Health based guideline by the WHO
Chlorinated alkanes	Carbon tetrachloride	C Cl ₄	2 µg/l
	Dichloromethane	C H ₂ Cl ₂	20 µg/l
	1,1-Dichloroethane	C ₂ H ₄ Cl ₂	No guideline
	1,2-Dichloroethane	Cl CH ₂ CH ₂ Cl	30 µg/l
	1,1,1-Trichloroethane	CH ₃ C Cl ₃	2000 µg/l
Chlorinated ethenes	1,1-Dichloroethene	C ₂ H ₂ Cl ₂	30 µg/l
	1,2-Dichloroethene	C ₂ H ₂ Cl ₂	50 µg/l
	Trichloroethene	C ₂ H Cl ₃	70 µg/l
	Tetrachloroethene	C ₂ Cl ₄	40 µg/l

Table 2.2 continued

Aromatic hydrocarbons	Benzene		C ₆ H ₆	10 µg/l	
	Toluene		C ₇ H ₈	700 µg/l	
	Xylenes		C ₈ H ₁₀	500 µg/l	
	Ethylbenzene		C ₈ H ₁₀	300 µg/l	
	Styrene		C ₈ H ₈	20 µg/l	
	Polynuclear Aromatic Hydrocarbons (PAHs)		C ₂ H ₃ N ₁ O ₅ P _{1 3}	0.7 µg/l	
Chlorinated benzenes	Monochlorobenzene (MCB)		C ₆ H ₅ Cl	300 µg/l	
	Dichlorobenzenes (DCBs)	1,2-Dichlorobenzene (1,2-DCB)	C ₆ H ₄ Cl ₂	1000 µg/l	
		1,3-Dichlorobenzene (1,3-DCB)	C ₆ H ₄ Cl ₂	No guideline	
		1,4-Dichlorobenzene (1,4-DCB)	C ₆ H ₄ Cl ₂	300 µg/l	
	Trichlorobenzenes (TCBs)		C ₆ H ₃ Cl ₃	20 µg/l	
Miscellaneous	Di(2-ethylhexyl)adipate (DEHA)		C ₂₂ H ₄₂ O ₄	80 µg/l	
	Di(2-ethylhexyl)phthalate (DEHP)		C ₂₄ H ₃₈ O ₄	8 µg/l	
organic constituents	Acrylamide		C ₃ H ₅ N O	0.5 µg/l	
	Epichlorohydrin (ECH)		C ₃ H ₅ Cl O	0.4 µg/l	
	Hexachlorobutadiene (HCBD)		C ₄ Cl ₆	0.6 µg/l	
	Ethylenediaminetetraacetic acid (EDTA)		C ₁₀ H ₁₂ N ₂ O ₈	200 µg/l	
	Nitrilotriacetic acid (NTA)		N(CH ₂ COOH) ₃	200 µg/l	
	Organotins	Dialkyltins		R ₂ Sn X ₂	No guideline
		Tributyl oxide (TBTO)		C ₂₄ H ₅₄ O Sn ₂	2 µg/l

2.5 EFFECT OF ROOFING MATERIAL ON THE QUALITY OF RAINWATER

Susumu *et al.*, (2001) have conducted a study on physicochemical speciation of molybdenum in rain water. In this research, a combination of a sensitive catalytic determination method with ultrafiltration and filtration have been used for the physicochemical speciation of molybdenum in synthetic and natural rain water samples. They revealed that the traces of molybdenum in the succeeding rainfall sample were found in a fraction with smaller molecular weights <103 Da and characterized as labile forms, i.e. simple molybdate ions.

A study by Hengren *et al.*, (2004) on the urban water quality using artificial rainfall in South-East Queensland, Australia, US. They described how artificial rainfall, using a specially designed highly portable rainfall simulator was engaged in order to create water quality data from urban environments. The study reported that the rainfall simulator is a reliable tool for urban water quality research and can be used to simulate pollutant wash-off.

A study on treatment of rainwater quality using sand filter by Rahmat *et al.*, (2008) has been reported. The Study focused on Rainwater Harvesting System that is placed at UTHM main campus in Batu Pahat, Johor and its suitability in terms of water quality. The system consists of rooftop, gutters, storage tank and sand filter as a treatment system. 12 samples (influent and effluent) from six storm events were evaluated. Concentrations for all parameters were found to vary significantly between storms. Elimination percentages were then calculated and the values (%) were DO (9-16), Turbidity (61-76), pH (10-16), Copper Plumbum (15-53), and suspended solids (19-54), respectively. Lead (Pb) was also identified but the levels were less (<0.001 mg/l). Based on the results, sand filter has the potential to be a practical and cost effective technique of treating impurities for harvested rainwater. The important findings on the treatment of harvested water quality is that the sand filter can be filtered successfully and removed some of the pollutants.

The quality of harvested rainwater was reported by Ward *et al.*, (2010). The physicochemical and microbiological quality of water from rainwater harvesting (RWH) system in a UK based office building was tested. Seven microbiological

and thirty-four physiochemical parameters were evaluated during a period of 8 months. Physiochemically, quality of harvested rainwater posed little health risk; most parameters showed concentrations below widely accepted levels for drinking water.

The effect of roofing material on the quality of harvested rainwater a studied has been by Mendez *et al.*, (2011). They studied and stated that the effect of conventional roofing materials (Galvalume metal, concrete tile and, asphalt fiberglass shingle,) and alternative roofing materials (cool and green) on the quality of harvested rainwater. The results from pilot-scale and full-scale roofs confirmed that rainwater harvested from any of above roofing materials need treatment. At least, filtration, disinfection and first-flush diversion are suggested. Metal roofs are generally suggested for rainwater harvesting applications, and this study indicated that rainwater harvested from metal roofs have lesser concentrations of fecal indicator bacteria as related to other roofing materials. However, concrete tile roofs produced harvested rainwater quality related to that from the metal roofs, representing that concrete tile roofing materials also are appropriate for rainwater harvesting applications. The concentrations of some metals (arsenic) in rainwater harvested from the green roof recommended that the quality of commercial growing media should be carefully inspected if the harvested rainwater is being considered for domestic use. Hence, roofing material is a significant consideration when deciding a rainwater catchment.

Roof selection for rainwater harvesting in the content of quantity and quality assessments in Spain has been reported by Farreny *et al.*, (2011). The roofs are the primary candidates for rainwater harvesting in urban regions. This study integrates quantitative and qualitative data of rooftop storm water runoff in an urban Mediterranean- weather atmosphere. The main objective of this research was to provide criteria for the roof selection in order to maximise the accessibility and quality of rainwater. Four roofs have been selected and examined over for two years period (2008-2010): 3 sloping roofs of metal sheet, clay tiles and polycarbonate plastic and one flat gravel roof. A model was used for the calculation of the runoff

volume and the preliminary abstraction of each roof, and measure the physicochemical pollution of roof runoff. The differences in the runoff coefficients (RC) are observed, which depends commonly on the roughness and slope of the roof. The results have important significance for urban planners and local governments in the design of buildings and cities from the perspective of sustainable rainwater management.

Lee *et al.*, (2012) conducted a study on the comparison of Quality of roof-harvested rainwater of different roofing materials. The objective of the study was to evaluate the quality of harvested rainwater on the basis of the roofing materials used and the occurrence of lichens or mosses on the roofing surface. Four pilot structures with different roofing materials (clay tiles, wooden shingle tiles, galvanized steel and concrete tiles) were mounted in a field. The galvanized steel was found to be the maximum appropriate for rainwater harvesting applications, with their resulting chemical and physical water quality parameters meeting the Korean recommendations for drinking water quality (pH (5.8-8.5), TSS <500 mg/l, Zn < 1 mg/l, NO₃ < 10 mg/l, Pb < 0.05 mg/l, Al < 0.2 mg/l, Fe < 0.3 mg/l, Cu < 1 mg/l, and E. coli (No detection)). In the case of galvanized steel, the moderately high water quality collection was probably due to the ultraviolet light and the high temperature effectively purifying the harvested rainwater. It was also found that the occurrence of mosses and lichens may harmfully affect the physical, chemical and microbiological quality of rainwater.

Taher (2014) conducted a study on the quantity and quality considerations of rooftop rainwater harvesting as a substantial resource to face water supply shortages. It is the potentiality of rainwater harvesting for use in the city of Sana'a to overcome the present water scarcities, to decrease the overexploitation of groundwater and to reduce the costs people spent for consuming water from either local water authorities. Calculation of surface area was done by building out maps out of Google Earth taking several raster data sets as a picture of the specific scene. The overall surface area was calculated to be 60.3 km². Results show that the estimated amount of water that can be harvested annually from rooftops of Sana'a

City is 11.72 Mm^3 using a runoff coefficients of 0.80, if all surfaces of rooftop are used. It shows a 20% potential annual water savings (PWS) of a total water supplied by sanitation authority and Sana'a local water supply and 59 Mm^3 of water supply by the private providers to the city annually. However, considering supply of 27 Mm^3 to the city by the private providers, a 43.4% PWS (potential annual water savings) can be saved by households. The samples collected from the rooftops are tested, which indicates the safe use of rooftop rainwater when some cleanliness measures are implemented including regular cleaning of surface, first flush system, filtration and chlorination of stored water. This can be applied in the areas of similar drought condition.

CHAPTER 3

MATERIALS AND METHODS

The detailed description of the study area, design, construction and evaluation of various micro mesh filters and development of automatic cleaning mechanism for roof water harvesting system are described in this chapter.

3.1 STUDY AREA

Development of an automatic cleaning mechanism for roof water harvesting system and its evaluation has been conducted on the various micro mesh filter in the campus of Kelappaji College of Agricultural Engineering and Technology (KCAET), Tavanur, Malappuram Dt, Kerala, India. The Geographical reference of the study area is 10° 51' 20" N latitude and 75° 59' 5" E longitude. The average annual rainfall of the study area for the last 25 years is 294 cm. In south west monsoon (June to September), 75% of the annual rainfall is received by the area the balance 25% of rainfall is received during north east monsoon (October to November) and summer rains (December to May). Summer rains are usually very low with a typical variation of 0-5 %. The Climate is humid tropic with a mean annual maximum temperature of 30°C, minimum temperature of 23.5°C and relative humidity 75 %. Major water scarcity of the region arises during the 3 summer months (March to May) due to the prolonged summer season and negligible summer showers.

3.2 COLLECTION OF DIRECT RAINFALL

Direct rainfall samples of the study region have been collected during the period from October 2015 to July 2016. Rainfall samples were collected from an open terrace and stored in 250 ml plastic bottles for analysis. These samples were collected to have a clear understanding on the direct rainfall quality as it pass through the atmosphere. This is useful to evaluate the roll of roofs in incorporating impurities to roof water harvesting system.

3.3 DESCRIPTION OF THE MICRO MESH FILTERS

The micro mesh filter was an upward flow type, constructed using PVC pipes of diameter 90 mm as casing pipe and the stainless steel micromesh wound on 50 mm slotted PVC as filter element, which is placed inside the casing pipe. The filter element is hung concentrically inside the casing pipe and fixed to the casing by means of threaded end cap. Filter element can be taken out from the casing pipe for cleaning by loosening the threaded end cap. A back wash cleaning provision for the filter unit was also provided at the bottom. Height of the filter element was 30 cm. Filter elements for micro mesh filters were made by using different mesh sizes. The total height of filter unit with casing was 75 cm. Design and arrangement of the micro mesh filter is shown in the fig. 3.1

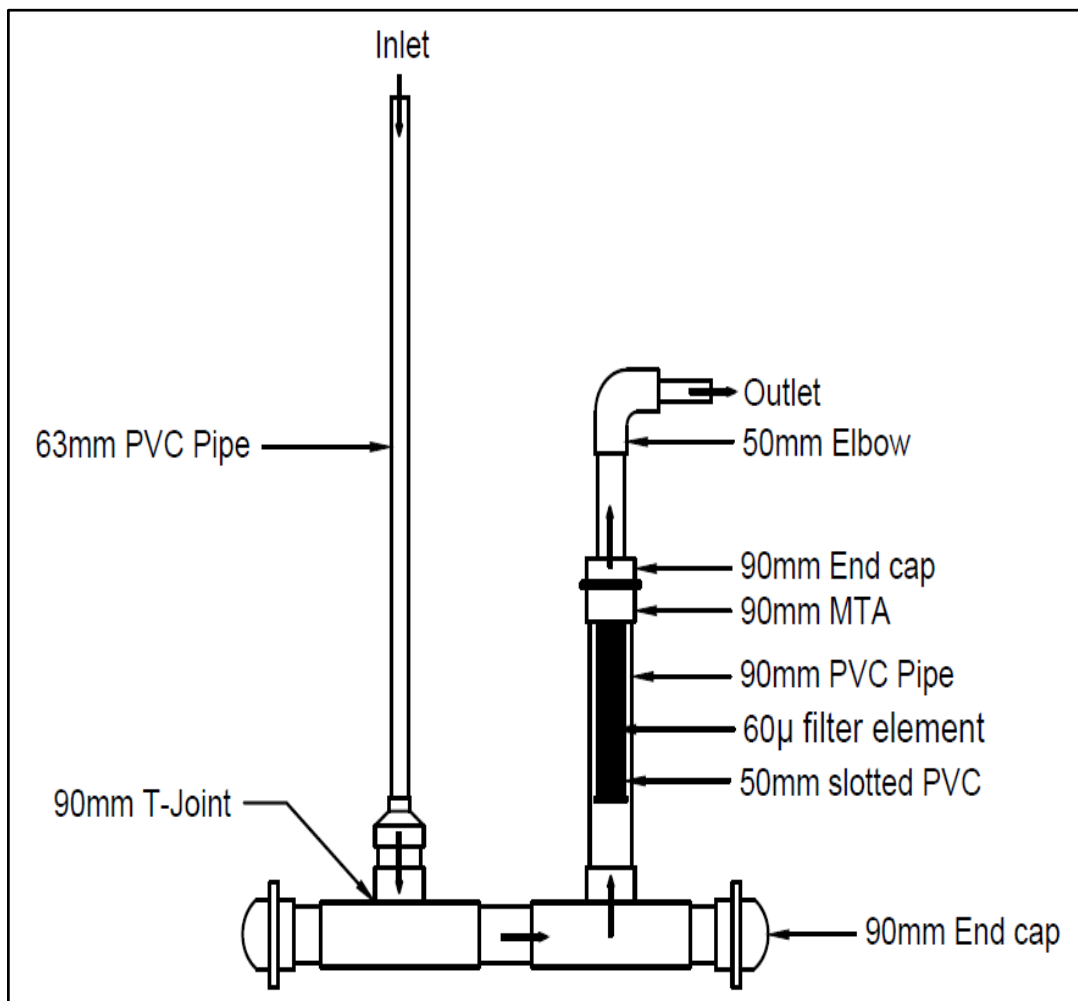

Fig. 3.1 Sectional view of the upward flow micro mesh filter system

3.4 DEVELOPMENT OF UPWARD FLOW MICRO MESH FILTER SYSTEM AND MESH FILTERS

The study includes the development of 60 μ , 40 μ , 25 μ , 15 μ , 12 μ , 7 μ , 5 μ and 3 μ mesh filters. In all cases the micro meshes used were made of stainless steel of grade 316. To make the filter element, 50 mm PVC pipe of 30 cm length is taken and slots of 5 mm ϕ were made on it at an approximate spacing of 15mm centre to centre in the case of all filters except for 40 micron mesh filter. Number of holes in these filters vary from 196 to 230. Mesh area and slot area of different filter elements are shown in the Table 3.1.

Table 3.1 Mesh area and slot area of different filter elements

Mesh size (μ)	Mesh area (cm^2)	No. slots	Slot area (cm^2)
60	447.45	229	44.96
40	447.45	124	24.35
25	447.45	196	38.48
15	447.45	230	45.16
12	447.45	230	45.16
7	447.45	230	45.16
5	447.45	230	45.16
3	447.45	230	45.16

The sectional view of the filter elements are shown in Fig 3.2. The filter elements were fitted in a casing pipe of 90 mm ϕ PVC. With the help of threaded end cap, the unit is made easily detachable to the filter assembly as of the existing filter unit. Developed Automatic cleaning mechanism for upward flow micro mesh filter system is provided at the bottom of the filter unit. The automatic cleaning mechanism developed for upward flow micro mesh filter system are shown in Fig. 3.3

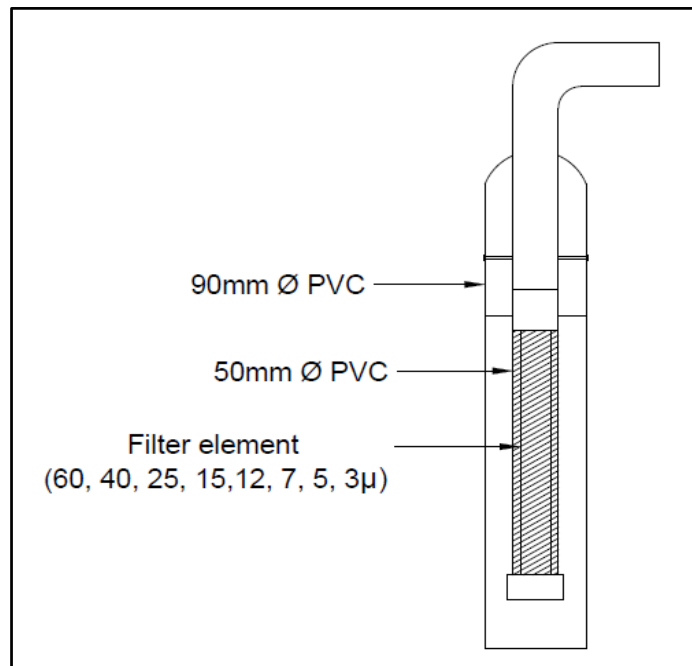

Fig. 3.2 Sectional view of micro mesh filter element

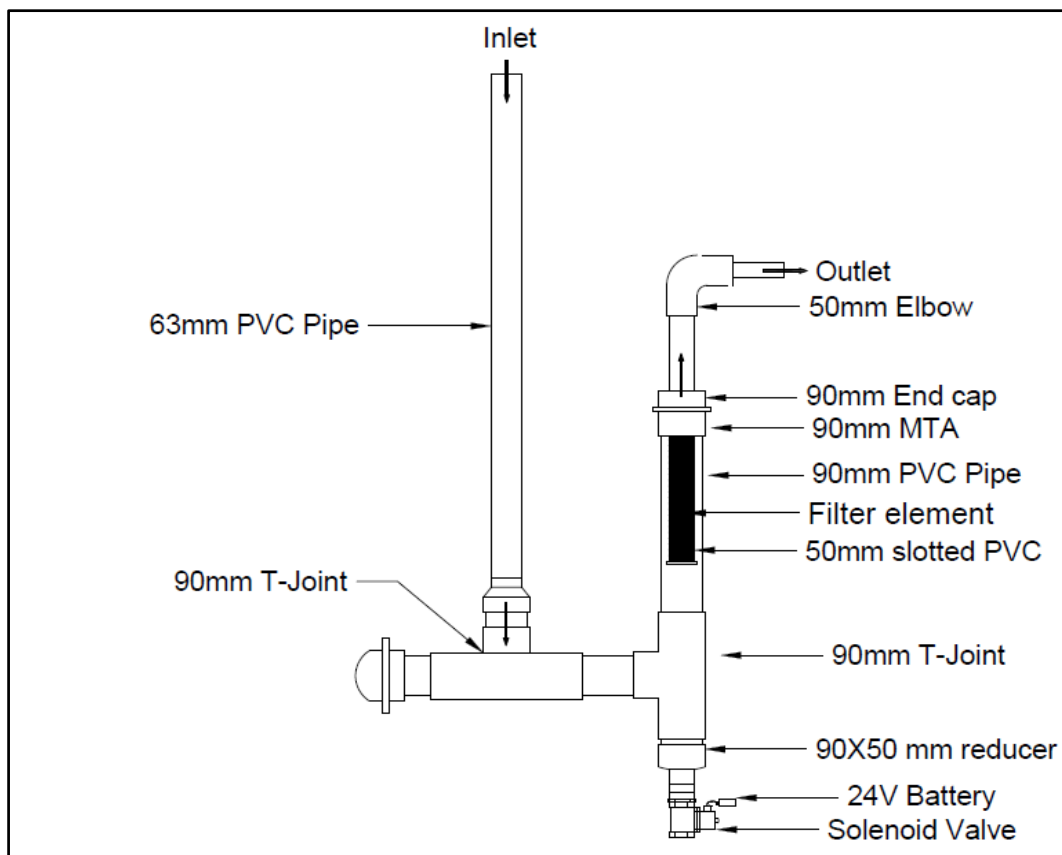

Fig. 3.3 Upward flow micro mesh filter with automatic flush

3.5 DESIGN AND DEVELOPMENT OF FIRST FLUSH SYSTEM

The first flush or foul flush unit aims to divert or bypass the impurity laden rainwater collected from the rooftop. The impure water initially collected by a rainwater harvesting system is known as the “first flush” or “foul flush”, and is the main source of contamination in any rooftop rainwater harvesting system. The main components of the first flush are a floating ball valve in a chamber made up of PVC pipe. The first flush system was constructed using 160 mm diameter PVC pipe which acts as a storage unit for the first rainfall runoff from the top of the roof temporary.

The removal of initially contaminated roof water is the main focus of any first flush system. The first flush is connected to the conveyances pipes from the roof before the filtering unit, using the PVC connectors and reducers. The total capacity of the first flush system is 20 l. Bottom of the first flush chamber is closed by PVC end cap. When the first runoff rainwater from the rooftop is filled up to the maximum capacity of the system, the floating valve will close the chamber from the conveyance pipe and prevent the mixing of the first runoff rainwater with the relatively more pure later coming water. The common initial contaminants in the roof top water will be dust, dirt, leaves, bird droppings, dead insects, and other particulate matter.

The sectional view of the first flush system is shown in the Fig.3.4. The total capacity of the system has been fixed based on the volume of roof runoff water corresponding to a 1 mm initial rainfall. The capacity of the first flush chamber is made as 20 l, so as to make it suitable for 20 m² roof catchment, which is suitable from the point of any domestic roof water harvesting system in Kerala. A small dripper hole is provide at the bottom of the first flush system so that the chamber becomes empty before the next incoming runoff rainfall. The system help to reduce the impurities going to interact with the mesh filter.

Removal of this initially collected roof water is important as it collects the impurities present in the atmosphere and all kinds of contaminants present in the roof and gutter system. Impurities floating in the air could be dust particle.

Contaminants on the roof will be dust, dead leaves, animal excreta, dead insect and other particulate matter. Studies have shown a tremendous drop in faecal bacteria levels when the roof is flushed before water enters the storage tank. Bacteria also like to live in decaying leaves and other organic matter that collects at the bottom of the first flush tank. A first flush diverter facilitates a reasonable level of cleaning of the roof and gutters, so there is less rubbish on the roof and in turns to the storage tank.

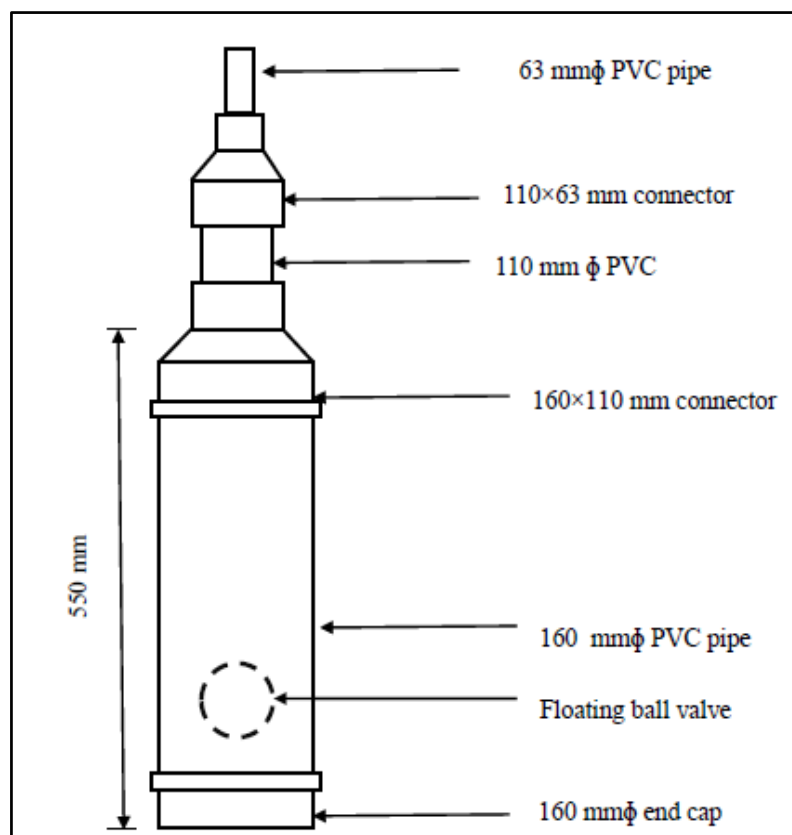

Fig. 3.4 Sectional view of the first flush system

3.6 PERFORMANCE EVALUATION OF THE MESH FILTER

The existing 60, 40 and 25 micron mesh filters and the newly developed filters of mesh size 15, 12, 7, 5 and 3 microns were systematically tested under simulated and actual rainfall condition. Conducting the experiment under actual rainfall condition was practically not possible due to the irregular nature of rainfall

and their arrival during odd time of a day. To solve these issues, artificial rainfall was created to carry out the test. Using a bath room shower and a 0.5 HP pump, artificial rainfall was created on the roof. In artificial rainfall condition, 60 μ , 40 μ , 25 μ , 15 μ , 12 μ , and 7 μ were tested. In actual rainfall condition, 5 μ and 3 μ filters were tested. The roof water was allowed to pass through different sized mesh filters. Roof water samples were collected from the inlet and outlet end of the filter unit for quality analysis.

3.7 PERFORMANCE EVALUATION OF THE FIRST FLUSH SYSTEM

Mainly the first flush system for roof water harvesting is provided to collect and divert the highly contaminated water flowing down from the roof during the initial few minutes of starting of rainfall events. It is designed to check the mixing of first coming highly impure roof water with the next coming relatively cleaner roof water. Evaluation of the first flush system was carried out in two different modes: by not connecting with the filter and by connecting with the filter. As conducting the experiment under actual rainfall condition was very difficult as has been explained in the evaluation of mesh filters, simulated rainfall was created in this case also.

Performance of the first flush unit was performed by connecting the unit before the mesh filter of the roof water harvesting arrangement. After the first flush, all the eight different mesh filters were tested in series, one at a time with the first flush system is shown in the Fig.3.5. Samples for water quality testing were collected from the inlet of the first flush and from the outlet end of the mesh filter. The experiment was repeated for each mesh filter cum first flush combination. All the water quality parameters tested in the case of 'filter alone' case has also been done for filter cum first flush combination.

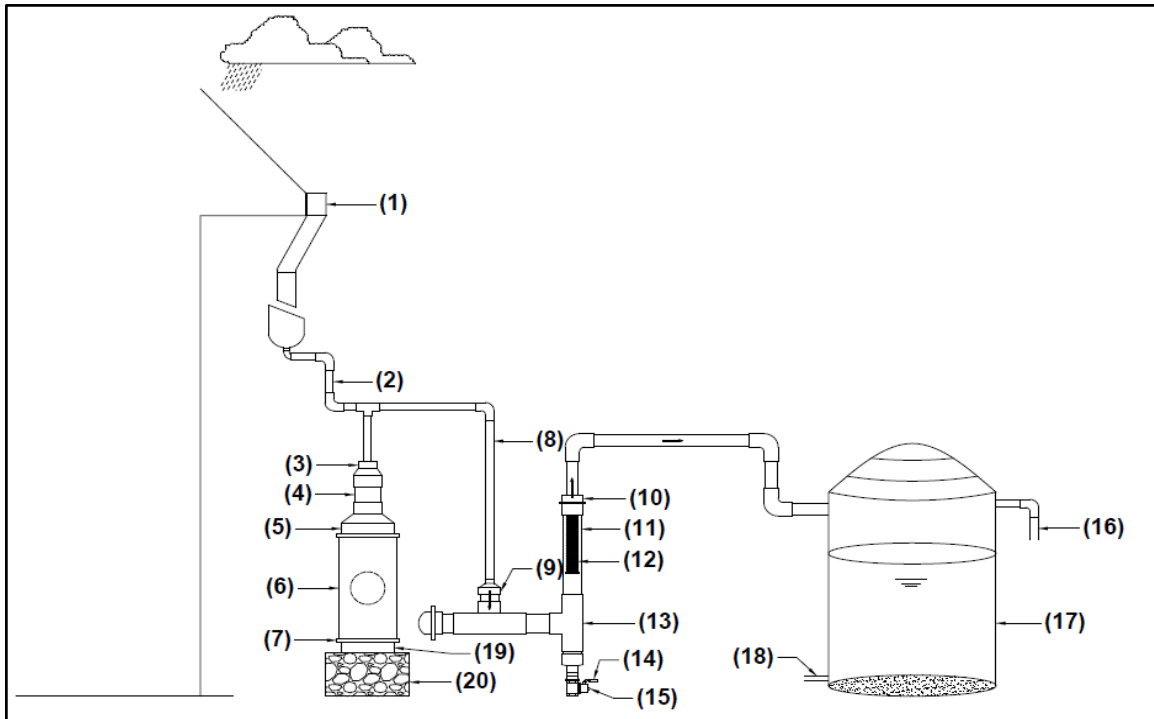

Fig. 3.5 Complete sectional view of the first flush and mesh filter system

1. Gutter 2. 63 mm ϕ PVC pipe 3. 110 \times 63 mm connector 4. 110 mm ϕ PVC pipe 5. 160 \times 110 mm connector 6. 160 mm ϕ PVC 7. 160 mm end cap 8. 63 mm ϕ PVC pipe 9. 90 \times 63 mm connector 10. 90 mm end Cap 11. 90 mm ϕ PVC pipe 12. Filter element 13. 90 mm t joint 14. 24 volts battery 15. 1.5 ϕ solenoid valve 16. Overflow pipe 17. Storage tank 18. Outflow pipe 19. Dripping hole 20. Supporting rock wall.

3.8 WORKING OF FIRST FLUSH AND FILTER UNDER ACTUAL RAINFALL

Rainwater coming down from the rooftop through the gutter and downpipe is conveyed to the first flushing unit having 20 l capacity. This first flush tank collect 20 l of initially generated most contaminated water. As the water level rises in the first flush chamber, the ball floats on the water surface and once the chamber is full, the ball presses upward against the inlet to the flush chamber and closes it, and thereby preventing any further entry of roof water into it. The subsequent flow of water is then automatically directed to the upward flow filter system along a 90 mm pipe where the incoming flow velocity is reduced and the debris is allowed to settle. Then, the rainwater with reduced velocity of flow move upward through the

annular space between the casing pipe and the filter element. Water then passes through the micro mesh of the filter where removal of suspended particles takes place. The filtered water then moves to the storage tank. The entire movement of water from the roof to the storage tank takes place under gravity force without the use of any additional energy.

Impure water collected in the first flush chamber will be drained slowly by dripping water through the dripper hole of 2 l/h discharge rate. It may take about 10 hours for emptying the chamber. Thus, the first flush chamber will be ready to receive and store the next lot of initial incoming roof water. The chamber can be cleaned by opening the end cap at the bottom. As the micro mesh filter unit is designed for the pass of water in upward direction, major portion of the suspended particles is settled at the bottom of the casing pipe and will reduce the load of impurities reaching the mesh filter. Impurities settled at the bottom can be removed by opening the end cap provided at the bottom and flushing.

3.9 AUTOMATIC FLUSHING SYSTEM

Automatic flush system consists of a solenoid valve of 50 mm ϕ (1.5 inch ϕ) which is connected to the bottom of the micro mesh filter. The solenoidal valve is made to open once a day for about 10 seconds in order to flush out the impurities collected at the bottom of the micro mesh filter. When the solenoidal valve opens, all the water collected in the casing pipe and the conveyance pipe fitted above the filter will be flowed down with high velocity. In this gush of water, all the impurities present in the filter unit will get flushed out and the filter will be clean and will be free of all the organic impurities.

Automatic operation of the solenoid valve is achieved through a light sensing- mechanism. When the valve is opened once, it remains open for 10 seconds so that there is enough opportunity for the impurities to get flushed out. Valve again will be opened after every first light incidence on the sense after a dark period. The valve is connected to a 24 volts electric supply the circuit diagram of the valve unit is given in fig 3.6.

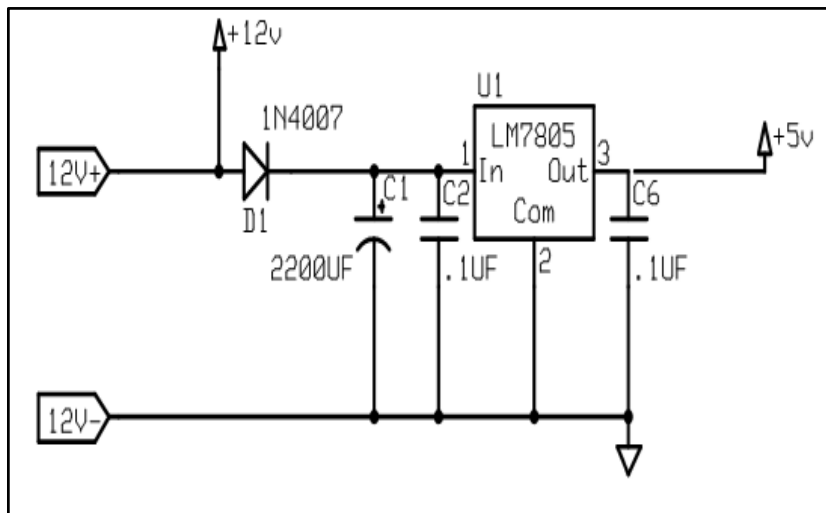
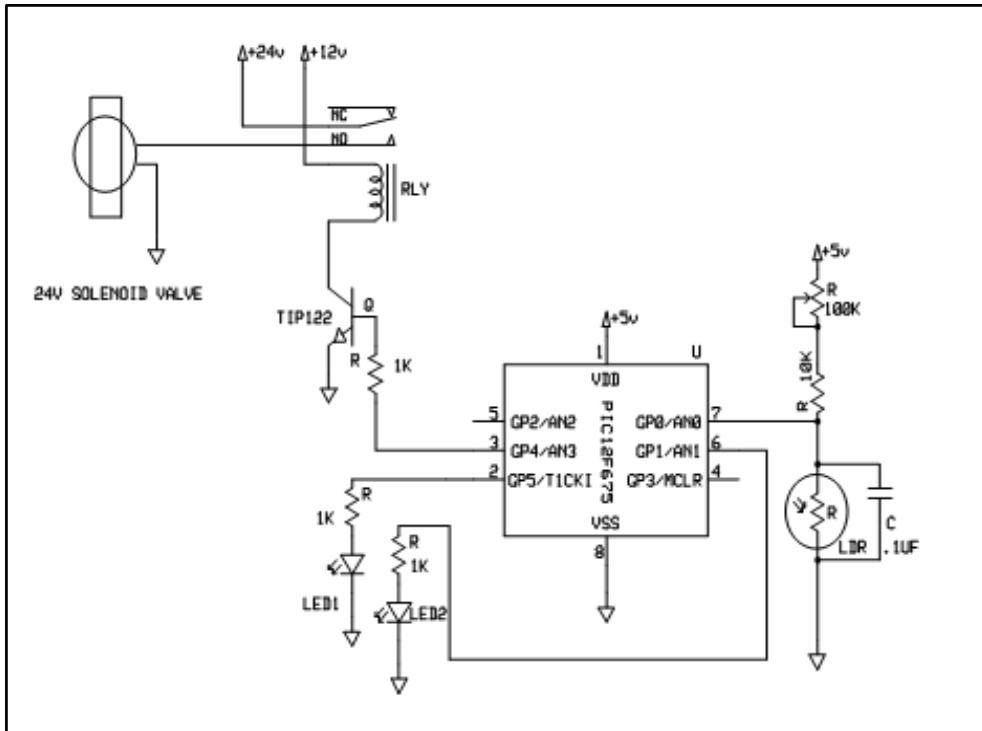

Fig. 3.6 Circuit diagram of automatic flush

3.10 ESTIMATION OF WATER QUALITY PARAMETERS

The analysis of various physical and chemical qualities of the inflow and outflow samples of the filter and that of the first flush system were carried out at soil and water laboratory of KCAET Tavanur. All the tests were carried out as per BIS standards. Details of different tests procedure are described below fig. 3.7.

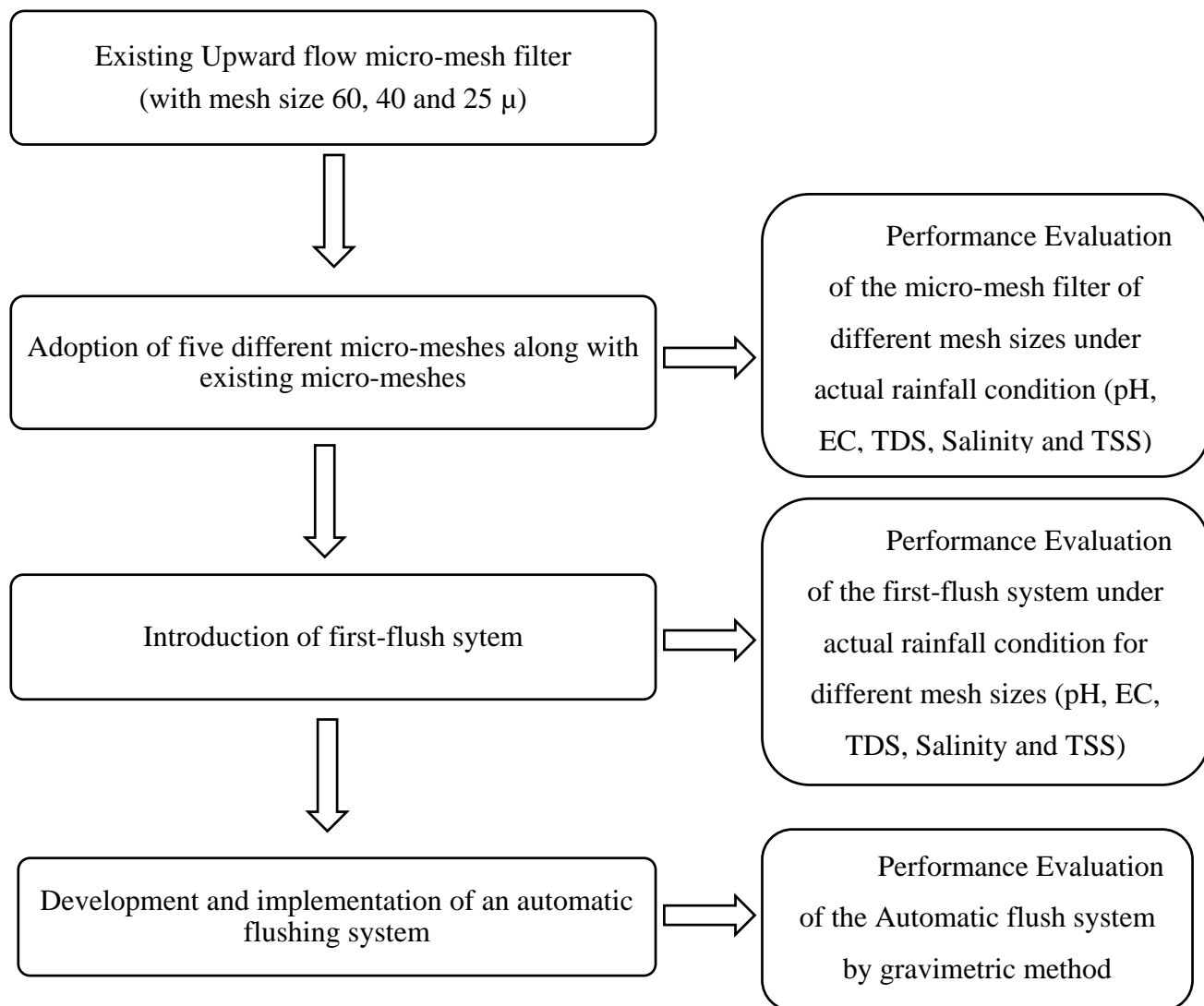

Fig. 3.7 Flow-chart showing performance evaluation of filter system and development of an automatic flush

3.10.1 Physical analysis using water quality analyser

A water quality analyzer, SYSTRONICS WATER QUALITY ANALYSER 371 was used to carry out the physical analysis of the collected rooftop rain water samples (Plate 3.1). It is a micro controller based instrument for measuring pH, salinity, electrical conductivity and TDS in water sample one at a time. The analyser provides both automatic and manual temperature compensation. Calibration or standardization of the instrument was done with standard solutions.

Provision for storing calibration of all appropriate modes is provided with the help of battery backup. This data can be further used for measuring the unknown, without recalibrating the instrument even after switching it off. A 20 x 2 alphanumeric LCD display along with 14 keys enables the user to select, set and operate the unit with ease. All the results will be displayed electronically on the display unit.

The important physical parameters which include pH, electrical conductivity, salinity and TDS of the rainwater and roof water samples collected for the study were tested with water quality analyser. Procedure adapted for testing each quality parameter of roof water samples collected for analysis is presented below.



Plate 3.1 Systronic water quality analyser

3.10.1.1 pH

The acidity or alkalinity of water is expressed as pH. The pH of an aqueous solution is a measure of the acid base equilibrium achieved by various dissolved compounds. The Bureau of Indian Standards (BIS) recommendation of pH for drinking water is 6.5 to 8.5. Water quality analyser determines the pH using pH

electrode (Plate 3.2). It consists of a glass bulb membrane, which gives its name and an electrically insulating tubular body, which separates an internal solution and a silver or silver chloride electrode from the solution under study. The Ag or AgCl electrode is connected to a lead cable terminal with some connector that can hook up to a special voltmeter of the pH meter. The pH meter measures the potential difference and its changes across the glass membrane. The potential difference must be obtained between two points; one is the electrode contacting with the internal solution and the second point is obtained by connecting to a reference electrode, immersed in the solution under study.



Plate 3.2 pH electrode

3.10.1.2 Electrical conductivity

Conductivity is the capacity of water to conduct electric current which varies both with the number and types of ions the solution contains. Conductivity in water is affected by the presence of inorganic dissolved solids such as chloride, nitrate, sulphate and phosphate anions (ions that carry a negative charge) or sodium, magnesium, calcium, iron, and aluminium cations (ions that carry a positive charge). Pure water is not a good conductor of electricity.

The electrical conductivity of the water also depends on the water temperature. While the electrical conductivity is a good indicator of the total salinity, it still does not provide any information about the ion composition in the water. Many EC meters nowadays automatically standardize the readings to 25⁰ C. The commonly used units for measuring electrical conductivity of water are $\mu\text{S}/\text{cm}$ (microSiemens/cm) or dS/m (deciSiemens/m). In the case of conductivity of the drinking water, the acceptable limit is up to 1500 $\mu\text{S}/\text{cm}$, according to BIS standards (Plate 3.3).



Plate 3.3 Conductivity cell

3.10.1.3 Salinity

Salinity means the amount of dissolved salts present in the water. Salt compounds like magnesium sulphate, sodium chloride, sodium bicarbonate and potassium nitrate. It is commonly measured in parts per thousand (ppt). Salinity affects animals living in water, aquatic plants and affects water quality as a whole. The rainwater samples normally will have low salinity value. However, harvested rooftop water can have different level of salinity due to the interaction of rainwater with the roof surface.

3.10.1.4 TDS

The total dissolved solids concentration is the sum of the cations (positively charged) and anions (negatively charged) ions in the water. Therefore, the total dissolved solids test is a qualitative measure of the amount of dissolved ions. TDS test does not tell the nature or ion relationships. Since the relationship is not constant, total dissolved solids concentration can be related to the conductivity of the water. The relationship between total dissolved solids and conductivity is a function of the type and nature of the dissolved cations and anions in water. TDS is not a direct measure of a specific element or contaminant. An elevated TDS may be associated with an elevated water hardness, chemical deposits, corrosion by-products, staining, or salty bitter tastes. If the TDS content of the water is more, the primary recommendation would be to test the water for additional parameters, such as total hardness, iron, manganese, sodium, chloride, sulphate, alkalinity and nitrate, to determine the nature of the water quality problem. The TDS test is an ideal indicator of the potential for water quality problems. The presence of high levels of TDS would be disagreed by consumers, owing to excessive scaling in water pipes, heaters, boilers and household appliances. No health based guideline value for TDS has been proposed. According to WHO water quality guidelines acceptable threshold of TDS is from 1000 to 1200 mg/l. Secondary Maximum Contaminant Level (SMCL) for total dissolved solids (TDS) is 500 mg/l. For harvested rainwater, TDS is affected by the catchment area and storage facility type and conditions. All the three parameters viz. pH, electrical conductivity, and TDS indirectly refer to the salt content of the water.

3.10.2 Total suspended solids by gravimetric method

Total suspended solids (TSS) are defined as the portion of total solids in a water sample retained by a glass fiber filter of pore size greater than 2 μ . Total suspended solids (TSS) are particles that are larger than 2 microns, found in the water column and anything smaller than 2 microns (average filter size) is considered as dissolved solid. Most of the suspended solids are made from inorganic materials, though bacteria and algae can also contribute to the total solids concentration. These solids include anything

drifting or floating in the water, from sediment, silt, and sand to plankton and algae. Organic particles from decomposing materials can also contribute to the TSS concentration. As algae, plants and animals decay, the decomposition process allows small organic particles to break away and enter the water column as suspended solids. Even chemical precipitates are considered as a form of suspended solids. Total suspended solids are a significant factor in observing water clarity.

The most important impurities in the roof water in Kerala condition are suspended matters and it includes mainly organic moss and inorganic sand and fine dust particles. Hence, the quantity of suspended particles are determined through gravimetric measurements. For measuring suspended solids, the water is filtered through a fine filter (Whatmann, Grade 1, 110 mm ϕ) and the dried and cooled material retained on the filter is weighed. The drying was carried out for one hour in an oven at 105° C. The filter paper was dried prior to the filtration for 30 minutes in order to make the water content of the filter paper equal to that after drying with filtered out impurities. Hence, the filter paper with impurities dried in the oven is kept in the room temperature for about 30 minutes for cooling and then only its weight is determined

$$\text{Total suspended solids in g/l} = \frac{W_2 - W_1}{V} \times 1000 \quad \dots 3.1$$

Where,

W_1 = Initial weight of filter paper, g

W_2 = Weight of filter paper and the dry material retained on the filter, g

V = Volume of water sample, ml



Plate 3.4 Gravimetric experimental setup for total suspended solids

3.11 ESTIMATION OF FILTER EFFICIENCY OF SUSPENDED SOLIDS

Filter efficiency refers to the amount of removal of impurities by the filter system. Hence, the filtration efficiency has been worked out based on the removal of the suspended impurities. For this, the concentrations of suspended solids in the water before filtering and after filtering are found out as per the procedure mentioned in 3.9.2. Then, efficiency of the filters has been determined by the following equation.

$$E = \frac{S_b - S_a}{S_b} \times 100 \quad \dots 3.2$$

Where,

E = Efficiency of the filter, %

S_b = Suspended solids before filtering, mg/l.

S_a = Suspended solids after filtering, mg/l.

3.12 DISCHARGE RATE OF DIFFERENT FILTER SYSTEMS

3.12.1 Volumetric measurement

Discharge rate of the micro mesh filters are very important as the filter system demands high flow rate during different rainfall events, especially during high rainfall intensities. If the filter discharge rate is less, there will be overflow of rooftop collected water from gutters which give rise to loss of water in one account and undesirable situation of falling water from the higher levels to the ground. Hence, discharge rates of every micro mesh filter was evaluated. For the discharge measurements, outflow from the filters were collected for a known time and the volume of collected water is measured to get the discharge. The discharge of the various filters has been determined by the following equation.

$$D = \frac{V}{T} \quad \dots 3.3$$

Where,

D = Discharge, (l/s)

V= Volume, (l)

T= Time, (s)

CHAPTER 4

RESULTS AND DISCUSSIONS

The performance evaluation of different micromesh filters, first flush system and the automatic flush developed for the study is presented here. Micromesh filters of various mesh sizes were evaluated with regard to the purification of roof water. Performance of first flush system was tested in isolation and also in combination of first flush system with micromesh filters to evaluate its impact on the purification of rooftop rain water. The impact of automatic flush on the removal of filtered out impurities from the filter system was also evaluated. Various water quality parameters tested are pH, EC, SAL, TDS and TSS.

4.1 PERFORMANCE EVALUATION OF DIFFERENT MICROMESH FILTERS

4.1.1 pH

Table 4.1 pH of water samples of the inflow and outflow of mesh filters

Mesh size	Inflow/Outflow	pH
60 Micron filter	Inflow	7.7
		7.5
	Outflow	7.31
		7.59
		7.62
	40 Micron filter	Inflow
6.85		
Outflow		6.39
		6.76
		7.14

Table 4.1 Continued

25 Micron filter	Inflow	7.29
		7.36
	Outflow	6.84
		7.54
		7.39
	15 Micron filter	Inflow
7.32		
Outflow		7.41
		7.68
		6.88
12 Micron filter		Inflow
	6.93	
	Outflow	6.7
		6.74
		6.9
	7 Micron filter	Inflow
7.29		
Outflow		7.26
		7.36
		7.04

Table 4.1 Continued

5 Micron filter	Inflow	6.1
		5.9
	Outflow	5.8
		5.75
		6
3 Micron filter	Inflow	5.9
		6.3
	Outflow	6.5
		5.8
		6

The pH of the roof water samples collected from the inflow and outflow of different size micromesh systems are shown in Table 4.1. and Fig. 4.1. There was no considerable difference between the pH values of inflow and outflow in the case of all the eight filters of different micro mesh sizes used in this study. However, the filtered water seemed more close to 7(neutral) in several cases. The reason for this could be that the impurities present in roof water may be varying its acid base equilibrium.

It can be seen that rooftop rainwater and thereby the rainwater in this region is near to 7 (neutral) and is very well within suitable limit of recommendations given by BIS (6.5-8.5) and WHO (6.5-8.0) for drinking purpose. The results obtained are similar with the studies reported by Thomas and Greene, 1993.

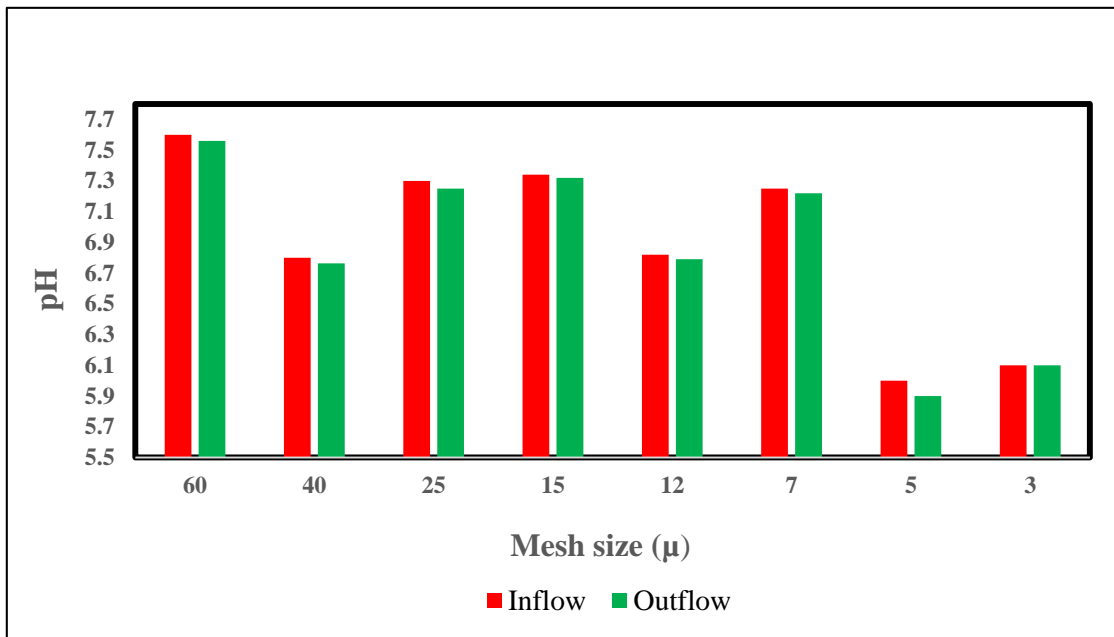

Fig. 4.1 pH of roof water samples

4.1.2 Electrical conductivity (EC)

Electrical conductivity of the inflow and outflow of roof water samples from the micro mesh filters were analysed in the KCAET Tavanur laboratory using the water quality analyser and the results obtained are presented in Table 4.2 and Fig 4.2. It can be seen that there was considerable decrease in electrical conductivity (7 to 15 percentage) after micromesh filtration in the case of all the eight filters. The reduction in electrical conductivity increases as mesh size decreases from 60 micron to 3 micron. Electrical conductivity is influenced by dissolved impurities, the decrease in electrical conductivity indicates that the removal of suspended impurities may be causing its reduction, as the oxidation and dissolution of some of the suspended impurities may be increasing the electrical conductivity. Electrical conductivity variation in inflow roof water ranges between 114 to 160 $\mu\text{s}/\text{cm}$ and in outflow the variation is from 100 to 148 $\mu\text{s}/\text{cm}$. Ions getting introduced into the roof water may be the reason for higher EC in inflow water. Reduction in EC in the case of 3 micron mesh was about 33 %. In the case of 5 micron mesh, the corresponding figure was 52 %. Roof water purification experiment was done under actual rainfall condition in the case of 5 and 3 micron filter.

Table 4.2 EC of roof water samples of the inflow and outflow of mesh filters

Mesh size	Inflow/Outflow	EC ($\mu\text{s/cm}$)
60 micron filter	Inflow	135
		136
	Outflow	131
		134
		129
40 micron filter	Inflow	116
		114
	Outflow	100
		112
		114
25 micron filter	Inflow	126
		129
	Outflow	122
		126
		125
15 micron filter	Inflow	148
		148
	Outflow	132
		126
		126
12 micron filter	Inflow	119
		110
	Outflow	113
		115
		114

Table 4.2 continued

7 micron filter	Inflow	156
		160
	Outflow	141
		150
		148
5 micron filter	Inflow	92
		80
	Outflow	41.9
		40.9
		39.7
3 micron filter	Inflow	125
		121
	Outflow	81.7
		81.5
		83.1

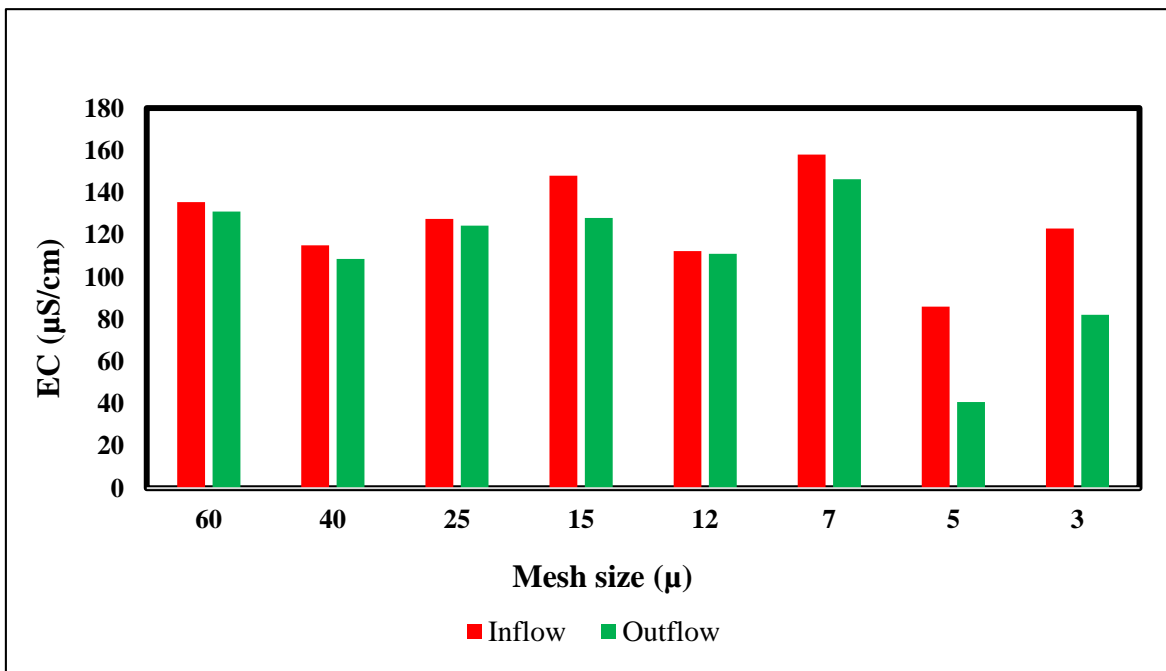

Fig. 4.2 EC of roof water samples

4.1.3 Total dissolved solids (TDS)

Dissolved solids present in the inflow and outflow of the roof water samples of the different micro mesh size filter system are exhibited in Table 4.3 and Fig 4.3. TDS values were ranging from 48 to 101 ppm. There is about 7 to 15 percentage reduction in the EC values after filtration. At the same time, variations in the reduction of TDS between different mesh sizes were not well distinguishable. The reason for the reduction in TDS may be due to the reduction in suspended and other solid impurities as explained in the case of electrical conductivity. Even in the case of inflow water, the level of TDS was very low when compared to the allowable limits as given by WHO (1000 ppm). According to IS 10500-1991, desirable limit of TDS is 500ppm.

Table 4.3 TDS of roof water samples of the inflow and outflow of mesh filters

Mesh size	Inflow/Outflow	TDS(ppm)
60 micron filter	Inflow	86.7
		85.6
	Outflow	87.9
		85.5
		82.5
	40 micron filter	Inflow
87.5		
Outflow		84.1
		85.9
		84.1

Table 4.3 Continued

25 micron filter	inflow	88
		87.3
	outflow	86.2
		81.6
		81.8
15 micron filter	inflow	95.8
		87.4
	outflow	90
		89.4
		79.9
12 micron filter	inflow	74.9
		70.6
	outflow	72.1
		74.3
		72.9
7 micron filter	inflow	107.9
		105.1
	outflow	108
		103
		104

Table 4.3 Continued

5 micron filter	Inflow	52.3
		40.5
	Outflow	44.3
		46.4
		42
3 micron filter	Inflow	41.6
		45.2
	Outflow	41.9
		40.4
		39

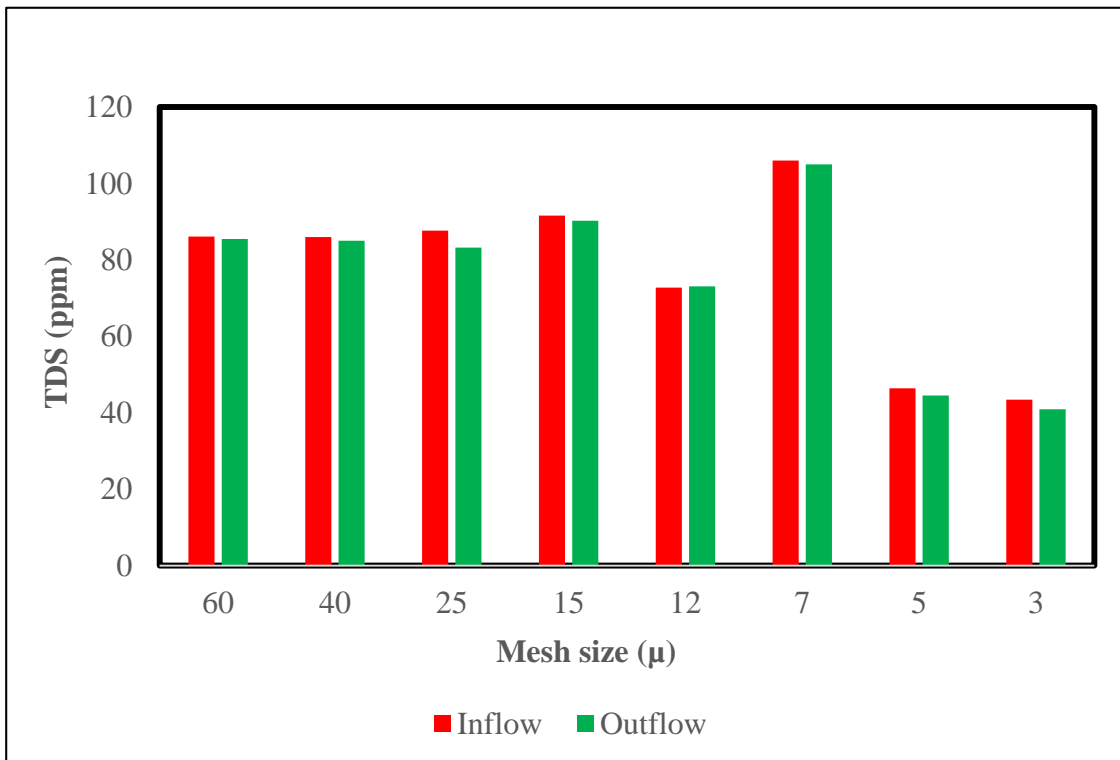

Fig. 4.3 TDS of roof water samples

4.1.4 Salinity (SAL)

Salinity present in the inflow and outflow of the roof water samples of the different micro mesh size filter system are shown in Table 4.4 and Fig 4.4. Salinity means the amount of dissolved salts present in the water. It is commonly measured in parts per thousand (ppt). Salinity affects the living places of animals, aquatic plants and also affects water quality. The rainwater samples have normally low salinity value, the reduction in salinity is distinguishable in the case of 5 and 3 micron mesh filters. About 60 to 70 % reduction in salinity is observed in these two filter systems.

Table 4.4 Salinity of roof water samples of the inflow and outflow of mesh filter

Mesh size	Inflow/Outflow	SAL(ppt)
60 Micron filter	Inflow	0.09
		0.09
	Outflow	0.08
		0.09
		0.083
	40 Micron filter	Inflow
0.09		
Outflow		0.09
		0.08
		0.1
25 Micron filter		Inflow
	0.09	
	Outflow	0.09
		0.085
		0.08

Table 4.4 Continued

15 Micron filter	Inflow	0.1
		0.1
	Outflow	0.09
		0.1
		0.98
12 Micron filter	Inflow	0.08
		0.07
	Outflow	0.07
		0.07
		0.07
7 Micron filter	Inflow	0.08
		0.07
	Outflow	0.07
		0.07
		0.07
5 Micron filter	Inflow	0.08
		0.05
	Outflow	0.03
		0.02
		0.02
3 Micron filter	Inflow	0.03
		0.03
	Outflow	0.01
		0.01
		0.01

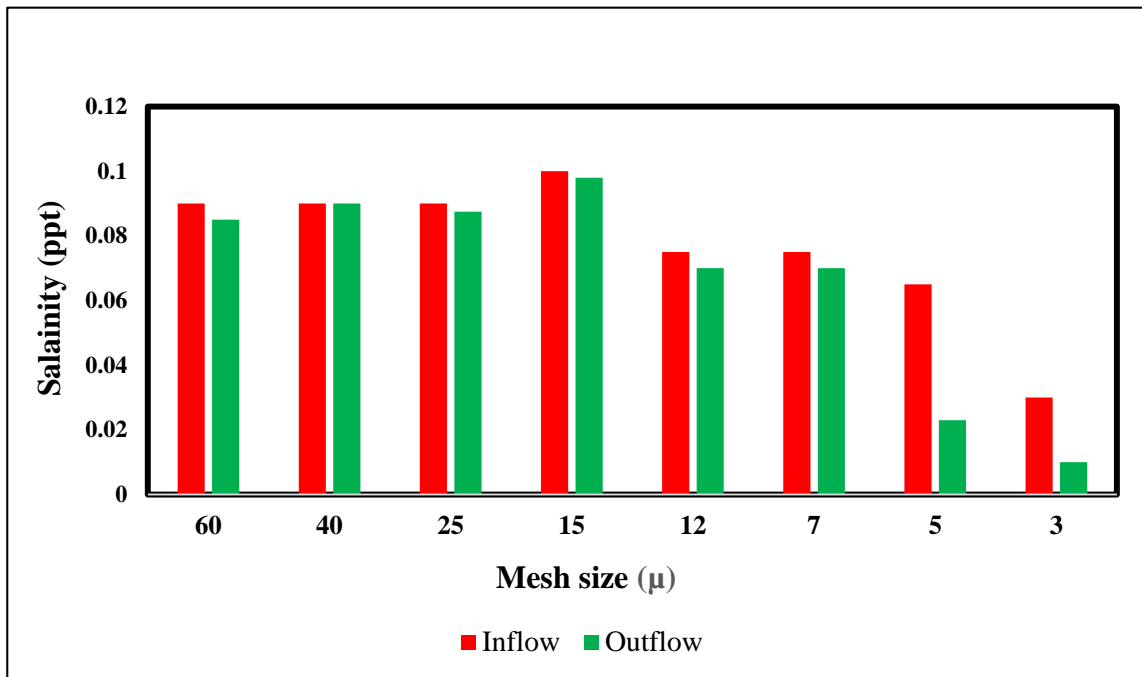

Fig. 4.4 Salinity of roof water samples

4.1.5 Total suspended solids (TSS)

The results of the analysis of suspended matter impurities in the inflow and outflow of the filter system are shown in the Table 4.5 and Fig 4.5. In the case of inorganic suspended matter, the allowable limit as per WHO and BIS is 500 mg/l. On the other hand, the allowable level of organic impurities is less than 1 mg/l. The level of suspended matter impurities present in roof water, which is mainly organic in nature, was observed to be of the order of 400 to 1000 mg/l. This value is very high from the drinking water quality standards. Hence, the main challenge of roof water harvesting is the removal of organic suspended matter impurities.

While comparing the impurity level in the inflow and outflow, it can be seen that about 90 percentage of suspended impurities were removed by the mesh filter developed of sizes 60, 40 and 25 micron. TSS values of the filtered water was about 60 mg/l against an average inflow concentration of 280 mg/l. TSS concentration of outflow for 15 and 12 micron filters, were near to 40 mg/l. and in the case of 7 and 5 micron filters, the concentration were near to 20 mg/l. It is to be highlighted that in the case of 3 micron filter the TSS impurities were nill in the filtered water. This result should be viewed along with the fact that the lower limit of the suspended

particle is 2 micron. The result indicate that there is no need of further decreasing the mesh size from point of view removal of suspended impurities.

Table 4.5 TSS of roof water samples of the inflow and outflow of mesh filter

Mesh size		Weight of filter paper (mg)	Weight of filter paper with filtration after drying (mg)	Concentration of suspended solids (mg/l)
60 Micron filter	Inflow	860	920	240
		860	930	280
	Outflow	860	880	80
		860	870	40
		860	875	60
40 Micron filter	Inflow	860	925	260
		860	920	240
	Outflow	860	870	40
		860	875	60
		860	870	40
25 Micron filter	Inflow	860	930	280
		860	915	220
	Outflow	860	870	40
		860	875	60
		860	865	20
12 Micron filter	Inflow	860	915	220
		860	920	240
	Outflow	860	865	20
		860	870	40
		860	870	40

Table 4.5 Continued

7 Micron filter	Inflow	860	930	280
		860	925	260
	Outflow	860	875	60
		860	870	40
		860	865	20
5 Micron filter	Inflow	860	925	260
		860	915	220
	Outflow	860	862	8
		860	863	12
		860	862	8
3 Micron filter	Inflow	860	925	260
		860	920	240
	Outflow	860	860	0
		860	860	0
		860	860	0

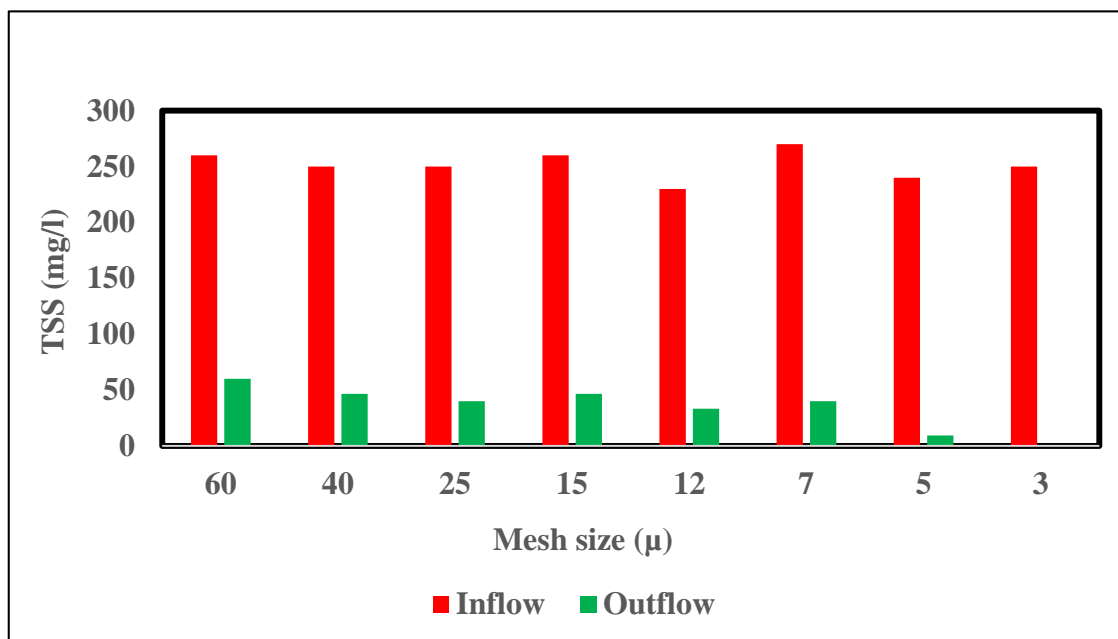

Fig. 4.5 TSS of roof water samples

4.2 PERFORMANCE EVALUATION OF FIRST FLUSH WITH FILTER UNDER ACTUAL RAINFALL CONDITION

Performance evaluation of the first flush systems has also been done under actual rainfall condition. It is connected at the inlet side of the upward flow filter system. The total experimental system adopted for the evaluation of the filter system was also done in the case of first flush system. Rooftop rain water samples were analysed for the water quality parameters of pH, EC, SAL, TDS and TSS by repeating the experiment by connecting the first flush in series with the filter system, with the first flush in the inlet end of the micromesh filter.

4.2.1 pH

The pH of the roof water samples collected from the inlet and outlet end of the first flush cum filter system are given in Table 4.6 and Fig 4.6. No markable changes were seen in the pH the roof water inflow and outflow samples when compared to that of the “only mesh filter” case.

Table 4.6 pH of roof water samples of the inflow and outflow of first flush with mesh filter

Mesh size	Inflow/Outflow	pH
60 Micron filter	Inflow	7.84
		7.43
	Outflow	7.44
		7.69
		7.59
40 Micron filter	Inflow	7.68
		7.64
	Outflow	7.62
		7.68
		7.52

Table 4.6 Continued

25 Micron filter	Inflow	7.99
		8.01
	Outflow	7.88
		7.98
		7.95
	15 Micron filter	Inflow
7.75		
Outflow		7.96
		7.62
		7.69
12 Micron filter		Inflow
	7.81	
	Outflow	7.76
		7.5
		7.64
	7 Micron filter	Inflow
7.64		
Outflow		7.64
		7.58
		7.58

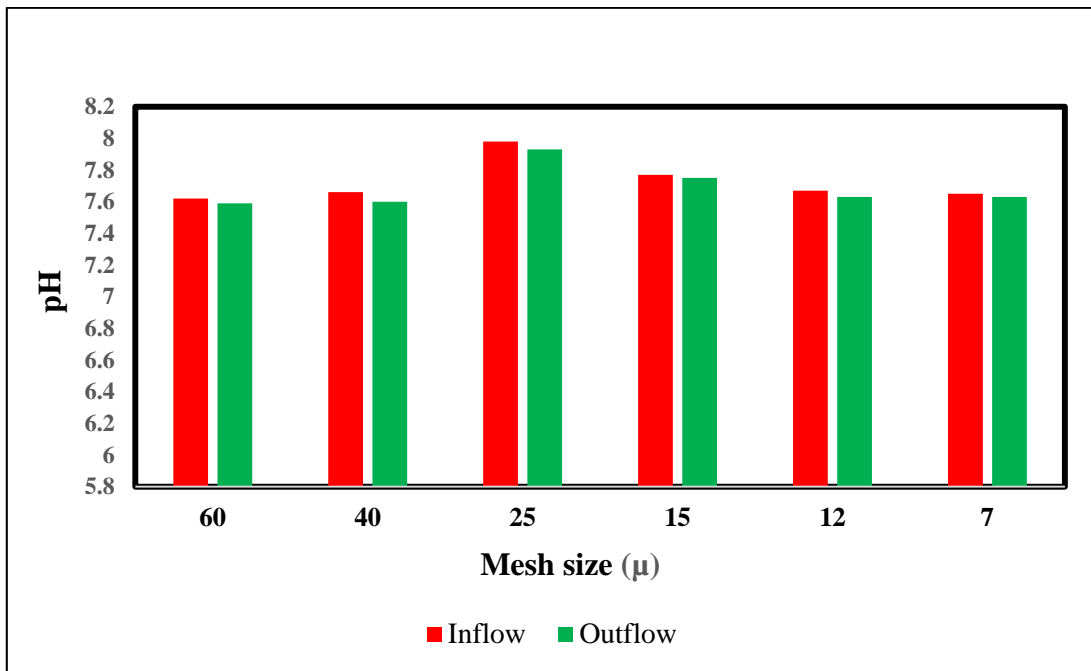

Fig 4.6 pH of roof water samples for first flush with filter system

4.2.2 Electrical conductivity

The electrical conductivity (EC) values of the inflow and outflow roof water samples with the first flush cum filter system are presented in Table 4.7 and Fig 4.7. The results were not appreciably different from that of filter alone case. Hence, it is to be inferred that the addition of first flush is not making any markable positive impact on the water quality parameter, EC of roof water.

Table 4.7 EC of roof water samples of the inflow and outflow of first flush with mesh filter

Mesh size	Inflow/Outflow	EC(μs/cm)
60 micron filter	Inflow	130
		126
	Outflow	112
		113
		119

Table 4.7 Continued

40 Micron filter	Inflow	128
		130
	Outflow	117
		120
		120
25 Micron filter	Inflow	187
		198
	Outflow	123
		125
		120
12 Micron filter	Inflow	125
		121
	Outflow	106
		111
		107
7 Micron filter	Inflow	139
		134
	Outflow	126
		125
		121

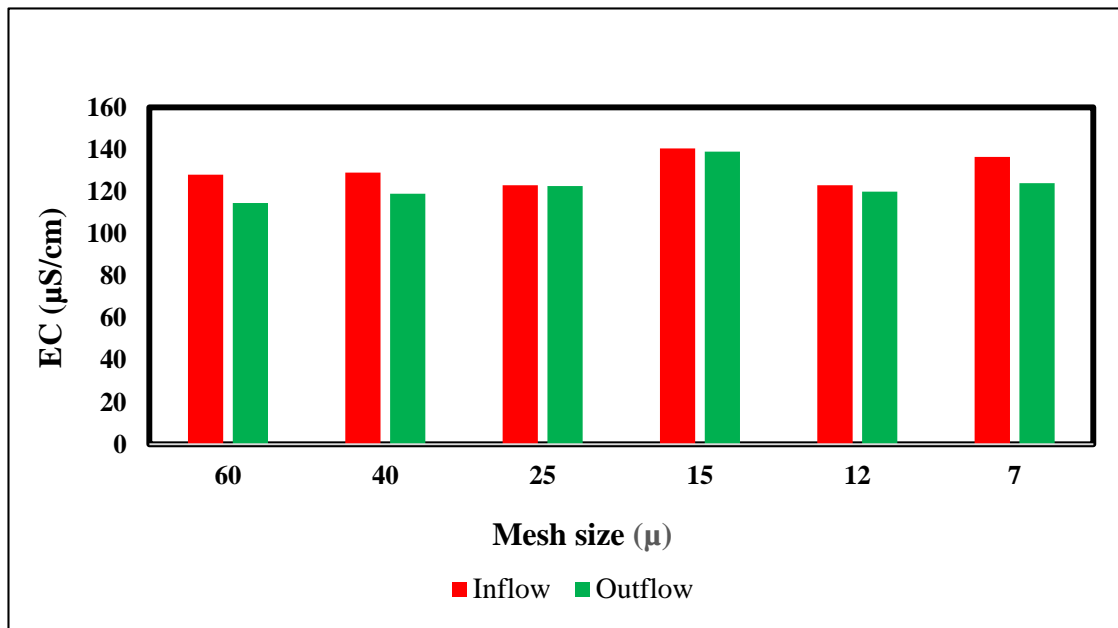

Fig 4.7 EC of roof water samples for first flush with filter system

4.2.3 Total dissolved solids

The TDS values of inflow and outflow roof water samples are tabulated and presented in Table 4.8 and Fig 4.8. In this case also, the results were not appreciably different from that of “filter only” case.

Table 4.8 TDS of roof water samples of the inflow and outflow of first flush with mesh filter

Mesh size	Inflow/Outflow	TDS (ppm)
60 Micron filter	Inflow	86.2
		83
	Outflow	84
		83
		82.5
40 Micron filter	Inflow	77.7
		76.9
	Outflow	76.7
		75.3
		76.4

Table 4.8 Continued

25 Micron filter	Inflow	118
		122
	Outflow	114.5
		116
		114
	15 Micron filter	Inflow
79.9		
Outflow		81.4
		82.2
		82.3
12 Micron filter		Inflow
	66.6	
	Outflow	67.6
		68.2
		67
	7 Micron filter	Inflow
87.2		
Outflow		85.8
		85.9
		86.4

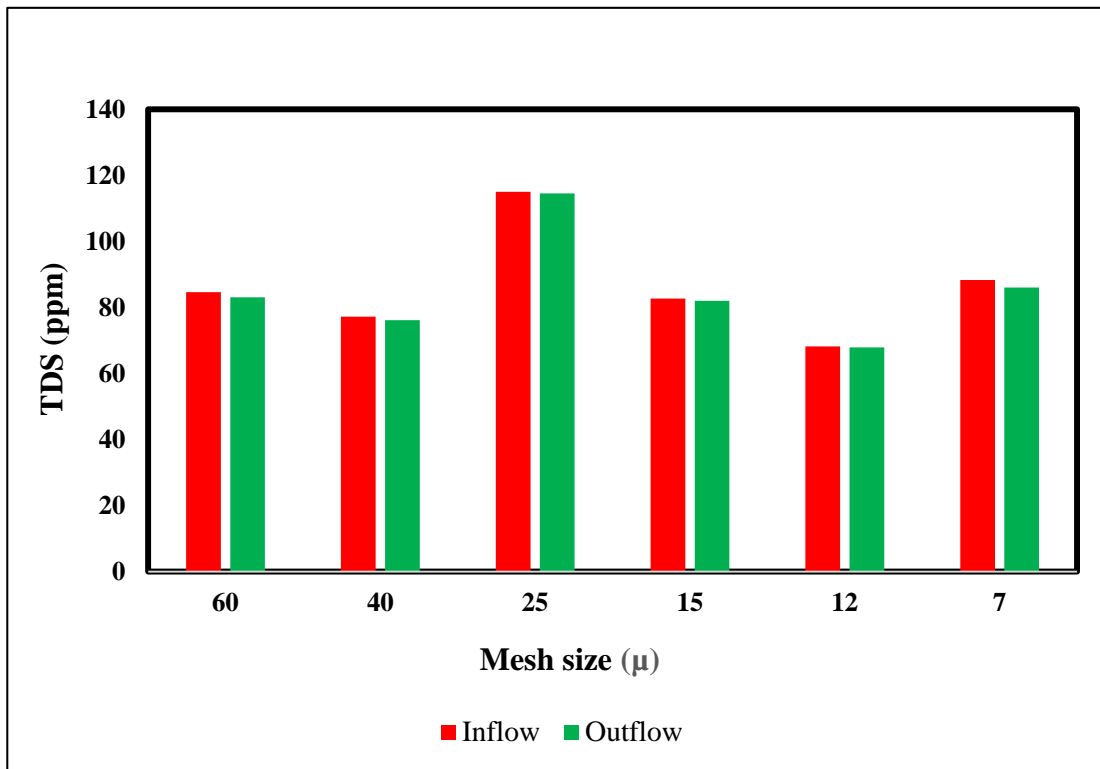

Fig 4.8 TDS of roof water samples for first flush with filter system

4.2.4 Salinity

The salinity values of the inflow and outflow roof water samples are tabulated and presented in Table 4.9 and Fig 4.9. The results were not considerably different from that of filter alone case. Hence, it is to be inferred that the addition of first flush is not making any markable reduction of the water quality parameter, salinity of roof water.

Table 4.9 Salinity of roof water samples inflow and outflow of first flush with mesh filter

Mesh size	Inflow/Outflow	SAL(ppt)
60 Micron filter	Inflow	0.1
		0.08
	Outflow	0.088
		0.089
		0.087
40 Micron filter	Inflow	0.08
		0.08
	Outflow	0.08
		0.07
		0.08
25 Micron filter	Inflow	0.1
		0.08
	Outflow	0.085
		0.088
		0.086
15 Micron filter	Inflow	0.08
		0.08
	Outflow	0.08
		0.08
		0.08

Table 4.9 Continued

12 Micron filter	Inflow	0.07.3
		0.072
	Outflow	0.07
		0.08
		0.07
7 Micron filter	Inflow	0.09
		0.09
	Outflow	0.09
		0.08
		0.09

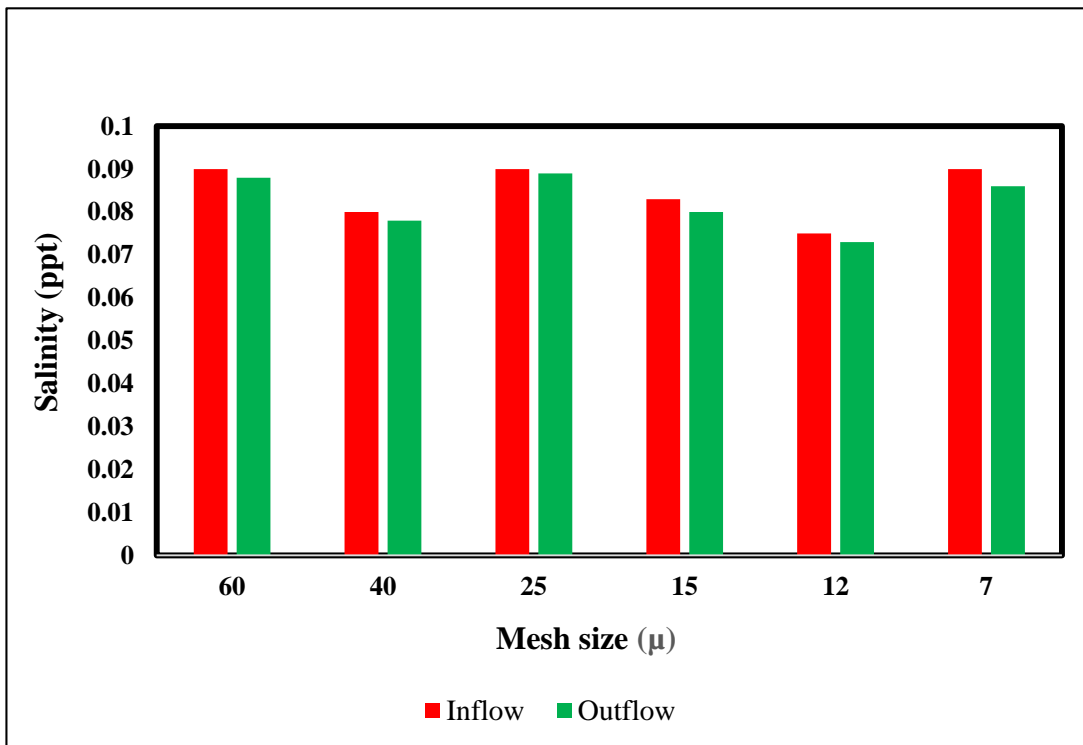

Fig 4.9 Salinity of roof water samples for first flush with filter system

4.2.5 Total suspended solids

The results of the analysis of the TSS of the inflow and outflow samples of the first flush and filter combination is given in Table 4.10 and Fig. 4.10. There is considerable reduction in the TSS of outflow samples compared to the “only filter” case. The reduction is about 30 percentage in the case of coarser micron mesh filters viz. 60, 40 and 25 micron. This reduction of TSS can be attributed to the positive contribution of the first flush system.

Table 4.10 TSS of roof water samples of inflow and outflow of first flush with mesh filter

Mesh size		Weight of filter paper (mg)	Weight of filter paper with filtration after drying (mg)	Concentration of suspended solids (mg/l)
60 Micron filter	Inflow	860	890	120
		860	880	80
	Outflow	860	870	40
		860	875	20
		860	875	60
40 Micron filter	Inflow	860	900	160
		860	890	120
	Outflow	860	870	40
		860	875	60
		860	870	40
25 Micron filter	Inflow	860	910	200
		860	920	240
	Outflow	860	880	80
		860	870	40
		860	875	60

Table 4.10 Continued

15 Micron filter	Inflow	860	890	120
		860	900	160
	Outflow	860	875	60
		860	870	40
		860	880	80
	12 Micron filter	Inflow	860	890
860			885	100
Outflow		860	880	80
		860	875	60
		860	870	40
7 Micron filter		Inflow	860	900
	860		890	120
	Outflow	860	870	40
		860	865	20
		860	870	40

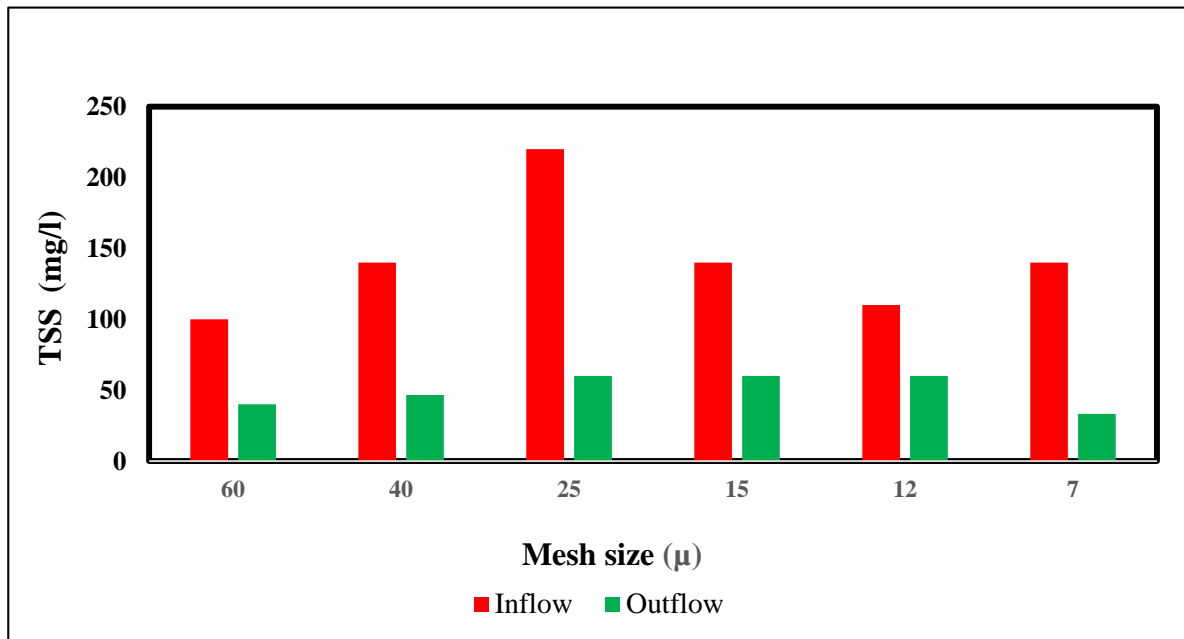

Fig 4.10 TSS of roof water samples for first flush with filter system

4.3 PERFORMANCE EVALUATION OF THE AUTOMATIC FLUSH

Operation and the performance of the automatic flush to remove the filtered out impurities from the mesh filter unit was tested thoroughly. The light based opening of the solenoid valve was taking place once in a day. Duration of the opening of the valve was for 10 seconds. It was found that opening of the solenoid valve for 10 seconds duration was sufficient to remove all the water stagnant in the upward flow filter mechanism. The removal efficiency of the rooftop impurities in the stagnant water was evaluated by quantifying the impurities load before and after the flush out. About 100 ml of rooftop water was allowed to pass through the filter unit. The impurity load in the stagnant water in the filter system was measured by gravimetric method before and after the automatic flush out. It was found that, the impurities load was 37.98 g before the automatic flush out and after flushing out the remaining impurities load in the system was 3.20g. The result is presented in fig 4.11. Percentage removed of impurities was 92 %. Further, the automatic flushing unit was draining the filter unit completely avoiding all possibilities of any anaerobic decomposition. It can be concluded that the automatic flushing unit was a success in improving the performance of the upward flow filter system.

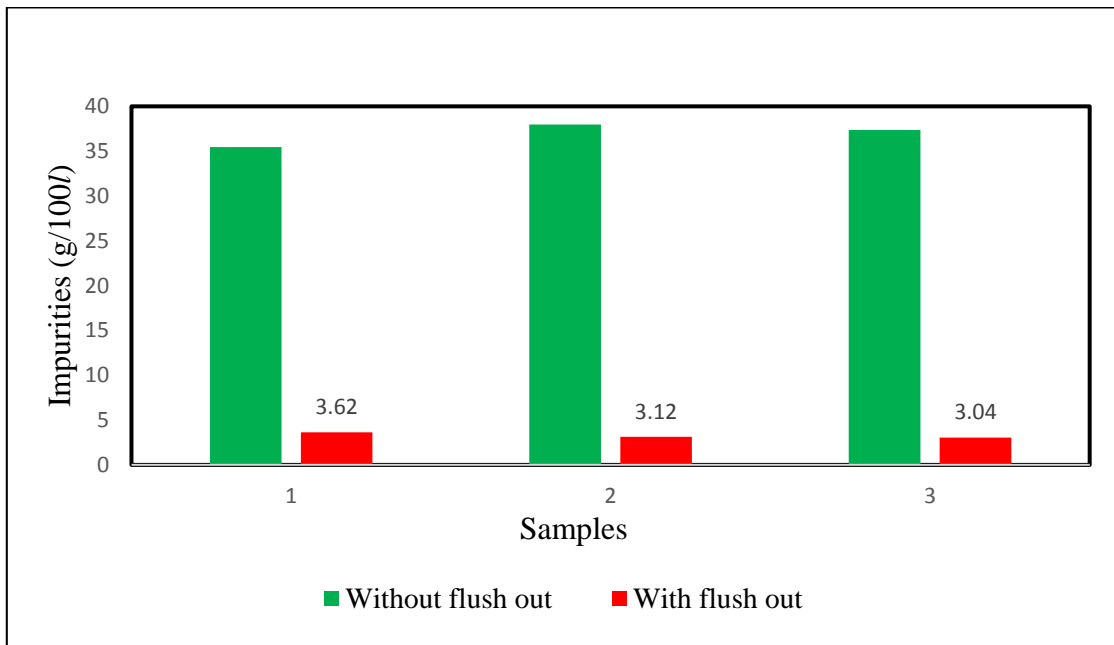

Fig. 4.11 Concentration of impurities (g/100l) with flush and without automatic flush

4.4 FILTRATION EFFICIENCY OF SUSPENDED SOLIDS

The main function of the mesh filters are the removal of suspended matter. Along with the removal of suspended impurities it also helps in reducing the presence of other undesirable material and improves the overall quality of potability of roof water. Hence, the filtration efficiency of the mesh filters was evaluated from the point of removal of suspended impurities. It is presented in Table 4.11 and Fig 4.12 and it shows very high values in the case of all the eight filters. As expected, when the mesh size decreases, the efficiency increases and the highest efficiency of 100 % is obtained for 3 micron mesh filter.

Table 4.11 Filtration efficiency of different micro mesh filters

Mesh size	Suspended solids before filtering (mg/l)	Suspended solids after filtering(mg/l)	Efficiency (%)	Mean average efficiency (%)
60 Micron filter	240	80	66.6	72.55
	280	60	78.5	
40 Micron filter	260	40	84.6	79.8
	240	60	75	
25 Micron filter	280	60	78.5	80.15
	220	40	81.8	
15 Micron filter	280	60	84.6	83.95
	240	40	83.3	
12 Micron filter	220	20	90.9	87.1
	240	40	83.3	
7 Micron filter	280	20	92.8	88.7
	260	40	84.6	
5 Micron filter	260	8	96.9	96.6
	220	8	96.3	
3 Micron filter	260	0	100	100
	240	0	100	

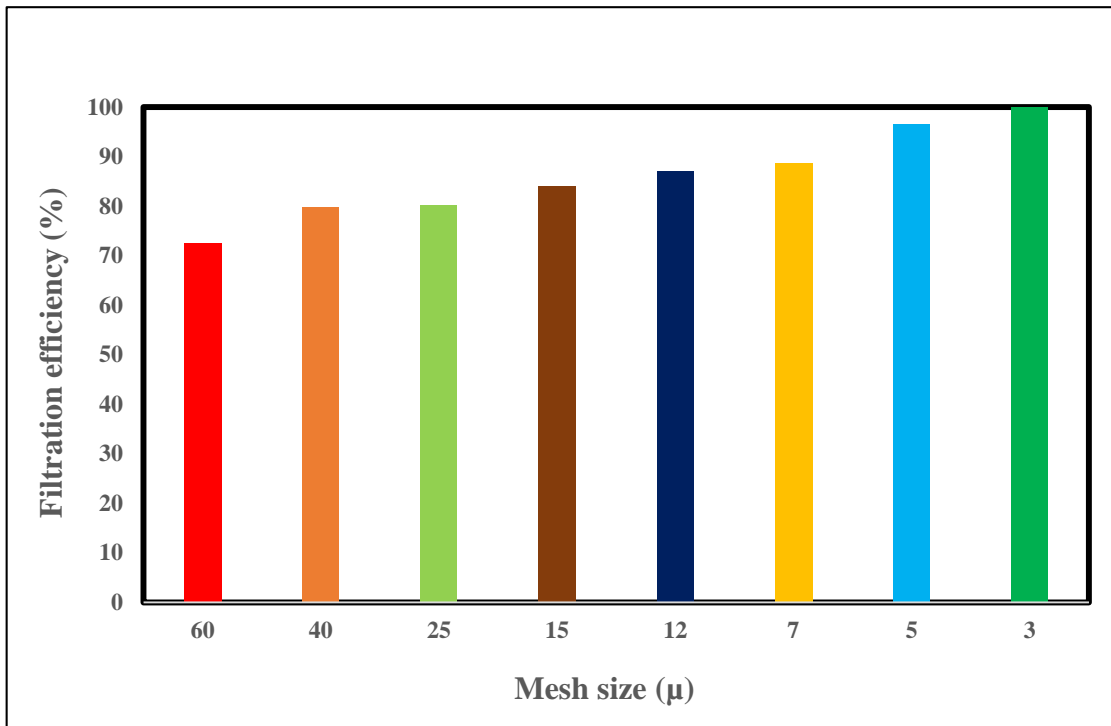

Fig. 4.12 Filtration efficiency of different micro mesh filters

4.5 DISCHARGE RATE OF DIFFERENT FILTER SYSTEMS

Discharge rate of the different filters are important in the case of roof water harvesting. As rain last for shorter intervals, the incoming roof water to the filter system also will be for short duration but with high discharge. Here, volumetric measurement was adopted in determining the filtration rate. This information will be of great use to others in designing mesh filters to suit to their requirement.

The discharge rates of different filters at a hydraulic head of 1.5m are presented in Table 4.12. Even 3 micron filter has a discharge of 0.37 l/s under a head of flow of 1.5m. Filtration rate per unit area of mesh has also been worked out. This discharge rate is sufficient to contain the roof water inflow expected for high rainfall intensities.

Table 4.12 Discharge rate of different filters

Mesh size (μ)	volume (l)	Time(s)	Discharge rate per (l/ s)	Mean discharge (l/s)	Unit discharge (lps/m²)
60	35	28	1.25	1.15	24.38
	35	32	1.09		
	35	31	1.12		
40	35	38	0.92	1.13	23.95
	35	29	1.2		
	35	27	1.29		
25	35	40	0.87	0.85	18.02
	35	42	0.83		
	35	40	0.87		
15	35	44	0.79	0.72	15.26
	35	52	0.67		
	35	49	0.71		
12	35	60	0.58	0.6	12.72
	35	56	0.62		
	35	58	0.6		
7	35	59	0.59	0.56	11.87
	35	55	0.63		
	35	75	0.46		
5	35	71	0.49	0.43	9.11
	35	80	0.43		
	35	90	0.38		
3	35	86	0.4	0.37	7.84
	35	95	0.36		
	35	98	0.35		

SUMMARY AND CONCLUSIONS

Rooftop rainwater harvesting is a green technology which is most eco-friendly and adaptable to a wide range of conditions. Its potential in solving domestic water scarcity is highly worth noting. In areas where there is variations in the seasonal rainfall pattern, the balancing of water supply and demand would be difficult. In such cases roof water harvesting can play a very vital role. However, rainwater interacting with the roof surfaces become impure due to the presence of contaminants like bird droppings, dust, dirt, leaves and growth of algae and mosses on the rooftop. Therefore, the filtration of roof water requires great attention.

The commonly used filter system in roof water harvesting is the sand and gravel one and is prone to clogging at closer intervals and has been proved to be a failure in most cases. The upward flow micro mesh filters developed as an alternative to the sand and gravel filter needs further improvisation in terms of percentage removal of suspended matter and the high frequency flush out of filtered out impurities to avoid the decay of organic matter within the filter system. The positive impact of a first flush system is also worth investigating scientifically. Under these circumstances, this M.Tech research work has been taken up with the following specific objectives.

- To assess the performance of upward flow mesh filters of different mesh sizes under actual rainfall condition.
- To evaluate performance of first flush system under actual rainfall condition.
- To develop an automatic cleaning mechanism for upward flow mesh filter and its evaluation.

The study included the performance evaluation of eight different sized micro mesh upward flow filters (60, 40, 25, 15, 12, 7, 5 and 3 micron) for purifying the roof water, evaluation of first flush system and the development of an efficient automatic cleaning mechanism for upward flow filters. Roof water samples were collected from the inlet and outlet side of the filter system and analysed for pH, EC, TDS, SAL, TSS, filtration efficiency and filtration rate.

The study revealed that pH of the inflow and outflow roof water samples were varying within the limits of 6.0 to 7.5 excluding some outliers. pH of outflow samples did not show any significant difference from that of inflow in the case of all the filters tested. Electrical conductivity (EC) of the inflow roof water samples were within the range of 114 to 160 μ s/cm. Whereas, outflow roof water samples of mesh filters were within the range of 40 to 130 μ s/cm with a reduction of about 50% in 5 and 3 micron meshes and 10 to 15 % in other mesh sizes.

TDS values of the outflow roof water samples of the micro mesh filters were ranging from 40 to 85 ppm. Variations in TDS between inflow and outflow were not well distinguishable. The result is in the expected line as chances of dissolved impurities getting removed by mesh filtering is less. Salinity of the outflow water samples were within range 0.01 to 0.08. Here, inflow and outflow samples showed significant variation in the case of 5 and 3 micron mesh filters and in other cases the difference was insignificant. TSS, the most objectionable being mostly organic in nature, was within the range of 220 to 280 mg/l in inflow samples. Filtration reduced the TSS values to about 100% in 3 micron, 97% in 5 micron, 89% in 7 micron and this value decreases to 73% in the case of 60 micron meshes. Major parts of suspended materials were organic matter derived from mosses, algae and other vegetative growth and its presence was very higher than the permissible limits set by WHO and BIS. The results of TSS removal in the case of 3 micromesh filter was highly encouraging and worth noting.

The first flush system was able to collect 20 l of initial most impure water generated and was capable of diverting it from the filter system and thereby reducing the impurities load on it. Impure water collected in the first flush tank was not getting mixed with the relatively cleaner roof water passing through after the initial period. Use of first flush in combination with mesh filters showed beneficial results in removing the suspended impurities (about 20 percentage decrease) in the case of 60, 40 and 25 μ mesh filters.

The automatic flush system developed with solenoid valve, light sensor and electronic circuit was capable of opening the valve for about 10 seconds once a day.

The results showed that automatic flush was removing 92% of the retained impurities after filtration on the inlet side of the micro mesh filter.

The study leads to the following conclusions:

1. The micro mesh filter was capable of reducing the EC and TSS of the rooftop water. The 3 micron filter showed best performance in reducing TSS and it completely eliminated the TSS. This result can be cited as an outstanding achievement of this study.
2. First flush system in combination with the mesh filter in the case of coarser filters showed positive impact. First flush significantly reduces the impurities load in inflow water going to the micro mesh filter.
3. Filtration rate of mesh filters were sufficient for roof water harvesting, even 3 μ mesh gave a filtration rate of 0.37 l/s at a hydraulic head of 1.5 m.
4. It can be concluded that 3 micron mesh filter with automatic flush can function as a fool proof mechanism for filtering rooftop rain water.

The following future scope of work can be suggested;

The clogging rate of different micro mesh filters and their reduction in filtration rate may be studied

REFERENCES

- Agarwal, R. and Sunil, G. 2010. Impact of rooftop rainwater harvesting for ground water recharge. *J. Agric. Eng.* 47: 46-48.
- Beckman, D.S. and Devine, J. 2011. Capturing rainwater from rooftops: an efficient water resources management strategy that increases supply and reduces pollution. Natural Resources Defence Council, Los Angeles.
- Brock, D. and Kate, L. 2008. Roof water harvesting for a low impact water supply featuring the Brazilian Ball Pre-Filter system. *Watershed advocacy training educ. res.*
- Bolton., James., Colton., and Christine. 2008. The Ultraviolet Disinfection Handbook. American Water Works Association. pp. 3-4.
- Crabtree, K.D., Ruskin, R.H., Shaw, S.B., and Rose, J.B. 1996. The Detection of Cryptosporidium Oocysts and Giardia Cysts in Cistern Water in the U.S. Virgin Islands. *Water Sci. Technol.* 30: 208-216.
- Chandel, R.S. and Sharma, M.R. 2014. Potential and Limits of Domestic Rooftop Water Harvesting in Una Area of Shiwalik Hills. *Asian J. of Adv. Basic Sci.* 3(1): 28-35.
- Constantin, N., Sorin, C., Roxana, D.B., Floarea, B., and Gheorghe, S. 2010. System of Rainwater Collection, Storage and Pumping. *J. Food. Agric. Environ.* 8(3&4): 1332-1334.
- Dinesh K, M. 2004. Roof water harvesting for domestic water security: who gains and who loses. International Water Management Institute, Gujarat, India. *Water Int.* (29): 43-53.
- Dwivedi, A.K. and Bhadauria S.B. 2004. Domestic rooftop water harvesting. *J. Eng. Appl. Sci.* 4: 31-38.
- EA [Environment Agency]. 2010. Harvesting rainwater for domestic uses: an information guide. Available: [http:// www.environmentagency. gov.uk](http://www.environmentagency.gov.uk), pp. 15- 18.

- Evans, C.A., Coombes, P.J., and Dunstan, R.H. 2006. Wind, rain and bacteria: The effect of weather on the microbial composition of roof-harvested rainwater. *J. Water Res.* 40: 37 - 44.
- Fayez, A.A. and Al-Shareef, A.W. 2009. Roof rainwater harvesting systems for household water supply in Jordan. *Desalination.* 243: 195-207.
- Farreny, R., Morales-Pinzo, T., Guisasola, A., Taya, C., Rieradevall, J., Gabarrell, X. 2011. Roof selection for rainwater harvesting: Quantity and quality assessments in Spain. *Water Res.* 45: 3245-3254.
- Gadgil, M., Berkes, F., Kislalioglu, M., and Folke, C. 1998. Exploring the Basic Ecological Unit: Ecosystem-like Concepts in Traditional Societies. *Ecosyst.* 1: 409-415.
- Helmreich, B. and Horn, H. 2008. Opportunities in rainwater harvesting. IWQC, Germany. pp. 118-124.
- Herngren, L., Ashantha, G., and Godwin, A. 2004. Investigation of urban water quality using artificial rainfall. 24-25 June 2004.
- Jain, R.K., Singh, H., Amar, V., Sagar, B., and Deepak, S. 2015. Study of Water Distillation by Solar Energy in India. *Int. J. Mech. Eng. Inf. Technol.* 1004-1009.
- Jyothison, G., Lakshmi, D.S., and Sreesha, P. 2002. Assessment of roof water harvesting potential and recharge pit design. Unpublished B.Tech project report, KCAET, KAU, Tavanur, Malappuram, Kerala.
- Kahinda, J.M., Taigbenu, A.E., and Boroto, J.B. 2007. Domestic rainwater harvesting to improve water supply in rural South Africa. *J. Phys. Chem. of the Earth.* 32: 1050-1057.
- Kaposztasova, D., Vranayova, Z., Markovic, and Purczb, P. 2014. Rainwater harvesting, risk assessment and utilization in Kosice- city, Slovakia. *J. Procedia Eng.* 89: 1500 -1506.

- Krishna, K.C., Sathasivan, A., and George, K. 2014. Effectiveness of breakpoint chlorination to reduce accelerated chemical chloramine decay in severely nitrified bulk waters. *J. Chemosphere*. 117. 692-700.
- Lee, Y., Bak, G., Han, M. 2012. Quality of roof-harvested rainwater- comparison of different roofing materials. *Environ. Pollut.* 162: 422- 429.
- Manoj, P.S. and Mathew, A.C. 2008. Rejuvenation of water bodies by adopting rainwater harvesting and groundwater recharging practices in catchment area- a case study. *ICAR CPCRI*. Pp.1-11.
- Manzurul, I., Kabir. M.R., and Frederick, N.C. 2007. Feasibility study of rainwater harvesting techniques in Bangladesh. Dept. of Civil Engineering, University of Asia Pacific, Dhaka, Bangladesh.
- Mendez. C.B., Brandon, K., and Brigit R.A. 2011. The effect of roofing material on the quality of harvested rainwater. *J. Water Res.* 45: 2049 -2059.
- Rahmat, S., Zarina M., sabariah, M. (2008). Treatment of rainwater quality using sand filter. *Int. Conf. on Environ.*
- Rajan, S. 2001. Making water everybody's business practices and policy of water harvesting. pp. 122-124.
- Rangwala, S.C. 2003. Water supply and sanitary engineering. *Charotor publishing house*, Anand Publishers. pp. 115-160, 595-600.
- Rana, S. 2002. Rain water harvesting for drinking in rural area (A case study on three villages of Paikgacha Thana in Khulna District). Town Planner Meherpur.
- Reena, K. and Sherring, A. 2012. Planning and cost estimation of roof rainwater harvesting structure. *Int. J. Agric. Environ. Biotechnol.* 5(3): 225-232.
- Rebeix, R., Lasalle, L.G., Baptiste, J.P., Lavastre, V., Fourré, E., Bensenouci, F., and Lancelot, J. 2014. Chlorine transport processes through a 2000 m aquifer/aquitard System. *Mar. Pet. Geol.* 53, 102-116.

- Rishab, T., and Deepak, B.M. 2007. Use of water harvesting as an effective tool for water management. *J. Environ. Manag.* 132: 178-187.
- Sarala, C. 2012. Domestic wastewater treatment by electrocoagulation with Fe-Fe electrodes. *Int. J. Eng. Trends Technol.* 3(4): 401-430.
- Sharma, S. K. 2007. Roof – top rainwater harvesting technique in an urban area - a case study from India. Geological Research Institute 24 National Road, Dehradun 248001, India.
- Shadeed, S. And Lange, J. 2010. Rainwater harvesting to alleviate water scarcity in dry conditions: A case study in Faria Catchment, Palestine. *J. Water Sci. Eng.* 3(2): 132-143.
- Shivakumar, A. R. 2006. Rainwater harvesting from rooftops. Karnataka State Council for Science and Technology (KSCST).
- Susumu, K., Shunsuke, H. And Masaaki, I. 2001. Physicochemical speciation of molybdenum in rain water. *J. Water Res.* 35(10): 2489-2495.
- Tamim, Y., Rebecca, B., Eric, A., Kelly, R., Nicole, C., Blake, R., and Theo, D. 1998. Evaluation of rooftop rainfall collection-cistern storage systems. Virginia Water Resources Research Centre, 9-49.
- Taser, T.M. 2014. Quantity and quality considerations of rooftop rainwater harvesting as a substantial resource to face water supply shortages. *Int. J. Water Res. and Arid Environ.* 3(1): 01-10.
- Thomas, T.H. and Martinson, D.B. 2007. Roof water harvesting: a handbook for practitioners. IRC International Water and Sanitation Centre. (Technical Paper Series; no. 49), Netherland. 160 p.
- UNICEF. 2004. Evaluation of the rooftop rainwater harvesting project. Water Environment and Sanitation Section, New Delhi, India. pp. 1-6.
- Vanreis, R. and Zydney, A. 2007. Bioprocess membrane technology. *J. Mem. Sci.* 297: 16-50.

- Visalakshi, K.P., Reena, M., and Raneesh, K.Y. 2006. Rain water harvesting in KAU – a safe guard against the water crisis of the campus, Kerala, India. pp. 05-41.
- Ward, S., Memon, F A., and Butler, D. 2010. Harvested rainwater quality: the importance of appropriate design. *Water Sci. & Tech.* 61(7): 1707-1714.
- Wolfe, R.L. 1990. Ultraviolet disinfection of potable water. *J. Env. Sci. Technol.* 24 (6): 768-773.
- Yaziz, M.I., Gunting, H., Sapari, N., and Ghazali, A.W. 1989. Variations in rainwater quality from roof catchments. *J. Wat. Res.* 23(6): 761-765.
- Ying, L.K. and Sunny, C.J. 2013. Revaluation of health risk benchmark for sustainable water practice through risk analysis of rooftop-harvested rainwater. *J. Wat. Res.* 47: 7273-7286.
- Zhe, L., Fergal, B., and Anthony, R. 2010. Rainwater harvesting and greywater treatment systems for domestic application in Ireland. *J. Desalination.* 260: 1-8.

Appendix-I

1. Concentration of impurities (g/100l) with and without flush out

Sample	Weight of filter paper (g)	Weight of filter paper with samples of without flush out after drying (g)	Concentration of suspended solids in without flush out (g/100l)	Weight of filter paper with samples of with flush out after drying (g)	Concentration of suspended solids in with flush out (g/100)	Amount of impurities removed through flush out (g/100l)
1	0.860	18.59	35.46	2.67	3.62	31.84
2	0.860	19.85	37.98	2.42	3.12	34.86
3	0.860	19.55	37.38	2.38	3.04	34.34

**DEVELOPMENT OF AN AUTOMATIC CLEANING MECHANISM FOR
ROOF WATER HARVESTING**

By

LAKSHMINARAYANA S. V.

(2014 - 18 - 114)

ABSTRACT OF THE THESIS

**Submitted in partial fulfilment of the
requirement for the degree of**

MASTER OF TECHNOLOGY

IN

AGRICULTURAL ENGINEERING

(Soil and Water Engineering)

Faculty of Agricultural Engineering & Technology

Kerala Agricultural University



**DEPARTMENT OF LAND & WATER RESOURCES AND CONSERVATION ENGINEERING
KELAPPAJI COLLEGE OF AGRICULTURAL ENGINEERING AND TECHNOLOGY**

TAVANUR- 679573, KERALA

2016

ABSTRACT

One of the easiest and efficient way of water conservation to solve drinking water scarcity is rooftop water harvesting. However, the technology has some limitations with regard to its purification system. The commonly used sand and gravel filter is very prone to clogging and its cleaning is not an easy job. At the same time, the alternative upward flow mesh filter needs further improvement in cleaning efficiency and some hassle free drain cum back washing mechanism. Hence, a study has been taken up on the upward flow filter system to improve its filtration efficiency and incorporate an automated drain cum back washing mechanism. The study also included the performance evaluation of a first flush system when attached to the inlet side of the micro mesh filter.

To evaluate the performance of the filter and first flush, inflow and outflow of the rooftop water samples were analysed for pH, EC, TDS, SAL and TSS parameters. In general, the PH, electrical conductivity, and TDS of the roof water samples were within the drinking water standards and the filter system was found to reduce TDS values. In the case of TSS, mostly the impurities were organic in nature and concentration varied between 220 to 280 mg/l, a level much higher than WHO and BIS standards. The 3 micron mesh filter is removing 100% of the organic TSS impurities. The filtration rate of this filter is about 0.37 lps at a hydraulic head of 1.5 m and hence suites to rooftop rain water harvesting. First flush system showed better cleaning efficiency when attached to the inlet side of the coarser micro mesh filters. Automatic flush developed for the removal of stagnant water with impurities were performing well by removing all the stagnant water and about 92 % of the impurities. It can be concluded that 3 micron mesh filter with automatic flush can function as a near fool proof mechanism for filtering rooftop rain water.