

**DEVELOPMENT AND EVALUATION OF A SOLAR POWERED AUTOMATED  
FERTIGATION SYSTEM**

by

**ANJALY C SUNNY**  
(2014 - 18 - 106)

THESIS

Submitted in partial fulfilment of the  
requirement for the degree of  
**MASTER OF TECHNOLOGY**

IN

**AGRICULTURAL ENGINEERING**  
(Soil and Water Engineering)

Faculty of Agricultural Engineering & Technology  
Kerala Agricultural University



**DEPARTMENT OF LAND AND WATER RESOURCES CONSERVATION  
ENGINEERING**  
KELAPPAJI COLLEGE OF AGRICULTURAL ENGINEERING AND TECHNOLOGY

TAVANUR - 679573, MALAPPURAM

KERALA, INDIA

2016

## DECLARATION

I hereby declare that this thesis entitled "Development and evaluation of a solar powered automated fertigation system" is a bonafide record of research done by me during the course of research and that the thesis has not previously formed the basis for the award of any degree, diploma, fellowship or other similar title of any other University or Society.

Tavanur,

Date:

Anjaly C  
Sunny  
(2014- 18 -  
106)

## CERTIFICATE

Certified that this thesis, entitled “Development and evaluation of a solar powered automated fertigation system” is a record of research work done independently by Miss. Anjaly C Sunny (2014 - 18 - 106) under my guidance and supervision and that it has not previously formed the basis for the award of any degree, diploma, fellowship or associateship to her.

Tavanur,  
Date:

**Dr. Abdul Hakkim, V. M.**  
Professor and Head  
Départment of LWRCE  
Kelappaji College of Agricultural  
Engineering & Technology,  
Tavanur, Malappuram- 679573

## CERTIFICATE

We the undersigned members of the Advisory Committee of Miss. Anjaly C Sunny (2014 - 18 - 106) a candidate for the degree of Master of Technology in Agricultural Engineering, agree that the thesis entitled "Development and evaluation of a solar powered automated fertigation system" may be submitted by Miss. Anjaly C Sunny, in partial fulfilment of the requirement for the degree.

**Dr. Abdul Hakkim, V. M.**  
(Chairman, Advisory Committee)  
Professor and Head  
Département of LWRCE  
KCAET, Tavanur

**Dr. Sathian, K.K.**  
(Member, Advisory Committee)  
Professor  
Dept. of LWRCE  
KCAET, Tavanur

**Dr. Rema, K.P.**  
(Member, Advisory Committee)  
Professor  
Dept. of IDE  
KCAET, Tavanur

**Dr. Musthafa Kunnathadi**  
(Member, Advisory Committee)  
Assistant Professor  
ARS, Anakkayam

EXTERNAL EXAMINER

## ACKNOWLEDGEMENT

*And so comes the time to look back on the path traversed during the endeavour and to remember the faces and spirits behind the action with a sense of gratitude. Nothing of significance can be accomplished without the acts of assistance, words of encouragement and gestures of help from the other members of the society.*

*It is with immense pleasure I avail this opportunity to express my deep sense of whole hearted gratitude to my major advisor **Dr. Abdul Hakkim, V. M.**, Professor and Head , Département of LWRCE, KCAET, Tavanur, for his excellent guidance, caring, patience, financial support for the work and providing me with an excellent atmosphere for doing research. I consider it my greatest fortune in having his guidance for my research work and my obligation to him lasts forever.*

*I express my heartfelt thanks to **Dr. Haji Lal, M.S.**, Dean, KCAET, Faculty of Agricultural Engineering and Technology for support that he offered while carrying out the project work. My sincere thanks to **Dr. M. Sivaswami**, Former Dean, KCAET, Faculty of Agricultural Engineering and Technology for the unfailing guidance and support that he offered while carrying out the project work.*

*I express my deep sense of gratitude and indebtedness to my advisory member **Dr. Musthafa Kunnathadi**, Assistant Professor, ARS Anakkayam. I am thankful for his valuable advices, creation of immense interest in the subject, fatherly approach and constant encouragement during every phase of my thesis work.*

*I engrave my deep sense of gratitude to my advisory committee members **Dr. Rema, K.P.** Professor, Department of Irrigation and Drainage Engineering, KCAET, Tavanur, for her help, valuable suggestions, evaluation and due encouragement during the entire period of the project work and **Dr. Sathian, K.K.**, Professor, Dept. of LWRCE, KCAET, Tavanur for his valuable advice and moral support provided during the project work.*

*I have boundless pleasure in recording my profound thanks to **Mr. Jubail** , Farm Manager, ARS Anakkayam, for his expert advice, inspiring guidance, valuable suggestions, constructive criticisms, affectionate advice and above all, the extreme patience, understanding and wholehearted co-operation throughout the project work.*

*My sincere thanks to **Ms. Shahidha**, Farm Manager, ARS Anakkayam for her valuable suggestions, encouragement and caring. I also would like to thank my beloved Research Associates **Likhitha P.N., Shirona, Akhila Jayesh, Mufeedha, Dr. Abhilash and Bronisha** and teaching assistant **Ajay Gokul** for their wonderful help and encouragement during the entire period of the project work.*

*I would fail in my duty if I miss to thank **Mrs. Sunathi Roy**, Skilled Assistant, ARS, Anakkayam and **Mrs. Subheesh, T.P.**, labour, ARS, Anakkayam, for their moral and physical support for the successful conduct of experiment in time. I am extremely thankful to all the*

labourers attached especially **Mr. P.K. Sundharan** for his co-operation and support during the conduct of the lab experiment.

My special and sincere thanks to **Dr. Surendran, U.**, Scientist, CWRDM for his moral and research support during my research work and I offer my special thanks to **Er. Jinu, A.**, for his moral support and valuable suggestions.

My heartfelt thanks to my beloved teacher, **Dr. Asha Joseph**, Assistant Warden, LH KCAE, Tavanur, for granting me permission to stay at Anakkayam during the course of my study.

With great pleasure I express my heartfelt special thanks to my **batch mates** for their support, encouragement and enthusiastic cooperation from time to time for the each step of my thesis work. I wholeheartedly thank my loving friends **Tintu, Bijan, Mubeena, Teena, Rashid, Arjun, Aswin, Anju and Rohith** for their love, caring, encouragement and moral support which helped me get over all odds and tedious circumstances.

I am in dearth of words to express my soulful gratitude to my loving **parents** and my beloved sister **Ardhra** for their blessings, selfless support, boundless patience, prayers, inspiration, sacrifices, unflagging interest and eternal love which sustains peace in my life. I am forever indebted to my loving brother **Aby, V.P.**, without whose blessings and support I would not have completed this work.

I express my deep sense of gratitude to **Kerala Agricultural University** for financial and technical support for persuasion of my study and research work.

It would be impossible to list out all those who have helped me in one way or another in the successful completion of this work. I once again express my heartfelt thanks to all those who helped me in completing this venture on time.

Above all, I thank to “**The Almighty God**” for his blessing and procurement, which helped me in the completion of the endeavour.

**Anjaly C Sunny**

## CONTENTS

---

<b>Chapter No.</b>	<b>Title</b>	<b>Page No.</b>
	LIST OF TABLES	ix
	LIST OF FIGURES	xi
	LIST OF PLATES	xiii
	LIST OF APPENDICES	xiv
	SYMBOLS AND ABBREVIATIONS	xv
I	INTRODUCTION	1
II	REVIEW OF LITERATURE	5
III	MATERIALS AND METHODS	29
IV	RESULT AND DISCUSSION	56
V	SUMMARY AND CONCLUSION	77
	REFERENCES	85
	APPENDICES	

### LIST OF TABLES

Table No.	Title	Page No.
2.1	Fertilizer solubility and temperature (g/100g of water)	11
2.2	Fertilizer compatibility chart	13
2.3	Corrosivity of fertilizers	14
2.4	Comparison of fertigation equipments	20
3.1	Specifications of FIP	32
3.2	Specification of a float switch	39
3.3	Specification of a polyhouse	37
4.1	Average pumping rate of the pumps	57
4.2	Total amount of fertilizer required in each plot	57
4.3	Total amount of water to be filled initially in each fertilizer tank	58
4.4	Energy consumption rate of various components	59
4.5 (a)	Influence of different treatments on plant height of cucumber at first two stages	61
4.5 (b)	Influence of different treatments on plant height of cucumber at later stages	62
4.6	Date of occurrence of differing flowering parameters	62
4.7	Influence of different treatments on LAI of cucumber plant at three stages of growth	64
4.8	Influence of different treatments on number of fruits per plant of the cucumber	66
4.9	Influence of different treatments on weight of the cucumber fruit	68
4.10	Influence of different treatments on length of the cucumber fruit	70



4.11	Influence of different treatments on equatorial circumference of the cucumber	72
4.12	Influence of different treatments on yield of the cucumber fruit	74

## LIST OF FIGURES

<b>Figure No.</b>	<b>Title</b>	<b>Page No.</b>
2.1	Ventury injector	17
2.2	Fertilizer pump	18
2.3	Fertilizer tank	19
2.4	Fertigation control system	25
2.5	The concept of computer-based fertigation system	26
3.1	Logical circuits in the system	30
3.2	Fertilizer tank	31
3.3	Connection diagram of a timer	33
3.4	Connection diagram of a single relay board	35
3.5	Connection diagram of a 4- channel relay board	39
3.6	Float Switch	40
3.7	Key functions of a timer	42
4.1	Influence of different treatments on plant height of cucumber at different stages of growth	61
4.2	Date of events related to cucumber growth as influence by different treatments	63
4.3	Influence of different treatments on LAI of cucumber plant at three stages of growth	65
4.4	Influence of different treatments on number of fruits per plant of the cucumber	67
4.5	Influence of different treatments on weight of the cucumber fruit	69
4.6	Influence of different treatments on length of the cucumber fruit	71
4.7	Influence of different treatments on equatorial	72

	circumference of the cucumber	
4.8	Influence of different treatments on yield of the cucumber fruit	75

## LIST OF PLATES

<b>Plate No.</b>	<b>Title</b>	<b>Page No.</b>
3.1	Solar panel	38
3.2	Wooden casing	40
3.3	Control circuit	40
3.4	Timer	40
3.5	Level indicators	40
3.6	Polyhouse	47
3.7	Layout in polyhouse	49
3.8	Layout in open field	49
3.9	Seedlings in the protray before transplanting	49
3.10	Fertilizer tank along with mixing tank and FIP arrangement	50
3.11	Cucumber plants	52
3.12	Harvested fruits	52
3.13	Sowing	54
3.14	Germination	54
3.15	Transplanting	54
3.16	Budding	54
3.17	Flowering	54
3.18	Fruiting	54
4.1	Crops in plot T <sub>1</sub>	73
4.2	Crops in plot T <sub>2</sub>	73
4.3	Crops in plot T <sub>3</sub>	73
4.4	Comparison of fruit size	73

**LIST OF APPENDICES**

---

<b>Appendix No.</b>	<b>Title</b>	<b>Page No.</b>
I	Fertigation schedule inside automated polyhouse with 186 plants	80
II	Fertilizer schedule for control plots with 24 plants each	82
III	Calculation of amount of fertilizer required	83

## SYMBOLS AND ABBREVIATIONS

---

°C	: Degree Celsius
%	: Percent
+	: Plus
-	: Minus
>	: Greater than
ARS	: Agricultural Research Station
ADC	: Analog to Digital Converter
Cm	: Centimetre
CLOSYS	: CLOsed SYStem for water and nutrient management
CCD	: Charge coupled device
CPU	: Central Processing Unit
DC	: Direct Current
<i>et al.</i> ,	: And co workers
EC	: Electrical Conductivity
EU	: European Union
FYM	: Farm Yard Manure
FDR	: Frequency Domain Reflectometer
FIP	: Fertilizer Injection Pump
GI	: Galvanized Iron
Ha	: Hectare
HP	: Horse Power

H	: Hours
KAU	: Kerala Agricultural University
KCAET	: Kelappaji College of Agricultural Engineering and Technology
Kg	: Kilogram
kg/ha	: Kilogram per hectare
L	: Litre
LAI	: Leaf Area Index
LCD	: Liquid Crystal Display
LDPE	: Low Density Polyethylene
LLDPE	: Linear Low Density Polyethylene
Lph	: Litre Per Hour
MAP	: Mono ammonium phosphate
MCU	: Micro Controller Unit
ml/l	: Millilitre/Litre
Mm	: Millimetre
N	: North
NCEA	: National Centre for Engineering in Agriculture
pH	: Negative logarithm of hydrogen ion
PVC	: Poly Vinyl Chloride
S	: Second
TDR	: Timer Domain Reflectometer
t/ha	: Tonnes per hectare
UV	: Ultra Violet

---

## **CHAPTER I**

### **INTRODUCTION**

India has to increase the area under production, conserve water and other natural resources to meet the food and fibre demand in contend with the increasing rate of population growth. Farmers today are confronted with the challenge of meeting an ever increasing demand of high quality and safe food. In any case, these demands must be fulfilled in economically feasible ways, whilst protecting natural resources and shielding the environment. Water, supplements, energy and work are basic determinants of farm efficiency and profit.

Because of the importance and advantages of issues related to excess, shortage and quality deterioration, water as a source requires unique consideration. Present water resource scenario in India, in terms of both quality and quantity, warns and demands for the judicious usage of water in the coming years. The past way to deal with water management in India is no more justifiable as the crevice between the demand of water resources and renewability of resources is getting limited.

While the irrigation projects have added to the improvement of water resources, the ordinary techniques for water transport and irrigation being exceedingly wasteful, has not only prompted wastage of water but also have given way to few natural issues like water logging, salinization and soil degradation making beneficial farming grounds inefficient. It has been perceived that the utilization of advanced irrigation system strategies like drip and sprinkler system is the main choice for the effective utilization of surface and ground water resources.

Simca Blass, a water engineer started drop by drop application of water to the plants through drip irrigation system in the early 1940's, in Israel. Thereafter this system of irrigation got established in countries like America, Australia, South



Africa, Southern Europe etc (Alam and Kumar, 1980). In India it was introduced in the early 70's and during the last few years this system has started gaining momentum and about 4 lakh ha of cultivated lands in India utilize this system of irrigation. Among different states, Maharashtra is the leading state covering 6,04,440 ha under micro irrigation followed by Andhra Pradesh with 5,05,205 ha and Tamil Nadu with 2,26,773 ha as on March 2010. It is also expected that the projected area of 10 M ha will be brought under micro irrigation by the year 2020 / 2025 AD. About 55 per cent of the total area of Kerala State with a humid tropical climate is under agriculture. As per the records of Directorate of Economics and Statistics, the gross area irrigated in the state as on March 2010, was 4.54 lakh ha and the net area irrigated was 3.86 lakh ha. The net area irrigated has declined from 3.99 lakh ha during 2008-09 to 3.86 lakh ha in 2009-10 and only 16.34 per cent of the net cropped area is irrigated. The area under micro irrigation in Kerala is as low as 15,885 ha (2010). Hence, there is still ample scope, for this method of irrigation in Kerala. Endeavours were made in India to present micro irrigation system framework in farmer's level around 1980. In the past 25 years, micro irrigation system has taken up its energy from around 1500 ha in 1955 to more than 0.5 million ha at present (Narayanamoorthy, 2006).

Expansion of agriculture through irrigation and increased usage of fertilizers may create contamination by expanded levels of nutrients in underground and surface water. Demands for the need for a more efficient method for fertilizer application occurred due to some reasons like mining of nutrients from the soil at alarming rates, decline in crop response to fertilizer, non uniformity in fertilizer consumption and therefore non uniformity in production. However, weakening relationship between fertilizer use and food grain production, soil fertilizer depletion due to inadequate and imbalanced use of fertilizer added up the demand of improved techniques of fertilizer application over conventional methods. Accordingly judicious management of plant supplements accessible through various fertilizers should be catered. Progressed scientific techniques for drip and sprinkler irrigation system and real time sensor

based scheduling can be utilized to upgrade water use efficiency and fertilizer use efficiency as the system is placed around the plant roots uniformly, which allows rapid uptake of nutrients by the plant.

The adoption of fertigation by farmers largely depends on the benefits derived from it and in Kerala, the fertigation is in its introductory stage. Its success in terms of improved production depends upon how efficiently plants take up the nutrients. Proper scheduling and intervals are also needed to provide nutrients at a time when plants require them. The adoption of fertigation worldwide has shown favourable results in terms of fertilizer use efficiencies and quality of produce besides the positive environmental impacts. The choice of selecting various water soluble fertilizers are wide and therefore, selection should be based on the property of avoiding corrosion, softening of plastic pipe network, solubility in water and safety in field use.

Automated fertigation system is a highly advanced system of drip automation for water and fertilizer administration in agriculture. It promises the application of water in right quantity with right fertilizer at right time, reducing the cost of labour thereby saving money with the help of an automated mechanism. Use of an automated fertigation system can help producers to make correct choices that can essentially affect water and fertilizer utilization and can decrease fertilizer lose. Some automated systems are capable of integrating irrigation scheduling with nutrient dosing activities while other systems only manage the nutrient dosing equipment.

The present study was undertaken to develop an automated fertigation system and to evaluate its performance. The developed system is powered completely by solar energy and its effectiveness is also tested to control the fertilizer mixing process and injection of nutrient solutions at various growth stages of the crop. The specific objectives of the study are:

1. Development of a solar powered automated fertigation system.

2. To evaluate the performance of the developed automated fertigation system in the laboratory.
3. Field evaluation of the developed solar powered automated fertigation system inside a poly house with salad cucumber crop.

## CHAPTER II

### REVIEW OF LITERATURE

Irrigation plays an important role in agriculture. Crop yield can be increased through irrigation at suitable time intervals in correct proportions. However, high labour cost has given way for the prominence of automated irrigation systems. For any crop, to get maximum yield scheduled fertilizer application is highly inevitable. Drip irrigation along with fertigation helps in saving of water and fertilizers and at the same time increases the quantity and quality of produce (Vargheese *et al.*, 2014).

#### 2.1 Drip irrigation and its advantages

Drip irrigation is the most efficient method to provide water at the required rate near the root zone of the crop. Drip irrigation is one such hi - tech system, receiving acceptance and adoption, especially in areas of water scarcity.

Haynes (1985) illustrated that the drip or daily irrigation has been developed particularly for conditions of intensive irrigated agricultural and horticultural production and it has gained wide acceptance not only because it conserves water but also it allows more effective management of water or fertilizer applications than do other irrigation techniques.

Nakayama and Bucks (1991) found that high soil metric potential in the root zone is maintained with the help of high frequency water management by drip irrigation. It provides daily requirements of water to a portion of the rhizosphere of each plant and reduces plant water stress.

Major advantages of drip irrigation include the slow delivery of water on immediately above or below the surface of the soil which helps in minimizing water loss due to runoff, evaporation and wind and moreover it reduces the weed growth. Increased water use efficiency of drip irrigation results in better quality crop yield, which is uniform and it is this uniformity which makes it suitable for automation. It causes minimum damage to the soil structure and it also permits the

usage in undulating areas and slow permeable soil. The mould spots, staining and deterioration experienced with overspray from sprinkler irrigation can be eliminated with the use of drip. It also reduces the foliar disease incidence compared to overhead irrigation methods (Hochmuth and Smajestrta, 2003).

The low volume requirements of drip irrigation favours water application in water scarce areas. An AC (Alternating Current) or battery powered controller is enough to manage a drip system. Above all, it requires less labour and energy. However, precipitation, salt accumulation and clogging stands are demerits of this system of irrigation (Wilson and Bauer, 2005).

### **2.1.2 Impact of drip irrigation on growth and yield of crop**

Singh *et al.* (2000) made an attempt to study the effect of drip irrigation compared to conventional irrigation on growth and yield of Apricot to work out its irrigation requirement. Drip irrigation at 80 per cent evapotranspiration of water gave significantly higher growth and fruit yield of 8.6 tonnes per hectare compared to the surface irrigation. Plastic mulch plus drip irrigation further raised the fruit yield to 10.9 tonnes per hectare. Drip irrigation besides saving 98 per cent irrigation resulted in 3.3 metric tonnes per hectare higher fruit yield.

Ashokaraja and Kumar (2001) conducted studies on Micro irrigation which proved drip irrigation to be an effective tool for conserving water resources. The studies revealed that 40 to 70 per cent water saving was achieved by drip irrigation compared to surface irrigation and in some crops in specific location yield increased as high as 100 per cent.

The response of potato under drip irrigation and plastic mulching was studied by Jain *et al.* (2001). The highest water use efficiency was found to be 3.24 t/ha- cm for the treatment irrigated with drip system at 80 per cent level with mulch as compared to 2.17 t/ha-cm control treatment.

Narayanamoorthy (2001) illustrated the benefits of micro-irrigation in terms of water saving and productivity gains were substantial in comparison to the

same crops cultivated under flood method of irrigation. Apart from being beneficial to the farmers, irrigation development also helps to increase the employment opportunities and wage rate of the agricultural landless labourers, both being are essential to reduce the poverty among the landless labour households.

The water requirement, yield and economics of drip irrigation in litchi were studied by Singh *et al.* (2001) at farmer's field in Uttar Pradesh. It was found that good quality marketable yield of litchi varied from 12.5 to 16 metric tonnes per hectare for drip system. The total volume of water applied was 282 mm for drip irrigation during four months of system operation. The benefit cost ratio of drip irrigated litchi was found to be 3.91 and for surface irrigated litchi it was 3.05.

The response to urea fertilizer with drip irrigation and compared with conventional furrow irrigation for two years. Application of nitrogen through the drip irrigation in ten equal splits at eight days interval saved 20- 40 percentage nitrogen compared to the furrow irrigation when it was applied in two equal split. Similarly, higher fruit yield of 3.7 to 12.5 per cent was obtained with 31 to 37 per cent saving of water by the drip system. Water use efficiency in drip irrigation, nitrogen level was 68 and 77 per cent on an average higher over surface irrigation in 1995 and 1996, respectively. At a nitrogen application rate of 120 kg/ha, maximum tomato fruit yield of 27.4 and 35.2 tonnes per hectare in two years was recorded (Singhandhube *et al.*, 2003).

Bozkurt and Mansuroglu (2009) conducted studies to investigate the effects of drip irrigation methods and different irrigation levels on quality, yield and water use characteristics of lettuce cultivated in solar green house. The result obtained revealed that the highest yield was obtained from subsurface drip irrigation at 10cm drip line depth and 100 per cent of Class A Pan Evaporation rate treatment. The water use efficiency and irrigation use efficiency increased as with reduction in the irrigation.

Singh(2009) conducted studies on drip irrigation resulted in significant increase in production and water use efficiency of potato. At Udaipur it was reported that besides saving in water, the yield of potato tubers was high and weed growth was least in drip irrigation compared to surface irrigation.

## **2.2 Fertigation**

The major advantages of fertigation with drip irrigation are saving of water, labour and time. It also provides uniform distribution of fertilizer and cause least damage to crop and soil. This also offers an opportunity for precise application of water soluble fertilizers and other nutrients to the soil at desired concentrations and appropriate times and all these ultimately provide a higher yield (Kumar, 1992).

The irrigation system should be designed such that it should operate efficiently and should supply nutrient solution at constant rate and pressure from the main flow line. It also should ensure for efficient and uniform distribution of plant nutrients. The fertilizers selected should be completely soluble without leaving any residues. (Gowda, 1996).

The absorption and utilization of nutrients are affected by several factors such as plant species, water availability, media of growth, its pH, solar radiation, temperature and humidity in the green house. Hence for getting sustained productivity of crops under green house, care in proper management of the media and appropriate fertigation programme is essential. Excessive or imbalanced application of nutrients would result in an improper plant growth (Mortvedt, 1997).

Fertigation is one of the recent techniques of applying nutrients to the soil through micro irrigation system. The system permits application of various fertilizer formulations directly at the active root zone. Fertigation system is becoming more popular because of its advantages like, higher fertilizer use efficiency, increased availability of nutrient content to the plant, saving of fertilizer to the range of 20 – 40 per cent, regular supply of crop nutrients at right

proportions and right time, saves labour and energy and facilitates the application of chemicals other than fertilizers for specific purposes (Khan *et al.*, 1999).

The drip irrigation systems require good management and are generally costly. It reduced water application rate and increased the nutrient use efficiencies. Loss of nutrients from the root zone was reduced in the fertigation system (Loccascio, 2000).

Manickasundaram (2005) reported that the fertilizers supplied under traditional methods of irrigation are not effectively used by the crops unlike in fertigation where water and fertilizers are efficiently used by the plant. Studies conducted in various commercial, horticultural and high value crops revealed that adoption of this technology improves the yield and quality of crops. It is also highly beneficial for the farming community in reducing the cost of production. Furthermore sustainability of the soil health is achieved for better productivity and reduced environmental hazards.

### **2.2.1 Advantages of fertigation**

The fertigation allows applying the nutrients precisely and uniformly only to the wetted root zone, where the concentration of active roots is more and this in turn increases the application efficiency of the fertilizer, which results in reduction in the amount of fertilizer applied. This not only reduces the production costs but also lessens the potential of groundwater pollution caused by the leaching of fertilizer. Fertigation allows adapting the amount and concentration of the applied nutrients in order to meet the actual requirement of nutrients of the crop throughout the growing season. The other advantages of fertigation include the following:

- Quick and convenient.
- Eliminates manual application.
- High efficiency and saving of fertilizer up to 20 – 40%.



- Remarkably increases the efficiency of application thereby allowing a reduction in the quantity of fertilizer applied.
- Saving of energy time and labour.
- Fertilizer application may be done for the plants according to their requirement during various growth stages.
- Minimizes the loss of nutrients.
- Nutrients can be applied even if the soil or crop condition does not permit the entry into the field for conventional method of application.
- Major and minor nutrients which are compatible can be applied together in one solution through irrigation.
- Supply of nutrients can be regulated and monitored more carefully.
- Light soils can be brought under cultivation.
- Less fertilizer leaching. (Imas, 1999)

### **2.2.2 Factors to be considered for an effective fertigation**

Effective fertigation requires consideration of many factors like plant growth characteristics which include fertilizer requirements and rooting patterns, fertilizer chemistry including mixing compatibility, precipitation, clogging and corrosion, soil chemistry like mobility and solubility of the nutrients and the water quality factors including pH, salt and sodium hazards and toxic ions.

### **2.2.3 Fertilizer solubility**

The maximum quantity of fertilizer that can be completely dissolved in a given amount of distilled water at a given temperature is called solubility of that fertilizer. The solubility of fertilizer depends on temperature. When the temperature decreases during autumn, the fertilizer solutions stored during the

summer may form precipitates. Therefore it is recommended to dilute solutions stored at the end of summer (Imas, 1999). Table 2.1 shows the solubility of some of the fertilizers at different temperatures.

**Table 2.1 Fertilizer solubility and temperature (g/100g of water)**

Temperature	KCl	K <sub>2</sub> SO <sub>4</sub>	KNO <sub>3</sub>	NH <sub>4</sub> NO <sub>3</sub>	Urea
10°C	31	9	21	158	85
20°C	34	11	31	195	103
30°C	37	13	46	242	133

Source :(Imas, 1999)

## **2.2.4 Interaction of fertilizers and irrigation water**

### **2.2.4.1 Water quality**

When fertilizer interacts with water having high content of calcium, magnesium and bicarbonates, severe problems like formation of precipitates in the fertigation tank and thereby clogging of drippers and filters can occur. In water samples with high contents of calcium bicarbonates, use of sulphate fertilizers can cause precipitation of CaSO<sub>4</sub> interfering drippers and filters. Use of urea causes precipitation of CaCO<sub>3</sub> as urea increases the pH.

The presence of high concentrations of calcium and magnesium in water and high pH values lead to the formation of calcium and magnesium phosphates on reaction with applied phosphorus. These resultant precipitates are deposited on the pipe walls and in orifices of drippers and thus the irrigation system can get completely plugged. At the same time, supply of phosphorus to the root is impaired. Therefore while choosing phosphorus fertilizer for high concentrations

of calcium and magnesium, it is recommended to use acid phosphorus fertilizers like phosphoric acid and MAP (Mono Ammonium Phosphate) (Imas, 1999).

#### **2.2.4.2 Clogging**

In case of clogging of drip system by bicarbonate precipitation, use of fertilizer with acid reaction partially corrects the problem but it may cause corrosion of the metal components of the system and can also damage the cement and asbestos pipes. In order to dissolve the precipitates and thereby prevent clogging, periodic injection of acid is recommended in the fertigation system. Phosphoric, nitric, sulphuric and hydrochloric acids can be used, among which hydrochloric acid is widely used due to its low cost. Acid injection through the system will also remove bacteria algae and slime. The irrigation and injection system should be carefully washed after the injection of acid (Imas, 1999).

#### **2.2.4.3 Fertigation under saline conditions**

Fertilizers are salts and therefore when brackish water is used for irrigation it contributes to the increase of the EC (Electrical Conductivity) of the irrigation water. When irrigation water has EC >2dS/m and crop is sensitive to salinity, the amount of accompanying ions added with N or K should be decreased. For example, to avoid chloride accumulation in the soil solution for a crop very sensitive to chloride,  $KNO_3$  is preferred over KCl. This practice diminishes leaf burning caused by excess of chlorine. Fertilizer with low salt index must be chosen for greenhouse crops grown in containers with a root volume which is restricted. A correct irrigation management under saline conditions includes application of water above the evaporation needs of the crop, so that there is excess water to pass through the root zone and to take away salts with it which is known as leaching. This leaching thus prevents the deposition and storage of excess salt in the root zone and is known as leaching requirement (Imas, 1999).

#### **2.2.4.4 Mixing of fertilizer**

When a fertilizer is dissolved in water, the solubility of the fertilizer should be considered, otherwise a precipitate may form which can clog the irrigation system. Moreover, the nutrients supposed to be provided through the solution may not become fully available. When mixing fertilizer that contains a common element like potassium nitrate with potassium sulphate, the fertilizer solubility of is decreased. In such a case, we cannot consider the fertilizer solubility data shown in Table 1 alone. The solubility of the mixture will have to be found out by trial and error method (Anon., 2008).

#### 2.2.4.5 Fertilizer compatibility

Some fertilizers should not be mixed together in one stock tank because of very quick formation of an insoluble salt. Examples for such incompatibility are:

- Calcium nitrate with any sulphate or phosphates results in formation of precipitates of calcium sulphate and calcium phosphate respectively.
- Ammonium sulphate with potassium chloride or potassium nitrate results in formation of potassium sulphate precipitate.

In order to control precipitates, jar test may be done in which the fertilizers are mixed in exactly in same concentration as intended to be used in the stock tanks in a jar containing the same water used for irrigation. If a precipitate forms or if the solution has a cloudy appearance, the test should be repeated with lower concentrations of the fertilizers (Anon., 2008). Compatibility of some of the commonly used fertilizers is shown in table 2. 2.

**Table 2.2 Fertilizer compatibility chart**

Fertilizer ↙ ↘	Urea	NH <sub>4</sub> NO <sub>3</sub>	(NH <sub>4</sub> ) <sub>2</sub> SO <sub>4</sub>	Ca(NO <sub>3</sub> ) <sub>2</sub>	KCl	K <sub>2</sub> SO <sub>4</sub>	MAP	MgSO <sub>4</sub>	H <sub>3</sub> PO <sub>4</sub>
Urea	C	C	C	C	C	C	C	C	C
NH <sub>4</sub> NO <sub>3</sub>	C	C	C	C	C	C	C	C	C
(NH <sub>4</sub> ) <sub>2</sub> SO <sub>4</sub>	C	C	C	NC	C	LC	C	C	C
Ca(NO <sub>3</sub> ) <sub>2</sub>	C	C	NC	C	C	NC	NC	NC	NC
KCl	C	C	C	C	C	LC	C	C	C

<b>K<sub>2</sub>SO<sub>4</sub></b>	C	C	LC	NC	LC	C	C	LC	C
<b>MAP</b>	C	C	C	NC	C	C	C	NC	C
<b>MgSO<sub>4</sub></b>	C	C	C	NC	C	LC	NC	C	C
<b>H<sub>3</sub>PO<sub>4</sub></b>	C	C	C	NC	C	C	C	C	C

C – Compatible, LC – Limited compatible, NC – Not compatible

Source : (Chandran *et al.*, 2011)

#### 2.2.4.6 Corrosivity of fertilizers

Some fertilizers are corrosive and care should be taken while selecting fertilizers and material used in the making of the system. Table 2.3 shown below illustrates the degree of corrosivity of commonly used metals with some fertilizers

**Table 2.3 Corrosivity of fertilizers**

<b>Kind of metal</b>	<b>Ca(NO<sub>3</sub>)<sub>2</sub></b>	<b>(NH<sub>4</sub>)<sub>2</sub>SO<sub>4</sub></b>	<b>NH<sub>4</sub>NO<sub>3</sub></b>	<b>Urea</b>	<b>H<sub>3</sub>PO<sub>4</sub></b>	<b>DAP</b>
Galvanized iron	2	4	4	1	4	1
Sheet aluminium	No	1	1	No	2	2
Stainless steel	No	No	No	No	1	No
Bronze	1	3	3	No	2	4
Brass	1	2	3	No	2	4

No-none, 1- Slight, 2- moderate, 3-Consierable, 4-Severe

Source: (Anon., 2008)

#### 2.2.4.7 Soil pH

The pH value for optimal availability of all the nutrients is in the range of 6-6.5 (Anon., 2008). The main factor affecting pH in the root zone is NH<sub>4</sub> to NO<sub>3</sub> ratio in the irrigation water, especially in sandy soils and inert substrates with low buffering ability. Rhizospheric pH decides the phosphorus availability since it affects the process of solubilization or precipitation and desorption or adsorption of phosphates. The pH also influences the availability of micronutrients (Fe, Zn and Mn) and the toxicity of some of them.

The nitrogen form absorbed by the plant affects the cation-anion balance and the production of carboxylates in the plant. When NH<sub>4</sub> absorption is predominant, the plant absorbs more cations than anions, H<sup>+</sup> is excreted by the roots and the rhizospheric pH decreases. NH<sub>4</sub> is an undesirable source of nitrogen for some crops (tomato, strawberries) when the temperature in the root zone is

greater than 30°C, as it adversely affect the root growth and plant development as it inhibits the uptake of other cations like  $\text{Ca}^{2+}$ ,  $\text{Mg}^{2+}$  and  $\text{K}^+$ .

The plant absorbs more anions compared to cations, when  $\text{NO}_3^-$  anions are absorbed and the excess of anions is palliated by a greater synthesis of carboxylates which is accompanied by the production and discharge of  $\text{OH}^-$  and dicarboxylic acid through roots in to the soil. The pH of the root zone get increased as the released  $\text{OH}^-$  increases and the organic acid exuded will increase the availability of phosphorus as the carboxylates are adsorbed specifically to iron oxides and clays of the ground, releasing the adsorbed phosphorus to the soil solution (Imas, 1999).

Therefore nutrition with 100% nitrates would increase rhizospheric pH up to unexpected values that would decrease the availability of micronutrients and phosphorus by precipitation. Therefore a nitrogen mixture with 20% of ammonium and 80% of nitrates is recommended to regulate pH.

## **2.3 Methodology of fertigation**

To increase the benefits of fertigation special care should be taken in selecting fertilizers and injection equipment as well as in the management and maintenance of the system.

### **2.3.1 Fertilizer preparation**

#### **2.3.1.1 Stock solution preparation**

Solid fertilizers like ammonium sulphate, urea, potassium chloride and nitrate is mixed with liquid fertilizer like phosphoric acid to prepare a tailor made stock solution. The solution can easily be prepared in situ with minimal mixing with fewer facilities under field conditions. The stock solution is then injected into the irrigation system, at rates of 2-10 l/m<sup>3</sup>, depending on the desired concentrations of N, P and K.

#### **2.3.1.2 Compound solid fertilizer mixture**

It is designed for fertigation between the three major elements N, P and K with different ratios like 20-20-20. Some compositions encompass microelements in the form of chelates.

### **2.3.1.3 Compound liquid fertilizer solutions**

As it is in the solution form, the total concentration of nutrient concentration is very low (5-3-8; 6-6-6). It is specifically used in greenhouses.

## **2.3.2 Dosification**

There are two different types of dosification which may be chosen considering the soil type, the crop grown and the system of farm management.

### **2.3.2.1 Quantitative dosification**

In this type, a predetermined concentration of plant nutrients is applied to the irrigation system. A fertilizer tank is used for fertilizer application in a pulse after a certain sheet of water without fertilizer (Imas, 1999). This type of dosification requires less expense and maintenance but the system is affected by variation in concentration of the fertilizer and the change in water pressure during its application. This method does not support automation.

### **2.3.2.2 Proportional dosification**

In this type, irrigation water takes applied fertilizer in a stable concentration as the nutrients are applied in a proportional and constant ratio to the sheet of water. Fertilizers are directly injected through fertilizer pumps. The merits of this method include injection moment which is not affected by the changes in water pressure and the precise control of the dosification. The automation can be carried out easily but it requires high cost and maintenance (Imas, 1999).

## **2.3.3 Fertilizer injection methods**

Fertigation equipment should be chosen in such a way that quantity of fertilizers applied, proportion of fertilizers, duration of applications and the starting and ending time can be regulated. Therefore it is important to select a fertilizer injection method that suits best for the crop supposed to be grown and the irrigation system adopted. Incorrect selection can result in the damage of the irrigation equipment and it can affect the operational efficiency of the irrigation system and it will also reduce the nutrient efficiency.

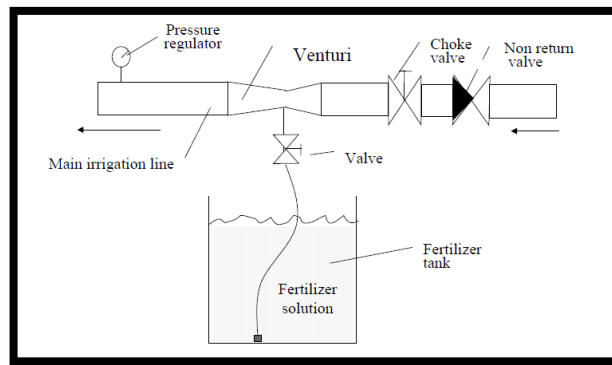
Each fertilizer injector is designed for a particular flow range and pressure. The majority of injectors available today can generally include automatic operation by fitting pulse transmitters that convert injector pulses to electric signals. These signals then control injection of preset quantities or proportions in relation with the flow rate of the irrigation system. Injection rates can also be controlled by flow regulators, ball valves resistant to chemicals or by electronic or hydraulic units for control and computers.

Backflow or siphoning of water and fertilizer solution into fertilizer tanks, irrigation supply and house hold supply may be prevented by installing suitable non return valve or anti siphoning valves. The three methods of injection include:

#### **2.3.3.1 Ventury Injector**

This is a very simple and low cost device. Due to ventury action, a partial vacuum is created in the system, which gives way to the suction of fertilizers into the irrigation system (Anon., 2008). This vacuum is created by diverting a portion of water flow from the main line and passing it through a constriction, which increases the flow velocity, thus creating a pressure drop. When pressure drops, the fertilizer solution is sucked from the tank into the ventury through a suction pipe, from where it enters into the irrigation water as shown in fig. 2.1.





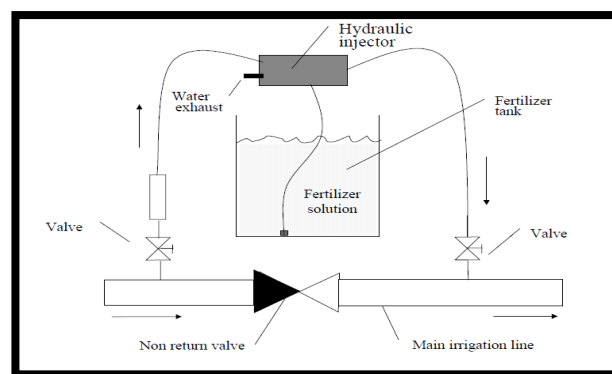
**Fig. 2.1 Ventury injector**

Source: (Imas, 1999)

Jain Irrigation Systems Limited had carried out experiments on the evaluation of performance of ventury injector. The result revealed that motive flow rate and suction rate of ventury injector of  $\frac{3}{4}$  inch for an inlet pressure of  $1 \text{ kg/cm}^2$  and an outlet pressure of  $0.2 \text{ kg/cm}^2$  was correspondingly  $8.4 \text{ l/min}$  and  $70.8 \text{ lph}$  (Anon., 2008).

### 2.3.3.2 Fertilizer pump

The fertilizer pump is a standard component of the control head system. In this system, a non-pressurized tank is used to hold the fertilizer solution and it can be injected into the irrigation water at any desired ratio (Anon., 2008). Therefore, fertilizer availability to each plant can be regulated properly. These are piston or diaphragm pump, which are driven by the water pressure of the irrigation systems such that injection rate and the flow of water is maintained proportionally in the system (Shirgure, 2013). Fig. 2.2 shows the working principle of a fertilizer pump.

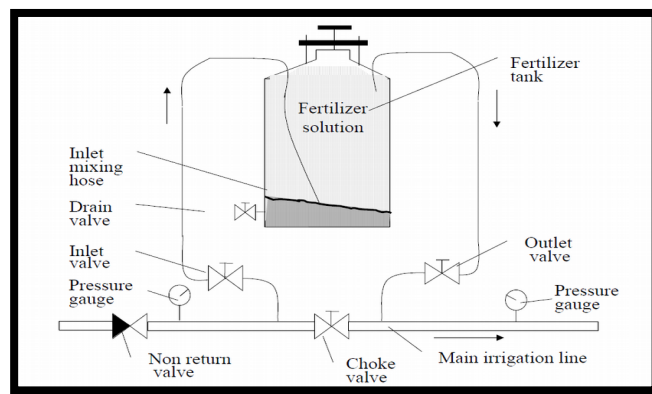


**Fig. 2.2 Fertilizer pump** Source: (Imas, 1999)

Boman *et al.* (2004) concluded that the flow rate of the chemical from the pump depends on the pressure in the irrigation main line. The higher the pressure differences in the irrigation main line, higher the flow rate in the pump.

### 2.3.3.3 Fertilizer tank

As shown in fig. 2.3, in this system, a tank containing the fertilizer solution is connected to the irrigation pipe at the supply point and a part of the irrigation water is diverted from the main line to flow through a tank containing the fertilizer in a fluid or granular form (Anon., 2008). A pressure reducing valve is used to create a slight reduction in pressure between the off take and return pipes of the tank, which causes water from the main line to flow through the tank, resulting in dilution and flow of the diluted fertilizer into the irrigation water.



**Fig. 2.3 Fertilizer tank** Source: (Imas, 1999)

Li *et al.*(2007) reported that a considerably higher coefficient of variation (Cv) was produced by a differential pressure tank for application of water and fertilizer than a proportional pump or a ventury injector for a given emitter type due to release of fertilizer in a decreasing rate by the differential pressure tank.

Comparison of different types of fertigation equipments is given in table 2.4.

**Table 2.4 Comparison of fertigation equipments**

<b>Characteristics</b>	<b>Ventury Injector</b>	<b>Fertilizer tank</b>	<b>Fertilizer pump</b>
Use of granular/solid fertilizer	To be dissolved before application	Possible	To be dissolved before application
Use of liquid fertilizer	Possible	Possible	Possible
Discharge rate	Low	High	High
Concentration control	Medium	None	Good
Head loss	Very high	Low	Low
Ease of operation	Medium	High	Low
Price	Low (Rs. 1500 )	Medium(Rs. 4000)	High (Rs. 12000)

Source: (Chandran *et al.*, 2011)

## **2.4 Monitoring**

### **2.4.1 Plants**

The determination of the nutrient content and dry matter in the whole plant is difficult, destructive and needs laboratory facilities. Therefore plant nutrient status can be monitored in the diagnostic organ, whose concentrations are correlated with the total nutrient content in the plant and is a good indicator of the nutritional state of the crop

### **2.4.2 Soil**

Soil sampling and the determination of the nutrients concentrations in the extracts is a difficult and tiresome method. Instead, the soil solution can be sampled directly in a porous ceramic cups permanently inserted in the soil at a certain depth and the solution is periodically analysed in lab.

### **2.4.3 Field quick test**

This allows a quick determination of pH and content of nitrates, potassium and chlorides present approximately in the soil solution and in the plant sap usually by colorimetric strips.

## **2.5 Fertigation management in greenhouse crops**

Growing plants in containers allows the collection of the leaching water and its comparison with the solution that leaves the drippers and the measurement of pH, EC and nutrients concentration in the leached solution indicates whether the fertilizer are being applied in excess or deficiency, and therefore it allows the simultaneous correction if necessary in the irrigation regime . It is recommended to compare both solutions on a daily basis.

### **2.5.1 Electrical conductivity**

A higher value of electrical conductivity in the leached solution than in the applied solution indicates that the plant takes up more nutrients compared to water and therefore a greater amount of water need to be applied and on the other hand, if the difference between the electrical conductivity values of the leached solution and the incoming solution is more than 0.4-0.5 ds/m, a leaching irrigation should be applied in order to wash the excess of salts (Imas, 1999).

### **2.5.2 Chlorides**

If the chloride concentration in the leachate is higher than the chloride concentration in the incoming solution and if this difference is above 50 mg/l, accumulation of chloride is indicated. Irrigation without fertilizers to leach the chlorides is recommended as remedy in such a case.

### **2.5.3 pH**

The optimal value of pH in the irrigation solution must be close to 6 and that for the leaching solution, it should not exceed 8.5. A more alkaline pH in the leaching water indicates that pH in the root zone reaches a value that can cause precipitation of phosphorus and it decreases the availability of micronutrient.

When pH in the leachate is greater than 8.5,  $\text{NH}_4/\text{NO}_3$  ratio should be adjusted by slightly increasing the  $\text{NH}_4$  proportion (Imas, 1999). When the pH in the irrigation solution is higher than 6, acid must be injected to the solution to lower the pH.

## **2.6 Impact of fertigation on growth and yield of crop**

Haynes (1985) studied the use of fertigation in drip irrigation system. The advantages of fertigation in a drip irrigation system included reduced labour, increased flexibility of fertilizer application and the increased fertilizer efficiency. With the help of fertigation, the nutrient is placed directly into the plant root zone according to the demand at critical periods of plant growth (Mikkelsen, 1989).

A field experiment for comparing fertigation with N, P and K with conventional practise of adding fertilizer in terms of yield, quality and monetary returns was conducted by Bachav (1995). Fertigation at weekly intervals was found more convenient and economically profitable for the farmers.

Hagin and Lowengart (1996) stated that drip irrigation generates a restricted root system requiring frequent supply of nutrients. Nutrient requirement may be satisfied by applying fertilizers in irrigation water. Maximization of crop yield and quality and minimization of leaching losses below the rooting

volume may be achieved by managing fertilizer concentration in measured quantity of irrigation water according to requirement of crop.

Highest fruit yield of 45.7 t/ha was obtained for tomato with application of recommended dose of fertilizers comprising polyfeed (19:19:19), MAP (12:60:0) and urea through fertigation. The yield was nearly 22-27 per cent higher compared to yields obtained with the application fertilizers through soil (Prabhakar and Hebber, 1996).

Srinivas (1999) stated that the application of soluble fertilizer like urea and muriate of potash through drip irrigation could bring about savings of 20-25 per cent in fertilizer use, besides minimizing pollution of ground waters through nitrate – nitrogen leaching to a considerable extent. It also allows the possibilities of using fertilizer matching the crop demand at different stages of growth.

Investigation on the water and nutrient use efficiency of sprouting Broccoli grown in sandy loam soil using fertigation was done by Singh *et al.* (2001). Yields obtained showed that a noticeable saving in the fertilizer applied, to the extent of 20-40 per cent could be accomplished through fertigation.

Kumari and Anitha(2006) did experiment on nutrient management in chilli based cropping system in Kerala. Better growth and yield performance of chilli, French bean and amaranthus was observed when both chilli and intercrops were given 100 per cent nutrient dose. The yield of intercropped chilli was 8917, 5598 and 4865 kg/ha at 100, 75 and 50 per cent nutrient doses respectively

Kumar *et al.* (2007) conducted studies at Agricultural Research Station Bhavanisagar to increase the water and fertilizer use efficiency of drip system in brinjal crop. The experiments were laid out in Factorial Randomised Block Design with nine treatments which included three irrigation levels 100, 75 and 50 per cent of pan evaporation along with three fertigation levels, viz. 125, 100 and 75 per cent of recommended Nitrogen and Potassium application by fertigation and were replicated thrice. In brinjal higher yields with maximum shoot length and number of branches per plant were recorded for the treatment with 75 per cent

of pan evaporation with fertigation of 75 per cent of recommended Nitrogen and Potassium.

Yasser *et al.* (2009) reported the impact of fertigation scheduling on tomato yield under arid conditions. Results revealed that the tomato yields, water and fertilizer use efficiency had been enhanced by 25.6, 49.3 and 20.3 per cent respectively under surface drip in comparison with solid set sprinkler irrigation system. The cost of tomato production under fertigation was comparatively lower to the traditional method of fertilization.

## **2.7 Fertigation automation**

Farina *et al.* (2007) conducted a test on two equivalent groups of raised benches of roses under soilless cultivation with coir dust as substrate. The first group of benches had a Theta ML2x Probe buried in the substrate and was connected with an original controller for fertigation automation. And in the second group, fertigation was carried out by a simple timer for a particular time and duration of irrigation. Quality and flower yield were evaluated for both the groups of benches. A noticeable nutrient saving of 59% and a strong reduction in drained solution volume of 52% with an increase of quality and length of flowers was observed in the case of the Frequency Domain Reflectometer (FDR) probe based fertigation automation.

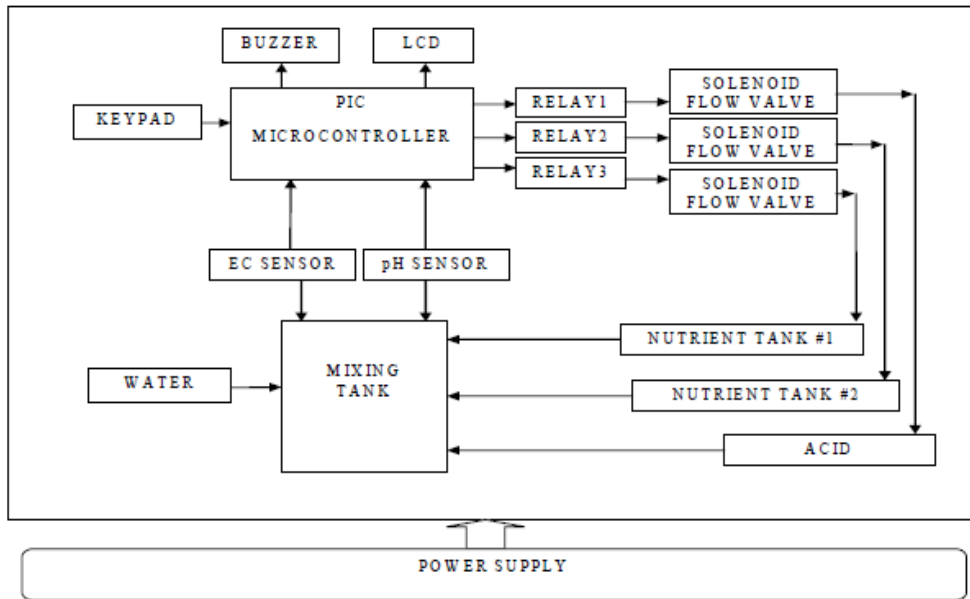
An EU project CLOSYS (CLOsed SYStem for water and nutrient management) system was developed to make a prototype which delivers water and nutrients in accordance with the plant needs through a recirculation system. This prototype aimed at controlling production, quality either by reducing nutrient accumulation or correcting the shortage in the root zone in a closed system. This prototype includes plant and substrate models embedded in an expert system making use of substrate and plant sensors, and a real time controller. The plant model provided correct simulations of parameters of growth and development, concentration of nutrients in the plants and water consumption. The expert system enabled the interface between plant and substrate model. The real time controller

enables the control of relative moisture content and electrical conductivity in the substrate slabs (Brajeul and Maillard, 2006).

Ahmad *et al.* (2011) conducted studies on the speaking plant approach for automatic fertigation system in green house. In order to supply water and nutrition in the right amount and time, plants condition can be observed using a CCD (Charge Coupled Device) camera attached to image processing facilities to develop a speaking plant approach. The plants development amid the growing period were observed using image processing. The response of plant growth in the same conditions were monitored, and the plant response was used as input for the fertigation system to turn on and of the electrical pump automatically, so the fertigation system could maintain the growth of the plants.

Kaur and Kumar (2013) developed a system that comprises of two sensors to measure electrical conductivity and pH of the fertilizer solution and soil. The output signals from the pH and EC sensors are conditioned with signal conditioning cards and then interfaced to microcontroller through inbuilt ADC (Analog to Digital Converter). Microcontroller will then turn ON and OFF particular solenoid valve to spout the fertilizers into the mixing tank based on the pH and EC level in the mixing tank solution. An LCD display is used to the computed results. pH and EC level of fertilizer solution is maintained according to the output readings of EC and pH sensors. Flow chart of automated fertigation using sensors is shown in fig. 2.4.

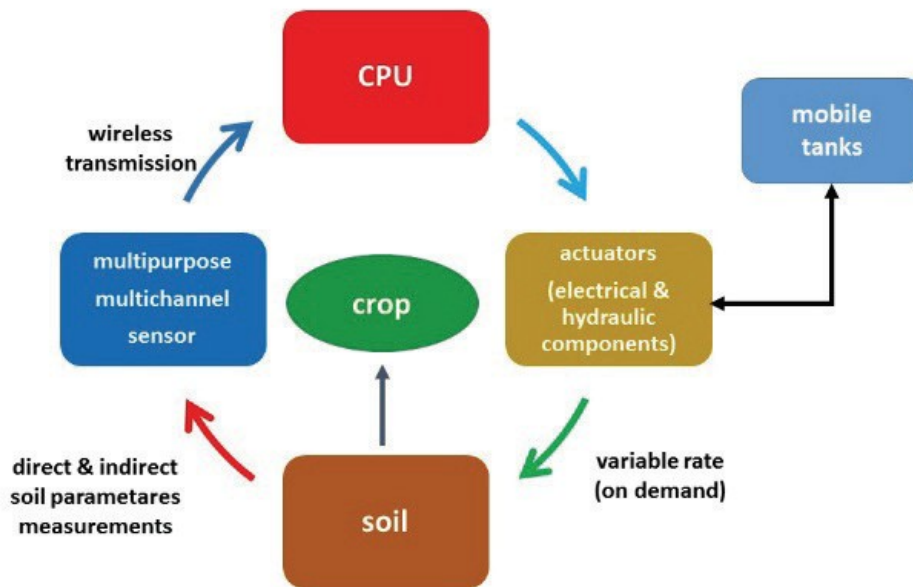




**Fig. 2.4 Fertilization control system**

Source: (Kaur and Kumar, 2013)

Iacomi *et al.* (2014) developed a computer controlled fertigation technique which optimized the water, nutrients and pesticides inputs and protected the natural resources. The system used the correct rates of nutrients and water for plants, thereby not only improving the irrigation system performance but also by reducing inputs costs and increasing crop yield. The main concept behind this research was to save water and to apply fertilisers and pesticides adequately with help of an intelligent and interactive control system for effective fertigation scheduling. The system comprises of a CPU (Central Processing Unit), a data acquisition unit and a driving unit. The embedded software will process the data obtained from soil and plants through sensors and will command to provide appropriate quantities of chemicals to be pumped. It is the driving unit which will act as an interface between the CPU and other elements of the system such as pumps and valves which are actuated according to the commands. The concept of computer based fertigation system is illustrated in fig 2.5.



**Fig. 2.5 The concept of computer-based fertigation system**

Source:Iacomi *et al.* (2014)

Neto *et al.* (2014) developed an automatic system for the real time control and application of fertilizer solution for the production of soilless tomato in sand substrate under greenhouse conditions. The control strategy was according to the transpiration estimates by the Penman–Monteith model and on concentration of leachates by measurements of EC. The performance of the fertigation system was evaluated during tomato cultivation. The yield of the commercial crop was 4.74 kg m<sup>-2</sup> and the average total soluble solids of tomato fruits was 4.50 Brix. The water use efficiency for tomato crop cultivated with the developed system was 17.94 kg m<sup>-3</sup>. 44.42 L of nutrient solution was necessary to produce 1 kg of tomato fruits. The system was efficient in controlling the frequency of fertigation cycles and the prepared fertilizer solution concentration, simultaneously taking care and reducing the environmental problems related to effluent disposal and contributing to thrift of fertilizer and water resources.

Raine and McCarthy (2014) reported about software developed by NCEA (National Centre for Engineering in Agriculture) named 'VARIwise'. It is a software framework that execute and simulates control approaches on fields with variations in all input parameters in sub field scale level. Input parameters are measured using infield soil sensors and real time cameras monitoring crop. The control systems were performed using VARIwise, either by simulation through APSIM model and in field implementations using fertigation actuators. Both the irrigation and fertiliser applications are controlled based on the combination of soil and plant measurements, calibrated crop model outputs and hydraulic modelling.

## **2.8 Solar power utilization for fertigation automation**

Salih *et al.* (2012) developed a fertigation system totally powered by solar energy and its effectiveness was tested in cucumismelo L. cultivation. The system was capable of controlling the process of nutrient mixing and injection of nutrient solutions according to growth rate of plants simultaneously monitoring all the important parameters in fertigation system by using a predefined electrical conductivity value as the single input that control all automated processes. The solar power supply used consists of a 20 watts mono-crystalline photovoltaic solar panel of size 662x299x34 mm, solar charge controller and a battery. During the study, hourly voltage level was measured during cloudy conditions and sunny day. Solar panel produced an average voltage level at 19.3 V during sunny days and 16.4 V during cloudy days. Average power generated by solar panel was around 140 watt hours/day where the system consumes only an average of 10 watt hours/day. The energy left after the consumption was stored inside the battery can hold up to 72 watt hours/day, and thus the system was able to operate up to 7 days without sunshine.

## **CHAPTER III**

### **MATERIALS AND METHODS**

This chapter explains the development and working of the fertigation automation system and its performance evaluation. Field evaluation of the developed automated fertigation system was carried out with salad cucumber crop inside a poly house located in Agricultural Research Station, Anakkayam. A comparative analysis of the biometric observations and yield parameters was conducted between the two groups of crop planted inside the polyhouse, one fertigated automatically with the developed system and the other with manual fertilizer application and also between a third group of plants which was grown in open field with manual fertilizer application.

#### **3.1 Location of the study**

The experiment was conducted inside a polyhouse at Agricultural Research Station, Anakkayam and a plot outside the polyhouse. Geographically the experimental site is located at 11°5'2"N Latitude and 76°7'13"E Longitudes. The site is 25m, above the mean sea level.

#### **3.2 Weather and climate**

The area has humid sub-tropical climate with major rainfall contributed by south west monsoon followed by the north east monsoon. The experimental site lies in humid area. The summers are dry and hot, whereas winter is cool. The experimental site consists of laterite soil with undulating topography. The meteorological parameters like temperature, humidity and intensity of sunlight were measured inside and outside the polyhouse.

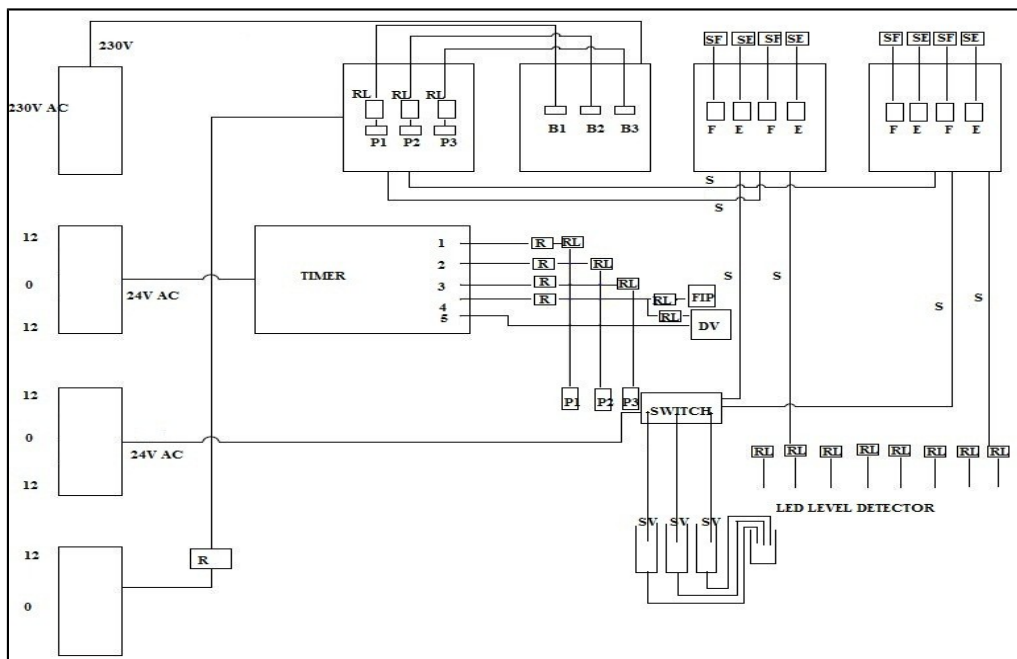
#### **3.3 Period of study**

The study was conducted during the month of August 2015 to March 2016. The system was developed and installed in the polyhouse during the month

of August 2015 to December 2015 and the field evaluation of the system was under taken during the rest of the study period using salad cucumber crop.

### 3.4 Fertigation automation system

Manual fertilizer application is a tedious and labour consuming process. Fertilizer application through drip saves labour. Automatic fertigation allows farmers to deliver adequate nutrient quantity and concentration along with irrigation to plant active root area throughout the growing season automatically thereby saving labour, money and time. An automated system was developed by setting logical circuits between various electrical components during the study. The developed automated fertigation (Fig. 3.1) reduces the chance of over or under fertigation and also saves more labour and it will be accurate in terms of dosage and time.

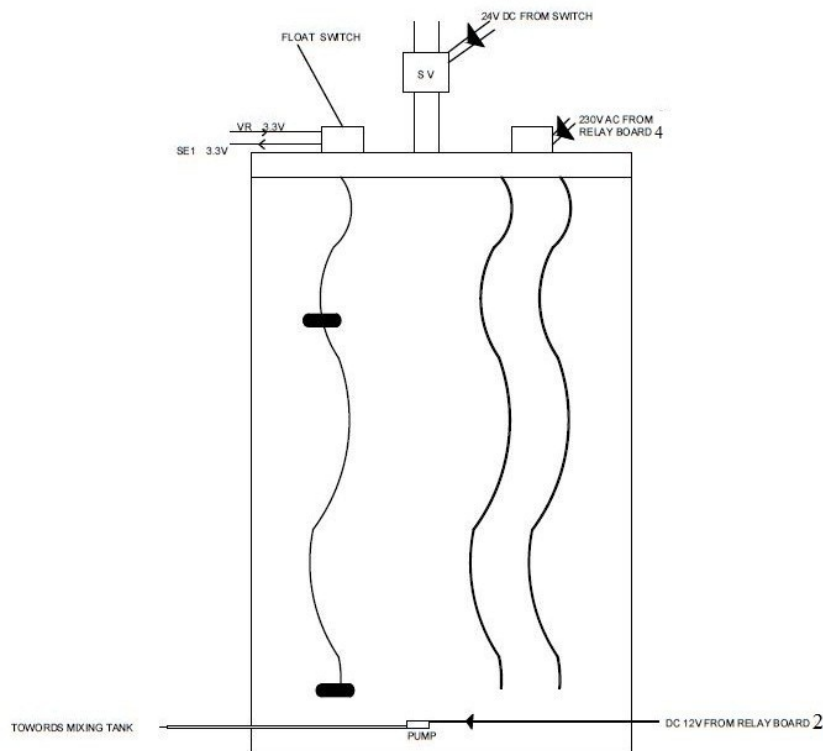


**Fig. 3.1 Logical circuits in the system**

RL - Relay; B1, B2, B3 - Bubbler 1, 2 and 3; F and E – Full and empty; SF and SE – Full and empty signal; R- Rectifiers; FIP- Fertilizer Injection pump; S- Signal; DV- Drip valve; P1, P2 and P3 – Fertilizer pumps

### 3.4.1 Fertilizer tanks

Three fertilizer tanks are used to store concentrated fertilizer solutions individually. Each Fertilizer tank is having 40 l capacity and fertilizers are filled manually to these tanks. Water is filled for making solution through solenoid valves by a push button switch which is in turn controlled by level sensors. Solenoid valves of a particular tank will activate only when the tank is empty and it will deactivate if the tank is full and it will allow filling again only after the tank is empty. Fig. 3.2 shows a fertilizer tank.



**Fig. 3.2 Fertilizer tank**

### 3.4.2 Mixing tank

All the fertilizers which are pumped individually from each fertilizer tanks reach the mixing tank, from where it gets mixed up together thoroughly. The tank is having 10 l capacity. And this mixed solution is then injected into the drip line with the help of an injection pump which is controlled by timer and level sensors.

### 3.4.3 Fertilizer pump

Three fertilizer pumps are used to pump fertilizer from each fertilizer tank to mixing tank. Each pump will work sequentially with the impulse from the timer. The pumps must be calibrated before setting the timer. The pumps work with 12 V DC instead of 24V AC from the timer, so it is connected through a 12V relay. If the tank is empty, the fertilizer pumps will be deactivated even if the timer sends signal to the pump.

### 3.4.4 Fertilizer injector pump

Fertilizer injector pump (FIP) is used to inject fertilizer into the drip line. FIP with an injection rate of 10 l/h is used in this design. It works with 230 V. Table 3.1 shows the specifications of the FIP used in the design.

**Table 3.1 Specifications of FIP**

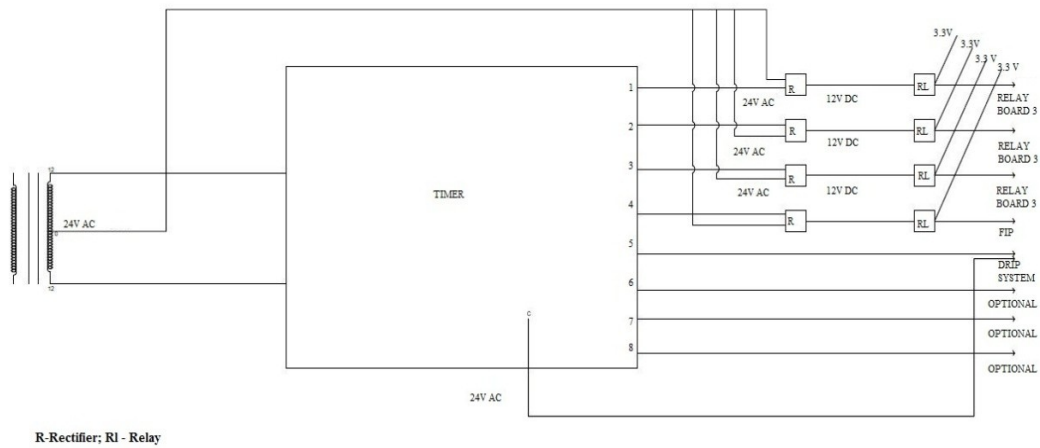
Particulars	Specifications
Electrical	230 V AC, 50 Hz
Suction and delivery tubing	4 mm
Dosing rate	10 LPH at 4 Kg/cm <sup>2</sup>
Strokes/ Minutes	400

### 3.4.5 Level controllers

Level controllers are a set of relays controlled by level sensors / float switch; these controllers control the function of fertilizer pump, bubbler, water filling solenoid valves and fertilizer injector pump.

### 3.4.6 Timer

Timer (Plate 3.4) is the major controlling device in this design and is used to control the working of fertilizer pumps, fertilizer injection pumps and the drip valve according to the preset timings. Timer (Fig.3.3) works with 24 V AC, which can control any device that works with 24 V AC like solenoid valves. It has 2 input slots, 1 common slot and 8 control slots.



**Fig. 3.3 Connection diagram of a timer**

1. Slot 1 or timer station T1 used to control fertilizer pump1 and bubbler 1
2. Slot 2 or timer station T2 used to control fertilizer pump 2 and bubbler 2
3. Slot 3 or timer station T3 used to control fertilizer pump 3 and bubbler 3
4. Slot 4 or timer station T4 used to control fertilizer injector pump
5. Slot 5 or timer station T5 used to control drip
6. Slot 6-8 or timer station T6-T8 are optional control slots for installing additional instruments like mist, side curtain.

### 3.4.7 Auxiliary components

The auxiliary components used for the automation system include the following

1. Transformers
2. Single relay board
3. 4 - channel relay board



4. Voltage regulator
5. 12V 7A Relays
6. Push button switches
7. Rectifiers
8. 2" Solenoid valve
9. 1" Solenoid valves
10. Float switches
11. Bubblers
12. Level indicators
13. Solar panels
14. Battery -150 AH, 12 V
15. Solar power generator

#### **3.4.7.1 Transformers**

A transformer is an electrical device that transfers electrical energy between two or more circuits through electromagnetic induction.

##### **12-0 V, 2A transformer**

This transformer is used to supply power to the fertilizer pumps.

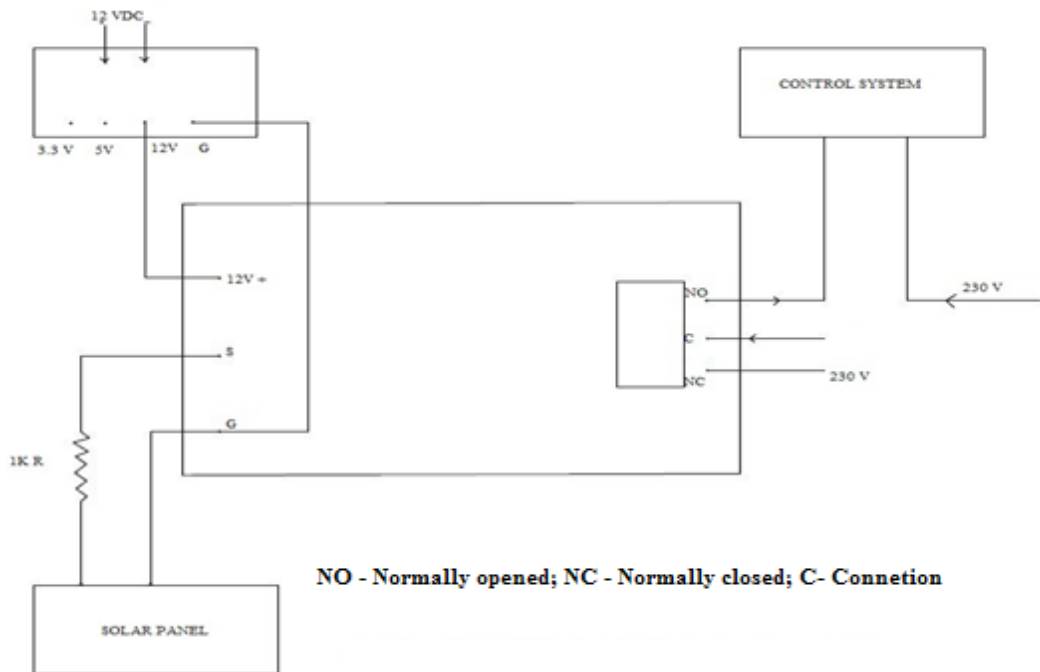
##### **12-0-12 V, 3A transformer**

Two transformers of this specification were used. One of them was used to supply power to the 8-station timer while the other supplied power to the relay boards and solenoid valves.

#### **3.4.7.2 Single relay board**

A relay is an electrically operated switch. Current flowing through the coil inside the relay creates a magnetic field which in turn will attract a lever and changes the contact between the switches. The relays have two switch positions as coil current can either be in on or off condition. The relay's switch connections are usually named C, NC and NO, where C stands for connection, NC for Normally Closed and NO for Normally Open. Either NC or NO is always connected to this C pole. C pole is connected to NC when the relay coil is not magnetized. C pole is connected to NO when the relay coil is magnetized and vice versa.

Single relay boards are used in the design to switch 'ON' and 'OFF' the control system. This single relay board works in 12V and senses voltage within a range of 3.3V to 5V. The system will automatically shut down after sunset and will get started again during daytime. This is done by connecting the relay board to a 12 V solar panel for power supply to the board and also as signal to the board through a resistance. Fig. 3.4 shows the connection diagram of single relay board.



**Fig. 3.4 Connection diagram of a single relay board**

### 3.4.7.3 Relay board (4 – channel)

Four 4-Channel relay boards are used for controlling pumps, bubblers and level sensors inside the tanks and FIP. These 4-channel relay boards works in 12 V and senses voltage within a range of 3.3 V to 5 V. Fig. 3.5 shows the connection diagram of 4- channel relay board.

#### **3.4.7.4 Voltage regulator**

Voltage regulator regulates the power supply from 12 V DC to 3.3 V DC, 5 V DC and 12 V DC.

#### **3.4.7.5 Relay (12V 7A)**

Four 12V 7A relays are used for controlling four 4-Channel relay boards that control pumps and bubbler. Other than this, eight relays of same specification are used for the working of fertilizer level indicators.

#### **3.4.7.6 Push button switch**

Push button switches are used for activating the solenoid valves for filling of fertilizer tanks with water. These are three in number.

#### **3.4.7.7 Rectifiers**

Rectifiers are used to convert AC to DC.

#### **3.4.7.8 Solenoid valves**

A solenoid valve is a valve which helps to operate a valve automatically. Solenoids use an electromagnetic solenoid coil to change the state of a valve from open to closed, or vice-versa. If the solenoid valve is in normally closed condition, when the coil is energized, the valve gets lifted open by the electromagnetic force produced by the coil. It requires pressurised water.

#### **2” Solenoid valve**

2” Solenoid valves are used to switch ON and OFF drip.

### **1” Solenoid valve**

1” Solenoid valve is used to fill water in the fertilizer tanks.

#### **3.4.7.9 Float switch**

Float switches are used inside each tank to sense whether the tank is empty or full and send the signal to level indicator, fertilizer pump controlling relay, bubbler relay and push button switch. When the tank is full, the level indicator shows green signal, it cuts the power supply to the respective tank filling pushbutton switch and the power supply switch will be engaged only after tank is emptied. When the tank is empty, the power is supplied to the relay board connected to the red light in the level indicator. Table 3.2 shows the specifications of the float switch. Fig. 3.6 shows float switch.

**Table 3.2 Specifications of float switch**

Particulars	Specification
Operating Voltage (AC)	110 V/240 V
Connecting load	15 amp
Resistive load	15 amp
Direct load	1 HP
Measurement Method (Electrical)	External Type

#### **3.4.7.10 Bubblers**

Bubblers are used to agitate the fertilizer inside each tank with water to make thorough fertilizer solution before every pumping into the mixing tank and it is controlled by the timer through bubbler relay. The bubbler is working with 230 V AC instead of 24 V AC from the timer so it is also connected through a 12 V relay.

#### **3.4.7.11 Level indicators**

Level indicators (Plate 3.5) are used to indicate the fertilizer level in each tank. It indicates whether the tank is empty or full. These are eight in number, 2 each for three fertilizer tanks and one mixing tank.

#### **3.4.7.12 Solar panel**

Solar panel (Plate 3.1) with specification of 16 V 250 W was used in the design to get an uninterrupted power supply to all the control units particularly the timer.



**Plate 3.1 Solar panel**

#### **3.4.7.13 Battery**

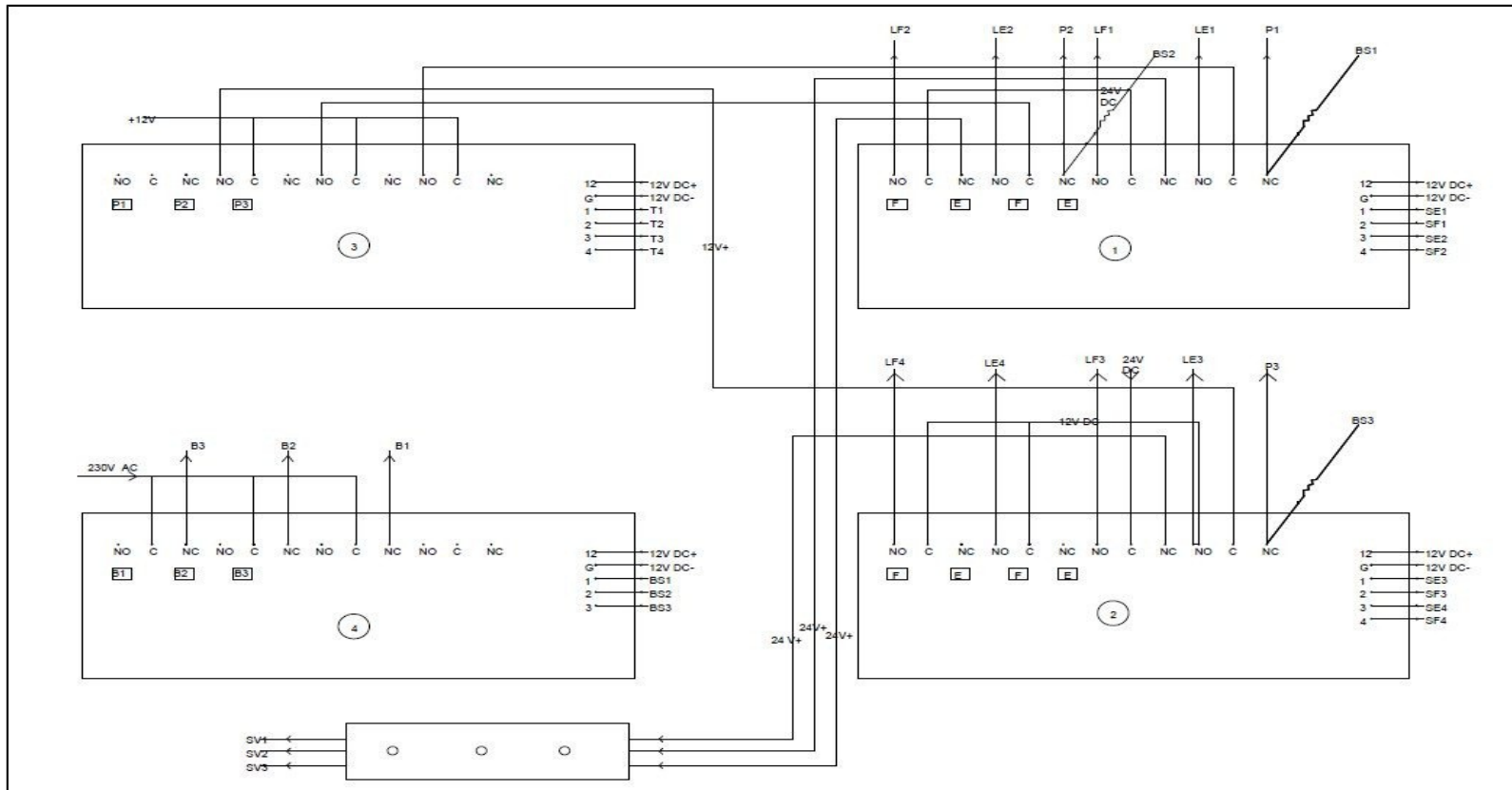
A 150 AH 12 V battery is used for storing the solar power.

#### **3.4.7.14 Solar power generator**

Solar power generator is used to convert the solar power to 230 V, 550 W.

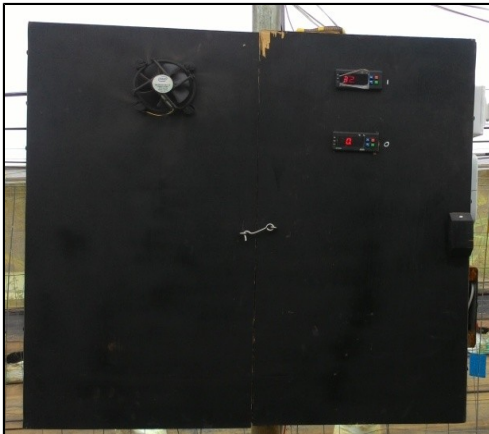
#### **3.4.7.15 Wooden casing**

Other than fertilizer and mixing tanks, timer and level indicators all other components of the logical control circuit (Plate 3.3) which control the working of the system is enclosed in a wooden casing of size 70x70x28 cm fitted with an exhaust fan to reduce the heat inside the casing (Plate 3.2).

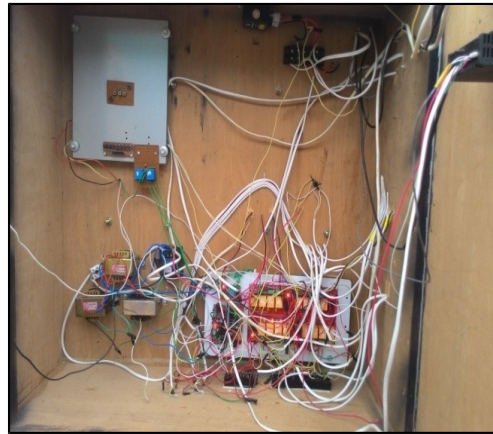


**Fig. 3.5 Connection diagram of a 4 - channel relay board**

**T1 to T4 – Timer stations; LE and LF- Empty and full level indicators; NO, C, NC- Normally opened, connection, normally closed; B1,B2,B3Bubbler 1,2 and 3; E and F- Empty an full; SE an SF – Signal empty and signal full; BS1,BS2,BS3-Bubbler signal; SV-Solenoid valves**



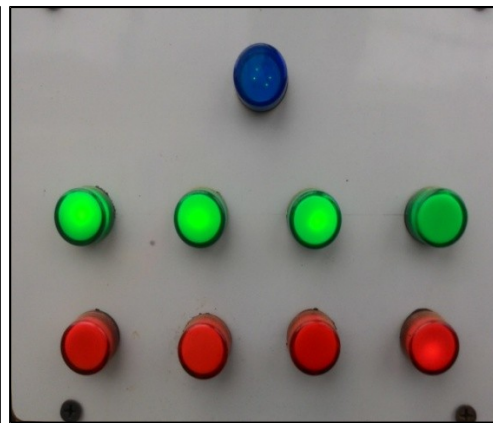
**Plate 3.2 Wooden casing**



**Plate 3.3 Control circuit**



**Plate 3.4 Timer**



**Plate 3.5 Level indicators**



**Fig. 3.6 Float switch**

### **3.5 Drip irrigation unit**

**Water source:** Pressurised water source (Tank located 10 m above ground level)

**Main pipe:** PVC pipe of pressure rating 6 kg/cm<sup>2</sup> with 63 mm diameter was used to convey water from source to the experimental site through sub mains.

**Sub main:** PVC pipe of pressure rating 6 kg/cm<sup>2</sup> with 50 mm diameter was used as sub main pipe to convey water from main lines to laterals.

**Lateral pipe:** LDPE pipe of 16 mm was used as laterals.

**Micro tube:** LDPE pipe of 6 mm was used as micro tube.

**Emitters:** Emitters used were arrow drippers of 8 lph capacity.

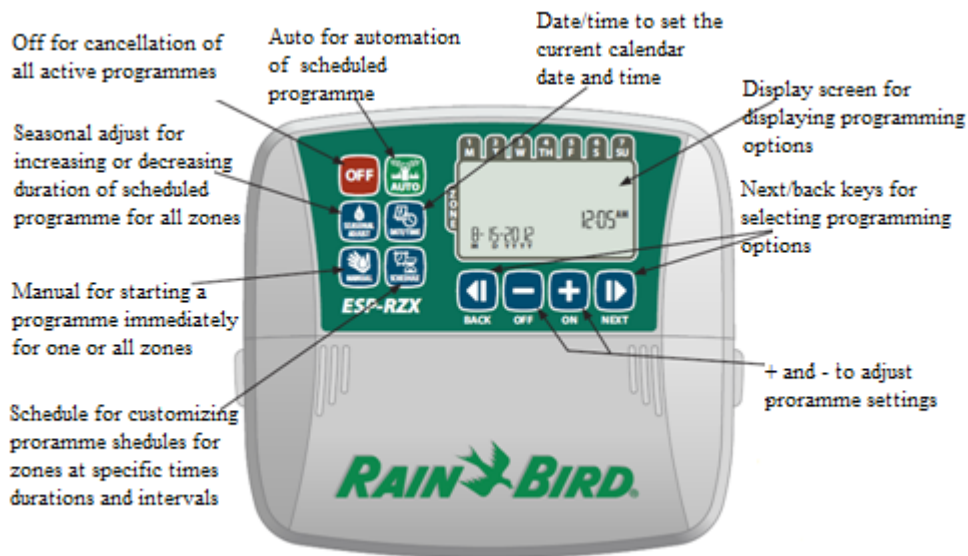
### **3.6 Operation of fertigation automation system**

The most important part of this automated fertigation system is the timer which controls the whole system. The signal from the timer at pre-set timings activates the various major and auxiliary components in the system.

#### **3.6.1 Key functions of a timer**

The key functions of different modules of a timer are shown in fig. 3.7. The setting up of these modules is explained below.





**Fig 3.7 Key functions of a timer**

### 3.6.1.1 Auto

Auto option is used for watering and fertigation automatically according to programmed irrigation and fertigation schedules.

#### 3.6.1.1.1 In auto mode

The display shows the current time, date and day of the week.

#### 3.6.1.1.2 During fertigation and irrigation

The display shows a blinking sprinkler symbol, the active zone number and watering run time remaining for that zone. + or- option is to adjust fertigation and watering run time remaining for the active zone as desired and NEXT option to immediately cancel watering for the active zone and advance to the next zone in the irrigation queue.

#### 3.6.1.2 Off

Off option is used for cancelling all active watering immediately and disable fertigation and irrigation. Programmed fertigation and irrigation schedules remain stored in memory even when the controller is turned off or if power is lost.

### **3.6.1.3 Date/Time**

Date/Time option is for setting the current calendar date and time of day.

### **3.6.1.4 Schedule**

Schedule option is for creating customized fertigation and irrigation schedules to run automatically at specific times, durations and intervals.

#### **3.6.1.4.1 Selection of zone**

Zones are designated areas that are defined as locations for operation. These are the components which are directly connected to the different slots of the timer which are activated at preset timings. Or by selection of zone, it means selection of timer station for the operation. Zone of operation or the components connected to each slots of the timer is already being mentioned. + or – options may be used for selecting the desired zone number and then NEXT option may be opted.

#### **3.6.1.4.2 Setting operation run times**

Run times are durations set for operation. Run Times can be set between 1 to 199 minutes. + or – options may be used for increasing or decreasing the operation run times. Fig. 3.8 shows the display of setting run times

#### **3.6.1.4.3 Setting operation start times**

Operation start times are times of day at which a particular operation is set to begin. A total of up to six Start Times (1-6) are available for each Zone. Fig 3.9 shows, how to set the start time of an operation. + or– options should be used to set the 1st Start Time and then press NEXT. This may be repeated to set additional Start Times for that Zone as desired.

#### **3.6.1.4.4 Set operation start days**

Watering start days are the calendar days or intervals on which watering is allowed.+ or– options may be pressed to select one of four available operation start day options:

- a. Custom Days - To schedule an operation to occur on selected days of the week.
- b. Odd Days - To schedule an operation to occur on all odd calendar days.
- c. Even Days - To schedule an operation to occur on all even calendar days.
- d. Cyclic Days - To schedule an operation to occur at intervals.

#### **3.6.1.5 Manual**

Manual option is used for starting an operation immediately for all zones or for any one zone. For operation all zones, manual key is pressed and all zones appear as the default selection and for operating one zone, + or – may be pressed to select any one station and press NEXT to continue. + or– should be pressed to set the desired run time, then press NEXT to begin watering.

### **3.7 Working of the system**

In this design, timer station T1 becomes ON according to the pre-set timings and if tank1 is not empty, fertilizer pump P1 and bubbler B1 get activated through two 12 V relays respectively. If the tank is empty T1 goes to OFF condition or else, P1 and B1 get activated. Sequentially when timer station T2 becomes ON according to the pre-set timings, it is checked whether the tank is empty. If it is empty T2 goes to OFF condition or else fertilizer pump P2 and bubbler B2 get activated through relays. Similarly, when T3 is ON according to pre-set timings, P3 and B3 get activated through relay when tank is not empty and if it is empty, it turns OFF. When timer station T4 becomes ON according to pre-set timings, level in the mixing tank is checked, and if it is empty, it turns OFF. But if the tank is not empty, fertilizer injection pump along with drip valve get activated through relays. When timer station T5 becomes ON according to pre-set

timings, drip valve turns ON. The conditions whether the tanks are empty or not empty are decided by the level sensors / float switch (which will be indicated by level indicators).

### **3.8 Calibration of fertilizer pumps**

In laboratory, three fertilizer pumps were calibrated to find out how much amount of water it pumps out in a minute for which the pump was placed in a container with water and was allowed to pump to a height equal to the height of mixing tank for 1 minute and the amount of water coming out through pump outlet was collected and measured using a measuring cylinder,. This was done three times and the average value was noted. Calibration was done to decide how much time the pump should work so as to apply required amount of fertilizer for the plants. And this time is then set in the timer station T1, T2 and T3 for the working of fertilizer pumps. Process of calibration was done two times during the crop season as the pumping rate may vary with time due to fertilizer deposition.

The fertilizer recommendation for the crop for an area of 1 ha was obtained from Package of Practise (POP) (KAU, 2011) from which the fertilizer requirement for the existing number of plants in the field was calculated considering the recommended spacing. The total fertilizer required for the crop was provided in uneven splits in such a way that, fertigation was carried out once in three days and a break was provided in this schedule after four dozes of fertilizer application to avoid the salt injury to the crop due to fertigation. The total amount of water required for each fertilizer to achieve the desired concentration was also calculated. The total amount of fertilizer and water as per the calculations is initially filled in the tank (float switches are adjusted inside the tanks according to the amount of water initially present in each tank) and is pumped according to the schedule. The schedule was prepared for 90 days interval.

### **3.10 Duration of operations**

As the amount of fertilizer added during different splits and the requirement of different fertilizer differed, the time of pumping of each pump for achieving the required amount of fertilizer was calculated considering the amount of fertilizer pumped in unit time by each pump. This time of pumping thus calculated is being set in the timer stations T1, T2 and T3. As the crop growth progresses the nutrient requirement of the crop differs so the timer has to be reset accordingly. Timings of the stations T4 which controlled the fertilizer injection pump and T5 which controlled the drip valve were set to work for duration of ten minutes throughout the crop season.

The crop was irrigated four times daily at timing 8.30 AM, 11.30 AM, 2.30 PM and 5 .00 PM for duration of ten minutes each. These timings were set in the timer for timer station T5 which controlled the drip valve. When timer station T4 becomes ON once in three days according to the preset timings and if the tank is not empty, the fertilizer injection pump along with drip valve gets activated through relays at the irrigation timings 11:30 AM and 5 PM for a duration of 5 minutes each. Thus all the other days only the drip valve were activated through the timer.

### **3.11 Experimental setup**

#### **3.11.1 Polyhouse**

Poly houses are basically naturally ventilated climate control structures mainly used for applications like growing vegetables, floriculture, planting material acclimatization etc. Polyhouse used for this experiment was made using GI class B pipe poles (Plate 3.6). The roofing is provided with a transparent UV (Ultra Violet) stabilized low density polyethylene sheet of 200 micron thickness, which creates a micro climate inside the polyhouse by regulating relative humidity and temperature, as it partially cuts the UV rays. The specifications of the polyhouse used for the study are as given in Table 3.3.

### 3.11.2 Crop and variety

Salad Cucumber (*Cucumis sativus*) variety Saniya was used for the experiment. It is a high yielding variety which grows vigorously and mostly bears female flowers. The fruit skin is glossy green with few spines and it tastes crispy and sweet, making it suitable for salad or frying and the crop is most suited for polyhouse cultivation. Seeds were sown in a pro tray containing mixture of vermi compost and coir pith in 1:1 ratio to a depth of 0.5 cm on 7/12/2015. These seedlings were transplanted into grow bags on the seventh day on 14/12/2016. Plate 3.9 shows the seedlings in the pro tray before transplanting in the plot

**Table 3.3 Specification of polyhouse**

Particulars	Specifications
Centre height	6.5 m
Side height	4m
Area inside	291.9 m <sup>2</sup>
GI pipes	Class B of 2 inch diameter
Roofing	200 micron thickness UV stabilized LDPE
Side net	40 mesh nylon insect proof net



**Plate 3.6 Polyhouse**

### 3.11.3 Experimental procedure

Evaluation of the automated fertigation system was carried out by installing the system in a polyhouse of 291.9 m<sup>2</sup>. Total 186 plants were planted in the polyhouse and were automatically fertigated; another 24 plants were planted in the same poly house which was fertilized manually. In open field another 24 plants were grown and fertilized manually and the biometric and yield parameters of randomly selected plants 4 and 7 in number respectively from each plot were noted and was compared with each other to evaluate the efficiency of the system using statistical analysis.

#### **3.11.4 Layout of the experiment**

First set of plants with automated fertigation system were grown inside the polyhouse in seven rows at spacing of 2 x 1.5 m with 24 plants in one row and 27 plants in the other six rows adding to a total number of 186 plants. The next set of plants in which fertilizer was applied manually was grown in the same polyhouse with 24 plants planted in a single row. The third set of plants was grown in open field in 4 rows with 6 plants in each row adding to a total of 24 plants. All the plants were grown in grow bags of size 24x24x40cm with potting mixture which contained soil, coir pith and dried farm yard manure (FYM) in the ratio 2:1:1. Drip irrigation system with an emitter spacing of 1.5m was installed in all the plots with arrow drips of 8 lph capacity. Plate 3.7 and plate 3.8 shows the layout of field experiment inside the polyhouse and open field respectively.



**Plate 3.7 Layout inside polyhouse**

**Plate 3.8 Layout in open field**



**Plate 3.9 Seedlings in the protray before transplanting**

### **3.12 Fertigation**

The fertigation system was installed inside the polyhouse. The required amount of different fertilizers for the plant is filled in separate fertilizer tanks and the tank is filled with desired quantity of water with the help of push button switch. Fertilizers used were ammonium nitrate ( $\text{NH}_4\text{NO}_3$ ), mono-ammonium phosphate ( $\text{NH}_4\text{H}_2\text{PO}_4$ ) and potassium sulphate ( $\text{K}_2\text{SO}_4$ ). Inside each tank, these fertilizer solutions are mixed thoroughly with the help of a bubbler. After mixing, the solutions are pumped to the mixing tank sequentially according to the preset timings from where it is pumped to the drip system through FIP. Other nutrient fertilizers such as calcium nitrate ( $\text{Ca}(\text{NO}_3)_2$ ) which were essential for the plant growth were directly fed into the mixing tank in the form of solutions whenever necessary. The arrangement of fertilizer tank and mixing tank is shown in the Plate 3.10.





**Plate 3.10 Fertilizer tank along with mixing tank and FIP arrangement**

### **3.13 Pest and disease control**

Well-grown and productive crops are generally less susceptible to diseases, but in some cases conditions for disease and pest prevention will be required. Well-fertilized and irrigated crops are however, often more sensitive to pests like aphids, whiteflies and leaf miners. Daily observation and management during the growth periods are essential to minimize economic loss.

Blue and yellow charts coated with castor oil were hung in all the three plots to control the growth of leaf miners and whiteflies respectively. This was done immediately when signs of these pests were observed early in the fruiting period. Occasional cleaning of these charts was done followed by the application of castor oil. Fish amino acid was sprayed in all the three plots at a concentration of 2 ml/L to prevent whiteflies during fruiting period. Then manual weeding was effectively done daily during the crop growth period.

### **3.14 Field data collection**

#### **3.14.1 Biometric observations**

Biometric analysis on growth of the plant was done. The main crop growth parameters like height of the plant, days to initial budding, days to first flowering, days to 50 percentage flowering, days to first harvest, Leaf Area Index (LAI) were

observed. The crop was transplanted on 14/12/2015. Biometric observations of 4 randomly selected plants were taken from each plot.

#### **3.14.1.1 Height of the Plant**

Height of the plant was measured from ground level to tip of top most leaf. Readings were recorded for each selected plants from three different treatment plots from the transplanted date at an interval of 18 days.

#### **3.14.1.2 Number of days to initial budding**

The time taken by the crop to start initial budding stage from date of transplanting was observed. The number of days for each treatment was recorded.

#### **3.14.1.3 Number of days to first flowering**

The time taken by the crops from initial budding to start initial flowering stage from date of transplanting was observed. The number of days was recorded for each treatment.

#### **3.14.1.4 Number of days to 50% flowering**

. The time by which, 50% of the plants got its flowers from date of transplanting was observed. The number of days for each treatment was recorded.

#### **3.14.1.5 Number of days to first bearing**

The time by which first fruit was seen from date of transplanting was observed. The number of days for each treatment was recorded

#### **3.14.1.6 Number of days to first harvest**

The number of days taken by the crops to reach final fruiting stage for the first harvest was recorded for each treatment.



**Plate 3.11 Cucumber plants**

**Plate 3.12 Harvested fruits**

### **3.14.1.7 Leaf area index**

The average length and width of five leaves of the selected plants were taken from the date of transplanting at an interval of 18 days and the mean leaf area (LAM) and in turn the leaf area index (LAI) was found out by the method of estimation suggested by Blanco and Folegatti (2003).

$$LA = 0.859 * (L * W) + 2.7 \quad \dots (3.1)$$

$$LAI = (LAM * N) / A \quad \dots (3.2)$$

Where, L, W are the average of length and width of the leaves of the selected plant, N the number of leaves in that plant and A the area occupied by the plant.

### **3.14.2 Yield parameters**

Yield parameters like size of the fruit, number of fruits harvested per plant and yield of seven plants were recorded during the study.

#### **3.14.2.1 Number of fruits/plant**

Seven plants were selected randomly from each plot. The total number of fruits per plant was recorded at each harvest and the added total number at the end of the crop was calculated as the yield of randomly selected plants.

#### **3.14.2.2 Size of the fruit**

Seven plants were selected randomly from each plot. The length and equatorial circumference of each fruit obtained was measured and average for each plant was calculated.

#### **3.14.2.3 Yield (t/ha)**

Harvesting of the crop was done in each plot after attaining maturity. Weight of harvested fruits was taken and the yield was worked out in t/ha.

**STAGES OF PLANT GROWTH**



**Plate 3.13 Sowing**



**Plate 3.14 Germination**



**Plate 3.15 Transplanting**



**Plate 3.16 Budding**



**Plate 3.17 Flowering**



**Plate 3.18 Fruiting**

### 3.15 Statistical analysis

The data collected was subjected to statistical scrutiny viz., ANOVA (Analysis of Variance) and Student-t test as per methods suggested by Gomez and Gomez (1984) and executed using the software SYSTAT and MS Excel. CRD design was used for the analysis. Wherever the results were significant, critical differences were worked out at probability level  $p < 0.05$ . The non-significant differences were denoted as NS. With respect to Student t test, if the calculated value exceeds the table value, then the treatment is significantly different at that level of probability based on the hypothesis tested. In the present study it was considered a significant difference at  $p = 0.05$ , and this means that if the null hypothesis were correct (i.e. the treatments do not differ) then “*t*” value has to be greater as this, on less than 5% of occasions. This means that, the treatments do differ from one another, but we still have nearly a 5% chance of being wrong in reaching this conclusion.

## **CHAPTER IV**

### **RESULTS AND DISCUSSION**

The study was conducted during the period from August 2015 to March 2016 at Agricultural Research Station, Anakkayam. The system was developed during the months of August 2015 to November 2015. Field evaluation of the developed automated fertigation system was carried out with salad cucumber crop inside a poly house during the months of December 2015 to March 2016 and a comparative analysis was done between the biometric observations and yield parameters of the two groups of crop planted inside the polyhouse viz. fertigated automatically with the developed system and with manual fertilizer application and the crop grown outside the polyhouse with manual fertilizer application. The results of the study are presented in this chapter.

#### **4.1 Weather and climate**

The meteorological parameters such as temperature, humidity and intensity of sunlight were measured throughout the study. Average temperature of 35 °C was maintained inside the poly house, whereas a temperature range of 38°C to 42 °C was observed in the open field. This cooling effect was obtained inside the poly house with the help of the fans and fog evaporative cooling system installed inside the polyhouse. Inside the polyhouse a higher humidity of 50% and 95% were observed during day and night times respectively, whereas in open field it was 40% and 90% respectively. This higher humidity range inside the polyhouse was achieved using evaporative cooling system. UV protection sheet used for the roofing reduced the sunlight intensity to an average value of 20000 lux, whereas in the open field it was in the range of 70000 lux.

#### **4.2 Laboratory evaluation of the system**

The components of the developed system were evaluated in the laboratory to ensure its proper working in the field and the fertilizer pumps were calibrated.

#### 4.2.1 Calibration of fertilizer pumps

The calibration of the pump was done at the beginning and midst of the crop season and similar values were obtained in both cases. Hence, no change was required in the setting time which was scheduled as per the first calibration which showed there was no sign of fertilizer deposition. The average pumping rate per minute for three fertilizer pumps are shown in table 4.1.

**Table 4.1 Average pumping rate of fertilizer pumps**

Date	Pump 1 (l/min)	Pump 2 (l/min)	Pump 3 (l/min)
13-12-2015	1.3	0.7	1.7
08-02-2016	1.3	0.7	1.7

#### 4.3 Fertigation scheduling

According to POP recommendations, cucumber plant requires 104 kg ammonium nitrate, 40 kg mono ammonium phosphate and 55 kg potassium sulphate for an area of 1 ha. From this, the fertilizer requirement in each plot was estimated considering the spacing and the number of plants in each plot. Thus after calculations it was found that 0.031 kg ammonium nitrate, 0.012 kg mono ammonium phosphate and 0.016 kg potassium sulphate fertilizer was required for each plant. Finally the total amount of fertilizer required for each plot was calculated as given in table 4.2

**Table 4.2 Total amount of fertilizer required in each plot**

Plots	Number of plants	NH <sub>4</sub> NO <sub>3</sub> (kg)	NH <sub>4</sub> H <sub>2</sub> PO <sub>4</sub> (kg)	K <sub>2</sub> SO <sub>4</sub> (kg)
T <sub>1</sub>	186	6	2.5	3
T <sub>2</sub>	24	0.744	0.288	0.384
T <sub>3</sub>	24	0.744	0.288	0.384

The total amount of fertilizer required in the plot which is to be automatically fertigated was scheduled in 24 split dozes, in such a way that doze will be given once in three days. A break was given after every four dozes i.e., the



fertilizer was not added along with the drip after 4 dozes of application so as to prevent clogging and to wash away all the fertilizer that may get deposited in the system. By considering the rate of pumping of each fertilizer pump, the duration for which each fertilizer pump should operate to achieve the required amount of fertilizer application was calculated for all the split dozes. This calculated timing was set in the timer. The total quantity of water required during the crop season was also calculated (Table 4.3) and each fertilizer tank was filled with required amount of corresponding fertilizer and water in the beginning itself. The fertilizer schedule and the pump timing are shown in Appendix I.

**Table 4.3 Total amount of water to be filled initially in each fertilizer tank**

<b>Fertilizer tanks</b>	<b>NH<sub>4</sub>NO<sub>3</sub></b>	<b>NH<sub>4</sub>H<sub>2</sub>PO<sub>4</sub></b>	<b>K<sub>2</sub>SO<sub>4</sub></b>
<b>Total water (l)</b>	36.4	39.2	40.8

#### **4.4 Solar panel performance**

The solar panel could produce a voltage level of 16 V and 13.6 V during sunny and cloudy days respectively. Average power generated by solar panel was around 250. Energy consumption for the system on an average was only 33.72 W-h. The battery can hold up to 1800 watt, hence the system can operate up to 53 hours equivalent to 4.4 days (as the system works only during day time) without sunshine. Table 4.4 shows the wattage consumption by various components in the system.

**Table 4.4 Energy consumption rate of various components**

<b>Sl. No</b>	<b>Component</b>	<b>Total energy consumption (W-h)</b>
1	Timer	3.12
2	Transformers	14.4
3	Pumps	1.2
4	FIP	15

#### **4.5 Biometric observations**

#### 4.5.1 Height of the plants

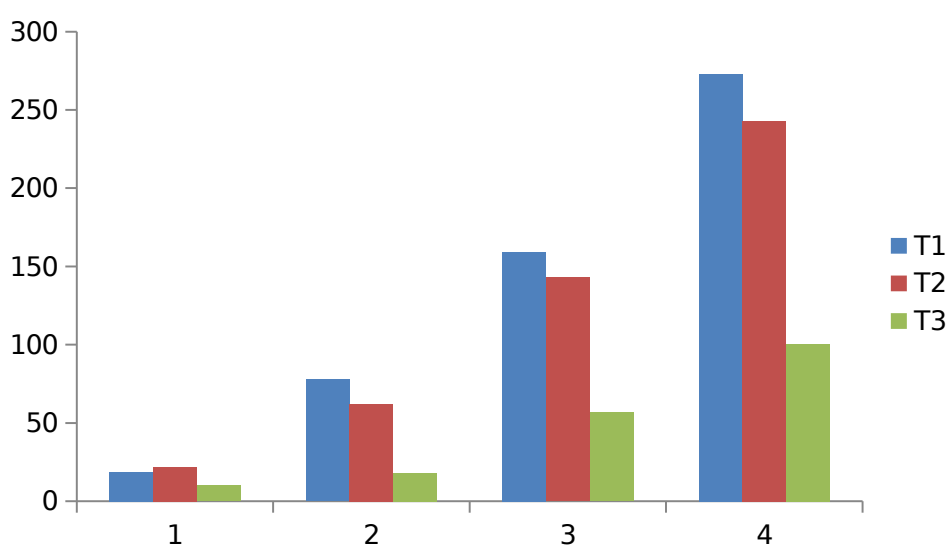
The growth attributes observations recorded at definite intervals of 7 days on the plant height was subjected to t- test and the results are shown in the tables. The results represent the mean data of four plants grown in individual grow bag and the four numbers have been treated as replications. In t-test, the treatments were individually compared with one another i.e.  $T_1$  Vs  $T_2$ ,  $T_2$  Vs  $T_3$ ,  $T_1$  Vs  $T_3$ , where  $T_1$ ,  $T_2$  and  $T_3$  denote respectively plants fertigated automatically inside polyhouse, plants inside the polyhouse with manual fertilizer application and the plants in open field with manual fertilizer application. Here  $T_2$  and  $T_3$  are considered as controls. The results are given in table 4.5 (a), (b) and in fig. 4.1, which showed that at the early stages (1<sup>st</sup> and 2<sup>nd</sup> stages), plant height was non-significant when  $T_1$  was compared with  $T_2$ . This indicated that under both these treatments the conditions were similar for the growth of cucumber and not much variation was obtained statistically even though the automated drip fertigation system in polyhouse ( $T_1$ ) outperformed numerically than the manual fertilizer application in Poly house.

But  $T_1$  and  $T_2$  were statistically significant against  $T_3$ , which is considered to be one of the controls. This indicated that 100% recommended dose of fertigation in a controlled environment like polyhouse could give the maximum plant growth for cucumber. Incorporation of fertilizers in right time and at right quantity could have improved its plant height. These findings are in harmony with the reports of Eltez (1994) in pepper and eggplant with higher plant height when grown in greenhouse compared to open field. Besides these findings are in harmony with pot grown assays which have given good results showing positive effect of nutrients on plant growth and vegetative development especially with application of NPK in splits doses (Jayaprasad and Sulladmath, 1978).

Drip fertigation can enable the application of soluble fertilizers and other chemicals along with irrigation water near to the root zone (Patel and Rajput, 2000; Narda and Chawla, 2002). The application of water and nutrients in small

doses at frequent intervals in the crop root zone ensures their optimum utilization and higher growth (Jayakumar *et al.*, 2014).

The results showed that at the later stages (3<sup>rd</sup> and 4<sup>th</sup> stages), plant height was significant between the individual treatments. T<sub>1</sub> outperformed the other two treatments. This indicated the superiority of the automated drip fertigation system in poly house (T<sub>1</sub>) than the other two treatments. It registered the maximum plant height of 273.0 cm at the 4<sup>th</sup> observation, followed by T<sub>2</sub> with 242.8 cm and T<sub>3</sub> with 100.3 cm respectively. In both the stages the open field cultivation (control) recorded the lowest plant height. The concentration and availability of various nutrients in the soil for plant uptake depends on the soil solution phase which is mainly determined by soil moisture availability. The higher available soil moisture provided due to continuous water and nutrient supply under drip fertigation had led to higher availability of nutrients in the soil and thereby increased the nutrient uptake by the crop, and hence promoting the growth of cucumber. However, apart from the obvious nutritional advantages, there are also clear indications that certain nutrients perform additional functions such as signals that trigger plant growth and development. Changes in phytohormonal balances induced by fertigation treatments played a decisive role in regulating plant development for earlier and better yield (Romheld *et al.*, 2005).



**Fig. 4.1 Influence of different treatments on plant height of cucumber at different stages of growth**

**Table 4.5 (a) Influence of different treatments on plant height of cucumber at fist two stages**

Plant height (cm)	Observations	
	1 <sup>st</sup> stage	2 <sup>nd</sup> stage
T <sub>1</sub>	18.5	77.8
T <sub>2</sub>	22.0	62.0
T <sub>3</sub>	10.0	18.0
T <sub>1</sub> Vs T <sub>2</sub> (t value)	NS	NS
T <sub>2</sub> Vs T <sub>3</sub> (t value)	5.05**	12.61**
T <sub>1</sub> Vs T <sub>3</sub> (t value)	4.20**	9.32**

\*\* Significant at p<0.05; NS - Non significant

**Table 4.5 (b) Influence of different treatments on plant height of cucumber at later stages**

Plant height (cm)	Observations	
	3 <sup>rd</sup> stage	4 <sup>th</sup> stage
T <sub>1</sub>	159.3	273.0
T <sub>2</sub>	142.8	242.8
T <sub>3</sub>	56.5	100.3
T <sub>1</sub> Vs T <sub>2</sub> (t value)	4.34**	6.58**
T <sub>2</sub> Vs T <sub>3</sub> (t value)	8.41**	11.75**
T <sub>1</sub> Vs T <sub>3</sub> (t value)	9.36**	11.23**

\*\* Significant at p<0.05

#### 4.5.2 Effect of treatments on flowering parameters

Events such as first bud formation, first flowering, 50 % flowering, first fruit formation and date of first harvest are given in table 4.6 and fig. 4.2.

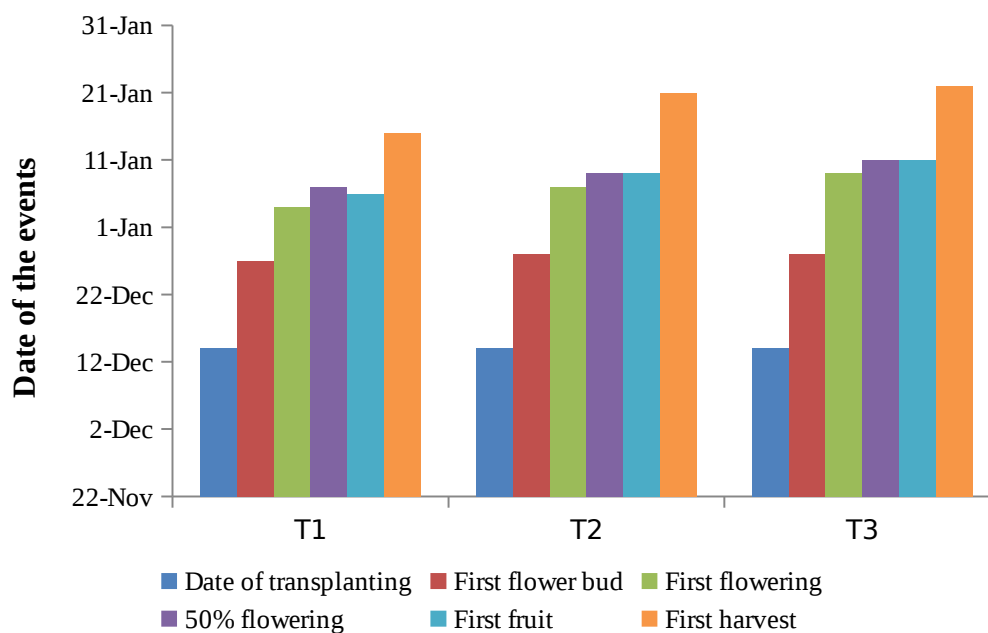
**Table 4.6 Date of occurrence of differing flowering parameters**

Events	Experiment	Control	Open field
First flower bud	27-12-15	28-12-15	28-12-15
First flowering	04-01-16	07-01-16	09-01-16

50% flowering	07-01-16	09-01-16	11-01-16
First fruit	06-01-16	09-01-16	11-01-16
First harvest	15-01-16	21-01-16	22-01-16

From table 4.6, it can be seen that the earliest flowering was obtained in the treatment T<sub>1</sub> (21 days), whereas in the treatment T<sub>2</sub>, it was late by 3 days under polyhouse condition and in T<sub>3</sub> it was late by 5 days. From the date of transplanting it required higher number of days for flowering under open conditions. In open field condition it has been delayed by five days and which may be due to adverse climate factor and high light intensity. The early flowering in polyhouse grown cucumber could be attributed to optimum light intensity and even distribution of radiation over the crop canopy resulting in high photosynthetic activity than at a high light intensity (Aikman, 1989). Further, the optimum levels of nutrient status in the media aided early flowering and the increase in number of pistillate flowers might be due to the vigorous vine growth and more number of branches resulting in increased metabolic activity in cucumber (Bishop *et al.*, 1969).

Similar is the case in 50 per cent flowering, first fruit and first harvest for T<sub>1</sub> and which was followed by T<sub>2</sub> and T<sub>3</sub>. Cucumber crop grown under controlled condition with required temperature has a faster growth rate and induce earlier flowering when compared to the plants grown under open filed condition (Marcelis and Koning, 1995).



**Fig. 4.2 Date of events related to cucumber growth as influence by different treatments**

#### 4.5.3 Leaf area index (LAI)

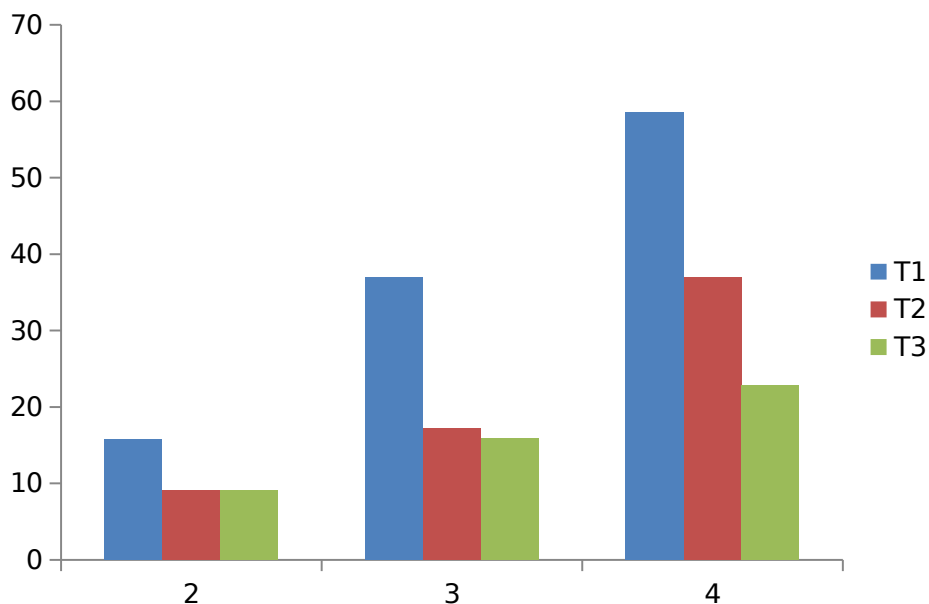
Mean value of length and width of five leaves of four randomly selected plants were taken at weekly intervals from each plot and the leaf area index was computed and t - test was performed and the treatments were compared individually with each other. The computed result is shown in table 4.7 and fig. 4.3.

**Table 4.7 Influence of different treatments on LAI of cucumber plant at three stages of growth**

LAI	2 <sup>nd</sup>	3 <sup>rd</sup>	4 <sup>th</sup>
T <sub>1</sub>	15.80	36.90	58.6
T <sub>2</sub>	9.01	17.19	36.9
T <sub>3</sub>	9.01	15.84	22.8
T <sub>1</sub> Vs T <sub>2</sub> (t value)	7.89**	2.53**	4.229**

T <sub>2</sub> Vs T <sub>3</sub> (t value)	2.82**	2.68**	2.778**
T <sub>1</sub> Vs T <sub>3</sub> (t value)	8.47**	NS	NS

\*\* Significant at p<0.05; NS - Non significant



**Fig. 4.3 Influence of different treatments on LAI of cucumber plant at different stages of growth**

The results showed that leaf area index at various stages of crop growth, before flowering was statistically significant. The table shows the values from 2<sup>nd</sup> stage itself, since in the 1<sup>st</sup> stage, the LAI values are non significant and hence the data is not shown. The results indicate that at all the stages, the values of T<sub>1</sub> were numerically higher, when compared to T<sub>2</sub> and T<sub>3</sub> and were statistically significant except in the last two stages when compared to T<sub>3</sub>.

This indicated that uniform application of fertilizer through drip fertigation could give maximum leaf growth for cucumber. The vegetative growth of the plant is directly related to the nitrogen applied (Klein, *et al.*, 1989). Moreover according to studies conducted by Baruah and Mohan (1991), potassium application is important in leaf growth and development. Nitrogen, phosphorus and potassium are three necessary nutrients which affect the plant growth and the

uniform and frequent application of fertilizer through drip fertigation might have resulted in the better leaf area index. The significance of the T<sub>1</sub> and T<sub>2</sub> over T<sub>3</sub> shows that a control environment like polyhouse will result in more vegetative growth of the plant. Similar findings were recorded in the study conducted by Gantait and Pal (2011).

#### 4.6 Yield data

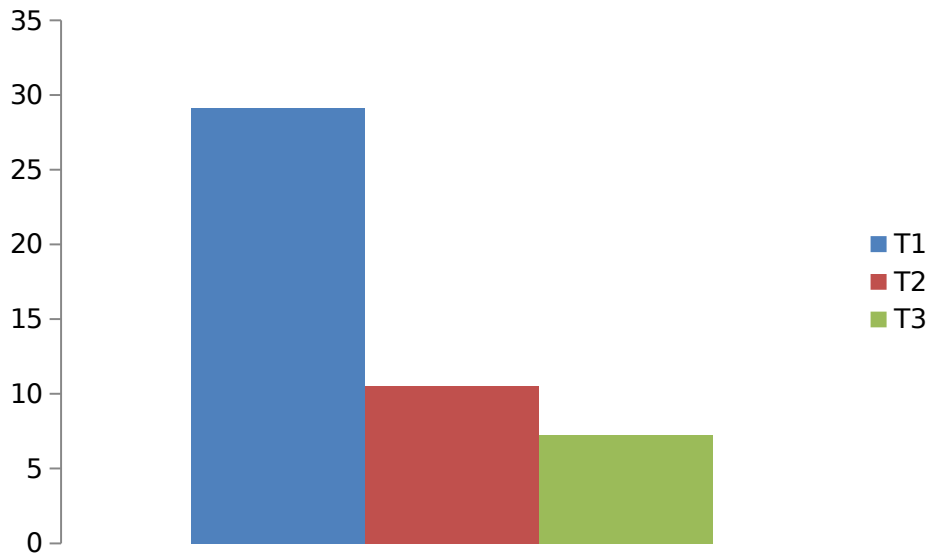
##### 4.6.1 Number of fruits per plant

The yield parameters observations recorded at periodic weekly intervals was compiled and the mean data were subjected to ANOVA. The results represent the mean data of seven randomly selected plants grown in each grow bag and the seven numbers has been treated as replications. The results of the number of fruits per plant are shown in table 4.8 and fig 4.4.

**Table 4.8 Influence of different treatments on number of fruits per plant of the cucumber**

Treatments	No. of fruits/plants
T <sub>1</sub>	29.12 <sup>a</sup>
T <sub>2</sub>	10.50 <sup>b</sup>
T <sub>3</sub>	7.25 <sup>b</sup>
SEd	2.266
CD (P=0.05)	5.388





**Fig. 4.4 Influence of different treatments on number of fruits per plant of cucumber**

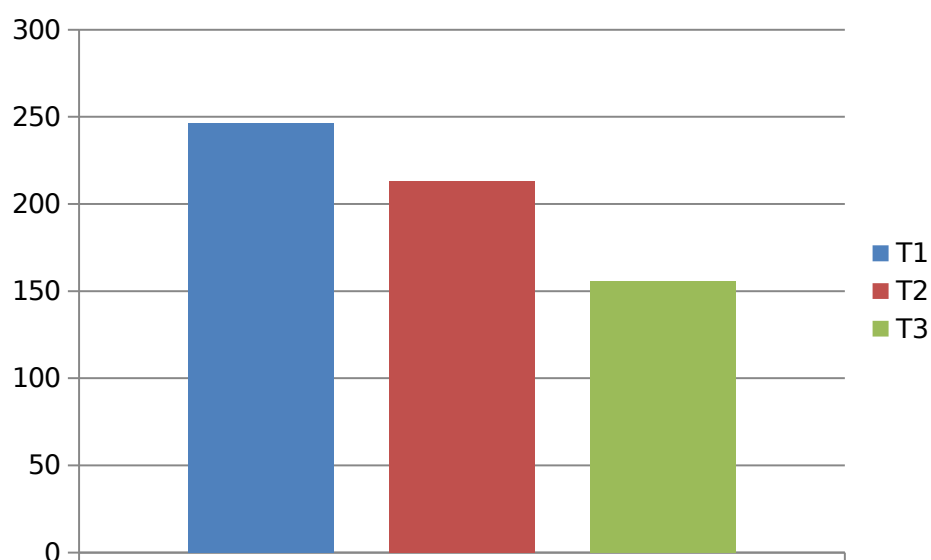
The results showed that the automated drip fertigation system in polyhouse (T<sub>1</sub>) recorded higher number of fruits per plant than the other two treatments and was statistically significant. It registered the maximum number of 29.12 fruits per plant and this was followed by T<sub>2</sub> with 10.50 fruits and T<sub>3</sub> with 7.25 fruits respectively. The increase in number of fruits of T<sub>1</sub> might be due to the increased vegetative growth of the plants grown under fertigation automated polyhouse leading to enhanced nutrient uptake and better water utilization which results in increased rate of photosynthesis and translocation of nutrients into the reproductive part or the produce compared to the conventional method of fertilizer application. The present findings are in accordance with the results of Sharma *et al.* (2011). According to Ramnivas *et al.* (2012), interaction of irrigation and fertigation might have resulted to maximum fruit weight. The increase in number of fruits in T<sub>2</sub> over T<sub>3</sub> might be due to the optimal growth conditions provided inside the polyhouse than the open field.

#### 4.6.2 Weight of the fruit

The yield parameters observations recorded at periodic weekly intervals was compiled and the mean data were subjected to ANOVA .The results represent the mean data of seven randomly selected plants grown in grow bag and the seven numbers have been treated as replications. The obtained results of the mean weight of the fruit were shown in table 4.9 and fig 4.5.

**Table 4.9 Influence of different treatments on weight of the cucumber fruit**

Treatments	Average weight of the single fruit (g)
T <sub>1</sub>	246.4 <sup>a</sup>
T <sub>2</sub>	212.9 <sup>b</sup>
T <sub>3</sub>	155.7 <sup>c</sup>
SEd	13.063
CD (P=0.05)	27.44
CV %	11.90



### **Fig. 4.5 Influence of different treatments on weight of the cucumber fruit**

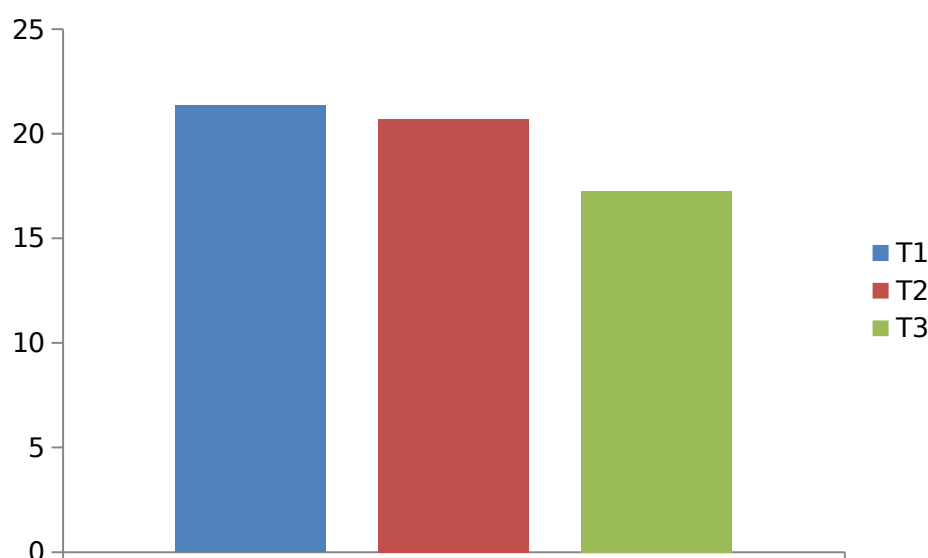
The results showed that the automated drip fertigation system in polyhouse (T<sub>1</sub>) recorded higher fruit weight than the other two treatments. It registered the maximum fruit weight of 246.4 g and this was followed by T<sub>2</sub> with 212.9 g and T<sub>3</sub> with 155.7 g respectively. The increase in yield attributes under automated drip fertigation might be due to enhanced availability and uptake of nutrients leading to enhanced photosynthesis, expansion of leaves and translocation of nutrients to reproductive parts compared to conventional method of soil application of nutrients. Similar findings were also recorded by Gireesha (2003). In irrigated horticultural production systems, increased precision in the application of both water and nutrients can potentially be achieved by simultaneous application via fertigation (Bar-Yosef, 1999). This has the advantage of synchronizing nutrient supply with plant demand (Millard, 1996; Neilsen *et al.*, 1999; Weinbaum *et al.*, 1992), thus enabling reduction in the amount of nutrients applied and reducing environmental impact, besides improving crop productivity (Neilsen and Neilsen, 2002). Shedeed *et al.* (2009) observed significant increase in growth parameters (plant height, LAI, fruit dry weight, total dry weight), yield components (number of fruits /plant, mean fruit weight, fruit yield/plant) and total fruit yield with the application of 100% RDF through fertigation over furrow and drip irrigation and soil application of fertilizers.

#### **4.6.3 Length of the fruit**

The length observations recorded at periodic weekly intervals was compiled and the mean data were subjected to ANOVA. The results represent the mean data of seven randomly selected plants grown in grow bag and the seven numbers has been treated as replications. The obtained results of the mean length of the fruit are shown in table 4.10 and fig 4.6.

**Table 4.10 Influence of different treatments on length of the cucumber fruit**

Treatments	Length (cm)
T <sub>1</sub>	21.35 <sup>a</sup>
T <sub>2</sub>	20.70 <sup>a</sup>
T <sub>3</sub>	17.27 <sup>b</sup>
SEd	0.77
CD (P=0.05)	1.62
CV %	9.85



**Fig. 4.6 Influence of different treatments on length of the cucumber fruit**

The results showed that the automated drip fertigation system in polyhouse (T<sub>1</sub>) recorded longer fruit length than the other two treatments. T<sub>1</sub> registered the maximum fruit length of 21.35 cm and it was followed by T<sub>2</sub> with 20.70 cm and T<sub>3</sub> with 17.27 cm respectively. The increase in length of the fruit might be due to regular water and nutrient supply through drip fertigation, crop plants can complete all metabolic process at appropriate time. The adequate moisture and moisture supply also helps in keeping various enzyme systems active. Therefore, quality of the produce is better in drip fertigated crops as compared to control.

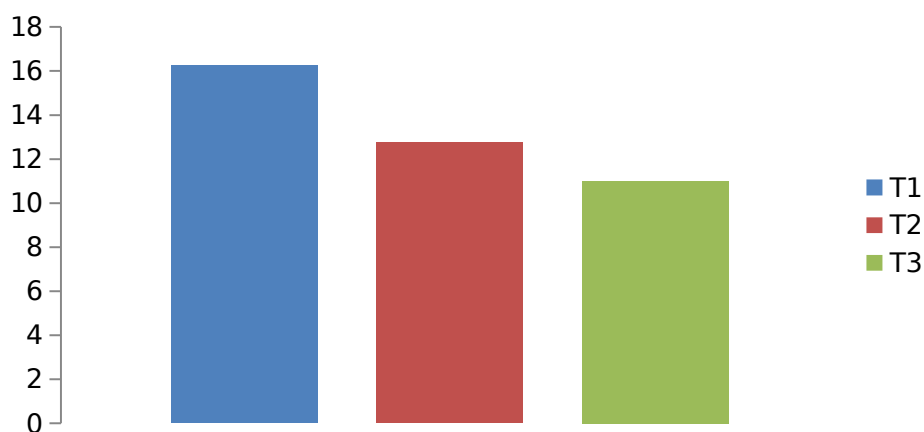
The improved quality with conjunctive use of drip irrigation and fertigation might be due to the fact that drip irrigation and fertigation permits better use of water and nutrients, lower leaching losses and more controllable application of nutrients as compared to other nutrient and water supply methods. These results are in line with the finding of Elkner *et al.* (2001) and Samra (2005).

#### 4.6.4 Equatorial circumference of the fruit

The equatorial circumference of the fruit recorded at weekly intervals was compiled and the mean data were subjected to ANOVA .The results represent the mean data of seven randomly selected plants grown in each grow bag and the seven numbers has been treated as replications. The obtained results of the average equatorial circumference are shown in table 4.11 and fig 4.7.

**Table 4.11 Influence of different treatments on equatorial circumference of the cucumber**

Treatments	Equatorial circumference(cm)
T <sub>1</sub>	16.25
T <sub>2</sub>	12.75
T <sub>3</sub>	11.00
CD (P=0.05)	NS



**Fig. 4.7 Influence of different treatments on equatorial circumference of cucumber**

The results showed that the automated drip fertigation system in polyhouse (T<sub>1</sub>) recorded higher equatorial circumference than the other two treatments. It registered the maximum equatorial circumference of 16.25 cm and this was followed by T<sub>2</sub> with 12.75 cm and T<sub>3</sub> with 11 cm respectively. The reading of T<sub>1</sub> was not statistically significant over the other two treatments but the numerical superiority of the equatorial circumference of the fruits harvested from the polyhouse fertigated automatically was because of the increase in crop growth due to the interaction effect between irrigation and fertigation levels. 100 percentage applications of the scheduled nutrients to the root zone had also contributed to the fruit diameter (Ramnivas *et al.*, 2012). These findings are in agreement with the report of Singh *et al.* (2005) that the trickle irrigation with 100% recommended nitrogen fertilizer gave the maximum fruit circumference, fruit length and fruit weight in papaya. The optimum growth conditions inside the polyhouse may have resulted in the superiority of the equatorial circumference of fruit harvested from T<sub>2</sub> in which the fertilizer was applied manually over the T<sub>3</sub> which is the open field.



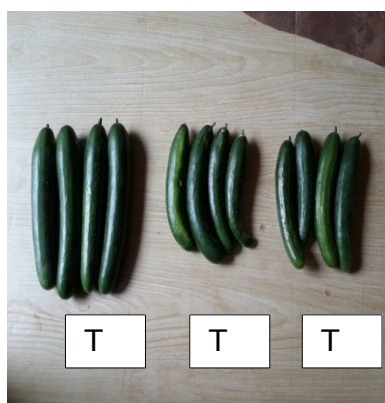
**Plate 4.1 Crops in plot T<sub>1</sub>**



**Plate 4.2 Crops in plot T<sub>2</sub>**



**Plate 4.3 Crops in plot T<sub>3</sub>**



**Plate 4.2 Comparison of fruit size**

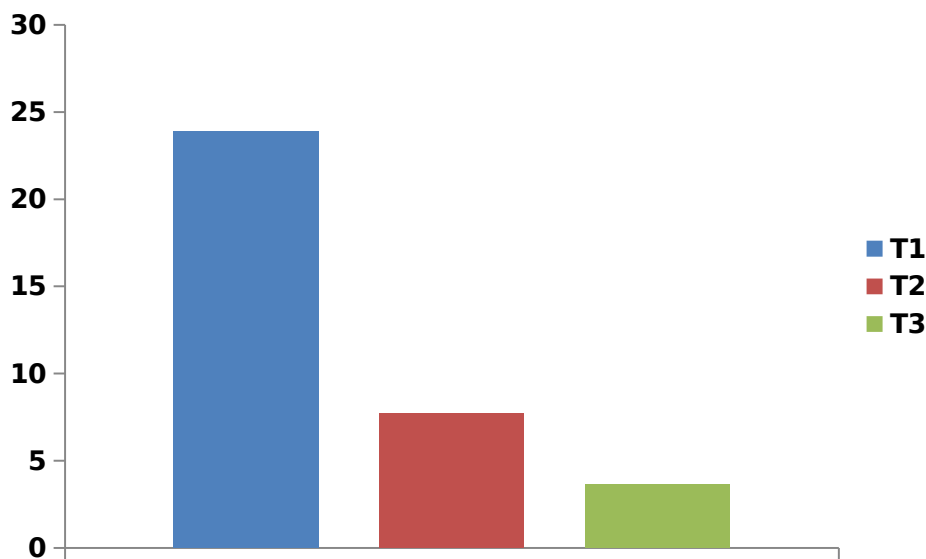
#### 4.6.5 Yield of cucumber

The cumulative yield recorded at periodic weekly intervals was compiled and the mean data were subjected to ANOVA. The results represent the mean data of seven plants selected randomly grown in each grow bag and the seven numbers has been treated as replications. Yield per hectare was arrived based on the mean data obtained per plant. The obtained results of the total yield fruit is shown in Table 4.12 and Fig 4.8

**Table 4.12 Influence of different treatments on yield of the cucumber fruit**

Treatments	Total Yield (t/ha)
T <sub>1</sub>	23.86 <sup>a</sup>

T <sub>2</sub>	7.71 <sup>b</sup>
T <sub>3</sub>	3.63 <sup>c</sup>
SEd	1.16
CD (P=0.05)	2.44
CV %	12.30



**Fig. 4.8 Influence of different treatments on yield of Cucumber**

The results showed that the automated drip fertigation system in polyhouse (T<sub>1</sub>) recorded the higher fruit yield of 23.86 t ha<sup>-1</sup> and this was statistically significant over the other treatments. This was followed by T<sub>2</sub> with 7.71 t ha<sup>-1</sup> and which was also statistically significant against the control treatment (T<sub>3</sub>) which recorded the yield of 3.63 t ha<sup>-1</sup>. This might be due to the combined effect of cultivars, wider spacing, polyhouse cultivation and timely and assured availability of all the nutrients through automated fertigation system. The present results are in agreement with the findings of Arora *et al.* (2006) in greenhouse grown tomato; Ban *et al.* (2006) in melons. Drip fertigation of cucumber adequately sustain favorable vegetative and reproductive growth as compared to conventional



method of fertilizer application. These results are in accordance with the findings of Choudhari and More (2002) in gynoecious cucumber hybrids. In other words, increased nutrient availability and absorption by the crop at the optimum moisture supply coupled with frequent nutrient supply by fertigation and consequent better formation and translocation of assimilates from source to sink might have increased cucumber yield under fertigation. Irrigation systems permit multiple small dose fertilizer injections at different intervals, reducing the risk of leaching compared to fertilizers applied in a single application. This might have resulted in increased nutrient uptake under drip fertigation and as a result biomass production and yield was increased under the treatment T<sub>1</sub>.

Apart from this it was observed that the crop under polyhouse (T<sub>2</sub>) was also statistically significant than the control (T<sub>3</sub>). The possible reason for this is higher fruit weight under polyhouse than open field may be associated with more of assimilates produced in source region and their efficient partition to sinks, as partitioning efficiency is decided by sink strength which was evident from earlier reports of Marcelis (1994) and Rajasekharan and Nandini (2015). Cucumber crop bears equal distribution of fruits all along the stem *i.e.*, at each node, hence every leaf in a node supplies photo assimilates to fruits. This demands optimum PAR (Photosynthetic Active Radiation) and light supply at each layer of leaves, which might have been possible under polyhouse conditions when compared to open conditions as reported by Rajasekharan and Nandini (2015).

The lowest yield under open conditions might be due to the fact that cucumber demands high temperatures, optimum soil moisture and nutrients for satisfactory yield, and under unfavorable climatic conditions, several problems may occur, such as the reduction of female flowers, delay in fruit growth and mineral disorders (Bakker and Sonneveld, 1988) and ultimately resulting in low yield.

## CHAPTER V

### SUMMARY AND CONCLUSION

Crop yield can be increased by providing irrigation at suitable time intervals in correct proportions. For any crop, to get maximum yield, scheduled fertilizer application is highly inevitable. Fertigation is a method of fertilizer application in which fertilizer is incorporated with the irrigation water and applied through micro irrigation systems, so that the fertilizer solution is distributed evenly throughout the field. Automatic fertigation allow farmers to deliver adequate nutrient quantity and concentration with irrigation water to active plant root area throughout the growing season automatically thereby saving labour, money and time.

The study was conducted to develop and evaluate the performance of an automated fertigation system. Field evaluation of the developed automated fertigation system was conducted with salad cucumber crop inside a poly house located at Agricultural Research Station, Anakkayam during the period from December 2015 to March 2016. A comparative analysis was conducted between biometric observations and yield parameters of the three groups of crop, one planted inside the polyhouse and fertigated automatically with the developed system (T<sub>1</sub>) and other two groups, one inside the polyhouse with manual fertilizer application (T<sub>2</sub>) and the other in the open field with manual fertilizer application (T<sub>3</sub>). Biometric observation of four plants selected from each plot was subjected to Student-t test and the yield parameters of seven plants selected from each plot was subjected to ANOVA. The summary and conclusion of the study are presented in this chapter.

On an average, a temperature of 35 °C was maintained inside the poly house whereas a temperature range of 38 °C to 42 °C was observed in the open field. Inside the polyhouse a higher humidity range of 50% to 95% was observed

during day and night hours respectively, whereas in open field it was in a range of 40% to 90%. UV stabilised sheet used for the roofing could reduce the sunlight intensity to an average value of 20000 lux, whereas in open field it was in a range of 70000 lux.

The developed automated fertigation system reduces the chance of over or under fertigation, saves labour and maintains accurate dosage and timing. The system comprises of four main components namely an 8 station timer, three fertilizer tanks with three fertilizer pumps, a mixing tank, level controllers and a fertilizer injection pump. Three fertilizers  $\text{NH}_4\text{NO}_3$ ,  $\text{NH}_4\text{H}_2\text{PO}_4$  and  $\text{K}_2\text{SO}_4$  were filled in the three fertilizer tanks according to the requirement of the plants for the entire growing period and water was filled to these tanks and thorough fertilizer solutions were made with the help of bubblers. These fertiliser solutions prepared in the fertilizer tanks are then carried over to the mixing tank at scheduled proportions using fertilizer pumps. From the mixing tank the mixed solution is pumped to the drip valve with the help of fertilizer injection pump. All these operations were controlled by an 8 station timer in accordance with the signals given by the level controllers installed in each fertilizer tanks and mixing tank. The developed system operates with solar panel generating a power of 250 watt-hours/day on an average along with a battery which makes the system operations possible for 4.4 days without sunshine.

Crop growth parameters like height of the plants, days to initial budding, days to 50% flowering, days to first fruit, days to first harvest and leaf area index were observed for the 3 treatments,  $T_1$ ,  $T_2$  and  $T_3$ , viz. crop grown inside the polyhouse and fertigated using the developed system, crop grown inside the polyhouse with manual fertilizer application and crop grown in the open field with manual fertilizer application respectively. The height of the plants was measured at an interval of 7 days and during early stages  $T_1$  was non-significant when compared with  $T_2$ , even though  $T_1$  outperformed numerically. But  $T_1$  and  $T_2$  were statistically significant against  $T_3$ . In the later stages, plant height was significant

between the individual treatments and T<sub>1</sub> outperformed. It was observed that, early flowering occurred in T<sub>1</sub>, whereas in T<sub>2</sub> it was late by 3 days and in T<sub>3</sub> it was late by 5 days. It was noted, that leaf area index during various stages of crop growth before flowering was statistically significant and at all the stages, the values of T<sub>1</sub> were numerically higher, when compared to T<sub>2</sub> and T<sub>3</sub> and were statistically significant except in the last two stages when compared to T<sub>3</sub>.

The yield parameters such as number of fruits per plant, weight of the fruit, length of the fruit, equatorial circumference of the fruit and total yield in t/ha were recorded. The results showed that the T<sub>1</sub> recorded the higher number of fruits per plant followed by T<sub>2</sub> and T<sub>3</sub> and was statistically significant. It was observed that a higher value of weight, length and equatorial circumference of the fruit was observed in T<sub>1</sub> followed by T<sub>2</sub> and T<sub>3</sub>. The results showed that the automated drip fertigation system in polyhouse (T<sub>1</sub>) recorded the higher fruit yield of 23.86 t ha<sup>-1</sup> and this was statistically significant over the other treatments. This was followed by T<sub>2</sub> with 7.71 t ha<sup>-1</sup> and which was also statistically significant against the control (T<sub>3</sub>) which recorded the yield of 3.63 t ha<sup>-1</sup>.

From the present study it can be inferred that the automated fertigation system installed inside the polyhouse (T<sub>1</sub>) can be considered as the best treatment as it gave the maximum value of yield parameters and biometric observations. Thus it can be concluded that the developed system for automatic fertigation ensured better yield for cucumber variety 'Saniya' grown inside the polyhouse. Moreover, being fully operated with solar power, the system can be installed at remote and rural locations to achieve reduction in the cost of production and to enhance the yield.

Future research may be carried out to compare the system efficiency inside the polyhouse and open field, comparative studies may be conducted between the timer based and sensor based method of fertigation and the system may be modified to wireless control system through GSM modem.

**Appendix I: Fertigation schedule inside automated polyhouse with 186 plants**

no	NH <sub>4</sub> NO <sub>3</sub> (g)	NH <sub>4</sub> H <sub>2</sub> PO <sub>4</sub> (g)	K <sub>2</sub> SO <sub>4</sub> (g)	Time of pumping (min)			Quantity of water/min (l/min)			Total quantity of water			
				P1	P2	P3	P1	P2	P3	P1	P2	P3	
1	600	132	128	3	3	1	1.3	0.7	1.7	3.9	2.1	1.3	
2	600	132	128	3	3	1	1.3	0.7	1.7	3.9	2.1	1.3	
3	200	132	128	1	3	1	1.3	0.7	1.7	1.3	2.1	1.3	
4	200	132	128	1	3	1	1.3	0.7	1.7	1.3	2.1	1.3	
5	0	0	0	0	0	0	1.3	0.7	1.7	0	0	0	
6	200	132	128	1	3	1	1.3	0.7	1.7	1.3	2.1	1.3	
7	200	132	128	1	3	1	1.3	0.7	1.7	1.3	2.1	1.3	
8	200	132	128	1	3	1	1.3	0.7	1.7	1.3	2.1	1.3	
9	200	132	128	1	3	1	1.3	0.7	1.7	1.3	2.1	1.3	
10	0	0	0	0	0	0	1.3	0.7	1.7	0	0	0	
11	200	132	128	1	3	1	1.3	0.7	1.7	1.3	2.1	1.3	
12	200	132	128	1	3	1	1.3	0.7	1.7	1.3	2.1	1.3	
13	200	132	128	1	3	1	1.3	0.7	1.7	1.3	2.1	1.3	
14	200	132	128	1	3	1	1.3	0.7	1.7	1.3	2.1	1.3	
15	0	0	0	0	0	0	1.3	0.7	1.7	0	0	0	
16	200	88	128	1	2	1	1.3	0.7	1.7	1.3	1.4	1.3	
17	200	88	128	1	2	1	1.3	0.7	1.7	1.3	1.4	1.3	
18	200	88	128	1	2	1	1.3	0.7	1.7	1.3	1.4	1.3	
19	200	88	128	1	2	1	1.3	0.7	1.7	1.3	1.4	1.3	
20	0	0	0	0	0	0	1.3	0.7	1.7	0	0	0	
21	200	88	128	1	2	1	1.3	0.7	1.7	1.3	1.4	1.3	
22	200	88	128	1	2	1	1.3	0.7	1.7	1.3	1.4	1.3	
23	200	88	128	1	2	1	1.3	0.7	1.7	1.3	1.4	1.3	
24	200	88	128	1	2	1	1.3	0.7	1.7	1.3	1.4	1.3	
25	0	0	0	0	0	0	1.3	0.7	1.7	0	0	0	
26	200	44	128	1	1	1	1.3	0.7	1.7	1.3	0.7	1.3	
27	200	44	128	1	1	1	1.3	0.7	1.7	1.3	0.7	1.3	
28	200	44	128	1	1	1	1.3	0.7	1.7	1.3	0.7	1.3	
29	200	44	128	1	1	1	1.3	0.7	1.7	1.3	0.7	1.3	
30	0	0	0	0	0	0	1.3	0.7	1.7	0	0	0	
Total (g)	5600g	2464	3072						Total (l)		36.4 l	39.2 l	40.0 l
Total (kg)	6 kg	2.5 kg	3 kg										

**Appendix II: Fertilizer schedule for control plots with 24 plants each**

Sl no	NH <sub>4</sub> NO <sub>3</sub> (g)	NH <sub>4</sub> H <sub>2</sub> PO <sub>4</sub> (g)	K <sub>2</sub> SO <sub>4</sub> (g)	Amount of water taken (l)		
				1	2	3
1	75	16	16	0.49	0.25	0.21
2	75	16	16	0.49	0.25	0.21
3	27	16	16	0.18	0.25	0.21
4	27	16	16	0.18	0.25	0.21
5	0	0	0	0	0	0
6	27	16	16	0.18	0.25	0.21
7	27	16	16	0.18	0.25	0.21
8	27	16	16	0.18	0.25	0.21
9	27	16	16	0.18	0.25	0.21
10	0	0	0	0	0	0
11	27	16	16	0.18	0.25	0.21
12	27	16	16	0.18	0.25	0.21
13	27	16	16	0.18	0.25	0.21
14	27	16	16	0.18	0.25	0.21
15	0	0	0	0	0	0
16	27	10	16	0.18	0.16	0.21
17	27	10	16	0.18	0.16	0.21
18	27	10	16	0.18	0.16	0.21
19	27	10	16	0.18	0.16	0.21
20	0	0	0	0	0	0
21	27	10	16	0.18	0.16	0.21
22	27	10	16	0.18	0.16	0.21
23	27	10	16	0.18	0.16	0.21
24	27	10	16	0.18	0.16	0.21
25	0	0	0	0	0	0
26	27	4	16	0.18	0.063	0.21
27	27	4	16	0.18	0.063	0.21
28	27	4	16	0.18	0.063	0.21
29	27	4	16	0.18	0.063	0.21
30	0	0	0	0	0	0
Total(g)	744	288	384			
Total (kg)	0.744 kg	0.288 kg	0.384 kg			

### Appendix III: Calculation of amount of fertilizer required

According to the POP recommendations, cucumber plant requires, 104 kg  $\text{NH}_4\text{NO}_3$ , 40 kg 12-61-0 and 55 kg SOP per hectare.

$$\begin{aligned}\text{Number of cucumber plants per hectare} &= 10000/\text{spacing} \\ &= 10000/2*1.5 \\ &= 3333 \text{ Plants/ha}\end{aligned}$$

$$\begin{aligned}\text{Amount of } \text{NH}_4\text{NO}_3 \text{ required for 1 plant} &= 104/3333 \\ &= 0.031 \text{ kg}\end{aligned}$$

$$\begin{aligned}\text{Amount of 12-61-0 required for 1 plant} &= 40/3333 \\ &= 0.012 \text{ kg}\end{aligned}$$

$$\begin{aligned}\text{Amount of SOP required for 1 plant} &= 55/3333 \\ &= 0.016 \text{ kg}\end{aligned}$$

So, total amount of each fertilizer required inside the automated fertigation polyhouse with 186 plants,

$$\begin{aligned}\text{Total amount of } \text{NH}_4\text{NO}_3 \text{ required} &= 0.031*186 \\ &= 5.766 \text{ kg}\end{aligned}$$

$$\begin{aligned}\text{Total amount of 12-61-0 required} &= 0.012*186 \\ &= 2.2 \text{ kg}\end{aligned}$$

$$\begin{aligned}\text{Total amount of SOP required} &= 0.016*186 \\ &= 2.9 \text{ kg}\end{aligned}$$

Total amount of each fertilizer required in the control plots with 24 plants,

$$\begin{aligned}\text{Total amount of } \text{NH}_4\text{NO}_3 \text{ required} &= 0.031*24 \\ &= 0.744 \text{ kg}\end{aligned}$$

Total amount of 12-61-0 required	=0.012*24
	=0.288kg
Total amount of SOP required	=0.016*24
	=0.384kg



## REFERENCES

- Ahmad, U., Subrata, M. and Arif, C. 2011. Speaking plant approach for automatic fertigation system in greenhouse. *Int. J. signal processing, image processing and pattern recognition*. 4: 1-9.
- Aikman, D.P. 1989. Potential increase in photosynthetic efficiency from the redistribution of solar radiation in a crop. *J. Exp. Bot.* 40: 855-864.
- Alam, A. and Kumar, A. 1980. Micro Irrigation system-past, present and future. In: Singh, H.P., Kaushish, S.P., Kumar, A., Murthy, T.S., Jose, C. and Samuel, E. (eds.), *Micro Irrigation*. Central Board of Irrigation and Power, New Delhi, pp. 2-17.
- Anon. 2008. *Technical bulletin on fertigation*. National committee on plasticulture application in horticulture, Newdelhi.
- Arora, S.K., Bhatia, A.K., Singh, V.P. and Yadav, S.P.S. 2006. Performance of indeterminate tomato hybrids under greenhouse conditions of north Indian plains. *Haryana J Hortic Sci.* 35 (3&4): 292-294.
- Ashokaraja. and Kumar,A. 2001.Status and Issues of fertigation in India. In: Singh, H.P., Kaushish, S.P., Kumar, A., Murthy, T.S., Jose, C. and Samuel, E. (eds.), *Micro Irrigation*. Central Board of Irrigation and Power, New Delhi, 61p.
- Bachav, S.M. 1995. Fertigation in India. In: *International Symposium on Fertigation*, Israel Institute of Technology, Israel, March 26-April 1, pp. 11-24.
- Bakker, J.C. and Sonneveld, C. 1988. Calcium deficiency of glasshouse cucumber as affected by environmental humidity and mineral nutrition. *J. Hortic. Sci.* 63(2).

- Ban, D., Goreta, S., and Borosic, J. 2006. Plant spacing and cultivar affect melon growth and yield components. *Sci. Hortic.* 109: 238-243.
- Bar- Yosef, B. 1999. Advances in fertigation. *Adv. Agron.* 65: 1-70.
- Baruah, P.J. and Mohan, N.K. 1991. Effect of potassium on LAI, phylochrome and number of leaves of banana. *Banana.Newsl.*14:21-22.
- Bishop, R.F., Chipmon, E.W., and Mae eachern, C. R., 1969. Effect of nitrogen, phosphorous and potassium on yield and nutrient levels in laminate and petioles of pickling cucumber. *Can. J.Soil Sci.* 49: 297-404.
- Blanco, F.F. and Folegatti, M.V. 2003. A new method for estimating the leaf area index of cucumber and tomato plants. *Hortic. Brasileira.* 21(4): 666-669.
- Boman, B. and Obreza, T. 2002. Fertigation nutrient sources and application considerations for citrus, University of Florida, IFAS Circular 1410. Available: <http://edis.ifas.ufl.edu/CH185>.
- Bozkurt, S. and Mansuroglu, G.S. 2009. The effects of drip line depths and irrigation levels on yield, quality and water use characteristics of lettuce. *Afr. J. Biotechnol.* 10(7): 3370-3379.
- Brajuel, E. and Maillard. 2006. Development evaluation of an automated prototype for the fertigation management in a closed system. In: *3<sup>rd</sup> IS on HORTIMODEL*, 21 September 2006.
- Chandran, M.K., Sushanth, C.M., Mammen, G., Surendran, U., and Joseph, E.J. 2011. *Drip irrigation manual*. Centre for Water Resources Development and Management, Kerala.
- Choudhari, S.M. and More, T.A. 2002. Fertigation, fertilizer and spacing requirement of tropical gynoecious cucumber hybrids. *Acta Hortic.* 588: 233-240.

- Elkner, K., Kaniszewshi, S., and Dysko, J. 2001. Effects of fertigation on the content of ascorbic acid, carotenoids and dietary fiber in tomato fruits. *Veg. Crops Res. Bull.* 61: 69-77.
- Etlez, R.Z. 1999. Effect of various media on eggplant and pepper quality. *Acta Hort.* 366: 176-182.
- Farina, E., Battista, D., and Palagi, M. 2007. Automation of irrigation in hydroponics by FDR sensors-Experimental results from field trials. In: *8<sup>th</sup> IS on protected cultivation in mild winter climates*, 16 July 2007.
- Gantait, S.S. and Pal, P. 2011. Comparative performance of spray chrysanthemum cultivars under polyhouse and open-field cultivation at different dates of planting. *J. Hort. Sci.* 6(2): 123-129.
- Gireesha, G. 2003. Crop establishment studies to increase yield in irrigated cotton (cv. MCU 12). M. Sc.(Ag) Thesis. Tamil Nadu Agricultural University, Coimbatore.
- Gomez, K. A. and Gomez, A.A. 1984. *Statistical procedure for agricultural research* (2<sup>nd</sup> Ed.). Wiley Interscience Publication, Newyork.
- Gowda, N.V. 1996. Nutrition and irrigation management in green house. In: Singh, H.P., Kaushish, S.P., Kumar, A., Murthy, T.S., Jose, C. and Samuel, E. (eds.), *Micro Irrigation*. Central Board of Irrigation and Power, New Delhi, 431p.
- Hagin and Lowengart, A. 1996. Fertigation for minimizing environmental pollution by fertilizers. *Fertil. Res.*, 43(3): 5-7.
- Hakkim, V.M.A. and Chand, A.R.J. 2014. Effect of drip irrigation levels on yield of salad cucumber under naturally ventilated polyhouse. *IOSR J. Eng.* 4(4): 18-21.

- Haynes, R.J. 1985. Principles of fertilizer use for trickle irrigated crops. *Fertil. Res.* 6: 235-255.
- Haynes, R.J. 1985. Principles of fertilizer use for trickle irrigated crops. *Fertil. Res.* 6: 235-255.
- Hochumuth, G.J. and Smajstrla, A.G. 2003 Fertilizer application and management for micro (drip) – Irrigated vegetables in Florida. Available:[http://www.seaagri.com/docs/fertilizer\\_application\\_for\\_drip\\_irrigated\\_vegetables.pdf](http://www.seaagri.com/docs/fertilizer_application_for_drip_irrigated_vegetables.pdf).
- Iacomi, C., Rosca, I., Madjar, R., Iacomi, B., Popcsu, V., Varzaru, G., and Sfeetcu, C. 2014. Automation and computer-based technology for small vegetable farm holders. *Sci. Pap. Ser. Agron.* 7: 2285-5785.
- Imas, P. 1999. Recent techniques in fertigation of horticultural crops in Israel. In: *Workshop on recent trends in nutrition management in horticultural crops*. 11-12 February 1999. Dapoli, Maharashtra, India.
- Jain, V.K., Shukla, K.N., and Singh, P.K. 2001. Response of potato under drip irrigation and plastic mulching, In: Singh, H.P., Kaushish, S.P., Kumar, A., Murthy, T.S., Jose, C. and Samuel, E. (eds.), *Micro Irrigation*. Central Board of Irrigation and Power, New Delhi, pp. 49-27.
- Jat, R., Wani, S., Sahrawat, K., Singh, P. and Dhaka. Fertigation in vegetable crops for higher productivity and resource use efficiency. *Indian J. Fertil.* 7(3): 22-37.
- Jayakumar, M., Surendran, U. and Manickasundaram, P. 2014. Drip fertigation effects on yield, nutrient uptake and soil fertility of Bt Cotton in semi arid tropics. *Int. J. Plant Prod.* 8(3).

- Jayaprasad, K.V. and Sulladmath, S. 1978. Influence of N, P and K on growth, production and quality in hybrid tea rose CV. Super Star. *S. Ind. Hortic.* 122-131.
- KAU (Kerala Agricultural University) 2011. *Package of Practises Recommendations: Crops* (14<sup>th</sup> Ed.). Kerala Agricultural University, Thrissur, 175p.
- Kaur, B. and Kumar, D. 2013. Development of automated nutrients composition control fertigation system. *Int. J. Comput. Sci. Eng. Appl.* 3: 2-65.
- Khan, M.M., Shivashangar, K., Manohar, K. R., Sreerama, R. and Kariyanna. 1999. In: Singh, H.P., Kaushish, S.P., Kumar, A., Murthy, T.S., Jose, C. and Samuel, E. (eds.), *Micro Irrigation*. Central Board of Irrigation and Power, New Delhi, 79p.
- Klein, L., Levin, L., Bar-Yosef, B., Assaf, R. and Berkovitz, A. 1989. Drip nitrogen fertigation of 'Starking Delicious' apple trees. *Plant and Soil*.119(2): 305-314.
- Kumar, A. 1992. Fertigation through drip irrigation. In: Singh, H.P., Kaushish, S.P., Kumar, A., Murthy, T.S., Jose, C. and Samuel, E. (eds.), *Micro Irrigation*. Central Board of Irrigation and Power, New Delhi, pp. 349-356.
- Kumar, V.G., Mani, T.D., and Selvaraj, P.K. 2007. Irrigaion and fertigation scheduling under drip irrigation in brinjal crop. *IJBSM*.1(2): 72-76.
- Kumari, G.V.L. and Anitha, S. 2006. Nutrient management in Chilli based cropping system. *Indian J. Crop Sci.*1(1-2): 209-210.
- Li, J., Zhang, J., and Rao, M. 2004. Wetting patterns and nitrogen distributions as affected by fertigation strategies from a surface point source. *Agric. Water Manag.* 67(2): 89-104.

- Locascio, S.J. 2000. Management of irrigation for vegetables: past, present, and future. *Hortic. Technol.* 15: 482 – 485.
- Manickasundaram, P. 2005. Principles and practices of fertigation. In: Kandasamy, O.S., Velayudham, K., Ramasamy, S., Muthukrishnan, P., Devasenapathy, P. and Velayuthan, A. *Farming for the future: Ecological and Economic Issues and Strategies*. s.l., s.n., pp. 257 – 262.
- Marcelis, L. F. M. 1994. A simulation model for dry matter partitioning in cucumber. *An. of Bot.* 74(1):43-52.
- Marcelis, L.F.M. and Koning De, A.N.M.. 1995. Biomass partitioning in plants. In: Bakker, J.C., Bot, G.P.A., Challa, H., Van de Braak, N.J. (Eds.), *Greenhouse Climate Control ± An Integrated Approach*. WageningenPers, Wageningen, pp. 84-92.
- Mikkelsen, R.L. 1989. Phosphorous fertilization through drip irrigation. *J. Prod. Agric.* 2(3): 279-286.
- Millard, P. 1996. Ecophysiology of the internal cycling of nitrogen for tree growth. *J Plant Nutr. Soil Sci.* 159 (1): 1–10.
- Mortvedt, J.J. 1997. Mineral nutrition of green house crops. In: Singh, H.P., Kaushish, S.P., Kumar, A., Murthy, T.S., Jose, C. and Samuel, E. (eds.), *Micro Irrigation*. Central Board of Irrigation and Power, New Delhi, 430p.
- Nakayama, F.S. and Bucks, D.A. 1991. Water quality in drip/trickle irrigation: a review. *J. Irrig. Sci.*, 12:187–192.
- Narayanamoorthy, A. 2001. Adoption of recommended use of fertilizers and its impacts on paddy yield: an analysis of determinants in ground water irrigated region. *Artha Vijnana*. 38 (4): 387-406.
- Narayanamoorthy, A. 2006. Potential for drip and sprinkler irrigation in India. In: *Proceedings of the workshop on analyses of hydrological, social and*

- ecological issues of the NRLP*, Colombo, Sri Lanka .International water management institute, Sri Lanka. 500 p.
- Narda, N.K. and Chawla, J.K. 2002. A simple nitrate sub-model for trickle fertigated potatoes. *Irrig. Drain.* 51: 361–371.
- Neilsen, D. and Neilsen, G.H. 2002. Efficient use of nitrogen and water in high density apple orchards.*Hortic.Technology.* 12:19-25.
- Neilsen, G.H., Neilsen, D. and Peryea, F.J. 1999. Response of soil and irrigated fruit trees to fertigation or broadcast applications of nitrogen, phosphorus and potassium. *Hortic. Technol.* 9:393-401.
- Neto, A.J.S., Zolnier, S. and Lopes, D.C. Development and evaluation of an automated system for fertigation control in soilless tomato production. *Comput.and Electr. in Agric.* 103 (2014) 17–25.
- Patel, N. and Rajput, T.B.S. 2011. Simulation and modelling of water movement in potato (*Solanumtuberosum*). *The Indian J. Agric. Sci.* 81: 25-32.
- Prabhakar, M. and Hebbar, S.S. 1996. Micro Irrigation and Fertigation in Capsicum and tomato. In: *National Seminar on Problems and Prospects of Micro Irrigation – A Critical Appraisal*, Bangalore, 19-20 November 1999, pp.60-68.
- Raine, S.R. and McCarthy, A.C. 2014. Advances in intelligent and autonomous system to improve irrigation and fertilizer efficiency. Available:[http://www.massey.ac.nz/~flrc/workshops/14/Manuscripts/Paper\\_Raine\\_2014.pdf](http://www.massey.ac.nz/~flrc/workshops/14/Manuscripts/Paper_Raine_2014.pdf).
- Rajasekharan, G. and Nandini, K. 2015. Photosynthetic characters in relation to yield of cucumber grown in naturally ventilated poly house. *J. of Trop. Agric.* 53(2): 200-205.

- Ramnivas, Kaushik, R. A., Sarolia, D. K., Pareek, S. and Singh V. 2012. Effect of irrigation and fertigation scheduling on growth and yield of guava (*Psidiumguajava*L.) under meadow orcharding. *Afr. J. Agric. Res.* 7(47): 6350-6356.
- Romheld, V., Jimenez-Becker, S., Neumann, G., Patrick, J., Onyango, G., Puelschen, L., Spreer, W. and Bangerth, F. 2005. Non nutritional fertigation effects as a challenge for improved production and quality in horticulture. In *Fertigation Proceedings: Selected Papers of the IPI-NATESC-CAU-CAAS International Symposium on Fertigation, 20-24 September 2005, Beijing/China.*
- Salih, J.E.M., Adom, A.H., and Shaakaf, A.Y.M. Solar Powered Automated Fertigation Control System for CucumisMelo L. Cultivation in Green House. *APCBEE Procedia.* 4(2012):79 – 87.
- Samra, J.S. 2005. Micro-irrigation and fertigation to enhance water use efficiency in India. *Souvenir-International Conference on Plastic-culture and Precision Farming.* 21-29.
- Sharma, A., Kaushik, R.A., Sarolia, D.K. and Sharma R.P. 2011. Response of cultivars, plant geometry and methods of fertilizer application on parthenocarpic cucumber (*Cucumissativus*L.) under zero energy polyhouse condition. *Veg. Sci.* 38(2): 215-217.
- Shedeed, I., Sahar, M., Zaghoul, A. and Yassen, A. 2009. Effect of Method and Rate of Fertilizer Application under Drip Irrigation on Yield and Nutrient Uptake by Tomato. *Ozean J. of Appl. Sci.* 2(2): 139-147.
- Shirgure, P.S. 2013. Citrus fertigation—a technology of water and fertilizers saving. *Sci. J. Crop Sci.* 2(5): 56-66.



- Singh, A.K., Khanna, M.D., Chakraborty and Kumar, A. 2001. In: Singh, H.P., Kaushish, S.P., Kumar, A., Murthy, T.S., Jose, C. and Samuel, E. (eds.), *Micro Irrigation*. Central Board of Irrigation and Power, New Delhi, 442p.
- Singh, H.P., Kumar, A., and Samuel, J. C.2000. Micro irrigation for horticultural crops. *Indian Hortic.* 45(1): 272-276.
- Singh, V.K. 2009. Advances in plastic Material Technology: A Global Perspective. In: *Proceedings of the International Conference on Plasticsulture and Precision Farming*, November 17 -21, pp. 523-528.
- Singh, S.K., Singh, P.K., Singh, K.K. and Shukla. 2001. Studies on Drip Irrigation Installation for litchi in Bhabhar region of Uttar Pradesh. In: Singh, H.P., Kaushish, S.P., Kumar, A., Murthy, T.S., Jose, C. and Samuel, E. (eds.), *Micro Irrigation*. Central Board of Irrigation and Power, New Delhi, 297p.
- Singh, H.K. and Singh, A.K.P. 2005.Effect of refrigeration on fruit growth and yield of papaya with drip irrigation. *Environ. Ecol.* 23: 692-695.
- Singhandhube, R.B., Rao, G.G.S.N., Patil, N.G. and Brahmanand, P.B. 2003. Fertigation studies and irrigation scheduling in drip irrigation system in tomato crop. *Eur. J. Agron.* pp. 1-17.
- Sreedhara, D. S., Kerutagi, M.G., Basavaraja, H., Kunnal, L.B. and Dodamani, M.T. 2013. Economics of capsicum production under protected conditions in Northern Karnataka. *Karnataka J. Agric. Sci.* 26(2):217-219.
- Srinivas, K. 1999. Micro Irrigation and Fertigation. In: Singh, H.P., Kaushish, S.P., Kumar, A., Murthy, T.S., Jose, C. and Samuel, E. (eds.), *Micro Irrigation*. Central Board of Irrigation and Power, New Delhi, 79p.

- Vargheese, A., Balan, M.T., Sajna, A. and Swetha, K.P. 2014. Cowpea inside polyhouse with varying irrigation and fertigation levels. *Int. J. Eng. Res. Dev.* 10: 18-21.
- Weinbaum, S.A., Johnson, R. S., and DeJong, T. M. 1992. Causes and consequences of over fertilization in orchards. *Hortic.Tech.* 2(1): 112-121.
- Wilson, C. and Bauer, M. 2005. Drip Irrigation for home gardens. Available: [http://prepperchicks0.homestead.com/~local/~Preview/Drip\\_Irrigation\\_for\\_Home\\_Gardens.pdf](http://prepperchicks0.homestead.com/~local/~Preview/Drip_Irrigation_for_Home_Gardens.pdf).
- Yasser, E., Essam, A., and Magdy, T. 2009. Impact of fertigation scheduling on Tomato yield under Arid Ecosystem Conditions. *Res. J. Agric. Biol. Sci.* 5(3): 280-286.

## **ABSTRACT**

Automated fertigation system is a highly advanced system for water and fertilizer administration in irrigated agriculture. It promises the application of water in right quantity along with right fertilizer at right time, thereby reducing fertilizer loss and labour resulting in saving of money with the help of an automated mechanism. The present study was undertaken to develop a timer based automated fertigation system using an FIP and to evaluate the performance of the system. Field evaluation of the developed automated fertigation system was carried out by growing salad cucumber variety 'Saniya' in grow bags inside a poly house located at Agricultural Research Station, Anakkayam. A comparative evaluation was carried out between biometric observations and yield parameters of the two sets of crop grown inside the polyhouse, one fertigated automatically with the developed system and the other one with manual fertilizer application and a third group of plants grown in the open field with manual fertilizer application. Data collected was subjected to statistical scrutiny viz., ANOVA (Analysis of Variance) and Student-t test. The main crop growth parameters like height of the plant, days to first flowering, days to 50 percentage flowering, days to initial budding, days to first harvest and leaf area index were observed. Yield parameters viz. size of the fruit, number of fruits harvested per plant and average yield were recorded during the study. Values of all these parameters were found to be better for the crops grown inside the polyhouse with automated fertigation compared to the other two. The developed system operates using solar panel generating a power of 250 W on an average along with a battery, which makes the system operations possible up to 4.4 days without sunshine. Hence it can be concluded that the developed automated fertigation system can ensure better yield for salad cucumber variety 'Saniya' grown inside the polyhouse.