

# Package *Of* Practices Recommendations Crops 2016



Kerala  
Agricultural  
University



# PACKAGE OF PRACTICES RECOMMENDATIONS: CROPS 2016

15<sup>th</sup> edition

Chief Editor  
S. ESTELITTA

Editors  
BINO P. BONNY, S. HELEN,  
A. SUMA



DIRECTORATE OF EXTENSION  
KERALA AGRICULTURAL UNIVERSITY  
THRISSUR - 680 651, KERALA, INDIA

English

## Package of Practices Recommendations : Crops 2016

First published	1973
Second edition	1974
Third edition	1975
Fourth edition	1976
Fifth edition	1978
Sixth edition	1981
Seventh edition	1983
Eighth edition	1986
Ninth edition	1989
Tenth edition	1993
Eleventh edition	1996
Twelfth edition	2002
Twelfth edition (Reprint)	2003
Thirteenth edition	2007
Thirteenth edition (Reprint)	2008
Fourteenth edition	2011
Fifteenth edition	2016
Fifteenth edition (Reprint)	2017

November 2017

Copies: 1000

January 2018

Copies: 1000

Price: ₹ 300/-

Technical guidance

Dr. P. V. Balachandran

Dr. P. B. Pushpalatha

Former Directors of Extension

Published by :

Dr. Jiju P. Alex

Director of Extension

Kerala Agricultural University

Mannuthy, Thrissur - 680 651, India

© Kerala Agricultural University 2016

All Rights Reserved

Cover :

Sri. M. A. Vasudevan

Type set :

Smt. C. B. Deepa

Printed at :

KAU Press, Mannuthy - 680 651

Citation :

Kerala Agricultural University 2016. Package of Practices Recommendations : Crops  
15<sup>th</sup> edition. Kerala Agricultural University, Thrissur - 392 p.

Internet edition : [www.kau.in](http://www.kau.in)

## FOREWORD

The Package of Practices: Crops (PoP), published by the Kerala Agricultural University is widely revered as the most authentic guide of farmers, scientists, extension officers in line departments, non-governmental organisations and all other stakeholders in the field of Agriculture.

This new version of PoP sports not only a fresh look but has also been substantially updated to cover the latest technologies and developments. I hope the package of knowledge and expertise reflected in this compendium will help to enhance the productivity of our crops and aid to realise the goals of food security, safety and nutritional security.

Bringing out this voluminous edition, the hallmark of which is authenticity than popularity, needs great perseverance and patience. I take this opportunity to congratulate one and all who have toiled behind this attractive edition of PoP.

I dedicate this repository of valuable information and recommendations to the farming community of Kerala.



30<sup>th</sup> June 2016  
Vellanikkara

Prof. (Dr.) P. Rajendran  
Vice-Chancellor

## PREFACE

Technology intensive farming that ensure high productivity without deteriorating the environment is the challenge of the day. Kerala Agricultural University remains committed to this cause through technology generation and transfer programmes. In these programmes sustainable food production that ensure livelihood security of farmers and food safety of society remain the prime concerns. These commitments are reiterated in the 15<sup>th</sup> edition of the Package of Practices Recommendations : Crops 2016 also.

All efforts are made to maintain the long standing credentials of the publication by including crops suitable for the diverse agro climatic regions of Kerala. All technical aspects of farming that include high yielding varieties of crops, use of bioinputs, small farm mechanization, waste management, precision farming and introduction of under-exploited fruits, vegetables, tubers and medicinal plants find a place in this. The generated technologies were presented, deliberated and finalized in a series of workshops attended by scientists, extension officers, farmers and input dealers.

I am honoured to publish this much appreciated reference document on the agricultural technological developments of the State. I am sure it will serve as a guide to the extension personnel and farming community in the furtherance of agriculture in our state. My appreciation goes to all the researchers, administrators, extension personnel, farmers and other staff members who have contributed their expertise, time and energy to bring out this valuable document. Special thanks are also due to the Directors of ICAR institutes in Kerala, Chairpersons of all Commodity Boards who contributed in making this publication worthy. Technical support of Dr. D. Ambikadevi Professor, RARS, Kumarakom and Dr. Joy M. Associate Professor COA, Vellayani also deserves special mention.

I wish this edition of the Package of Practices Recommendations: Crops 2016 will be a driving force for the scientific transformation of Kerala's farming sector.

30<sup>th</sup> June 2016  
Mannuthy

Dr. S. Estelitta  
Director of Extension

## INTRODUCTION

It is with immense pleasure that I look forward to the release of the Package of Practices Recommendation : Crops 2016. This is the culmination of painstaking efforts of research leading to standardization of agro techniques, proven management of pests and diseases with emphasis on 'safe to eat food'. These technologies emanating from actual field experiments, committed efforts of several scientists, vetting at various levels, interaction and presentation before eminent scientists of SAU and ICAR, officers of department of agriculture/development department and commodity boards had reached its final approval at the POP workshop.

This release of the POP recommendation is the final lap of a relay of various activities so that this reliable guide for all persons engaged in agriculture finds meaning and relevance. Besides serving as a ready reckoner for farmers, field officers and students, this POP is presented in the most simple understandable form that it is totally farmer centric and the same can be understood by anyone.

I will be failing in my duties if I do not place on record the tremendous service rendered by our scientists who have contributed to this final outcome. My colleagues in the Directorate of Research, Dr. Jim Thomas, Dr. V. S. Devadas, Dr. Pathummal Beevi and Dr. Sally K. Mathew of the College of Horticulture have put in strenuous efforts and need to be acknowledged.

Total coverage of all cultivation aspects and problems of crops grown in the state have been our focus. I hope this objective has been served. But agriculture being so dynamic can never be complete and the Directorate of Research welcomes all constructive criticism in the best interest of all stakeholders and farmers in particular.

30<sup>th</sup> June 2016  
Vellanikkara

Dr. Sajan Kurien  
Director of Research

# CONTENTS

	Page		Page
Cereals and Millets		Vegetables	
Rice	.. 1	Amaranth	.. 183
Maize	.. 42	Okra	.. 184
Sorghum	.. 42	Cucurbitaceous vegetables	
Ragi	.. 43	Bitter gourd	.. 186
Pulses		Snake gourd	.. 187
Black gram	.. 44	Cucumber and oriental pickling melon	.. 188
Cowpea	.. 44	Watermelon	.. 189
French bean	.. 48	Bottle gourd	.. 190
Green gram	.. 49	Pumpkin	.. 190
Green pea	.. 49	Ash gourd	.. 191
Horse gram	.. 50	Solanaceous vegetables	
Red gram	.. 50	Brinjal	.. 192
Soybean	.. 51	Chilli	.. 193
Tubers		Tomato	.. 194
Elephant Foot Yam	.. 53	Vegetable cowpea	.. 195
Xanthosoma	.. 54	Cool season vegetables	
Colocasia	.. 56	Cabbage	.. 196
Greater yam	.. 57	Cauliflower	.. 196
Lesser yam	.. 58	Carrot	.. 197
White yam	.. 59	Beet root	.. 198
Sweet potato	.. 59	Radish	.. 198
Tapioca	.. 62	Potato	.. 199
Coleus	.. 67	Onion	.. 199
Commercial crops		Garlic	.. 200
Cashew	.. 68	Minor vegetables	.. 201
Cotton	.. 80	Tips for vegetable seed production	.. 203
Rubber	.. 81	Guidelines for Homestead cultivation of	
Sugarcane	.. 93	Vegetables in Rain shelters	.. 207
Oil seeds		Fruits	
Coconut	.. 96	Banana	.. 208
Groundnut	.. 112	Guava	.. 215
Oil palm	.. 113	Indian gooseberry	.. 216
Sesame	.. 116	Jack	.. 216
Spices and Condiments		Mandarin orange	.. 218
Cardamom	.. 118	Mango	.. 219
Cinnamon	.. 124	Papaya	.. 221
Clove	.. 126	Pineapple	.. 223
Vanilla	.. 129	Sapota	.. 227
Ginger	.. 130	West Indian Cherry	.. 227
Mango-ginger	.. 133	Apple	.. 228
Nutmeg	.. 134	Ornamental plants	
Black Pepper	.. 136	Anthurium	.. 230
Turmeric	.. 146	Orchids	.. 231
Camboge	.. 148	Jasmine	.. 233
Tamarind	.. 151	Gladiolus	.. 234
Beverages and Stimulants		Tuberose	.. 235
Arecanut	.. 152	Crossandra	.. 236
Betel vine	.. 156	Marigold	.. 237
Cocoa	.. 158	China aster	.. 238
Coffee	.. 167	Medicinal and Aromatic plants	
Tea	.. 176	Eucalyptus	.. 239
Tobacco	.. 181	Kacholam	.. 239

	Page		Page
Lemongrass	.. 241	Kampakam	.. 288
Palmarosa	.. 242	Irul	.. 289
Vetiver	.. 243	Mahagony	.. 290
Chethikoduveli	.. 244	Thembavu	.. 291
Neela amari	.. 244	Venga	.. 292
Chengazhinirkizhangu	.. 245	Chadachi	.. 293
Kasthurimanjal	.. 246	Punna	.. 293
Chittaratha	.. 247	Agroforestry systems	.. 294
Nilappana	.. 249	Others	
Jeevakom	.. 250	Agro ecological zones of Kerala	.. 295
Adapathiyam	.. 251	Composting : Vermicompost and coirpith compost	.. 308
Asoka	.. 252	Biofertilizers	.. 311
Kanjiram	.. 253	Guidelines for maximizing fertilizer use efficiency	.. 315
Thippali	.. 254	Beekeeping	.. 318
Neem	.. 255	Sericulture	.. 324
Pathimugham	.. 255	Rodents and their control	.. 327
Chittadalotakam	.. 256	Control of Loranthus	.. 331
Koovalam	.. 256	Biocontrol of Salvinia	.. 331
Thulasi	.. 257	Biocontrol of papaya mealy bug using parasitoid	.. 332
Karinochi	.. 257	Ecofriendly management of water hyacinth in water bodies	.. 332
Kattavazha	.. 257	Biocontrol agents against plant pathogens	.. 333
Arrow root	.. 258	Soil solarisation	.. 334
Danthappala	.. 258	Mushroom cultivation	.. 336
Brahmi	.. 258	Tissue culture propagation of crops	.. 339
Kurumthotti	.. 259	Improving the Keeping quality of fruits and vegetables	.. 340
Medicinal plants as intercrops in Homesteads	.. 259	Low cost technology for irrigation and protected cultivation	.. 341
Fodder crops		Farm machinery suitable for Kerala	.. 343
Guinea grass	.. 260	Appendices	
Gamba grass	.. 261	1. Agroclimatic classification of Kerala	.. 350
Setaria grass	.. 261	2. Average nutrient content of common manures and fertilizers	.. 352
Hybrid napier	.. 263	3. Neutralising value of liming materials	.. 352
Para grass	.. 264	4. Conversion of nutrients (kg ha <sup>-1</sup> ) to common fertilizers (kg ha <sup>-1</sup> )	.. 353
Congosignal grass	.. 265	5. Guide for mixing fertilizers	.. 353
Subabul	.. 266	6. Calculation of insecticide and fungicide formulations	.. 354
Hedge lucerne	.. 267	7. Home made insecticidal preparations	.. 355
Agathi	.. 267	8. Preparation of common fungicides	.. 356
Shevri	.. 268	9. Fumigants and its use	.. 357
Fodder cowpea	.. 268	10. Pesticide guide	.. 358
Stylo	.. 269	11. Details of pesticides available in the market	.. 367
Fodder maize	.. 271	12. List of pesticides/pesticide formulations banned in India	.. 380
Fodder sorghum	.. 272	13. Ad hoc Recommendations for the management of pests and diseases in selected crops	.. 383
Green manure crops		14. Ad hoc Recommendations for management of secondary and micro nutrients	.. 385
Sun hemp	.. 272	15. Institutions under the Kerala Agricultural University	.. 391
Daincha	.. 272		
Wild indigo	.. 272		
Indigo	.. 272		
Green leaf manure crops			
Glinicidia	.. 273		
Subabul	.. 273		
Cassia	.. 273		
Agroforestry			
Ailanthus or Matti	.. 274		
Casuarina	.. 275		
Eucalyptus	.. 277		
Mangium	.. 278		
Teak	.. 280		
Thomy bamboo	.. 282		
Wild jack or Aini	.. 284		
Rosewood	.. 284		
Sandal	.. 286		



# CEREALS AND MILLETS

## RICE (*Oryza sativa*)

Rice can be cultivated under a variety of climatic and soil conditions. Rice cultivation is conditioned by temperature parameters at the different phases of growth. The critical mean temperature for flowering and fertilization ranges from 16° to 20°C, whereas, during ripening, the range is from 18° to 32°C. Temperature beyond 35°C affects grain filling. Rice comes up well in different soil types. For normal growth, a pH range of 5.0-8.0 is suitable.

In general, rice can be grown as transplanted or direct sown crop during three

seasons as shown in Table 1 depending on the agroclimatic situations.

During second crop, for higher yield in irrigated photosensitive high yielding varieties in Palakkad district, the crop commencement may be adjusted in such a way that it flowers only during the second fortnight of December. This facilitates proper integration with the weather; better utilization of applied fertilizers and high filling percentage. The rice varieties for Kerala and their characteristics are given as Table 2 and 3 respectively.

Table 1. Different rice growing seasons of Kerala

Agroclimatic situations	Seasons	Period	
		From	To
General	Virippu (I crop/autumn)	April-May	Sept-Oct
	Mundakan (II crop/winter)	Sept-Oct	Dec-Jan
	Puncha (III crop/summer)	Dec-Jan	Mar-Apr
Onattukara	Virippu (I crop/autumn)	April	August
	Mundakan (II crop/winter)	Aug-Sept	Dec-Jan
	Third crop (where HYVs come up)	Feb-Mar	April
Kuttanad	Additional Crop	May-June	Aug-Sept
	Puncha	Oct-Nov	Feb-Mar
Kari soils	Additional Crop	June-July	Sept-Oct
Kole (Single cropped area)	Mundakan (Kadumkrishi)	Aug-Sept	Dec-Jan
Pokkali	Virippu (I crop/autumn)	May-June	Sept-Oct
	Oorumundakan	Aug-Sept	Dec-Jan
Kaipad	Virippu (I crop/autumn)	April-May	Sept-Oct
High ranges	Nancha	May-June	Oct-Nov
	Puncha	Dec-Jan	Apr-May

Table 2. Rice varieties suited for different situations

Region/Type of land	Seasons	Varieties
Upland (Modan land) Purely rainfed	First crop	PTB 28, PTB 29, PTB 30, Suvamamodan, Annapooma, Matta Triveni, Swamaprabha, Rohini, Aiswarya, Vaishak, Harsha
Palliyals (Myals) Single crop terraced	First crop	Short duration : Rohini, Annapooma, Matta Triveni, Jyothi, Kairali, Kanchana, Harsha, Karthika, Ahalya, Prathyasa Medium duration : Aswathy, Sabari, Bharathy, Jaya, Aiswarya, Aathira. Long duration : Mahsuri
Double crop wetlands : a. Semi-dry cultivation	First crop	Short duration : Matta Triveni, Annapooma, Jyothi, Aruna, Makom, Swamaprabha, Ahalya, Varsha, Rohini, Karthika, Revathi, Remanika, Krishnanjana, Kanchana, Harsha, Kairali, Kunjukunju Vama, Kunjukunju Priya, Prathyasa Medium duration : Aswathy, Sabari, Bharathy, Jaya, Arathy, Remya, Kanakom, Ranjini, Pavithra, Panchami, Uma, Aathira, Aiswarya, Pavizham, Bhadra Long duration : Mahsuri
	Second crop	Any of the varieties suggested for the first crop season (Except Rohini)
b. Transplanted	First crop	Short duration : Annapooma, Matta Triveni, Jyothi, Swamaprabha, Kairali, Kanchana, Karthika, Aruna, Makom, Revathi, Remanika, Krishnanjana, Varsha, Rohini, Ahalya, Kunjukunju Vama, Kunjukunju Priya, Prathyasa Medium duration : Jaya, Sabari, Bharathy, Aswathy, Aathira, Aiswarya, Pavizham, Remya, Kanakom, Ranjini, Pavithra, Panchami, Uma Long duration : Mangala Mahsuri, Pranava, Mahsuri, Jaiva
	Second crop	Short duration : Annapooma, Matta Triveni, Jyothi, Kairali, Kanchana, Karthika, Makom, Revathi, Remanika, Krishnanjana, Kunjukunju Vama, Kunjukunju Priya, Prathyasa Medium duration : Jaya, Sabari, Bharathy, Aswathy, Aathira, Aiswarya, Pavizham, Remya, Kanakom, Ranjini, Pavithra, Panchami, Uma, Karishma, Sampada, Jaiva Long duration : Mangala Mahsuri, Karuna, Rasmi, Nila, Makaram, Kumbham, Dhanu, Anashwara, Mahsuri
	Third crop	Short duration : Annapooma, Matta Triveni, Jyothi, Aruna, Swamaprabha, Kairali, Kanchana, Karthika, Makom, Revathi, Remanika, Krishnanjana, Ahalya, Harsha, Varsha, Prathyasa Medium duration : Jaya, Sabari, Bharathy, Aathira, Aiswarya, Pavizham, Remya, Kanakom, Ranjini, Pavithra, Panchami, Uma, Jaiva

Kuttanad area	Puncha	Short duration : Karthika, Makom, Jyothi, Matta Triveni, Annapoorna, Revathi, Remanika, Krishnanjana, Prathyasa Medium duration : Kanakom, Jaya, Sabari, Bharathy, Ranjini, Pavithra, Panchami, Uma, Gouri, Bhadra, Asha, Pavizham, Sreyas
	Additional crop	Short duration : Karthika, Makom, Aruna, Jyothi, Matta Triveni, Annapoorna, Revathi, Remanika, Krishnanjana, Prathyasa, Sreyas Medium duration : Pavizham, Remya, Kanakom, Jaya, Sabari, Ranjini, Pavithra, Panchami, Uma
Kari soils	Additional Crop	Short duration : Krishnanjana, Vyttila 6 Medium duration : Uma, Vyttila 2
Kole area	Mundakan	Extra short duration : Hraswa Short duration : Karthika, Makom, Aruna, Jyothi, Onam, Bhagya, Matta Triveni, Annapoorna, Revathi, Remanika, Krishnanjana, Ahalya, Varsha, Swamaprabha, Kanchana, Kairali, Manupriya, Prathyasa Medium duration : Pavizham, Remya, Kanakom, Jaya, Ranjini, Pavithra, Panchami, Uma, Bhadra, Aswathy, Sabari, Bharathy and Aiswarya
Pokkali area	First crop	Vyttila-1, Vyttila-2, Vyttila-3, Vyttila-4, Vyttila-5, Vyttila-6, Vyttila-7, Vyttila-8, Vyttila-9
Kaipad tract	First crop	Ezhome-1, Ezhome-2, Ezhome-3, Ezhome-4
Deepill-drained regions of southern	First crop	Remya, Arathi, Uma
	Second crop	Kottarakkara-1, Lakshmi, Nila, Makaram, Kumbham, Mangala Mahsuri
Waterlogged and flooded areas	First crop	IR-5, Pankaj, Jagannath, H4, Mahsuri, Neeraja, Mangala Mahsuri
Oorumundakan	Second crop	Late duration : Sagara, Amritha
Onattukara and coastal sandy areas a. Where HYVs do not come up	First crop	PTB 23
	Second crop	PTB 20

b. Where HYVs come up well	First crop	Short duration : Annapoorna, Matta Triveni, Jyothi, Chingam Bhagya, Rohini, Onam, Aruna, Makom, Karthika, Revathi, Remanika, Krishnanjana, Prathyasa Medium duration : Jaya, Sabari, Bharathy, Aswathy, Pavizham, Remya, Kanakom, Arathi, Renjini, Pavithra, Panchami, Uma
	Second crop	Short duration : Annapoorna, Matta Triveni, Jyothi, Makom, Karthika, Revathi, Remanika, Krishnanjana Medium duration : Jaya, Sabari, Bharathy, Aswathy, Bhadra, Asha, Pavizham, Remya, Kanakom, Dhanya, Anaswara, Dhanu (season bound), Ranjini, Pavithra, Panchami, Uma
	Third crop	Short duration : Annapoorna, Matta Triveni, Rohini, Makom, Revathi, Remanika, Krishnanjana, Prathyasa Medium duration : Jaya, Sabari, Bharathy, Aswathy, Pavizham, Remya, Kanakom, Ranjini, Pavithra, Panchami, Uma, Karishma
Poonthalpadam		Neeraja, Swetha, Ponmani
High altitude area : a. Single crop areas		Aswathy, Jaya, Sabari, Mahsuri, Bhadra, IR 8, Aathira, Uma, Deepthi
b. Double crop areas	First crop	Aswathy, Jaya, Sabari, Bharathy, Bhadra, Deepthi, Aathira, IR-8, Uma
	Second crop	Aswathy, Jaya, Sabari, Bharathy, Bhadra, Deepthi, Aathira, IR-8, Uma
c. Eastern lateritic regions of Kollam and Alappuzha districts	Second crop	Lakshmi, Makaram, Kumbham, Thulam
Koottumundakan	First crop	Samyuktha, Swamapraha, Vaishak, Karthika, Aiswarya
	Second crop	Makaram, Kumbham
Chittoor black soil	First crop	ASD 16, ASD 17, Mahsuri, Varsha, ADT 43, Ranjini
	Second crop	Ponni, Vellaponni, Ponmani, ASD 16, ASD 17, Pranava, Karuna, Swetha, Bhadra

Table 3. Important characteristics of varieties recommended for cultivation

Sl. No.	Variety (days)	Duration	Bran colour; grain type	Characteristics
Extra-short duration				
1	Hraswa (Cul 24-20)	75-80	Red, medium bold	Ideal as a contingent variety for areas where there is crop loss. Susceptible to leaf folder. Raised only as direct sown crop
Short duration				
1	Kattamodan (PTB 28)	110-115	Red, long bold	For uplands (modan). Tolerant to drought
2	Karutha Modan (PTB 29)	105-110	Red, long bold	-do- Tall
3	Chuvanna Modan (PTB 30)	105-110	Red, long bold	-do- Tall
4	Annapoorna (PTB 35)	95-100	Red, short bold	Suitable for direct seeding. Susceptible to blast, sheath blight and BPH. Suited for I and III crop seasons
5	Rohini (PTB 36)	85-105	White, long bold	Performs well during Virippu season. Not recommended for mundakan season. Suitable for direct seeding
6	Triveni (PTB 38)	100-105	White, long bold	Tolerant to BPH. Susceptible to blast and sheath blight
7	Jyothi (PTB 39)	110-115	Red, long bold	Moderately tolerant to BPH and blast; susceptible to sheath blight; suitable for direct seeding, transplanting and special systems of Kole and Kuttanad
8	Swamaprabha (PTB 43)	105-110	White, long bold	Suited for upland (modan) and for all the three seasons in the wet-lands. Susceptible to sheath blight and bacterial blight. Moderately resistant to stem borer. A good first crop component in Koottumundakan
9	Matta Triveni (PTB 45)	100-105	Red, medium bold	Tolerant to BPH, susceptible to blast and sheath blight. Suitable for I and III crop
10	Kairali (PTB 49)	110-115	Red, long bold	Moderately resistant to blast, blight, gall midge and leaf folder. Can be cultivated in all the three seasons

11	Kanchana (PTB 50)	105-110	Red, long bold	Suitable for Kole and Kuttanad regions. Resistant to blight, blast, stem borer and gall midge. Suitable for all seasons
12	Karthika (MO 7)	105-110	Red, long bold	Suitable for growing in all the three seasons. Moderate resistance to sheath blight, sheath rot and BPH. A good first crop component in Koottumundakan
13	Aruna (MO 8)	100-110	Red, medium bold	Tolerant to BPH and stem borer; moderately resistant to gall midge, sheath rot. Dormancy up to one month. Specifically suited to wet season
14	Makom (MO 9)	100-110	Red, short bold	Moderately resistant to pests like BPH, stem borer; gall midge, leaf folder and diseases like sheath blight and sheath rot. Dormancy up to one month. Specifically suited for wet season. Can be cultivated in all the three seasons
15	Remanika (MO 15)	100-105	Red, short bold	Dwarf, medium tillering, resistant to BPH and moderately resistant to gall midge
16	Revathi (MO 17)	105-110	Red, medium bold	Dwarf, medium tillering, resistant to BPH and moderately resistant to gall midge. Dormancy upto 3 weeks. Suited to all the three seasons especially to additional crop of Kuttanad
17	Krishnanjana (MO 19)	105-110	Red, medium bold	Medium tillering, resistant to BPH and dormancy upto 3 weeks, suited to all seasons especially to kari lands of Kuttanad, tolerant to iron toxicity
18	Bhagya (Kayankulam2)	100	Red	Suitable for first crop season in Onattukara and eastern lateritic region. Drought resistant in the early growth phases. Moderately tolerant to blight, stem borer, leaf roller and case worm
19	Onam (Kayankulam3)	95	Red	Drought tolerant in the early growth phases. Moderately resistant to blight, sheath blight and blast. Suited for dry sowing in the first crop season of Onattukara region
20	ASD 17	100-105	White, short bold	Good grain quality and high yielding

21	Ahalya	90-100	Red	Good cooking quality, tolerant to leaf folder and moisture stress in the early growth phase
22	Harsha (PTB 55)	105-110	Red, long bold	Suitable for direct seeding in rainfed lowlands. Moderate resistance to blast and moisture stress
23	Varsha (PTB 56)	110-115	Red, long bold	Suitable for direct seeding and transplanting in irrigated lowlands. Moderate resistance to blue beetle
24	Kunjukunju Vama(VK-1)	110-115	Red, short bold	Photo-insensitive, moderately tolerant to major pests like gall fly, leaf folder, whorl maggot and stem borer. Adapted for double cropped areas of Palakkad, Thrissur and Ernakulam districts as direct seeded or transplanted crop. Leaf sheath and apicules are purple pigmented
25	Kunjukunju Priya(VK-2)	105-110	Red, short bold	Photo-insensitive, moderately tolerant to major pests like gall fly, leaf folder, whorl maggot and stem borer. Adapted for double cropped areas of Palakkad, Thrissur and Ernakulam districts as direct seeded or transplanted crop. This is a non-pigmented variety
26	Chingam	95-100	Red, short bold	Photo-insensitive semi-tall variety suitable for first crop season in Onattukara. Moderately resistant to sheath blight and brown leaf spot
27	Manupriya	105-110	Red, long bold	Suitable for Kole lands. Tolerant to sheath blight, brown spot, blast, stem borer and gall midge. Suitable for all seasons
28	Prathyasa (MO-21)	100-110	Red, long bold	Non-lodging, Photoinsensitive, semi-tall variety, suitable for Kuttanad. Moderately resistant to gall midge. BPH, sheath blight and sheath rot
29	Samyuktha (PTB 59)	112-117	Red, short bold	Suitable for Koottumundakan system of cultivation with Makaram in Central zone
30	ASD 16	110-115	White, short bold	Good grain quality, high yield
Medium duration				
1	Jaya	120-125	White, long bold	Very high yield potential, highly susceptible to BPH and other pests

2	Aswathy (PTB 37)	120-125	White, long bold	Suitable for dry sowing in the first crop season
3	Sabari (PTB 40)	130-135	Red, long bold	Susceptible to sheath blight
4	Bharathy (PTB 41)	120-125	Red, long bold	Tolerant to BPH, moderately resistant to blast, suitable for dry sowing
5	Suvamamodan (PTB 42)	110-115	White	Suitable for dry sown conditions, medium tall, moderately resistant to pests and diseases
6	Jayathi (PTB 46)	120-125	White	Resistant to BPH, green leaf hopper, leaf folder, blast and bacterial leaf streak, non-lodging, semi-tall, suitable for all the three seasons
7	Aathira (PTB 51)	120-130	Red, short bold	Semi-tall, non-lodging, moderate resistance to blast and blight diseases and BPH. Suited for I and II crop seasons and also for hilly tracts
8	Aiswarya (PTB 52)	120-125	Red, long bold	Suitable for modan. Resistant to blast and blight diseases. Resistant to BPH. Suited for first and second crop seasons
9	Anashwara (PTB- 58)	125-130	Red, medium bold	Photosensitive, semi-tall variety, suitable only for Mundakan season showing reduced lodging nature. Moderate resistant to blast, sheath blight, leaf folder, stem borer and gall fly
10	Bhadra (MO 4)	120-125 (125-135 for addl. crop)	Red, short bold	Suitable for puncha season in Kuttanad region. Low susceptibility to pests and diseases. Tolerant to BPH. Weakly photosensitive
11	Asha (MO 5)	115-120	Red, medium bold	Suitable for both seasons of Kuttanad. Moderately resistant to pests and diseases. Tolerant to BPH
12	Pavizham (MO 6)	115-120	Red, short bold	Easy to thresh. Fairly resistant to BPH. Moderately resistant to stack burn and sheath rot and fairly resistant to sheath blight
13	Renya (MO 10)	110-120	Red, long bold	Moderately resistant to BPH, gall midge, sheath blight and sheath rot, semi-tall variety. Suitable for all the three seasons. Seed dormancy upto one month
14	Kanakom (MO 11)	120-125	Red, medium bold	Resistant to BPH and moderately resistant to stem borer. Resistant to diseases like rice tungro virus and blast. Moderately resistant to bacterial blight. Semi-tall variety suitable for all the three seasons



15	Ranjini (MO 12)	115-120	Red, medium bold	Dwarf, resistant to blast and BPH
16	Pavithra (MO 13)	115-120	Red, medium bold	Dwarf, medium tillering, resistant to BPH and GM Biotype-5
17	Panchami (MO 14)	115-120	Red, medium bold	Dwarf, medium tillering, resistant to BPH and GM Biotype-5
18	Uma (MO 16)	115-120 Punja 120-135	Red, medium bold	Non lodging, resistant to BPH and GM bold Biotype-5. Dormancy upto 3 weeks. Suited to three seasons especially to additional Virippu crop season of Kuttanad
19	Karishma (MO 18)	115-120	Red, medium bold	Dwarf, medium tillering, resistant to BPH and medium resistant to GM. Suited to three seasons especially to kari lands of Kuttanad; tolerant to iron toxicity
20	Gouri (MO 20)	115-120	Red, medium bold	Medium tall, non-lodging, moderately resistant to sheath blight. Suitable for Punja and additional crop seasons of Kuttanad, Mundakan season of Kole lands, first and second crop seasons in double cropped wet lands
21	Sreyas (MO 22)	115-120	Red	Moderately resistant to sheath blight, sheath rot, BLB and false smut; grain yield 7-7.5 t ha <sup>1</sup>
22	Vyttila- 1 (Chootupokali-Tall)	115	Red	Suitable for Pokkali areas
23	Vyttila- 2 (Cheruvirippu Tall)	125-130	Red, bold	Suitable for Virippu season in the saline areas of Emakulam and Alappuzha districts
24	Vyttila- 3	110-115	Red	Suitable for Virippu season in the coastal saline areas of Emakulam and Alappuzha districts
25	Vyttila- 4	120-125	Red	Suitable for Virippu season in the coastal saline areas (Pokkali ecosystem) and other flood prone areas and deep water situations
26	Vyttila- 5	115-120	Red	Tall, moderately lodging, tolerant to major diseases and pests except BLB, leaf scald, stem borer, leaf folder and rice bug

27	Vyttila- 6	105-110	Red, medium bold	Semi tall, non-lodging, tolerant to salinity, acidity and submergence. Suitable for Virippu season in the coastal saline areas (Pokkali ecosystem)
28	Vyttila-7	110-115	White long slender	Semi tall, non-lodging, high yielding, saline tolerant, suitable for coastal saline ecosystem of Kerala
29	Vyttila-8	115-120	Red, medium bold	Medium tall, non-lodging, high yielding saline tolerant, suitable for coastal saline ecosystem of Kerala
30	Vyttila-9	110-115	Red, medium	Suitable for Kharif season in the high saline coastal areas. It is a high yielding saline tolerant variety having submergence tolerance also
31	Ezhome-2	125-130	Red, medium bold	Suitable for virippu season in the saline coastal Kaipad areas of North Kerala. Non lodging with medium height, non shattering awn-less grains with good cooking qualities. No pest and disease incidence at Kaipad field condition
32	Ezhome- 3	120-125	Red	Medium duration variety tolerant to medium salinity suited to Kaipad and Pokkali soils during Kharif and Rabi seasons
33	Aarathi (ACV-1)	120-135	Red	Seed dormancy upto one month. Recommended for southern region for Virippu season for delayed sowing and for situations where over-aged seedling may have to be planted. Moderately resistant to sheath blight, sheath rot and BPH
34	Vaishak (PTB 60)	117-125	Red, short bold	Suitable for direct seeding during Kharif season in the uplands. Tolerant to moisture stress, resistant to blue beetle, moderate resistance to stem borer and whorl maggot
35	Sampada	130-135	White	Semi dwarf, Non lodging, high yielding medium slender white kernel rice variety suitable for export with good cooking quality, high milling percentage (72.7%) and head rice recovery - 70.1%. Tolerant to Blast, RTD and WBPH
Longduration				
1	Lakshmi (Kayankulam.1)	175-180	Red	Suitable for second crop season. Moderately resistant to leaf roller, blast, blight and sheath blight, fairly resistant to stem borer

2	Dhanya (Kayamkulam4)	160-165	Red	Photosensitive, moderately resistant to stem borer, gall midge, sheath blight and blast.
3	Rashmi (PTB44)	150-160	Red	Suitable for growing in the second crop as the mundakan for Kootumundakan system. Resistant to leaf folder and tolerant to gall midge
4	Neeraja (PTB47)	140-150	White	Moderately resistant to leaf folder; resistant to blast and moderately susceptible to sheath blight, non-lodging, photosensitive, dormant, suited to flood prone and water logged areas and ponthal padams
5	Nila (PTB48)	160-180	Red, short bold	Photosensitive, capable of producing good grain and straw yields under low fertilizer application. Suitable for Karinkora cultivation. Highly resistant to thrips, BPH and moderately resistant to gall midge, stem borer and sheath blight. Can be cultivated in areas where water supply is assured till the middle of January
6	Mangala Mahsuri (PTB53)	140-145	Red, medium slender	Multiple resistant, tolerant to iron toxicity and waterlogging. Good response to low fertilizer regimes
7	Karuna (PTB54)	140-145	Red, long	Multiple resistant, tolerant to iron toxicity, bold good response to low fertilizer regimes, susceptible to brown spot. Specific to II crop season
8	Kottarakara-1 (Cheradi)	140-145	Red	For waterlogged deep soils
9	Makaram (KTR2)	160-165	Red, short bold	Photosensitive; suitable for eastern lateritic region; II crop component in Kootumundakan system
10	Kumbham (KTR3)	165-175	Red, short bold	Photosensitive, tolerant to lodging; suitable for eastern lateritic region; II crop component in Kootumundakan system
11	Pankaj (Semi tall)	135-140	White	For ill-drained deep soils, susceptible to leaf blight
12	H4 (Tall)	125-145	Red, bold	For ill-drained deep soils
13	Mahsuri (Tall)	125-145	White, fine rice	Excessive shedding of grains at maturity, susceptible to blast

14	Sagara	180-190	Red	Photosensitive
15	Amritha	165	Red	HY long duration salt tolerant paddy variety suited for Oru mundakan tract
16	Deepthi	150-160	Red	Semi-tall, photo-insensitive, moderately resistant to blast, leaf folder and stem borer; moderately resistant to drought
17	Ponni	140-145	White, medium slender	Fine grain quality rice
18	White Ponni	135-140	White, medium slender	Fine grain quality rice
19	Ponmani	160-165	White, short bold	Resistant to BPH; high yield potential
20	Pranava	130-135	White, medium slender	Multiple resistant. Suitable for the black cotton soils of Chittoor
21	Swetha (PTB-57)	135-140	White, short bold	Suitable for black cotton soils of Chittoor taluk as a transplanted II crop
22	Dhanu	150-160	Red, short bold	Photosensitive variety suitable for the second crop in Onattukara. Tolerant to sheath blight, brown leaf spot and stem borer
23	Thulam	150	Red, short bold	Semi-tall, photosensitive, non-lodging, non-shattering, tolerant to stem borer, leaf roller and flooding, suitable for eastern lateritic region during second crop season
24	Ezhome-1	135-145	Red, bold medium	Suitable for virippu season in the saline coastal Kaipad areas of North Kerala. Non lodging with large number of sturdy culm of medium height and with purple coloured base. Non shattering awn-less grains with purple coloured apiculus. Good cooking qualities. There is no pest and disease incidence at Kaipad field condition
25	Ezhome-4	135-140	White	HY long duration paddy suitable for Kaipad lands and non-saline flooded tracts
26	Jaiva	130-135	White	HY photo insensitive rice variety developed for organic farming in ordinary non-saline wet lands

Tips on quality seed production in rice and maintenance of viability of stored seeds

Ensure that the seeds for further multiplication are either from a research station or government farm or recognized seed producers.

The land used for seed production should be free from volunteer plants of other varieties grown previously.

To ensure genetic purity, a minimum isolation distance of 3 m from other varieties may be given in the field. Harvesting for seed purpose can also be done leaving a border row of 3 m within the field.

Rogue diseased plants, weeds and off-types in time.

Line planting facilitates roguing and giving alleyways of 30 cm after every 3 m helps in manuring, plant protection operations and supervision.

Drain water at least one week before harvesting to ensure that the plants attain uniform maturity at harvesting. Harvest the crop when 80 per cent of the grains in a panicle are mature (at physiological maturity).

During summer months, ensure that the plants get sufficient water at dough stage till maturity.

Thresh the sheaves on the same day of harvest, as seeds of heaped sheaves may not perform well.

Dry seeds properly and ensure that the moisture content is not more than 13 per cent.

Avoid excess drying in summer months especially for short duration varieties as it reduces the period of viability.

While drying and storing, avoid contamination from yards or through baskets or bags.

Seeds may be stored in damp-proof situations for avoiding absorption of moisture from atmosphere thereby losing viability early.

Polythene bags of 700 gauge or double gunny bags may be preferred for storing.

Polythene bags of 400 gauge density may be preferred for storing paddy seeds dried to 10 per cent moisture content or less.

Never stack seed bags in open floors. Store on pallets or wooden benches. The benches should be 30 cm away from wall and floor for proper aeration.

Never pile more than eight bags in a stack. This should be limited to three bags if the seeds require further drying.

Avoid storing plant protection chemicals, herbicides, fertilizers etc. in seed store.

Fill up the cracks and crevices of storeroom by cementing to make it rat proof.

Spray 2 per cent malathion solution in the godown before storing seeds to check insect pests.

Place pieces of cloth dipped in neem oil between stacked bags or neem oil cake covered in cloth bags inside seed bags to ward-off pests.

Test seed germination at monthly intervals if the seeds are to be stored for more than eight months.

The viability of short duration varieties can be extended for a further period of 2-3 months at 80 per cent level if the seeds are soaked for four hours in water and re-dried in shade, back to original weight at 13 per cent moisture content. Seeds of short duration varieties like Jyothi and Triveni of virippu crop reach this level of germination 9-10 months after harvest and that of mundakan 8-9 months after harvest when stored under ambient conditions.

To keep sprouted pokkali seeds viable for two weeks, the seeds are to be kept in baskets made of plaited coconut leaves lined with koova, banana, karingotta or teak leaves.

#### Seed rate

Transplanting	60-85 kg ha <sup>-1</sup>
Broadcasting	80-100 kg ha <sup>-1</sup>
Dibbling	80-90 kg ha <sup>-1</sup>

The above seed rates are specified for farmers' field on the basis of minimum germination of 80 per cent. In pokkali cultivation, for Vyttila varieties, 100 kg ha<sup>-1</sup> may be sown on the beds or mounds formed in the field.

Seed rate may be enhanced from 80-100 kg ha<sup>-1</sup> to 125 kg ha<sup>-1</sup> for Kuttanad, provided excess plants are removed in order to maintain optimum plant population.

#### Seed treatment

##### Dry seed treatment

Dress seeds with *P. fluorescens* @ 10 g/kg of seeds before sowing or with the following fungicides on the previous day of sowing (12 to 16 hours ahead) at dosage given below:

Carbendazim 2g per kg of seed

##### Wet seed treatment

Soak seed for 12 to 16 hours in a solution of *P. fluorescens* @ 10 g/litre of water per kg of seed or Carbendazim 2 g/kg of seed per litre of water and drain to induce germination.

Treatment with Carbendazim will protect the seedlings from blast disease up to 30 to 60 days after sowing.

The above seed treatment can also be used for protection from seedling blast in endemic areas.

Soak paddy seeds in CuSO<sub>4</sub> (0.25 per cent) and ZnSO<sub>4</sub> (1 per cent) solution for

24 hours. Drain and keep for sprouting. For soaking 1 kg of seed, 1 litre of micronutrient solution would be needed.

#### Nursery

For transplanting, healthy seedlings have to be raised in seedbed. Healthy seedlings can cope up better with the field conditions that affect the growth of young rice plants. Adopt wet or dry method for raising seedlings. The choice depends primarily on the availability of water.

##### Wet method

The wet method can be adopted in areas where water is available as in the second crop season. Seedlings raised by the wet bed method can be harvested one week earlier. The seedbed should be prepared in advance, so that the pre-germinated seeds can be sown in time. As far as possible, fertile lands with irrigation and drainage facilities should be selected for raising the nurseries. Such lands should be suitably located to receive full sunlight. The following are the steps in raising wet nursery.

Plough and harrow the fields two or three times until the soil is thoroughly puddled and levelled. Prepare raised beds 5 to 10 cm height 1 to 1.5 m width and of convenient length with drainage channels between the beds. The total seedbed area should be 1000 m<sup>2</sup> for each hectare of the field to be transplanted.

Apply compost or cattle manure @ 1.0 kgm<sup>-2</sup> of the nursery bed and mix well with the soil at the time of preparation of the field.

Treat the seeds by wet method. Drain and incubate in warm moist place for sprouting. Never allow the seeds to dry up. Moisten them occasionally. Sow germinated seeds on the third day. Delay will result in poor seedling stand.

Irrigation may be commenced on the 5<sup>th</sup> day after sowing and continued up to the 7<sup>th</sup> day, to a depth of about 5 cm. After this period, irrigate the seedbed continuously to a depth of about 5 cm in order to control weeds.

Drain occasionally to encourage production of vigorous seedlings with short roots. Flooding the soil with too much water for long periods produces tall and weak seedlings, which do not readily recover during transplanting.

If symptoms of nitrogen deficiency are observed, broadcast urea @ 1 kg for 100 m<sup>2</sup> as top dressing about 10 days prior to pulling out of seedlings, depending upon the duration of variety.

#### Dry method

This method is practised in areas where sufficient water is not available and the time of planting is uncertain. During first crop season, wherever transplanting is done depending upon receipt of rainfall, it is safer to adopt this method since growth of the seedlings can be controlled.

Plough the nursery area to a fine tilth. Prepare raised beds of 1 to 1.5 m width, 15 cm in height and of convenient length. Apply compost or cattle manure at the rate of 1 kg/m<sup>2</sup> of the nursery bed and mix well with the soil at the time of preparation of the field.

Sow the seeds treated as described under dry seed treatment method evenly over the bed and cover with fine sand or soil.

Water the nursery as and when required depending upon the receipt of rains.

Note: Rice seedlings from solarised nursery beds show high initial growth, early maturity and resistance to leaf blast disease.

#### Age of seedlings

Seedlings are ready to be pulled out when they attain the stage of 4-5 leaves, about 18

days after sowing in the case of short duration varieties and 20-25 days after sowing in the case of medium duration varieties. Under ill drained conditions, long duration varieties may be planted 30 days after sowing. Seedlings more than 30 days old when transplanted in the field recover slower than younger seedlings, especially, if they suffer stem and root injury. However, during the virippu season, age of seedlings can go up to 35 days in case of medium duration varieties and 25 days for short duration varieties. If the seedlings are over aged, plant at a closer spacing with 3 or 4 seedlings per hill and apply extra dose of nitrogen @ 5 kg/ha as basal dressing.

Irrigate seed beds a day before pulling out the seedlings to soften the soil and to facilitate washing of roots. Wash off mud and soil from the roots carefully and tie the seedlings into bundles of convenient size for transplanting.

Pruning of the top portion and root is not recommended as it inflicts wounds through which disease causing organisms may subsequently enter.

#### Preparation of land

##### General

Plough the field thoroughly to incorporate the weeds and straw into the soil. Ensure a smooth, level field for transplanting the seedlings. It would be better to transplant 10-15 days after incorporating organic manure. Before transplanting or sowing, apply manures and fertilizers at the rates specified for the region and varieties as indicated in Table 4. Apply fertilizers on the drained soil at the time of final ploughing and levelling and thoroughly mix into the soil.

##### Kuttanad

Drain out standing water from the main field. Plough the field thoroughly to incorporate the weeds in the field. Ensure a smooth and

Table 4. Fertilizer recommendation for rice, kg ha<sup>-1</sup>

Kind of land / region	Variety	N	P <sub>2</sub> O <sub>5</sub>	K <sub>2</sub> O
Uplands (modan)	Upland local varieties	40	20	30
-do-	High yielding short duration varieties	60	30	30
Wetlands (All regions)	-do-	70	35	35
-do-	High yielding medium duration varieties	90	45	45
-do-	Local varieties	40	20	20
-do-	H4	70	45	45
-do-	Mahsuri	50	25	25
Kole lands	*Short duration varieties	90	35	45
	*Medium duration high yielding varieties	110	45	45
Kattukampal and Ponnani kole lands	*Medium duration high yielding varieties	110	45	55
Wetland (Kuttanad)**	Medium duration high yielding varieties	90	45	15
Onattukkara	Dhanya	60	30	30
Koottumundakan	Photo in sensitive varieties for first crop	40	20	20
	Photosensitive varieties for second crop	20	10	10

\* Location specific recommendations. Strict surveillance of pests and diseases is a must under such situations.

\*\* Wherever the soil K status is medium to high based on soil test data and also where incorporation of straw is a practice and tidal contribution of the nutrient is significant. Phosphorus can be skipped for six seasons without any significant reduction in grain yield in riverine alluvium soils medium to high in available P.

levelled field. Maintain a thin film of water to facilitate sowing so that the germinated seeds do not get covered with clayey soil, which affects seedling establishment.

In Kari soils, avoid cracking of soils by prolonged drying since it will lead to severe acidity. Provide surface drains of 20 cm width and depth within the field at 10-20 m interval or running diagonally (kachals) and join them with surface drain of 30 cm width and depth taken along the perimeter of the field (vachals).

#### Kole

For the first crop in Kole, after the cessation of the heavy monsoon, dewatering is effected by petti and para or centrifugal pump and rarely by chakkram. Land is ploughed thoroughly and transplanting is done.

For the second crop, land is prepared thoroughly and direct sowing of sprouted seeds or transplanting is done.

#### Onattukkara

With the onset of pre-monsoon showers, land is ploughed thoroughly. Dibbling of



unsprouted seeds behind the country plough is the common practice.

#### Pokkali and Kaipad

By April, the bunds are being strengthened and sluices repaired for regulating water level. Fields are then drained during low tide and the sluices are closed. When the soil in the field becomes dry, mounds of 1 m base and 0.5 m height are formed. This facilitates the washing down of the dissolved salts from the surface of the mounds with the onset of monsoon, which are ultimately removed from the field by tidal action. The mounds act as elevated in situ nursery and protect the seedlings from flash floods.

A special method is adopted for sprouting the seeds. The seeds are tightly packed in baskets made of plaited coconut leaves, the inside of which is lined by banana or teak leaves. These baskets are then immersed in fresh water ponds for 12 to 15 hours. They are then taken out and stored in shade. The radicle just sprouts and remains quiescent under this condition for more than 30 days. When the soil and weather conditions become favourable for sowing, the baskets containing the seeds are re-soaked for 3 to 6 hours before sowing. The mounds in the field are then raked and top levelled. The sprouted seeds are sown on the top of mounds, which act as an in situ nursery. When the seedlings reach

a height of 40-45 cm (in 30-35 days), the mounds are cut into pieces with a few seedlings, which are uniformly spread in the field.

#### Koottumundakan

In this system of rice cultivation, a mixture of seeds of a non-photosensitive (virippu) variety and a photosensitive (mundakan) variety of rice in the proportion 70:30 (w/w) is sown during virippu season. This system is practiced in areas where sowing / planting of mundakan crop is not possible due to excess water in the field. Hence, mixture of the two varieties is sown in the first crop season (April-May). The first crop variety will be ready for harvest in August-September and the second crop variety can be harvested in December-January. No cultivation is practised after the harvest of first crop season variety. But both organic and inorganic manures are applied and incorporated. Though the yield will be less than that of the two independent crops, this type of cultivation is taken up in view of the special circumstances prevailing in such areas.

#### Transplanting

Transplant seedlings of appropriate age for the variety @ 2-3 seedlings per hill in rows, at spacing as shown in Table 5. Leave wider row of 30 cm after every 3 m to facilitate spraying and other cultural operations. Transplant seedlings at a depth of 3-4 cm.

Table 5. Spacing for rice transplantation

Season	Duration	Spacing	No. of hills/m <sup>2</sup>
First crop	Medium	20 cm x 15 cm	33
	Short	15 cm x 10 cm	67
Second crop	Medium	20 cm x 10 cm	50
	Short	15 cm x 10 cm	67
Third crop	Medium	20 cm x 10 cm	50
	Short	15 cm x 10 cm	67

Wet seeding by seed drums and weed control by cono weeder

- Drum seeding and cono weeding can be safely adopted.
- It is suitable for areas where efficient water management is possible (especially during rabi) and during kharif in areas where torrential rains are absent.
- For short duration varieties 15cm spaced and for medium duration varieties 20cm spaced seed drum is recommended.
- SRI (System of Rice Intensification) is a method of rice cultivation introduced by French priest Fr: Henry D Laulanie in 1983 in Madagascar and the technology was spread in other countries by Dr. Norman Uphoff of Cornell University, USA. (Principles of SRI given as Annexure XV).

Manuring

Organic manuring

Apply organic manure in the form of farmyard manure or compost or green leaf @ 5 t ha<sup>-1</sup> and incorporate into the soil while ploughing. Vermicompost or coirpith compost @ 2.5 t ha<sup>-1</sup> can be substituted for 5 t ha<sup>-1</sup> FYM in Onattukara region. The entire quantity of phosphatic fertilizers may be applied along with the organic manures.

Use of biofertilizers is recommended (See chapter on biofertilizers).

Green crop manuring

Cowpea may be raised as an intercrop in dry seeded low land (semi-dry) rice by sowing 12.5 kg/ha seed along with rice to serve as a source of green manure. When the rice field gets submerged with the onset of south west monsoon, cowpea at the age of about six weeks and at active vegetative stage decays and gets self-incorporated in the soil adding substantial quantity of green manure. Such a system of concurrent growing of cowpea also reduces weed pressure in semi-dry rice.

Concurrent growing of cowpea/daincha

A. Dry seeded rice

When there is an undue delay in the onset of monsoon, concurrently grown cowpea in rice fields can be incorporated by spraying 2,4-D @ 1.0 kg ha<sup>-1</sup> at 30-40 days after sowing without affecting the yield with a substantial reduction on weed incidence.

B. Wet seeded rice

In wet seeded rice, daincha can be raised as an intercrop by sowing 20 kg seed of daincha ha<sup>-1</sup> along with rice (seed rate 60 kg ha<sup>-1</sup>) to serve as a source of green manure. Daincha can be incorporated by spraying 2, 4-D @ 1.0 kg ha<sup>-1</sup> at 30 days after sowing thereby adding substantial quantity of green manure. System of concurrent growing of daincha can also reduce the weed pressure in wet seeded rice.

Fertilizer application

The rates of N, P<sub>2</sub>O<sub>5</sub> and K<sub>2</sub>O recommended as fertilizers are given in Table 4 and stages of application in Table 6.

For modan cultivation (upland crop) and direct seeded crop in wet lands, apply nitrogen in three equal split doses, first as basal dressing, second at tillering stage (three weeks after seeding) and the third at panicle initiation stage (about thirty days before flowering). Apply the full dose of phosphorus at the time of land preparation as basal dressing. Apply potash either in a single dose as basal or in two split doses half as basal and half at the panicle initiation stage.

In Kuttanad region, wherever wet broadcasting (direct seeding) is adopted, give the first basal application of the nitrogen at the time of letting in water after drying the field. Water-soluble phosphorus can be recommended for application in two split doses

Table 6. Stages of fertilizer application in rice

Kind of land/ region	Variety	Stages of Application									Remarks
		N			P			K			
		BA **	AT	API	BA	AT	API	BA **	AT	API	
Uplands	PTB 28, 29,30	1/3	1/3	1/3	Full			1/2*		1/2	**For direct seeded crop, one week after sowing * Full dose as basal is also recommended
	HY short duration	1/3	1/3	1/3	Full			1/2*		1/2	* Full dose as basal is also recommended
Wet land, direct seeded	General	1/3*	1/3	1/3	Full			1/2*		1/2	*For wet seeded, the first dose to be given 1 week after sowing. For dry seeded, first application to be given after establishment of the seedlings
Wet land, transplanted	Mahsuri	1/3	1/3*	1/3**	Full			1/2		1/2**	*45 DAS, **85 DAS
	HY short duration	2/3		1/3*	Full			1/2		1/2	*5-7 days before PI
	HY, medium duration	1/2		1/2*	Full			1/2		1/2*	*5-7 days before PI
	Mahsuri	1/2	1/4*	1/4**	Full			1/2		1/2**	*40 DAP, ** 60 DAP
Onattukara	General	1/2	1/4	1/4	Full			1/2		1/2	In very coarse soils, N & K may be given in five equal splits
Wayanad and hilly region	Long duration transplanted		1/2	1/2		Full*		1/2	1/2		*Along with first application of N & K
Koottumundakan	Direct seeded		1/2*	1/2		Full**		1/2*	1/2		*45 days after seeding, **With first application of N & K
	First crop Second crop	1/2 Full*		1/2	Full Full*			1/2 Full*		1/2	*Entire quantity as single dose immediately after the harvest of first crop

BA=Basal application; AT =At tillering; PI =At panicle initiation; HY = High yielding; DAP = Days after planting; DAS = Days after seeding

in Kuttanad region, as basal and at maximum tillering stage.

The general principle to be followed is that in light soils as well as in soils with high leaching, nitrogen may be applied in three or four split doses according to the duration of the variety.

For typical Onattukara region, where soil is sandy loam and with iron toxicity

problem, apply 5 tonnes of organic matter or vermicompost 2.5 t and 67.5 kg K<sub>2</sub>O ha<sup>-1</sup>.

During the first crop season, when basal application of nitrogen is not possible due to incessant rains, basal dose can be shifted to 15 days after transplanting.

In coarse sandy loam soils with high percolation as in Onattukara region, nitrogen and potash fertilizers may be applied in five

equal splits at planting, 15<sup>th</sup>, 38<sup>th</sup>, 53<sup>rd</sup> and 70<sup>th</sup> day for medium duration varieties which coincide with the stages of early tillering, neck node differentiation, early reduction division and heading stages respectively in the case of medium duration varieties.

For Thiruvananthapuram and Malappuram districts, phosphorus application is essential for increasing rice yields. Rock phosphate may be substituted for superphosphate.

Basal dose of nitrogen may be postponed to initial tillering phase of rice crop, especially during the rainy season. Split application of potash @ 50 per cent basal, 25 per cent at tillering and 25 per cent at panicle initiation stage is recommended for this region.

In sequential cropping of rice, application of 50 per cent of the nutrient requirement (on nitrogen equivalent basis) as organics (FYM, rice straw, green manure) and 50 per cent as fertilizers during kharif season and the entire dose of nutrients as fertilizers in rabi season enhances the grain and straw yield. The organics may be incorporated 3 weeks before transplanting.

Application of 25 per cent of the nutrient requirement as organics and 75 per cent as fertilizers during kharif season and reducing the fertilizer dose of rabi by 25 per cent gives comparable yield with full POP recommendation during both seasons.

#### Specific dose of fertilizer for Koottumundakan system

A fertilizer dose of N:P<sub>2</sub>O<sub>5</sub>:K<sub>2</sub>O 20:10:10 kg ha<sup>-1</sup> for the first crop and 30:15:15 kg ha<sup>-1</sup> for the second crop is recommended for high yield in Koottumundakan system. N and

K<sub>2</sub>O may be applied in two equal parts for the first crop, one as basal and other at panicle initiation stage. P<sub>2</sub>O<sub>5</sub> may be applied fully as basal. The fertilizer for second crop may be applied as a single dose immediately after the harvest of the first crop (ad hoc recommendation).

Fertilizers (N:P<sub>2</sub>O<sub>5</sub>:K<sub>2</sub>O) @ 40:20:20 kg ha<sup>-1</sup> for virippu and 20:10:10 kg ha<sup>-1</sup> for the photosensitive mundakan crop are recommended as economic dose for the northern region under Koottumundakan practice.

#### Methods of fertilizer application

For pre-planting application, apply the fertilizers at the final ploughing. In areas where availability of water is assured, temporarily draining the field one day prior to application and re-flooding after twelve hours is recommended for top dressing of fertilizer.

For increasing the efficiency of urea for top dressing, mix urea with six times its weight of slightly moist soil and apply to the field 24-28 hours after mixing. Oil seed cakes such as punna and neem cakes can also be mixed with urea (1 part of oil cake + 5 parts of urea by weight) for increasing fertilizer use efficiency. This method is particularly useful for basal application of nitrogen. Under special conditions of drought and water-logging, apply nitrogen as foliar spray. Urea may be applied as a low volume spray at 15 per cent concentration using power sprayer or at 5 per cent concentration using a high volume sprayer; the quantity applied in one application being limited to 15 kg ha<sup>-1</sup>.

When zinc deficiency is noticed, apply zinc sulphate @ 20 kg ha<sup>-1</sup>. Early stages of zinc

deficiency are evidenced by interveinal chlorosis, bleaching of midribs and light yellow colouration of the leaf. Older leaves develop brown rusty spots and are extremely brittle. Zinc sulphate and potash should not be applied on the same day.

In Kari soils of Kuttanad, apply Dolomite @ 450Kg/ha as two splits, half at the time of initial ploughing and half as top dressing one week prior to the application of fertilizers at the PI stage.

The effect of zinc application can persist upto five years depending on the soil and cropping pattern. Hence soil application is not required for every season. Soil zinc status should be monitored before application to avoid accumulating toxic concentration of zinc.

Split application of water-soluble phosphatic fertilizers in two equal splits as basal and at maximum tillering stage is effective in giving higher grain and straw yield than the full dose as basal dressing under certain situations.

When the soil has less than 10 ppm of calcium chloride extractable sulphur or 15 ppm of phosphate extractable sulphur, substitute urea with ammonium phosphate sulphate to correct sulphur deficiency. For medium duration rice grown in brown hydromorphic soils ammonium phosphate sulphate may be used to supply 25 kg sulphur per hectare to protect the crop from sulphur deficiency (ad hoc recommendations).

K status of soil is maintained by straw incorporation. After straw incorporation, if soil analysis prior to cropping season indicates low K status, K should be applied @ 15 kg  $K_2O$  ha<sup>-1</sup>.

Application of magnesium as basal dose in the form of magnesium sulphate (16 per cent MgO) or magnesite (40 per cent MgO) or dolomite (10 per cent MgO) @ 20 kg MgO/ha is effective in giving a significant increase in grain and straw yield of rice in magnesium deficient soils. In non-deficient soils, a marginal increase in grain and straw yield is also obtained. On per unit MgO basis, magnesite is more concentrated and cheaper than magnesium sulphate.

In iron toxic laterite soils of Kerala, application of 120 kg potash ha<sup>-1</sup> + lime 150 kg ha<sup>-1</sup> + silica 100 kg ha<sup>-1</sup> (as sodium silicate 250 kg ha<sup>-1</sup> or fine silica 100 kg ha<sup>-1</sup> or rice husk ash 500 kg ha<sup>-1</sup>) is recommended for higher yields.

#### Liming

In general, addition of lime is absolutely necessary when the pH is lower than 5.5 and it is advisable when pH varies between 5.5 and 6.5.

Apply lime @ 600 kg ha<sup>-1</sup> in two split doses, the first dose of 350 kg ha<sup>-1</sup> as basal dressing at the time of first ploughing and the second dose of 250 kg ha<sup>-1</sup> as top dressing about one month after sowing/transplanting.

A time lag of one week should be given between application of lime and fertilizers. For top dressing, lime may be applied one week prior to the application of fertilizers.

#### Water management

Maintain water level at about 1.5 cm during transplanting. Thereafter increase it gradually to about 5 cm until maximum tillering stage. Drain water 13 days before harvest.

Note: In areas where water for irrigation is assured and where acidity is high, draining and reflooding every 15 days is recommended. In flood prone areas, aged seedlings of Mahsuri or other varieties recommended for waterlogged conditions may be planted. The date of planting may be adjusted so as to avoid synchronization of the critical stages of maximum tillering or heading with the usual flood period in the tract.

During the mundakan crop season, water level of 5 cm need not be maintained continuously after the cessation of northeast monsoon. Five centimetre irrigation once in 6 days will be quite adequate for project areas where water is assured.

For summer rice (in situation where the ground water level is low, i.e., within 1m from the surface), 5 cm irrigation two days after disappearance of ponded water is sufficient instead of 5 cm continuous submergence throughout the crop period.

Irrigation schedule for rice under limited water resources

For summer rice under limited resources of water, phasic stress irrigation can be practised to the advantage of saving substantial quantity of irrigation water without any significant reduction in yield. About 20-30 per cent more area can be irrigated with the same water resources by adopting any of the following phasic stress irrigation schedules (Table 7). Depending up on the schedule, water saving ranges from 24-36 per cent of the requirement for 5 cm continuous submergence throughout the crop growth. Grain yield reduction in the above practice is only 0.1 per cent to 1.6 per cent.

Weeds and their management

Common weeds in rice fields of Kerala are:

Grasses: *Oryza rufipogon* (varinellu), *Echinochloa crusgalli* (kavada), *E. colona* (kavada), *E. stagnina* (kavada), *Sacciolepis interrupta* (polla), *Isachne miliacea* (chovverippullu, naringa).

Sedges: *Cyperus iria* (manjakora, chengool), *C. difformis* (thalekkattan), *Fimbristylis miliacea* (mungai).

Table 7. Irrigation schedule for rice under limited water resources

Schedule	Stages		
	Rooting to max. tillering	Max. tillering to heading	Heading to maturity
Category I	Continuous submergence	Saturation point*	Saturation point*
Category II	Saturation point*	Continuous submergence	Continuous submergence
Category III	Continuous submergence	Continuous submergence	Hair cracking of surface*
Category IV	Hair cracking of surface*	Continuous submergence	Hair cracking of surface*

\* Irrigation at 5 cm to be given at the stages marked.

Broad leaved weeds: *Monochoria vaginalis* (neelolppalam), *Ludwigia perennis* (neer-grampu), *Limnocharisflava* (nagappola), *Ammania baccifera* (nellicheera).

Ferns: *Salvinia molesta* (African payal), *Marsilea quadrifolia* (naalilakodian), *Azolla pinnata* (azola).

Algae: *Chara* spp. (chandi), *Spirogyra* spp. (payal).

Control

Keep the rice fields free from weeds up to 45 days either by hand weeding or by use of herbicides. The recommendation for use of herbicides in different systems of rice culture are given below:

### I. Pre emergence herbicides

#### A. Dry seeded rice [upland and lowland (semi-dry) rice]

Sl. No.	Herbicide	Dose Kg ai/ha	Time of application	Weeds controlled	Remarks
1.	Butachlor	1.25	0 - 6 DAS	Pre emergence control of all types of weeds for 3 - 4 weeks.	Give a follow up hand weeding at 30 DAS or apply a post emergence herbicide, if needed, to control later emerging weeds.
2.	Pretilachlor	0.75	0 - 6 DAS		
3.	Oxyfluorfen	0.15	0 - 6 DAS		
4.	Pendimethalin	1.50	0 - 6 DAS		
5.	Pretilachlor + Bensulfuron methyl	0.6 +0.06	0 - 6 DAS		

#### B. Wet seeded rice (Direct seeding with sprouted seeds under puddled conditions)

Sl. No.	Herbicide	Dose Kg ai/ha	Time of application	Weeds controlled	Remarks
1.	Butachlor	1.25	6 - 9 DAS	Pre emergence control of all types of weeds for 3 - 4 weeks.	Give a follow up hand weeding at 30 DAS or apply a post emergence herbicide, if needed, to control later emerging weeds. Drain the field before herbicide application. Some phytotoxicity to rice seedlings likely.
2.	Pretilachlor	0.75	6 - 9 DAS		
3.	Oxyfluorfen	0.15	6 - 9 DAS		
4.	Pretilachlor + safener (sofit)	0.45	3 - 5 DAS		
5.	Pretilachlor + Bensulfuron methyl	0.6 +0.06	6 - 9 DAS		
6.	Pyrazosulfuron ethyl	0.02 - 0.03	6 - 9 DAS		

## C. Transplanted rice

Sl. No.	Herbicide	Dose Kg ai/ha	Time of application	Weeds controlled	Remarks
1.	Butachlor	1.25	0 - 6 DAT	Pre emergence control of all types of weeds for 3 - 4 weeks.	Give a follow up hand weeding at 30 DAT or apply a post emergence herbicide, if needed, to control later emerging weeds.  Maintain standing water in the field for good results.
2.	Pretilachlor	0.75	0 - 6 DAT		
3.	Pretilachlor + Bensulfuron methyl	0.6 + 0.06	0 - 6 DAT		
4.	Pyrazosulfuron ethyl	0.02 - 0.03	0 - 6 DAT		
II. Post emergence herbicides					
i. Dicot weeds					
Sl. No.	Herbicide	Dose (kg ai/ha)	Time of application	Weeds controlled	Remarks
1.	2, 4-D	0.80	20 - 25 DAS/DAT	Broad leaved weeds and sedges.	Grass weeds not controlled.
2.	Chlorimuron ethyl + Metsulfuron methyl	0.004	20 - 25 DAS/DAT	Broad leaved weeds and sedges. Control Marsilea quadrifolia and Sphehoclea spp. also.	With 0.2 % surfactant.
3.	Carfentrazone	0.02	20 - 25 DAS/DAT	Broad leaved weeds and sedges.	Very effective against Melochia corchorifolia.
4.	Ethoxysulfuron	0.015	20 DAS	Broad leaved weeds and sedges.	
ii. Grass weeds					
1.	Cyhalofop butyl	0.08	15 - 18 DAS/DAT	Control grass weeds like Echinochloa spp., Sacciolepis spp., Leptochloa chinensis	Broad leaved weeds and sedges not controlled.
2.	Fenoxapropethyl	0.06	15 - 18 DAS/DAT	-Do-	-Do-



## iii. Broad spectrum

Sl. No.	Herbicides	Dose (Kg a.i/ha)	Time of application	Weeds controlled	Remarks
1.	Azimsulfuron	0.035 DAS/DAT	15 - 20	All types of weeds.	Only partial control of <i>Leptochloa chinensis</i>
2.	Penoxsulam	0.025 DAS/DAT	15 - 20	All types of weeds.	Only partial control of <i>Leptochloa chinensis</i>
3.	Bispyribac	0.025 sodium	15 - 20	All types of weeds DAS/DAT except <i>Leptochloa chinensis</i> .	Not effective against <i>Leptochloa chinensis</i>

1. Weed free seeds : Use seeds from weedy rice free areas.

2. Stale seed bed technique:

After land preparation, withhold sowing and allow the weedy rice seeds in the top layers of the soil to germinate. After two weeks, when most of the seeds would have germinated, destroy the germinated seedlings by ploughing the field or by spraying non selective herbicides like glyphosate or glufosinate ammonium @ 8 ml product/litre of water. If time permits repeat the process once again. When the seedlings starts yellowing 4-5 days after herbicide application, let in water and flood the field to allow complete kill of the emerged seedlings.

Drain the field after 10 days of flooding and broadcast the germinated rice seeds, without further ploughing. In fields with very severe infestation, skip the crop for one season and go for repeated stale seed bed operations to exhaust the soil seed bank of weedy rice.

3. Pre sowing herbicide application to prevent the establishment of weedy rice seedlings

After land preparation, drain the field to retain only a thin film of water. Apply oxyfluorfen @ 0.2 kg ai/ha either by spraying

or sprinkling with a rose can or broadcasting after mixing with sand. Allow the water in the field to evaporate. After three to four days, when the standing water has evaporated, broadcast pre germinated rice seeds. The herbicide applied will prevent the emergence of weeds (including weedy rice) for about two weeks. Most of the rice seeds sown above this layer can germinate.

4. Direct contact application of herbicides to kill the earheads

Weedy rice produce earheads about 10-15 days ahead of rice. The quick growth just before flowering, results in about 15-30 cm height difference between rice and weedy rice. Utilizing this, non selective herbicides like glyphosate or glufosinate ammonium can be applied directly on to the earheads of weedy rice, using the KAU Weed Wiper specially designed for this purpose. Mix 100 ml of the herbicide (formulation of glyphosate or glufosinate ammonium) in one litre of water. Care should be taken not to apply the herbicide on the leaves of rice. The earheads of weedy rice will dry within 5 days.

Above methods should be used alone or in combination depending on the severity of infestation of weedy rice.

#### Management of *Salvinia molesta* (African payal)

Trampling *salvinia* in situ in the wet lands a week before transplanting will control the weed and add to soil fertility. Herbicides should be applied only in areas where protected drinking water supply is available

#### Precaution while using herbicides

(1) Apply herbicides at the recommended dose and time. (2) Drain the field before herbicide application. (3) Re-flood after 48 hours to prevent further weed germination when post emergent herbicides are used. For pre-emergent herbicides, wait for a week before re-flooding the field. (4) Use herbicide nozzle (flood jet / flat fan) for herbicide application. (5) Move at uniform speed when applying herbicides. (6) Spray without gaps and overlapping. (7) Use 300-400 litres of water per hectare for spraying the herbicide.

#### Pests and Diseases

Adopt control measures only if the pest / disease population exceeds the economic threshold levels which are given in Table 8. A general guide for rice pest control is given as Table 10.

#### Pests

##### Rice stem borer

(*Scirpophaga incertulas*)

#### Symptoms

In the vegetative phase, the central shoot dies off turning yellow in colour (dead heart). In the ear bearing stage, the ear head appears completely chaffy and white in colour (white ear head). Both come out easily when pulled up and show indication of feeding injuries at the base.

#### Management

1. Collect egg masses from the nursery plants and observe for parasitisation.
2. Cultivate tolerant/resistant varieties in endemic areas.
3. In areas where stem borer occurs as a serious pest in all seasons, apply any one of the following insecticides first 15-20 days after transplantation and then at the boot leaf stage keeping minimum water level: Cartap hydrochloride, Quinalphos, Carbosulfan, Fipronil, Chlorantraniliprole, Flubendiamide, Indoxacarb, Malathion or Spinosad.

For eco friendly management of rice stem borer the following practices can be adopted.

4. Use sex pheromone for the control of rice stem borer as detailed in Table 9.
5. *Bacillus thuringiensis* @ 200g/ha, fish jaggery extract @ 6ml/l, Chitin based *Pseudomonas* @ 2.5kg/ha, *Trichogramma japonicum* and *T. chilonis* each @ 1 lakh/ha + *Beauveria bassiana* @ 10 gm/l, Azadirachtin 1% @ 750ml/ha.

#### Gall midge (*Orseolia oryzae*)

#### Symptoms

Presence of silver shoot is the symptom. The symptom appears from the nursery to the flowering stage. However, in very young seedling the silver shoots are not always expressed. Instead, a swelling at the basal portion and excess tillering are noticed.

#### Management

1. Use tolerant varieties like Pavithra, Panchami and Uma.
2. Avoid late transplantation during the first crop season.
3. Careful monitoring of the crop seasons in the month of July during additional crop season and October during pancha season.

Table 8. Economic threshold levels (ETLs)

Crop stage and pest	Economic threshold levels
A. Nursery	
1. Green leaf hopper	1-2 insects/m <sup>2</sup>
2. Gall midge	1 silver shoot (gall)/ m <sup>2</sup>
3. Stem borer	1 moth or 1 egg mass/ m <sup>2</sup>
4. Blast	5% disease severity
B. Planting to pre-tillering	
1. Leaf folder	2 freshly damaged leaves/hill
2. Yellow stem borer	10% dead hearts or one egg mass or one moth / m <sup>2</sup>
3. Gall midge	1 gall/m <sup>2</sup> in endemic areas or 5% affected tillers in non-endemic areas.
4. Brown plant hopper	5 to 10 insects/hill
5. Green leaf hopper	10 insects/hill (in RTV endemic areas 21 insects/hill)
6. White backed plant hopper	10 insects/hill
7. Rice Hispa	2 adults or 2 damaged leaves/hill
C. Mid tillering	
1. Leaf folder	2 freshly damaged leaves/hill
2. Stem borer	10% dead heart or 1 moth or 1 egg mass/ m <sup>2</sup>
3. Gall midge	10% silver shoots
4. Brown plant hopper	10 insects/hill
5. Green leaf hopper	10-20 insects/hill
6. Hispa	2 adults or 2 damaged leaves/hill
7. Blast	Light (5-10% disease severity)
8. Bacterial blight	Light (2-5% disease severity)
9. Sheath blight	10% or more affected tillers
10. Tungro	1 affected hill/ m <sup>2</sup>
D. Panicle initiation to booting	
1. Stem borer	1 egg mass or 1 moth/ m <sup>2</sup>
2. Leaf folder	2 freshly damaged leaves/hill
3. Green leaf hopper	20 insects/hill
4. Brown plant hopper	15 to 20 insects/hill
5. White backed plant hopper	15 to 20 insects/hill
6. Blast	5 to 10% leaf area damaged
7. Bacterial blight	Light to moderate (2-5% disease severity)
8. Sheath blight	10% or more tillers affected
E. Flowering and after	
1. Brown plant hopper	25 to 30 insects/hill
2. Climbing cutworm	4-5 larvae/m <sup>2</sup>
3. Rice bug	1 or 2 bugs/hill
4. Blast	5% leaf area damaged or 1-2% neck infection
5. Sheath rot / brown spot / slight panicle discolouration	2-5% tillers affected
6. Sheath blight	10% or more tillers affected
7. Stem borer	2% white ear head

Source : Manual on Integrated Pest Management in Rice, Directorate of Plant Protection, Quarantine and Storage

Note: (1) The population should be estimated on the basis of careful and regular surveillance.

(2) When natural enemies of brown plant hopper, green leaf hopper, stem borers and leaf folders are present, application of chemicals can be delayed or dispensed with.

4. Use optimum seed rate of 100 kg ha<sup>-1</sup>
5. Destruction of collateral host like wild rice, *Cynodon dactylon*, *Ischaemum aristatum*, *Echinochloa* spp. and *Isachne* sp.
6. Dipping germinated seed in 0.2 per cent chlorpyrifos solution for 3 h before sowing.
7. In transplanted crop root dip seedlings in 0.02 per cent chlorpyrifos suspension for 12 h prior to planting.
8. Nursery treatment has to be followed by main field treatment, 10-15 days after transplantation using carbosulfan 6 G/ Chlorantraniliprole 0.4 G/Fipronil 0.3 G.
9. In areas where the pest is of regular occurrence, apply chlorpyrifos 10G (0.5 kg ai/ha) within 10 days after sowing. The granules should be broadcast in 2-3 cm of water and the field should be impounded for at least 4 days.

Table 9. Sex pheromone used for the control of rice yellow stem borer

Chemical name of the pheromone	2-(z)-9-hexadecanol 2-(z)-11-hexadecemol in 1:3 identified from female moths
Sex attracted	Male moths
Description of the trap Uses	Sleeve trap with pheromone loaded rubber septa Pest monitoring : Three traps can be fixed in a triangular fashion at about 80 m apart Mating confusion
Number of traps required/ha	Twenty
Sources of availability	Entomology Department, Directorate of Rice Research, Rajendra Nagar, Hyderabad.
	Pest Control India limited, Bio-control Research Laboratories P.O. Box. 6426, Yelahanka P.O., Bengaluru-560 064 Kamataka
	Ecomax Agrosystems 302, Faigha Plaza Basher Bagh, Hyderabad.
	Dr. David Hall and Dr. Allen Cork, Natural Resources Institute, Kent ME4, 4TB, United Kingdom.
	The Managing Director, Som IPM System (India) Ltd, Plot No. 101, 1 Floor, Srinagar Colony, Hyderabad.

#### Rice bug (*Leptocorisa acuta*)

##### Symptoms

Look for the presence of bug in the field during the early ear bearing stage. Due to desapping, grains show brownish discoloured patches on the husk.

##### Management

1. Strict vigilance is necessary at milky stage.
2. Keep the field and bunds free of weeds and grasses.

3. Avoid overlapping cultivation in an Ela.
4. When the bug is seen in large numbers apply Malathion.

Note: Since the occurrence of the bug coincides with the flowering stage, application of the insecticide may be done either before 9 a.m. or after 3 p.m. so that fertilization of the flowers is not adversely affected.

For eco friendly management of Rice bug the following practice can be adopted.

Fish jaggery extract @ 6ml/l, Chitin based  
Pseudomonas fluorescens @ 2.5kg/ha

Leaf folder (*Cnaphalocrocis medinalis*)

Symptoms

The leaves of the plant are seen folded, rolled and often webbed together with white patches on them indicating the areas fed by caterpillar. When such folded leaves are opened up, larvae can be seen. Shaded conditions and application of excess nitrogen are conducive for leaf folder attack.

Management

1. Open up the leaf folds with the help of a thorny twig.
2. Apply one of the following insecticides in the field where the symptoms of attack are manifested: quinalphos, phosalone, acephate, flubendiamide, cartap hydrochloride, indoxacarb, carbosulfan 6 G, Chlorantraniliprole 0.4 G and dichlorvos.

Note: In the initial stages restrict spraying to infested patches only. The field may be sprayed completely in case the infestation occurs uniformly.

For eco friendly management of Rice Leaf folder the following practices can be practised.

1. Trichogramma japonicum and T. chilonis each @ 1 lakh/ha + Beauveria bassiana @ 10 gm/l
2. Chitin based Pseudomonas @ 2.5kg/ha, Bacillus thuringiensis @ 200g/ha, Fish jaggery extract @ 6ml/l, Azadirachtin 1% @ 750 ml/ha

Brown plant hopper (*Nilaparvata lugens*)

Symptoms

Yellowish circular patches appear here and there in field. The plants in these areas dry up

very soon (hopper burn) and the yellowing and drying extend rapidly. Examine the plants as soon as the yellowing appears. Presence of the hoppers at the base of the plants confirms the infestation. Very close planting leads to enhanced attack.

Management

1. Use tolerant varieties for cultivation.
2. Apply one of the following insecticides as soon as the yellowing symptom is observed, covering the infested patches and the areas surrounding the patches: quinalphos, acephate, thiamethoxam, phosalone, buprofezin, ethofenprox and imidacloprid. While spraying, care has to be taken to see that the insecticides reach the base of the plants.
3. Drain away water from the field and keep it in that conditions until the pest population dwindle.
4. In Kuttanad tract, early planting of paddy in September-October is advisable, wherever possible.
5. Allow alleways after every 3m rows.
6. Avoid spraying synthetic pyrethroids.

Rice case worm (*Nymphula depunctalis*)

Symptoms

Leaves of plants are eaten by the caterpillars, which remain within small cylindrical cases and are seen hanging on the leaves. It occurs in ill drained fields. The cases may be seen floating on water also.

Management

Drain away the water from the fields.

For eco friendly management of Rice Case worm the following can be practised.

Chitin based Pseudomonas @ 2.5kg/ha<sup>1</sup>, Azadirachtin 1% @ 750 ml/ha<sup>1</sup>

Rice swarming caterpillar  
(*Spodoptera mauritia*)

Symptoms

It appears in the field sporadically and cyclically in large swarms and feed on crops gregariously. The nursery and early stages of the crop are attacked leaving the plant as mere stumps.

Management

Flood the field as soon as the caterpillars are noticed.

Rice hispa (*Dicladispa armigera*)

Symptoms

The adults feed on the green tissues of the leaves and the feeding scars appear as short white lines on the leaf surface. The grubs mine the leaves causing formation of white blotches. Early stages of the crop are more susceptible.

Rice thrips (*Stenchaetothrips biformis*)

Symptoms

The crop is highly susceptible in the nursery stage for the first 23-25 days after transplanting/sowing. The tips of leaves get rolled longitudinally into needle like outgrowths and turn whitish. In severe cases, the lower leaves also turn yellowish. The infestation may be rated as mild, if there is less than three needle like leaves and as severe, if there are more than three outgrowths with the lower leaves also showing chlorosis and scorching.

Management

In severe infestations, apply DDVP 100 per cent EC/AF 250 ml/ha or dimethoate or quinalphos or phenthoate (EC/AF formulation).

Whorl maggots (*Hydrellia philippina*)

Infestation is common in the nurseries and in the main fields up to six weeks after transplantation. Yellowish patches and streaks

are seen along the margins of leaves, which may become deformed.

Leaf hoppers (*Nephotettix* spp.)

Symptoms

General yellowing of the leaves is seen, if the attack is severe. When the plants are disturbed, the jassids are seen jumping out.

Management

Apply quinalphos, imidacloprid if needed.

Rice mealy bug (*Brevinnia rehi*)

Symptoms

Weak yellowish stunted plants are seen in patches. White waxy fluff is seen in leaf sheaths.

Management

Dimethoate 0.05 per cent is effective in controlling the pest.

Rice root nematode (*Hirschmanniella oryzae*)

Symptoms

Infests paddy roots and make them partially hollow. Feeding adversely affects absorption of water and nutrients. Plants show stunted growth in patches. Tiller production is affected.

Management

Dip the roots of seedlings in 0.2 per cent dimethoate for six hours before transplanting in tracts where nematode attack is detected.

Rice cyst nematode  
(*Heterodera oryzae*)

The cyst nematode occurs in various proportions in certain areas of the State. The symptoms of infestation include leaf chlorosis, stunting and reduction in the number of leaves, earhead length etc. In seriously affected patches, yield is substantially reduced.

Table 10. Insecticide guide for rice pest control

Sl. No.	Insecticide	*Dosage	Insect controlled
1	2	3	4
1.	Acephate	800 g of 75 SP per ha	Rice leaf folder, Brown plant hopper
2.	Carbosulfan	17 kg of 6 G per ha	Rice stem borer; Gall midge and leaf folder
3.	Cartap hydrochloride	25 kg of 4 G per ha	Rice stem borer and leaf folder.
4.	Cartap hydrochloride	1kg of 50 SP per ha	Rice stem borer and leaf folder.
5.	Chlorpyrifos	0.2% suspension	Germinated seed dip for 3 hrs. against gall midge
		0.02% suspension	Seedling root dip for 12 hrs. against gall midge
6.	Dichlorvos or DDVP	500 ml of 100 EC/AF per ha	Rice leaf folder; BPH, thrips
7.	Dimethoate	0.2% suspension	For seedling dip against rice nematode
		0.05% suspension	For foliar application against thrips
8.	Flubendiamide	125 g of 20 WDG per ha	Rice stem borer, whorl maggot and leaf folder
9.	Flubendiamide	50 ml of 480 SC per ha	Rice stem borer, whorl maggot and leaf folder
10.	Imidacloprid	150 ml of 200 SL per ha	Brown plant hopper
11.	Indoxacarb	200 ml of 15.8 EC per ha	Rice stem borer, whorl maggot, leaf folder and blue beetle.
12.	Malathion	1000 ml of 50 EC/AF per ha	Rice stem borer, whorl maggot and rice bug
13.	Phosalone	1000 ml of 35 EC/AF per ha	Brown plant hopper
14.	Quinalphos	1000 ml of 25 EC/AF per ha	Rice stem borer, brown plant hopper, gall midge, rice leaf folder and rice jassids
15.	Spinosad	100 ml of 45 SC per ha	Rice stem borer, whorl maggot and leaf folder
16.	Thiamethoxam	100 g of 25 WG per ha	Brown plant hopper
17.	Flubendiamide + Buprofezin 24% SC	210g a.i./ha (875ml/ha)	Rice stem borer, leaf folder and brown plant hopper
18.	Chlorantriliniprole 18.5 SC		150 ml /ha Rice stem borer, leaf folder and whorl maggot
19.	Chlorantranilprole 0.4G	10 kg/ha	Rice stem borer, gall midge and leaf folder

1	2	3	4
20.	Fipronil 0.3G	10 kg/ha	Rice gall midge
21.	Carbosulfan 6G	8 kg/ha	Rice stem borer, gall midge and leaf folder
22.	Buprofezin 20 SL	800 ml/ha	Brown Plant Hopper
23.	Ethofenprox 10% EC	750 ml/ha	Brown Plant Hopper

\* Dosage applies to the crop stage of booting and beyond. For early stages the quantity of insecticides can be reduced

SP = Soluble Powder; DP = Dustable Powder; G = Granule; EC = Emulsifiable Concentrate; AF = Aqua Flowable; WP = Wettable Powder; S = Sprayable suspension SL = Soluble Liquid SC = Suspension Concentrate; WDG = Water Dispersible Granule.

#### Note :

1. Sub-lethal concentration of insecticides may lead to pest resurgence.
2. Granular application is recommended only upto the booting stage.
3. Spot application method should be resorted to wherever possible
4. Use 200, 300 and 500 l/ha of spray fluid at 10, 25, 45 DAT or 30, 45, 60 DAS respectively for high volume spray equipment.
5. When low volume spray equipment is used the spray fluid can be limited to 90, 120, 180 l/ha, but the quantity of insecticide should remain the same as used in high volume spray 200, 300 and 500 l/ha respectively.
6. Waiting periods for quinalphos and malathion are 7 and 3 days respectively.
7. In regions where BPH is a regular pest avoid the application of the following insecticides due to the chances of resurgence to synthetic pyrethroids and quinalphos.

#### Diseases

A guide on control of rice diseases has been included as Table 11.

#### Fungal diseases

##### Blast (*Pyricularia grisea*)

Major symptoms of the disease are leaf blast and neck blast. Sometimes nodal infection is also seen.

Symptoms on leaves appear as spindle shaped water soaked greyish green spots, which gradually enlarge in size and develop to spots with grey centre and brown margin. Such spots coalesce together resulting in drying up of the leaves and collapse of the entire plant. The fungus infects the nodes of the stem and the neck of the panicle causing dark brown to black lesions resulting in rotten nodes and necks which subsequently result in node blast and neck blast respectively. This will also lead to breaking of the stem at the nodal region and the panicle at the neck region. The grains will be partially filled or unfilled. If the panicle is infected before grain filling stage, the entire panicle will be chaffy.



**Sheath blight (*Rhizoctonia solani*)**

Symptoms first appear on the lower leaf sheath near the water level as oval, oblong or irregular greenish grey spots, which enlarge and become greyish white with brown margin. Under favourable conditions, the disease spread to the leaves also. Irregular greenish grey lesions with dark brown margins develop on leaves. Under humid conditions, white mycelial growth of the fungus as well as initially white and later brown sclerotia of the fungus loosely attached to the affected portion are also seen.

**Brown spot (*Helminthosporium oryzae*)**

On the leaves small definite spots of oval or oblong shape and dark brown colour are formed. On susceptible varieties, spots are larger in size and are having light brown or grey center with dark reddish brown margin. The symptoms also appear on glumes as black oval or oblong spots or whole surface of the grain turn black and velvety.

**Narrow brown spot (*Cercospora oryzae*)**

Numerous narrow linear short brown spots are formed on the leaves.

**Stack burn (*Alternaria padwickii*)**

Symptoms appear on leaves as large oval or circular dark brown lesions with narrow distinct margins. On the affected grains pale brown to whitish spots with dark brown margin bearing black dots in the center are formed.

**Leaf scald (*Rhynchosporium oryzae*)**

Lesions with typical zonations with dark coloured wavy lines usually start from the tip of the leaves and extend downwards or arise from the margin and advance inside.

**Sheath rot (*Sarocladium oryzae*)**

The fungus infects the leaf sheath enclosing the panicle causing oblong or irregular brown

spots which later develop into a lesion with dark brown margin and grey center. The young panicle remains inside the sheath or rather chocked and emerge only partially. The grains become chaffy. A white powdery growth of the fungus can be seen on the surface of rotten sheath particularly inside the sheath.

**False smut (*Ustilaginoidea vireus*)**

The symptoms visible only after flowering when infected grains get transformed to yellow to orange spore balls, which later turns to dark green or black.

**Udbatta (*Ephelis oryzae*)**

Whole panicle transformed into a cylindrical rod covered with white mycelia. Later they become hard bearing many black dots.

**Foot rot (*Fusarium moniliformae*)**

Drying of leaves and leaf sheath, discolouration of lower nodes and adventitious root formation are the major symptoms. Plants turn pale yellowish green, thin and some times show abnormal elongation or rot in patches in the field.

**Bacterial diseases****Bacterial blight (*Xanthomonas oryzae* p v. *oryzae*)**

Bacterial blight is characterised by two phases of infection namely viz. Kresek and leaf blight. Kresek is drying or wilting of the whole plant. It affects the crop in early stages of growth in nurseries and upto 3-4 weeks after transplanting. The infected leaves become grayish green and begin to roll along the midrib and dry. In severe cases, the affected hills may be completely killed.

Leaf blight symptoms start as water soaked lesions on the tip of the leaves and increase in length downwards along the margins. Initially the lesions are pale green in colour and later turn into yellow to straw coloured stripes with wavy margins. Occasionally the linear lesions may develop anywhere on the leaf lamina or along the midrib with or without marginal stripes. Lesions may cover the entire leaf blade. The bacterial blight disease can be confirmed by ooze test. Cut the affected plants at the base and dip it in a glass of water and hold it against the light for few minutes without shaking. From the cut ends white milky bacterial ooze will come out as streams.

#### Bacterial leaf streak

(*Xanthomonas oryzae* p v. *oryzicola*)

Narrow brownish yellow translucent interveinal lines joining to form large dirty white patches.

#### Note :

1. Spray fresh cowdung extract for the control of bacterial blight. Dissolve 20 g cowdung in one litre of water; allow to settle and sieve. Use supernatant liquid.
2. Application of bleaching powder @ 5 kg ha<sup>-1</sup> in the irrigation water is recommended for preventing the spread of bacterial leaf blight particularly in the kresak stage.
3. Before application of antibiotics for the control of bacterial blight, confirm the disease by observing the bacterial ooze.
4. For control of sheath blight and sheath rot the following prophylactic measures may be adopted.
  - a) Apply neem cake-coated urea as recommended under fertilizer application.
  - b) Apply 50 per cent more potash than normal recommended dosage in split application.
  - c) Control weeds as suggested under weed control.
5. For control of sheath rot, spray the fungicides at the time of panicle emergence.
6. In organic farming, for the management of sheath blight of rice, spray Azadirachtin 0.03 per cent EC or Azadirachtin 0.15 per cent w/w @ 2.5 litres ha<sup>-1</sup> at the time of first disease appearance.
7. Spraying of recommended fungicide, preferably dithio carbamate before the heading stage of the crop may be followed for the control of false smut and leaf scald diseases. Wherever control measures are adopted for sheath blight and sheath rot diseases, separate fungicide spraying is not needed for the control of leaf scald and false smut. Use 500 litres of water for high volume spraying and 200 litres for low volume spraying. It is advisable to use different fungicides recommended on a rotational basis than using the same fungicide continuously.

Rice glume discolouration disease: Spraying commercially available carbendazim 12% + mancozeb 63% @ 750g ha<sup>-1</sup> is effective in controlling Glume discolouration disease in rice at the time of panicle emergence.

Table 11. Chemicals used for the control of rice diseases  
Foliar Sprays

A. Contact fungicides			
Sl. No.	Chemical	Dosage	Disease controlled
1.	Mancozeb 75 WP	2 kg ha <sup>-1</sup>	Leaf spot diseases but more specifically used against brown leaf spot
2.	Thiophanate 50 WP	500 g ha <sup>-1</sup>	Sheath blight and blast
3.	Copperhydroxide 77WP	1000 g ha <sup>-1</sup>	For false smut disease control at the time of 50% flowering stage, Sheath rot and glume discolouration
4.	Propineb 50 WP	1.25 kg ha <sup>-1</sup>	Glume discolouration, Brown spot
5.	Pencycuron 250 SC	750 ml/ha	Sheath blight
6.	Propineb 50 WP	1.25 kg/ha	Brown spot
B. Systemic fungicide			
1.	Iprobenphos 48 EC	500 ml ha <sup>-1</sup>	Blast and sheath blight
2.	Carbendazim 50 WP	500 g ha <sup>-1</sup>	Sheath blight and sheath rot
3.	Carboxin 75 or 80 WP	500 g ha <sup>-1</sup>	Sheath blight and sheath rot
4.	Hexaconazole 5 EC	800 - 1000 ml ha <sup>-1</sup>	Sheath blight, brown spot and glume discolouration
5.	Propiconazole 25 EC	500 ml ha <sup>-1</sup>	Sheath blight
6.	Carpropanid 27.8 SC	500 ml ha <sup>-1</sup>	Blast
7.	Isoprothiolane 40 EC	750 ml ha <sup>-1</sup>	Blast
8.	Propiconazole 25 EC	500 ml ha <sup>-1</sup>	False smut disease control at the time of panicle emergence stage
9.	Trifloxystrobin 25% + Tebuconazole 50%	200 g ha <sup>-1</sup>	Brown spot and glume discolouration Blast and sheath blight.
10.	Hexaconazole 5 WG	1000 g ha <sup>-1</sup>	Sheath blight
11.	Tebuconazole 250 EC	750 ml ha <sup>-1</sup>	Blast and sheath blight
12.	Fluzilazole 40 EC	250 ml ha <sup>-1</sup>	Sheath blight
C. Antibiotics (systemic)			
1.	Aureofungin sol	60 g ha <sup>-1</sup>	Blast and brown leaf spot
2.	Streptocycline	150 g <sup>-1</sup> 300 l <sup>-1</sup> ha <sup>-1</sup>	Bacterial blight, bacterial leaf streak
3.	Validamycin 3% liquid	1000 ml <sup>-1</sup> 500 l <sup>-1</sup> ha <sup>-1</sup>	Sheath blight

D. Biocontrol
Use biocontrol agents, <i>Trichoderma viride</i> and <i>Pseudomonas fluorescens</i> for the management of sheath blight of rice. Prophylactic application of talc based formulation of <i>Trichoderma viride</i> as - Seed treatment (10 g kg <sup>-1</sup> seed) + Soil application (2.5 kg ha <sup>-1</sup> ) one week after transplanting +Foliar spray (10g l <sup>-1</sup> ) after one month is effective for the management of sheath blight for upland rice. Prophylactic application of talc based formulation <i>Pseudomonas fluorescens</i> as - Seed treatment (10 g kg <sup>-1</sup> seed) + Soil application (2.5 kg ha <sup>-1</sup> ) one week after transplanting +Foliar spray (10g l <sup>-1</sup> ) one month after transplanting is effective for the management of blast, sheath blight, brown spot, sheath rot, glume discolouration and bacterial blight of rice.
E. Bio Pesticides for Sheath blight control :
Spray Neem formulations Azadirachtin 0.15 per cent WSP@ 2.5 l ha <sup>-1</sup> or Azadirachtin 0.03 per cent EC @ 2.5 l ha <sup>-1</sup> at the time of Sheath blight disease occurrence

#### Hints for reducing cost of cultivation

1. Grow a green manure crop like daincha in April-May in areas where the virippu crop is usually transplanted.
2. If Azolla is available, this may be applied instead of green leaf or FYM at 5t ha<sup>-1</sup>.
3. Puddle and level the field thoroughly. This will help to reduce the cost of weed control and also the loss of water and nutrients through percolation.
4. Maintain optimum plant density per unit area, i.e., 50 hills/m<sup>2</sup> for medium duration varieties and 67 hills/m<sup>2</sup> for early duration varieties.
5. Plant the seedlings shallow (3-4.5 cm), as shallow planting increases the tillering of seedlings.
6. Control the weeds during the vegetative phase itself. One weeding thoroughly on the 30<sup>th</sup> day after sowing is ideal. Use herbicides for weed control, wherever it is cheaper than hand weeding.
7. Under good management practices (vide item 1-6) reduce the dose of fertilizer N to half the present recommended level. Apply the fertilizer when the plant is able to make the best use of it, at tillering and seven days before panicle initiation.
8. When the field preparation and planting are done on rainy seasons, postpone the application of the basal dose of nitrogen to the early tillering stage (10 days after planting).
9. Use of Leaf Colour Chart (LCC): The leaf colour chart (LCC) is an instant, easy and low cost technique for N diagnosis of current crop and N topdressing in rice. The uppermost fully opened leaf of the primary tiller has to be taken for observation. Ten hills are selected at random for an area of 400 sqm and thus 10 leaves form the sample size. The leaf colour is compared with LCC and the readings are taken. The average of 10 readings gives the LCC value of the plot. Observation is taken at 10 days interval from 20 days after transplanting or 25 days after sowing upto heading. If the threshold value is less than 4, N@ 25-30 kg/ha is recommended for application. If the inherent soil N is low, basal N @ 25-30 kg ha<sup>-1</sup> is to be applied.
10. When the amount of available N is limited, apply it 7 days before panicle initiation. This is the best time for top dressing N.

11. Adopt agronomic practices for increasing fertilizer use efficiency such as: (a) Incorporating ammoniacal N in the reduced zone in the soil (b) Incubating urea with moist soil (1:6) for 24 hours (c) Blending urea with neem cake.
12. Choose fertilizer materials, which are cheaper, e.g. urea is cheaper than ammonium sulphate; rock phosphate is cheaper than superphosphate.
13. Apply phosphatic and potash fertilizers once in two seasons in areas where there is no marked response for these nutrients.
14. Adopt integrated pest management against insect pests and diseases.
15. Harvest the crop at optimum moisture content in order to avoid loss due to shedding and also for improving the recovery of rice.
8. Seedbed may be mulched, preferably using green leaves.
9. Sprinkle water over the seedbed for four days twice daily and keep soil in saturated condition. Never allow mat to dry up.
10. On 4<sup>th</sup> day remove the mulch and keep standing water to a height of 3/4<sup>th</sup> of seedling height. Keep this condition till the end of nursery period.
11. Closely observe the nursery for pest and disease attack and adopt control measures, if required.
12. When seedlings reach a height of 150 mm, mat is ready for transplanting.
13. Drain the required mat area 6-12 hours before cutting for feeding into the transplanter trays.
14. Cut the mat strips 225 mm wide and 450 mm long to match the measurements of the transplanter trays.

#### Mechanical Transplanting in Rice

##### A. Mat Nursery Preparation

1. Use very thin polythene sheet.
2. Select nursery area near to the main field
3. Cow dung powder may be incorporated @ one third volume of the puddled soil and spread over the sheet at a thickness of 10-15 mm.
4. The sheet may be spread after leveling the nursery area.
5. Form small bunds along the boundaries of the polythene sheet, after spreading it, to impound water.
6. Mat nursery may be of 900mm width and convenient length.
7. Just sprouted seeds (4<sup>th</sup> day of soaking) may be uniformly spread over the mat area @ 0.4 to 0.6kg m<sup>2</sup>.

15. Do not allow nursery to over grow. Over growing will lead to entanglement of seedlings with fingers of transplanter and clogging of fingers due to thick and hard mat of roots.

##### B. Main field

1. Prepare the main field adequately, without clods and stubbles interfering with functioning of finger.
2. Prepare main field sufficiently early to avoid floating of puddle while transplanter is working.
3. Final preparation may be done on the day of transplanting in case of sandy loam soil, but may be done 3-4 days prior to planting in case of clayey soils, depending upon settling time of the puddle to consolidate.

4. A thin film of water only is needed in the main field at the time of transplanting. (Too much water in the field will lead to floating of seedlings and too dry condition to non-anchoring of seedlings).
5. Main field should have irrigation and drainage facility.
6. Wetting of mat may be required while transplanter is in operation.

#### Integrated Pest Management (IPM) in rice

The indiscriminate use of pesticides for pest control has led to disturbances in natural ecosystem leading to resurgence of pests, secondary pests outbreak, toxic hazards and residues besides environmental pollution. This has led to major emphasis on Integrated Pest Management and gained greater momentum. Integrated Pest Management programmes promote favourable, ecological, economic and sociological outcome, which is accomplished by the best mix of pest control tactics. The use of appropriate scouting tactics, proper diagnosis of pest, the use of economic thresholds and conservation of naturally occurring biocontrol agents are fundamental components of a sound Integrated Pest Management programme. The use of chemical is restricted. It is used only if it is absolutely essential based on surveillance. The important components in the IPM are the use of tolerant/resistant varieties, regulating planting density, adjusting the time of planting/sowing, group farming practices, cultural management of pests, integrated nutrient management, removal of weeds, use of botanical pesticides and preservation of natural enemies. A list of common natural enemies of rice pests is given as Table 12. For the preservation of natural enemies, collect the egg masses of pests in perforated polythene bags and keep them in

the field so that the parasites that emerge can establish in the field effectively.

#### IPM Package:

- Seedling treatment with *Pseudomonas fluorescens*
- Nursery drenching with cartap hydrochloride @ 1kg a.i./ha
- Plant at a spacing of 20 x 15cms
- Provision of alleyways at every 3m rows
- Mass trapping with pheromone traps @ 8 traps/acre for yellow stem borer
- Release of egg parasitoids *Trichogramma japonicum* for stem borer and *T. chilonis* for leaf folder
- Spray with azadirachtin 1% at 15, 30, 45 and 60 DAT

*Trichogramma chilonis* and *Trichogramma japonicum* are egg parasitoids which effectively control egg mass of leaf roller, stem borer, skippers and cutworms. The parasitoids have to be released 15-30 days after transplantation or 25-30 days after sowing or immediately after noticing moth activity in the field. The release rate is 1 lakh parasitoids/ha of both size ( $5\text{cc ha}^{-1}$ ). The release has to be carried out at weekly intervals. The trichocard have to be cut into small pieces (minimum 10 pieces) and released in main field, 6-8 releases is necessary to control the pest.

Precaution : If larval attack is observed in the field, necessary organic/inorganic insecticides have to be used and a gap of 7 days has to be given before next release. The trichocards have to be placed during early morning or late evening hours and should not come in direct contact with sunlight.

Table 12. Common natural enemies of insect pests found in rice ecosystem

A. Predators	Description of biocontrol agents	
	Characters	Pest attacked
1	2	3
Spiders 1. Wolf spider 2. Lynx spider 3. Jumping spider 4. Long jawed spider 5. Dwarf spider 6. Orb spider	Female lays 200-800 eggs in life-time of 3-4 months. Both nymphs and adults are voracious feeders. It consumes 5-15 insect pests in a day depending up on the size.	Leaf and plant hoppers, leaf feeding caterpillars and adult stem borers.
Damsel and dragon flies	Multi-coloured with transparent narrow wings. Nymphs are aquatic and can climb up rice stems to search food. Adults fly normally below the rice canopy in search of flying insects.	Stem borers, hoppers and other flying insects.
Minid bugs	Adults are green and black at the shoulder. Nymphs are greenish. They can consume 7-10 eggs or 1-5 hoppers a day.	Leaf hoppers and plant hoppers.
Water bugs	Broad shouldered adults can be either winged or wingless. Each female lays 20-30 eggs in rice stumps above the water level. Life span 1-2 months. Winged adults disburse when rice plants dry up.	Plant hopper and other small soft-bodied insects.
Water treaders	They are solitary feeders	Stem borer larvae and hoppers that fall on water surface.
Water striders	Each strider takes 5-10 prey daily. They live for 1-1.5 month; lay 10-30 eggs.	Rice hoppers, moth and larvae that fall on the water surface
Ground beetle	Hard bodied insects. Larvae are shiny black and adults are reddish brown. Active predators, which pupate in the soil. Consume 3-5 larvae/day.	Plant hoppers and larvae of leaf folders.
Rove beetle	7mm long with short elytra and blue tip of abdomen. Found on rice plant, water and ground surface; active during night.	Leaf hoppers, plant hoppers and larvae of leaf folder and hairy caterpillar.
Lady bird beetles	Active during daytime. Found in the upper half of rice canopy. Feed on small and slow moving prey as well as on exposed eggs. Grubs are more voracious than adults and consume 5-10 prey. Produce 150-200 offsprings in 6-10 weeks.	Plant hoppers.
Crickets, Sword tailed crickets	Egg predators.	Eggs of stripped borer; leaf folder; armyworm and nymph of plant hoppers and leaf hoppers.

1	2	3
Grass-hoppers, Meadow grass hoppers	Distinguished from true grasshoppers by its long antennae, which are more than twice as long as its body length. Active at night and abundant in older fields. Can consume 3-4 yellow stem borer egg masses per day.	Eggs of rice bug and stem borer; nymphs of plant hoppers and leaf hoppers
B. Parasitoids		
1. Egg parasitoids		
Trichogramma japonicum Telenomus chilonis Tetrastychus sp.	Dark coloured tiny insects. Female wasp lays 20-40 eggs in the host egg. Development from egg to adult stage takes 10-40 days.	Stem borers and leaf folders.
Gonatocerus sp. Anagris sp.	Brown to dark yellowish brown tiny wasp. Females can reproduce without mating. Adults live 6-7 days and parasitise on an average 8 eggs/day.	Plant hoppers and leaf hoppers.
2. Larval parasitoids		
Cotesia sp. Stenobracon sp. Macrocentrus sp. Xanthopimpla sp. Charops sp.	Dark coloured wasp. Lives for 4-7 days.	Larvae feeding on stem, leaf and other parts of rice plant.

### C. Birds

- a. Install artificial nesting sites viz., wooden nest boxes in the rice fields (@ 12 nests ha<sup>-1</sup>) for colonization by cavity nesting birds (magpie robin, common myna, barn owl, etc.) which play a vital role in managing a variety of insect and non-insect pests. The nest boxes should be installed at a height more than 8 feet on wooden pole, tree trunk, etc.
- b. Installation of bird perches @ 50 ha<sup>-1</sup> increases the activity of insectivorous birds and reduces the pest population in rice fields. The perches should have a minimum height of 75 cm above the crop canopy for better visibility for the birds.
- c. Tying metalised reflective ribbon @ 20- 25 rolls ha<sup>-1</sup> at 75 cm above the canopy of the vulnerable stage of the crop on bamboo poles, 2.5 - 3.0 m apart at

convenient length, twisted at every 1 m length scares away the depredatory birds.

Effective and eco-friendly pest management in wet land rice ecosystem

1. Cultivate tolerant varieties.
2. Monitor the field at least at weekly intervals.
3. Pest and natural enemy population should be monitored for deciding spraying schedule.
4. Spraying should be avoided during the reproductive phase.
5. Spot application of insecticide may be adopted in heavily infested pockets to control further spread of the pest and to conserve the existing natural enemy population in rice ecosystem.



### Multi species integration in rice

Multi species integration is recommended in Kuttanad wetlands to the tune of 10000 fishes, 750 broiler ducks and 3-5 male buffaloes/annum/ha. Rice season is June-October. Fish fingerlings are stocked simultaneously in nursery ponds dug nearby. Fish species composition of grass carp, rohu and mrigal at 2:1:1 @10000 per ha. Broiler ducklings variety Vigoa @ 125-150/ha are grown in duck houses erected over the fish pond simultaneously. Ducklings are fed with formulated feed. Spilled over feed and excrements of duck fertilize the fish ponds. The ducklings are grown for 45-50 days and attain 2.5 - 3 kg. On an annuity basis 5-8 batches of broiler ducks can be reared. Duck excrements to the tune of 9-10 tons are recycled in this way. Paddy harvest will be over in 120-125 days. Paddy fields are

inundated after rice harvest and fishes are released to the expanded water body. The left over paddy straw on decomposition generate abundant food material in addition to the duck manure flowing down from the nursery pond. The fish species composition of grass carp and cyprinus is capable of feeding aquatic weeds and detritus straw. The field bottoms are tilled during foraging. The fishes are harvested prior to the next paddy season. Rice fields require no land preparation and preliminary weeding if the plant stand establishment is taken up within one week after the fish harvest. The paddy straw and wild grass available is sufficient to grow 3-5 male buffaloes for meat purpose. This farming system is capable to produce 6-8 tons of paddy grain, 1.8 to 2.25 tons of broiler duck, 2.5 to 3 tons of fish and 450 to 500 kg beef meat/ha/annum. Other major rice cropping systems of Kerala are included as Table 13.

Table 13. Cropping pattern / system

General	Rice	Rice	Fallow
	Rice	Rice	Vegetable/pulses/oil seeds/ green manure
Kuttanad	Water fallow	Water fallow	Rice
	Rice	Rice	Water fallow
Onattukara	Rice	Rice	Oil seed/green manure
Kole / Kaippad	Water fallow	Rice	Water fallow
	Water fallow	Rice	Rice
	Water fallow	Water fallow	Rice
Pokkali	Rice	Fish / prawn	—
High ranges	Rice	Rice	Fallow

## MAIZE (*Zea mays*)

Maize can be grown throughout the year at altitude ranging from sea level to about 300 m. Maize grows best in areas with rainfall of 600-900 mm. It requires fertile, well-drained soil with a pH ranging from 5.5-8.0, but pH 6.0-7.0 is optimum.

### Season

As a rainfed crop, maize is grown in June-July or August-September. The irrigated crop is raised in January-February.

### Varieties

Hybrids: Ganga Hybrid-1, Ganga Hybrid-101, Deccan hybrid, Renjit, Hi-Starch. Composite varieties: Kissan Composite, Amber, Vijay, Vikram, Sona, Jawahar.

### Seeds and sowing

Seed rate: 20 kg ha<sup>-1</sup>

Plough the land three times and prepare ridges and furrows. Dibble one seed per hole at a spacing of 60 cm x 23 cm for the rainy

season crop. For irrigated crop, beds are prepared. Here, seeds are sown in lines and earthed up later in to small ridges to form furrows when the crop reaches knee height.

### Manuring

Apply FYM/compost @ 25 t ha<sup>-1</sup> at the time of preparation of land. The recommended fertilizer dose is 135 kg nitrogen, 65 kg phosphorus and 15 kg potash per ha. Apply full dose of phosphorus and potash and 1/3 dose of nitrogen as basal. Apply 1/3 nitrogen, 30-40 days and the rest 60-70 days after sowing.

### After cultivation

Hand hoeing and weeding on the 21<sup>st</sup> and 45<sup>th</sup> day after sowing.

### Irrigation

Inigate the crop on the day of sowing and on third day. Subsequent irrigations may be given at 10-15 days intervals.

## SORGHUM (*Sorghum bicolor*)

Sorghum is a plant of hot and warm localities. The optimum temperature for growth is 30°C and it needs about 250-400 mm rainfall. Excess moisture and prolonged drought are harmful. It is fairly tolerant to alkalinity and salinity.

### Seasons

Rainfed crop : May-August

Irigated crop : January-April

### Varieties

Co.1, Co-10, Co-12, Co-17, K-1, K-2 Hybrids - CSH-1 to CSH-4, Co-11, Co-1

### Seeds and sowing

Seeds are sown @ 12-15 kg ha<sup>-1</sup>. Dibble two seeds/hole, at a spacing of 45 x 15 cm.

### Manuring

For both irigated and rainfed crops FYM / compost may be applied @ 5 t ha<sup>-1</sup>.

Fertilizers may be applied as follows:

Nutrients / ha	Irrigated crop	Rainfed crop
N	90 kg	45 kg
P <sub>2</sub> O <sub>5</sub>	45 kg	25 kg
K <sub>2</sub> O	45 kg	25 kg

Apply FYM and entire quantity of phosphorus and potash as basal dose. Apply

nitrogen in two equal splits, half as basal and the rest 30 days after sowing.

After cultivation

Thinning, weeding and hoeing may be done on the 20<sup>th</sup> day after sowing.

Irrigation

Irrigate the crop on the day of sowing and thereafter at 10 days interval.

## RAGI (*Eleusine coracana*)

Ragi is suited for cultivation in areas with annual rainfall of 700-1200 mm. It does not tolerate heavy rainfall and requires a dry spell at the time of grain ripening. It grows well in altitudes of 1000-2000 m with average temperature of 27°C. Ragi is cultivated mostly in red lateritic soils. Relatively fertile and well drained soils are the most suitable.

Seasons

Ragi is not a season bound crop and hence can be cultivated throughout the year, if moisture is available. It is usually grown during the following seasons.

Main season : June-September

Late season : July-October

Summer : Dec-Jan to March-April

Varieties

PR-202, K-2, Co-2, Co-7, Co-8, Co-9, Co-10.

Seeds and sowing

Seed rate

Direct sown crop : 5 kg ha<sup>-1</sup>

Transplanted crop : 4-5 kg ha<sup>-1</sup>

Spacing : 25 x 15 cm

Prepare the nursery field to a fine tilth. Incorporate FYM/compost 5 t ha<sup>-1</sup> and form beds and channels. Sow seeds uniformly on the beds and cover by stirring the soil. Apply carbaryl 10 per cent on the edges of the beds against ants. One week before uprooting seedlings, apply ammonium sulphate @ of 1 kg per 100 m<sup>2</sup>. A nursery area of 480

m<sup>2</sup> is necessary to raise seedlings for one hectare. Transplant the seedlings when they are three weeks old.

Manuring

Plough the field 3-4 times and incorporate FYM or compost 5 t ha<sup>-1</sup>. Apply nitrogen, phosphorus and potash @ 22.5 kg ha<sup>-1</sup> each before sowing or planting. Topdress nitrogen @ 22.5 kg ha<sup>-1</sup> 21 days after sowing or planting.

After cultivation

Weeding should be done three weeks after sowing and completed before top dressing.

Irrigation

Irrigate the field on the day of transplantation. Irrigation at weekly intervals increases growth rate and yield.

Plant protection

The pink stem borer, which causes dead heart symptoms, is often serious in the early stages of the crop. Insecticidal control is not needed for mild to moderate levels of infestation.

For controlling blast, spray mancozeb 750-1000 g ha<sup>-1</sup>.

Harvesting

Harvest the crop when the ears are yellowish brown. Heap the harvested ears and cover the heaps with ragi straw for 2-3 days before threshing.

## PULSES

### BLACK GRAM (*Vigna mungo*)

Black gram can be grown in rice fallows and uplands.

#### Season

It can also be grown as pure or mixed crop throughout the year.

#### Varieties

T-9, Co-2, S-1, TAU-2, TMV-1, KM-2, Syama and Sumanjana.

Variety T-9 is moderately tolerant to drought condition; CO-2 is photoinsensitive but susceptible to pests and diseases. S-1 is suitable for pappad making. TAU-2 is suited for partially shaded condition in coconut garden during rabi season in southern region; TMV-1 and KM-2 are suited for Onattukara tract during late kharif; Syama is suited for the summer rice fallow of Onattukara. Sumanjana is high yielding and early maturing variety, suitable for summer rice fallows of Trivandrum district.

#### Seeds and Sowing

Seed rate : Pure crop - 20 kg ha<sup>-1</sup>

Mixed crop - 6 kg ha<sup>-1</sup>

Spacing : 25 cm x 15 cm

Sowing: Plough the land 2-3 times thoroughly and remove weeds and stubbles. For seed treatment in black gram, two Rhizobium cultures viz. KAU-BG-2 and BG-12 are recommended.

#### Manuring

FYM 20 t ha<sup>-1</sup> (as basal)

Lime 250 kg ha<sup>-1</sup> (or dolomite 400 kg ha<sup>-1</sup>)

N 20 kg ha<sup>-1</sup>

P<sub>2</sub>O<sub>5</sub> 30 kg ha<sup>-1</sup>

K<sub>2</sub>O 30 kg ha<sup>-1</sup>

Lime may be applied at the time of first ploughing. Half the quantity of nitrogen, the whole of phosphorus and potash are applied at the time of last ploughing. The remaining 10 kg nitrogen can be applied as foliar spray of 2 per cent urea solution in two equal doses on the 15<sup>th</sup> and 30<sup>th</sup> day after sowing.

### COWPEA (*Vigna unguiculata*)

Cowpea can be grown throughout the year under Kerala conditions. It can be grown as a floor crop in coconut gardens where sufficient solar radiation is available and as an intercrop in tapioca during May-Sept. It can be grown as a pure crop in rice fallows during rabi and summer seasons.

#### Season

1. Cowpea can be grown during any season.

2. As a rainfed crop, sowing is done along with pre-monsoon showers.

3. During the second crop season (rabi), i.e., September to December, cowpea can be grown as a fringe crop along the rice field bunds. Sowing can be done on either side of bunds on the day of transplanting the paddy crop.

4. During summer, cowpea can be grown as a pure crop in rice fallows after the harvest of paddy.

#### Varieties

##### 1. Grain type :

C-152, S-488, Pusa Phalguni, P-118, Pusa Do Falsi, Krishnamony (PTB-2), V-240, Amba (V-16), GC-827, CO-3, Poumami (summer rice fallows) and Shubhra (suited for cultivation in rice fallows during summer season in southern districts of Kerala), Sreya and Hridya (Summer rice fallows of Onattukara). GC-3 and RC-101, DCS-47-1 (suited for rabi season).

##### 2. Dual purpose type :

Kanakamony (PTB 1), Anaswara and New Era

##### 3. As companion crop with tapioca : V-26

##### 4. Floor crop : Gujarat V-118, CO-2

#### Seeds and Sowing

##### Seed rate

For grain and dual purpose type

Broadcasting : 60-65 kg ha<sup>-1</sup>  
(45 kg ha<sup>-1</sup> for Krishnamony)

Dibbling : 50-60 kg ha<sup>-1</sup>  
(40 kg ha<sup>-1</sup> for Krishnamony)

Spacing : 25 cm x 15 cm Dibbling two seeds per hole

Bush : 30 cm X 15 cm

Trailing : 2 m X 2 m (on pandal @ three plants per pit)

#### Sowing

Soaking seeds in 500 ppm thiourea solution, followed by two sprays of thiourea (one at vegetative and another at flowering stage) increased the yield of cowpea by 26 per cent and net return by 50 per cent.

#### Seed inoculation and pelleting

Cowpea seeds should be inoculated with Rhizobium and pelleted with lime. Rhizobium cultures are available from the Assistant Soil Chemist, Microbiological Laboratory, Soil Testing Centre, Pattambi 679 306, Palakkad District. The strains that are available at Pattambi are the two isolates (No.11 and No.12) developed by the Kerala Agricultural University.

#### Procedure for seed inoculation

The content of each packet of Rhizobium inoculant is sufficient for seeds to be sown in the area indicated on the packet (250 to 375 g ha<sup>-1</sup>). Use the inoculant only for the specific leguminous crop mentioned on the packet, before the expiry date. Do not expose the Rhizobium culture to direct sunlight or heat. Mix the inoculant uniformly with the seeds by using minimum quantity of water (instead of water, either 2.5 per cent starch solution or kanjivellam of the previous day can be used in order to ensure better stickiness of the inoculant with the treated seed material). Take care to avoid any damage to the seed coat. Dry the inoculated seeds under shade over a clean paper or gunny bag and sow immediately. The Rhizobium culture or the inoculated seeds should not be mixed with chemical fertilizers.

#### Procedure for lime pelleting

1. Add finely powdered (300 mesh) calcium carbonate to moist fresh Rhizobium treated seeds and mix for 1-3 minutes until each seed is uniformly pelleted. Depending on the seed size, the following quantity of lime as required.

Small seeds	1.0 kg/10 kg of seed
Medium sized seeds	0.6 kg/10 kg of seed
Large sized seeds	0.5 kg/10 kg of seed

- Spread out the pelleted seeds on a clean paper to harden. Sow them as soon as possible. However, lime pelleted seeds can be stored up to one week in a cool place prior to sowing.

Note:

- Lime coating is required only for seeds that are to be sown in acid soils.
- Ordinary agricultural lime is not good for pelleting because of its larger particle size. Good quality high grade lime should be used.
- Hydrated lime should not be used for pelleting.
- The dry pellet should be firm enough to resist moderate pressure. It should appear dry without loose lime on its surface or in the container.
- The lime-pelleted seeds can be mixed with the fertilizer and sown. However, the period of contact between fertilizer and the pelleted seeds should be as short as possible.
- Pelleted seeds should not be sown into a dry seedbed.

Weed management : Pre-emergence application (0-3 days after sowing) of Pretilachlor @ 0.75 kg a.i./ha recommended to control grasses, sedges and broad leaved weeds in cowpea.

Spacing

For grain type and dual-purpose type, if dibbling is adopted, spacing of 25 cm between rows and 15 cm between plants is recommended with two seeds per hole. For bush vegetable type, spacing of 30 cm between rows and 15 cm between plants is suitable. For semi-trailing varieties, provide a spacing of 45 x 30 cm. Trailing varieties can be sown in pits (@ 3 plants/pit) at 2 x 2 m spacing for

trailing on pandal or in channels at 1.5 m x 45 cm spacing for trailing on trellis. If broadcasting is adopted, the seeds can be sown broadcast over the field and channels drawn after sowing.

Sowing

Plough the land thoroughly 2-3 times and remove weeds and stubbles. Make channels of 30 cm breadth and 15 cm depth at 2 m apart to drain off excess rainwater.

Manuring

FYM 20 t ha<sup>-1</sup>

Lime 250 kg ha<sup>-1</sup> (or dolomite 400 kg ha<sup>-1</sup>)

N 20 kg ha<sup>-1</sup>

P<sub>2</sub>O<sub>5</sub> 30 kg ha<sup>-1</sup>

K<sub>2</sub>O 10 kg ha<sup>-1</sup>

Lime may be applied at the time of the first ploughing. Half the quantity of nitrogen, whole of phosphorus and potash may be applied at the time of final ploughing. The remaining nitrogen may be applied 15-20 days after sowing.

[Note: For vegetable cowpea grown as an intercrop in the reclaimed alluvial soils of Kuttanad, nitrogen, phosphorus, and potash at the rate of 10, 20 and 10 kg ha<sup>-1</sup> are recommended. For vegetable cowpea, fertilizers can be applied in several split doses at fortnightly intervals.]

After cultivation

Hoing at the time of application of the second dose of nitrogen will give adequate aeration to the soil and help the root system to spread easily. For grain and dual-purpose varieties, decapitation is found to be advantageous as the crop shows trailing tendency. For vegetable types, provide trellis or pandal for trailing.

### Irrigation

Giving two irrigations is highly beneficial; i.e., at 15 days after sowing and at the time of flowering. Irrigation at the flowering stage induces better flowering and pod set.

### Plant protection

IPM package against major pests of cowpea

1. Burning of trash before sowing
2. Selecting healthy seeds
3. Clean cultivation
4. Soil drenching with Bordeaux mixture 1 per cent wherever fungal diseases are prevalent.
5. Treating the seeds with rhizobium culture @ 250 to 375 g ha<sup>-1</sup> before sowing.
6. Monitoring the field for incidence of pests/ population of natural enemies especially at flowering stage (for *Aphis craccivora*, epilachna beetles and pod borers) and at pod formation stage for pod bugs.
7. Adoption of mechanical methods of pest control such as application of ash at 10 DAS, keeping yellow sticky trap/ yellow pan tray, collection and destruction of infested leaves, flower buds and pods and sweeping and destruction of the pests.
8. Collection and release of potential natural enemies viz., grubs and adults of *Coccinella transversalis*, *Cheilo menes sexmaculatus*, *Harmonia octo maculata* and maggots of *Ischiodon scutellare*.
9. Spraying of neem oil emulsion 3 % or Dimethoate 2 ml/l<sup>-1</sup> at the time of aphid incidence. Need based application of *Lecani cillium lecanii* @ 10<sup>7</sup> spores/ml or *Beauveria bassiana* @ 10<sup>7</sup> spores/ml for the management of *A. craccivora* and pod bugs.

10. Need based application of neem kernel suspension (NKS) 5 per cent or chlorpyrifos 0.05 per cent at 45 DAS in the case of moderate incidence of *A. craccivora*, and a second spray using NSK 5% at 60 DAS if needed against pod bugs. Need based application of neem kernel suspension (NKS) 5% or flubendiamide 20 WG @ 50 g a.i/ha or chlorantraniliprole 18.5 SC @ 30 g ai/ha or spinosad 45 SC @ 75 g a.i/ha or indoxacarb 14.5 SC @ 60 g a.i/ha at moderate incidence of pod borers and second spray after 15 days if needed.

For protecting cowpea seeds against pests under storage conditions, smear the seeds with groundnut or coconut oil at 1.0 per cent.

Spraying quinalphos 0.03 per cent at 60 DAS in the field along with treatment in storage with dried powdered rhizome of Vayambu (*Acorus calamus*) 01kg/100kg seed.

The root-knot nematode and reniform nematode associated with cowpea can be effectively managed by the application of neem and eupatorium leaves @ 15 t ha<sup>-1</sup>, two weeks before sowing.

Spray 1 per cent Bordeaux mixture in early stages to protect the crop from fungal diseases.

### Anthracnose of cowpea

(*Colletotrichum lindemuthianum*)

Causes water soaked lesions on leaves, which later become brown and enlarge to form circular spots. The infection may spread to the petiole and young stem also. Petiole infection results in defoliation. For protecting the crop from anthracnose, treat the seeds with carbendazim (0.05 per cent) and spray the crop

with Bordeaux mixture 1 per cent or carbendazim 0.05 per cent.

Dry root rot of cowpea

(*Macrophomina phaseolina*)

Infected plant suddenly wilts and dies. The bark of the root and basal stem becomes fibrous. The disease appears in patches and become severe during dry periods. Dry root rot can be managed by seed treatment with *Trichoderma viride* @ 4g kg<sup>-1</sup> of seed or carbendazim 1g kg<sup>-1</sup> of seed or *Pseudomonas fluorescens* @ 10g kg<sup>-1</sup> of seed or neem cake soil application @ 20 kg ha<sup>-1</sup>. Dry root rot of

cowpea can be managed with carbendazim seed treatment (2g kg<sup>-1</sup> of seed), drenching (2g l<sup>-1</sup>) at 15 DAS and spraying (2g l<sup>-1</sup>) at 30 DAS.

Fusarium wilt, root rot, web blight and collar rot of cowpea

- \* *Trichoderma viride* seed treatment (20 g kg<sup>-1</sup> seed) + soil drenching (2%) at 20, 40 and 60 days after sowing (DAS)
- \* Soil drenching of cowdung slurry supernatant 2% + *Pseudomonas fluorescens* 2% at 20, 40 and 60 days after sowing (DAS)

## FRENCH BEAN (*Phaseolus vulgaris*)

Light sandy-loam to clayey-loam soils with good drainage are best suited for the crop.

Season

In the high ranges of elevation more than 1000 m, this crop can be grown throughout the year. The crop being susceptible to ground frost in higher altitudes (above 1400 m), adequate protection should be given during January-February.

Varieties

There are two types of French beans viz., pole beans and bush beans.

Pole beans : Kentucky Wonder

Bush beans : Contender, Premier, YCD-1, Arka Komal, Tender Green

Seeds and sowing

Seed rate

80 kg ha<sup>-1</sup> for hills

50 kg ha<sup>-1</sup> for plains

Sowing

Prepare land thoroughly by ploughing. Raised beds are not essential for bush beans.

For pole beans, raised beds are advantageous. Spacing of 30 cm x 20 cm is recommended.

Manuring

Apply basal dose of 20 t ha<sup>-1</sup> of FYM and N:P<sub>2</sub>O<sub>5</sub>:K<sub>2</sub>O @ 30:40:60 kg ha<sup>-1</sup>. Top dressing with 30 kg N ha<sup>-1</sup> may be given 20 days after sowing.

After cultivation

Provide support, 1 to 1.5 m long for trailing the plants. First weeding can be given about 4 weeks after sowing and second weeding will be essential 50 days later. Pods become ready for harvest in 50-60 days in the case of bush beans and in 70-80 days for the pole beans. The average yield of green pods is 8-10 t ha<sup>-1</sup>.



## GREEN GRAM (*Vigna radiata*)

Green gram is grown as a pure crop in rice fallows after the harvest of the first or second crop of paddy. It can also be grown as a mixed crop with tapioca, colocasia, yam and banana or as an intercrop in coconut gardens.

### Varieties

Philippines, Madiera, Pusa Baisakhi, NP-24, Co-2, Pusa-8973 (Pusa-8973 is suited to the summer rice fallows of Onattukara; tolerant to pod borer; duration 66 days).

### Seeds and sowing

#### Seed rate

Pure crop 20-25 kg ha<sup>-1</sup>

Mixed crop 6 kg ha<sup>-1</sup>

### Sowing

Plough the land 2-3 times thoroughly and remove weeds and stubbles. Channels, 30 cm broad and 15 cm deep, are drawn at

2 m apart to drain off excess rain water during kharif season and provide irrigation during summer season. The seeds may be sown broadcast.

### Manuring

FYM 20 t ha<sup>-1</sup> (as basal)

Lime 250 kg ha<sup>-1</sup> or dolomite 400 kg ha<sup>-1</sup>

N 20 kg ha<sup>-1</sup>

P<sub>2</sub>O<sub>5</sub> 30 kg ha<sup>-1</sup>

K<sub>2</sub>O 30 kg ha<sup>-1</sup>

Lime may be applied at the time of first ploughing. Half the quantity of N and the full quantity of P<sub>2</sub>O<sub>5</sub> and K<sub>2</sub>O may be applied at the time of last ploughing. The remaining quantity of N (10 kg) can be applied as foliar spray of 2 per cent urea solution in two equal doses on the 15<sup>th</sup> and 30<sup>th</sup> day after sowing.

## GREEN PEA (*Pisum sativum*)

Green pea can be successfully grown in altitudes above 1000 m in the cool season. Well-drained loamy and laterite soils are suitable.

### Season

The crop is sown in October-November after abatement of the southwest monsoon showers. Crops sown beyond January will not give satisfactory result.

### Varieties

Bonnevilla, Markserbsen (These are short duration varieties with long green pods each containing 7-8 kernels; suitable for canning).

### Seeds and sowing

Adopt seed rate of 60 kg/ha and spacing of 15-20 cm between rows and 10 cm between plants. Place the seeds at a depth of 2 to 2.5 cm. Line sowing is helpful for training the vines on standards.

### Land Preparation

The land should be prepared thoroughly by ploughing, digging and removing all stems, stubbles, etc. For early-sown crop, raised beds of 1 m width and 5 cm height may be prepared for sowing the seeds. If irrigation is necessary, provide furrows between rows for guiding water.

**Manuring**

Apply FYM or compost @ 20 t ha<sup>-1</sup> and N:P<sub>2</sub>O<sub>5</sub>:K<sub>2</sub>O @ 30:40:60 kg ha<sup>-1</sup> as basal dressing. In soils of medium fertility, top dressing of nitrogen @ 30 kg ha<sup>-1</sup> four weeks after sowing is essential.

**After cultivation**

Weed the plots four weeks after sowing and 50 days later. Provide support for training the vines. Pods can be harvested when the grains are fully developed. In short duration varieties, harvesting will be over within

100-120 days while long duration varieties will normally take 140-160 days.

**Plant protection**

Soak the seeds before sowing in a copper-based fungicide solution. Spray malathion 0.1 per cent suspension at 15-20 days interval for the control of aphids. Stop application of chemicals 10 days before harvesting. Powdery mildew can be controlled by spraying thiophanate methyl 0.05 per cent. For control of downy mildew, spray any of the copper fungicides at a concentration of 0.2 to 0.3 per cent.

**HORSE GRAM (*Macrotyloma uniflorum*)**

Horse gram can be grown in paddy nurseries after transplantation of the second crop and in palliyal lands after harvest of first crop and uplands during rabi season.

Season: September-October  
Variety: Co-1 and Pattambi Local  
AK-21 and AK-42 (Photo insensitive varieties)

**Seeds and sowing**

Seed rate: 25-30 kg ha<sup>-1</sup>

**Sowing**

After land preparation, sow the seeds either dibbled in rows 25 cm apart or by broadcast.

**Manuring**

Lime 500 kg ha<sup>-1</sup>  
P<sub>2</sub>O<sub>5</sub> 25 kg ha<sup>-1</sup>

**RED GRAM (*Cajanus cajan*)**

Red gram (Pigeon pea) is suitable for the tropics. The most favourable temperature range is 18-30°C. The crop is grown at a wide range of elevation. Red gram can be grown in almost all soil types that are not very poor in lime and are not subjected to waterlogging. Optimum growth and yield are obtained in deep loam soils. Red gram can be grown as mixed crop with groundnut, paddy or tapioca or as a pure crop.

**Season**

Sowing can be done in two seasons. As a mixed crop, sow the seeds in June-July. Red

gram can also be sown in paddy fields after the harvest of mundakan crop.

Variety: SA 1

**Seeds and sowing****Seed rate**

Pure crop 15-20 kg ha<sup>-1</sup>

Mixed crop 6-7 kg ha<sup>-1</sup>

**Sowing**

When sown with groundnut, spacing recommended between rows is 3 to 3.5 m. In

the dibbled crop, a spacing of 35 cm between rows is recommended. Thinning is to be done, if necessary.

#### Manuring

Lime	500 kg ha <sup>-1</sup>
Cattle manure	3000 kg ha <sup>-1</sup>
N	40 kg ha <sup>-1</sup>
P <sub>2</sub> O <sub>5</sub>	80 kg ha <sup>-1</sup>

#### After cultivation

Weeding and intercultivation once in three weeks will ensure a good crop.

#### Plant protection

Pod borer is the main pest. For controlling this, spray the crop with 0.05 per cent quinalphos suspension at the time of flowering. The blister beetle, *Zonabris*, gregariously feeds on the flowers.

## SOYBEAN (*Glycine max*)

Soybean is grown, mainly in areas where the summer is hot and humid. However, it does not withstand extreme summer and winter. The optimum temperature for growing soybean is 25-30°C. Well-drained sandy or clay loams and alluviums with good fertility are generally suitable for the cultivation of the crop. When taking up cultivation in a new area, inoculation with the culture of *Rhizobium* is desirable.

#### Season

The crop will perform best when sown by the onset of south-west monsoon. Sowing after the onset of heavy showers will result in poor germination and growth. Though it can be grown in other seasons under irrigation, its performance will be poor. If flowering coincides with rainy season, fruit set will be adversely affected.

#### Varieties

Bragg, JN-2750, EC-2661

These varieties have duration of about 4 months when sown in May-June. The duration will be less in other seasons.

#### Seeds and sowing

Seeds may be sown either in lines 45 cm apart at a distance of 10 cm between seeds in

a row or by giving a plant-to-plant distance of 20 cm.

#### Land Preparation

As waterlogging will affect germination and growth of the crop, it may be sown in raised beds during rainy season.

#### Manuring

Apply fertilizers to provide N:P<sub>2</sub>O<sub>5</sub>:K<sub>2</sub>O @ 20:30:10 kg ha<sup>-1</sup>. The fertilizers may be applied basally. In soils of low fertility, application of organic manures is beneficial.

#### After cultivation

Weed the plots once or twice depending on weed growth. As the crop smothers the field after initial growth, weed control will be necessary only up to 30-40 days after sowing. Earthing up at the time of weeding is beneficial.

#### Plant protection

The crop is free from infestation of major pests. The minor pests include stem fly (*Melanagromyza* sp.) and leaf roller (*Lamrosema* sp.). The stem fly mines into stem and the plant withers and dries up. Damage is more serious in young plants. The leaf miner causes pale brown patches along the lamina. The flower thrip feeds within flowers and prevents seed formation.

### Collar rot

The diseases include collar rot (*Rhizoctonia solani*) which causes water soaked lesions at the collar region which later spread along the whole stem. The plant succumbs in a few days. The disease occurs in patches under high soil moisture and high organic matter levels. To control the disease, provide good drainage (Refer cowpea).

### Anthracnose

Anthracnose caused by *Colletotrichum lindemuthianum* is also common. The fungus causes dark brown elongated, more or less angular spots along the veins on the petioles, stem and lamina. When infection occurs on the hypocotyl, the plant collapses. Seeds when infected turn brown or black. To control the disease, select seeds from disease free plots (Refer cowpea).

### Mosaic disease

The spread of mosaic disease, characterized by mottling, curling and distortion of leaves and malformations of the pod is checked by rouging out the infected plant and spraying dimethoate 0.05 per cent to control the insect vectors.

### Pod blight

The pod blight (*Diaporthe phaseolorum*) causes irregular spots with discoloured border on the leaves and pods. Crop rotations, destruction of diseased plants and prophylactic foliar application of mancozeb 0.3 per cent are recommended to control the disease.

### Harvesting and yield

The crop will be ready for harvest in about 4 months after sowing. Yellowing of leaves and their shedding are signs of maturity. If the period of maturity is rain free, the crop may be left in the field for about a week after complete leaf shedding. If the period is rainy,

the crop may be harvested after leaf shedding and the produce may then be dried in shade for about 10 days. After drying, seeds may be separated by beating with stick. Soybean seeds lose viability after about a year. By drying the seeds to moisture content less than 10 per cent, reasonable viability can be maintained up to one year. If it is not for sowing, the seed may be stored for up to three years after drying.

### Value addition

The bulk of the soybean is processed industrially into oil and protein. It may also be used as a pulse for direct consumption after cooking. It can be substituted for black gram and other pulses in the common household preparations. The soybean preparations will have the characteristic soy odour, which can be eliminated by treatment. Soybean may also be used for making soymilk, soymilk shake, etc.

### Preparation of soybean milk

Mature dry beans are washed thoroughly and soaked in water for 8-10 hours. Remove the husk (testa) by gently pressing the soaked seeds. Wash thoroughly and grind to a thick paste. Alternatively, the beans may be steamed and ground. Add water 6-8 times the volume of seeds and bring to boil. Strain through muslin cloth. Boil once again under gentle stirring. This milk can be kept for 5 days in refrigerator. Periodic boiling will increase the storage life of soymilk.

Soybean has a characteristic "bean flavour" which is not relished by many. The acceptability of the soymilk can be improved by removal of the "bean flavour". For this, soak soybean in 5 per cent starch solution preheated to 80°C for 8-12 hours. The starch solution drained from cooked rice (kanjivellam) can be used for this purpose. Soaking the beans for half an hour in hot starch water and then repeated washing with cold water is required.

## TUBERS

### ELEPHANT FOOT YAM (*Amorphophallus paeoniifolius*)

Elephant foot yam requires fairly long growing season and a rainfall of about 150 cm during the crop period. A well-drained soil of medium texture is suited for this crop.

#### Season

Corn pieces are normally planted during February-March, before the onset of monsoon.

#### Varieties

**Sree Padma** : The crop matures in 8-9 months. Cooked tubers are free from acidity.

**Sree Athira** : First genetically improved variety with very good cooking quality.

#### Seeds and sowing

Tuber cut-pieces having a portion of central bud and weighing about 1 kg are ideal for planting. Dip the pieces in cowdung slurry and allow to dry under shade before planting. Nematodes associated with *amorphophallus* can be controlled by seed material treatment with talc based formulation of *Bacillus macerans* @ 3g ( $10^6$  cfu/g) per kg of coms. After planting, cover the pit with dried leaves or other mulching materials. About 12,000 cut pieces weighing about 12 t are required for planting one hectare. Most of the seed material will germinate within one month after planting.

Mealy bugs usually attack the corn in field and store. Avoid planting coms already infested.

#### Land Preparation

Dig pits of 60 cm x 60 cm x 45 cm size 90 cm apart. Collect the topsoil to a depth of 15-20 cm separately and fill it after the pits are formed. Apply cowdung or compost at 2-2.5 kg/pit and mix with topsoil.

Minisetts technique for quality planting materials

Minisetts weighing 100 g each can be planted directly in nursery beds or in the main field with the central bud portion facing up at a spacing of 60 cm x 45 cm. A total of 37,000 minisetts/ha is required as against 12,345 setts/ha in the traditional method. Multiplication ratio in elephant foot yam could be enhanced to 1:15 as against the conventional 1:3 by adopting minisetts technique.

#### After cultivation

Apply full dose of  $P_2O_5$  and half the dose N and  $K_2O$  ( $N:P_2O_5:K_2O$  @ 50:50:75 kg ha<sup>-1</sup>) after forty five days of planting along with intercultivation and weeding. Apply second dose of fertilizers (N and  $K_2O$  @ 50:75 kg ha<sup>-1</sup>) one month after the first application along with intercultivation and earthing up.

#### Harvesting

The crop will be ready for harvest 8-9 months after planting.

Organic farming technology for elephant foot yam

#### Recommendation

 Raising green manure cowpea (seed rate @ 20 kg ha<sup>-1</sup>) prior to elephant foot yam and incorporation of green matter at 45-60 days.

 Use of organically produced planting materials.

 Treatment of corn pieces of 500-750 g with slurry containing cowdung, neem cake and *Trichoderma harzianum* (20g kg<sup>-1</sup> seed) and drying under shade before planting.

**EO** **OH** Application of *Trichoderma harzianum* incorporated FYM @ 36 t ha<sup>-1</sup> (3 kg pit<sup>-1</sup>) in pits at the time of planting (FYM, neem cake mixture (10:1) inoculated with *Trichoderma harzianum* @ 2.5 kg t<sup>-1</sup> of FYM neem cake mixture. *Trichoderma* can be multiplied in FYM alone but it will take 15 days to form sufficient inoculum as against 7-8 days if neem cake is also used along with FYM). This is effective against collar rot caused by *Sclerotium rolfsii*.

**EO** **OH** Application of neem cake @ 1.0 t ha<sup>-1</sup> (80-85 g pit<sup>-1</sup>) in pits at the time of planting.

**EO** **OH** Inter-sowing of green manure cowpea (seed rate @ 20 kg ha<sup>-1</sup>) between elephant foot yam pits and incorporation of green matter in pits at 45-60 days. The green matter addition from the 2 green manure crops should be 20-25 t ha<sup>-1</sup>.

**EO** **OH** Application of ash @ 3 t ha<sup>-1</sup> (250 g pit<sup>-1</sup>) at the time of incorporation of green manure in pits.

## XANTHOSOMA (TANNIA) (*Xanthosoma sagittifolium* L. Schot)

Tannia is suited to warm humid climate with high rainfall. But can be grown in areas of 100-200 cm rainfall, provided it is evenly distributed. It is usually grown from sea level up to 1350-1500 m over a wide range of temperature (13 to 29°C). It is less tolerant to drought but cannot withstand water logging. This crop can tolerate light shade but the aerial part dies down with increasing shade. It can be grown on a wide variety of soils except hard clay or pure sands, but requires a deep well drained, fertile loamy soil, preferably with a pH of 5.5 to 6.5 with a mean soil temperature above 20°C. It can be grown as pure crop as well as intercrop in coconut, banana, rubber and other plantations.

### Season

Rainfed crop : February- March to November-December.

Irigated crop : Throughout the year.

### Varieties

There is only a single variety released so far in this crop by name 'Konkan Haritpami' which is mostly adopted in Konkan and

adjoining areas as a rainfed crop. It matures within 190-210 days, the cooking quality of the cormels is good and the leaves are edible. But local selections having tubers with low acidity, good texture and leaves with vegetable use are also available.

### Seeds and sowing

Healthy cormels of 50-100 g weight and 20-25 cm long and cut corms of 150-200 g size are commonly used. For planting one hectare, 1.8-2.5 tons of corms or 0.6-1.0 ton of cormels are required. Usually seed materials are planted 6-7 cm deep. While planting the cut pieces of the main corm or suckers, it is advisable to keep the apical portion above the ground level.

### Land preparation

The land is usually made to a fine tilth and ploughed to a depth of 20-40 cm followed by the formation of ridges and furrows especially in heavy textured soils. Planting on ridges or mounds is often recommended since tuber formation is improved when adequate drainage is provided. A spacing of 90 X 90 cm is usually practiced with a planting density of 12,345

plants ha<sup>-1</sup> and pits converted to mounds is the usual method of planting.

#### Manuring

Soil amendment (dolomite), cattle manure and NPK @1 ton ha<sup>-1</sup>, 25 tons ha<sup>-1</sup> and 80:50:150 kg ha<sup>-1</sup> respectively is recommended for cultivation. Apply dolomite during first land preparation atleast 15 days before planting. Apply cattle manure and P as basal. 25% recommended Nitrogen is applied as chemical fertilizer. To meet the remaining 75% Nitrogen sow green manure cowpea in the interspaces @ 20 kg ha<sup>-1</sup> immediately after planting tannia and incorporate at 45-60 days. Application of N bio-fertilizer @ 10 g per plant within one month of planting and application of neem cake in pits after one month of the bio-fertilizer application has to be done. Chemical N (25%) and K are applied in 3 splits of 2, 4 and 6 months after planting.

#### After cultivation

Weeding and earthing up should be done twice at 1 and 2 months after planting. In some areas, earthing up three times along with weeding and fertilizer application is recommended. When crop is grown in kitchen garden without applying any fertilizer, weeding is done especially at the early stage of plant growth. Lower leaves and petioles should be removed when they start drying.

#### Mulching

As the crop respond well to mulching, after planting, green leaf mulching @ 15 tons per ha was found beneficial for maximum corm as well as comel production.

#### Irrigation

During summer and drought periods, it is essential to give 5-6 shallow irrigations to maintain soil moisture. Maintenance of

adequate soil moisture, proper shade to sustain a humid microclimate and avoiding full exposure to sunlight is a must for good crop growth, better tuber and leaf yield.

#### Plant protection

Dasheen mosaic virus was found to a small extent. Use of disease free planting materials can avoid the incidence of this problem. Usually it was manifested as a secondary infection when nutritional disorders in the form of Mg deficiency became severe in the crop.

#### Nutritional disorders

When the crop is grown in laterite soils of Kerala, interveinal chlorosis of the lower leaves characteristic to Mg deficiency was prevalent from 3rd month of growth causing complete devastation of crop. As tannia is identified as an indicator plant for Mg deficiency, application of dolomite @ 1 ton per ha during land preparation is advocated to prevent the problem in these soils.

#### Harvesting

Crop can be harvested when older leaves start yellowing and drying usually during 9-11 months of planting. As the coms and comels do not deteriorate if left unharvested, harvesting can be done from 6 months till 10-12 months. If mature comels are not harvested, most of them will sprout at rain, become watery and less suitable for consumption.

#### Storage of seed material

After harvesting, curing of the coms and comels is done under sunlight for 4-5 days. They can also be stored by embedding in dry soil or sand for a period of 4-5 months under ventilated, dry and semi dark conditions. Care should be taken to avoid injury to the coms and comels while harvesting.

## COLOCASIA [TARO] (*Colocasia esculenta*)

Colocasia is a crop of tropical and sub-tropical regions and requires a warm humid climate. Under rainfed conditions, it requires a fairly well distributed rainfall around 120-150 cm during the growth period. Well-drained soil is suitable for uniform development of tubers.

### Season

Rainfed crop : May-June to Oct-Nov.

Irrigated crop : Throughout the year

### Varieties

Sree Rashmi, Sree Pallavi and Sreekiran are three improved varieties.

Sree Rashmi - Economic yield under low input levels, conical corms and 7 months duration.

Sree Pallavi - Field tolerant to leaf blight and mosaic, club shape corms and 7 months duration.

Sreekiran - First hybrid taro variety in India, long keeping quality of corms and 6½ - 7 months duration.

### Seeds and sowing

Use side tubers each of 25-35 g for planting. About 37,000 side tubers weighing about 1200 kg are required to plant one hectare.

### Land preparation

Plough or dig the land to a depth of 20-25 cm and bring to a fine tilth. Make ridges 60 cm apart. Plant the side corms at a spacing of 45 cm on the ridges.

### Mulching

Soon after planting, cover the ridges with suitable mulching materials for retention of moisture and to control weeds.

### Manuring

Apply cattle manure or compost @ 12 t ha<sup>-1</sup> as basal dressing, while preparing the ridges for planting. A nutrient dose of 80:25:100 kg of N:P<sub>2</sub>O<sub>5</sub>:K<sub>2</sub>O ha<sup>-1</sup> is recommended. Full dose of P<sub>2</sub>O<sub>5</sub> and half dose of N and K<sub>2</sub>O should be applied within a week after sprouting and the remaining half dose of N and K<sub>2</sub>O one month after the first application along with weeding and earthing up.

### After cultivation

Inter-cultivation is essential in colocasia. Weeding, light hoeing and earthing up are required at 30-45 days and 60-75 days after planting. The leafy parts may be smothered about one month before harvest so as to enhance tuber development.

### Irrigation

Ensure sufficient moisture in the soil at the time of planting. For uniform sprouting, irrigate just after planting and one week later. Subsequent irrigation may be given at 12-15 days intervals, depending on the moisture retention capacity of the soil. The irrigation should be stopped 3-4 weeks before harvest. About 9-12 irrigations are required for the crop till harvest. In the case of rainfed crop, if there is prolonged drought, supplementary irrigation is required.

### Plant protection

Colocasia blight can be controlled by spraying mancozeb or copper oxychloride formulations at 2 g l<sup>-1</sup> of water (1 kg ha<sup>-1</sup>). For controlling serious infestation of aphids, spray dimethoate at 0.05 per cent. Leaf feeders can be controlled by spraying malathion 0.1%.

### Harvesting

Colocasia becomes ready for harvest five to six months after planting. The mother corms and side tubers are separated after harvest.



### Storage of seed material

The side tubers to be used as planting materials are usually separated from the mother corm and stored. Keep seed tuber in sand spread over the floor to avoid rotting.

### Organic Farming of Taro

Application of FYM @ 15 t ha<sup>-1</sup> in pits at the time of planting (400 g plant<sup>-1</sup>), application of neem cake @ 1 t ha<sup>-1</sup> in pits at the time of

planting (30 g plant<sup>-1</sup>), application of biofertilizers Azospirillum @ 3 kg ha<sup>-1</sup>, mycorrhiza @ 5 kg ha<sup>-1</sup> and phospho bacteria @ 3 kg ha<sup>-1</sup>, inter-sowing of green manure cowpea (seed rate @ 20 kg ha<sup>-1</sup>) between yam mounds and incorporation of green matter at 45-60 days. (Green matter addition from the green manure @ 15-20 t ha<sup>-1</sup>), and application of ash @ 2.0 t ha<sup>-1</sup> at the time of incorporation of green manure in pits (60 g plant<sup>-1</sup>).

## DIOSCOREA (YAMS)

### 1. GREATER YAM (*Dioscorea alata*)

Greater yam is predominantly a tropical plant. The crop cannot withstand frost and excessively high temperatures. Temperature around 30°C and rainfall of 120-200 cm distributed throughout the growth period are ideal. Day length greater than 12 hours during initial stages and shorter day length during the later part of the growing season favour satisfactory tuber formation. Yam requires loose, deep, well-drained, fertile soil. The crop does not come up well in waterlogged conditions.

#### Season

Seed tubers are normally planted during the later part of the dry season (March-April) and start sprouting with the onset of pre-monsoon showers. If the planting is delayed, yams start sprouting in storage, which is not desirable for planting.

#### Varieties

1. Sree Keerthi : Suitable for intercropping in mature coconut garden and with banana.
2. Sree Roopa : Possesses excellent cooking quality.

3. Indu : This is recommended as a pure crop and also as an intercrop of coconut in the reclaimed alluvial soils of Kuttanad.
4. Sree Shilpa : This is the first hybrid having good culinary quality. The crop matures early, within 8 months. The tubers have 33-35 per cent dry matter, 17-19 per cent starch, 1.4-2 per cent protein and 0.8-1.2 per cent sugar.
5. Sree Karthika : High yielded, excellent cooking quality. The crop matures within 9 months. The tubers have 21.42 per cent starch, 1.14 per cent sugar and 2.47 per cent crude protein.

#### Seeds and sowing

*D. alata* produces mostly a single big tuber in which only one head end of the tuber is available as good seed material. For getting the head end in each propagation unit, the whole tuber is divided longitudinally. Each piece of cut tuber should weigh at least 250-300 g. Dip the pieces in cowdung slurry and allow to dry under the shade before planting. About 2500-3000 kg of seed material is required to cover one hectare of land.

### Preparation of land

Plough or dig the land up to a depth of 15-20 cm. Dig pits of size 45 x 45 x 45 cm at a distance of 1 x 1 m. Fill up three fourth of the pits with 1-1.25 kg cattle manure or compost and mix with top soil. Plant the cut tuber pieces and completely cover the pit with leafy materials to conserve soil moisture and maintain optimum temperature.

### Manuring

Apply cattle manure or compost @ 10-15 t ha<sup>-1</sup> as basal. An NPK dose of 80:60:80 kg ha<sup>-1</sup> has to be applied in two splits; half dose of N, full P<sub>2</sub>O<sub>5</sub> and half of K<sub>2</sub>O within a week after sprouting; remaining half N and half K<sub>2</sub>O

one month after the first application along with weeding and earthing up.

### Trailing

Trailing is essential to expose the leaves to sunlight. Trailing has to be done within 15 days after sprouting by coir rope attached to artificial supports in the open areas or to trees where they are raised as an intercrop. When grown in open areas, trail to a height of 3-4 m. Trail the vines properly as and when side shoots are produced.

### Harvesting

The crop becomes ready for harvest within 8-9 months after planting when the vines are completely dried up. Dig out the tubers without causing injury.

## 2. LESSER YAM (*Dioscorea esculenta*)

It is grown in a similar agro-climatic situation as that of *D. alata*. Planting season and manuring are also similar.

### Varieties

1. Sree Latha : This is a selection from Thiruvananthapuram district with a duration of 8 months. Tubers are oblong to fusiform with creamy white flesh. Vines twine to the left.
2. Sree Kala : This is an early variety with 7.5 months duration. The tubers have 35-37 per cent dry matter, 23-25 per cent starch and 1-1.3 per cent sugar.

### Seeds and sowing

Select medium size tubers weighing about 100-150 g each. Plant the whole tuber, one in each mound and cover completely with soil. Mulch the mounds to maintain optimum

temperature and moisture. To plant one hectare 1800-2700 kg of seed materials are required.

### Preparation of land

Plough or dig the land to a depth of 15-20 cm. Prepare mounds at a spacing of 75 cm x 75 cm incorporating cattle manure @ 1 kg per mound.

### Manuring

The nutrient dose and schedule of application are the same as that of *D. alata*.

### Trailing

Trail the vines by fixing small poles attached with coir rope and direct 4-6 plants per pole.

### Harvesting

The crop is ready for harvest by about 7-8 months time. Tuber yields of 20-25 t ha<sup>-1</sup> can be obtained by following the improved methods of cultivation.

### 3. WHITE YAM (*Dioscorea rotundata*)

White yam or African yam is a new crop species of edible yam introduced from Nigeria.

#### Varieties

**Sree Subhra:** The tuber contains 27-28 per cent dry matter, 21-22 per cent starch and 1.8-2 per cent protein. It is drought tolerant with 9-10 months duration.

**Sree Priya:** The tuber contains 25-27 per cent dry matter, 19-21 per cent starch and 2-2.5 per cent protein. It is drought tolerant and duration is 9-10 months. It is suitable for inter-cropping in mature coconut garden and with banana.

**Sree Dhanya:** It is the first dwarf variety. The tubers have 28-30 per cent dry matter, 22-24 per cent protein and 0.3-0.5 per cent sugar.

#### Manuring

FYM 15 t ha<sup>-1</sup> to be applied at the time of land preparation followed by application of NPK fertilizers @ 100:50:100 kg ha<sup>-1</sup>. Full dose of P fertilizer along with 50 per cent of N and K fertilizers to be applied as basal when 50 per cent of the planted setts sprouts. The balance 50 per cent of N and K fertilizers to be applied as top dressing, 1 month after the first application which could be combined with intercultural operations.

Rapid seed yam production (minisetts technique)

In this method clean and healthy yam

tubers weighing about 1 kg are cut into cylindrical (disc-like) pieces, each about 5 cm thick. From each such piece, 2-4 small pieces (30 g) could be obtained by cutting the disc longitudinally or along the two perpendicular diameters. Such a piece is called a "minisetts". The minisetts are then spread out under light shade for an hour with cut surface facing up before planting them in the nursery seed beds. The minisetts take 2-3 weeks for sprouting. At this stage, they are transplanted to the main field at a spacing of 50 cm on ridges taken 1 m apart.

Organic Farming of Yams (Greater Yam, Lesser Yam, White Yam & Dwarf White Yam)

Use of organically produced planting materials, application of FYM @ 15 t ha<sup>-1</sup> in pits at the time of planting (1.5 kg plant<sup>-1</sup>), application of neem cake @ 1 t ha<sup>-1</sup> in pits at the time of planting (80 g plant<sup>-1</sup>), application of biofertilizers, *Azospirillum* @ 3 kg ha<sup>-1</sup>, *mycorrhiza* @ 5 kg ha<sup>-1</sup> and 1 phospho bacteria @ 3 kg ha<sup>-1</sup> (for dwarf white yam *Azospirillum* @ 3 kg ha<sup>-1</sup> and *mycorrhiza* @ 5 kg ha<sup>-1</sup>), inter-sowing of green manure cowpea (seed rate @ 20 kg ha<sup>-1</sup>) between yam mounds and incorporation of green matter at 45-60 days (green matter addition from the green manure @ 15-20 t ha<sup>-1</sup>), application of ash @ 1.5 t ha<sup>-1</sup> at the time of incorporation of green manure in pits (250 g plant<sup>-1</sup>).

### SWEET POTATO (*Ipomoea batatas*)

Sweet potato requires a warm humid tropical climate with a mean temperature of about 22°C. Though sensitive to frost, it can also be grown in the hills up to an altitude of

1500-1800 m as a summer crop. Under rainfed conditions the crop requires a fairly well distributed annual rainfall of 75-150 cm. Being a photosensitive crop, sunny days and cool

nights are favourable for better tuber development.

The crop can be grown on a variety of soils having good drainage, but grows best in fertile sandy loam soils. Heavy clayey and very light sandy soils are not suitable for proper tuber development.

Season

Rainfed crop: June-July,  
September- October

Irrigated crops: October-November  
(for uplands) and January-  
February (for low lands)

Varieties

Improved varieties: H-41, H-42, Sree Nandini, Sree Vardhini, Sree Rethna, Sree Bhadra, Kanjanghad, Sree Arun, Sree Varun and Sree Kanaka.

H-41 - Variety with excellent cooking quality, sweet tubers and duration of 120 days.

H-42 - Variety with excellent cooking quality, sweet tubers and duration of 120 days.

Sree Nandini - Early maturing, drought tolerant variety with 100 - 105 days duration and suited as catch crop in paddy fallows.

Sree Vardhini - Early maturing, carotene rich variety for food and feed with a duration of 100 - 105 days.

Sree Rethna - Early maturing, carotene rich orange fleshed variety with 90 - 105 days duration.

Sree Bhadra - Early maturing, (90 days), trap crop for nematodes.

Sree Arun } - Early maturing, (90 days),  
Sree Varun } - highly palatable varieties.

Sree Kanaka - Short duration (75 - 85 days) with very high carotene (8.8 - 10 mg/100 g).

Kanjanghad - KAU variety obtained through selection and duration of 105 - 120 days.

Local varieties: Badrakali Chuvala, Kottayam Chuvala, Chinavella, Chakaravalli, Anakomban.

Seeds and sowing

Sweet potato is propagated by means of vine cuttings. To obtain vine cutting, raise nurseries from selected tubers using the following method. 80 kg of medium sized weevil free tubers (each of 125-150 g) are required for planting in the primary nursery area (100 m<sup>2</sup> to plant one hectare).

Plant the tubers at a spacing of 30-45 cm on ridges formed at 60 cm apart and replant in secondary nursery of about 500 m<sup>2</sup> area at a spacing of 25 cm. Apply urea 15 days after planting @ 1.5 kg/100 m<sup>2</sup> in the primary nursery. To ensure better plant growth in the secondary nursery, 5 kg of urea has to be applied in two split doses on 15<sup>th</sup> and 30<sup>th</sup> day after planting. Vines obtained from the freshly harvested crop are also planted in similar nursery area to obtain sufficient planting material. Cuttings obtained from the apical and near apical portions of the vines are preferable for planting in the main field. Storing of cut sweet potato vines with intact leaves, in bundles covered with banana leaves (dipped in water) and kept under shade for two days prior to planting is recommended. Irrigate the nursery every alternate day during the first 10 days and once in 10 days, thereafter. Vines will be ready for planting on the 45<sup>th</sup> day.

In the main field, plant vine cutting of 20-25 cm length on ridges 60 cm apart and at a spacing of 15-20 cm between the vines. The cuttings can also be planted on mounds taken at a spacing of 75 cm x 75 cm. On the top of each mound, 3-6 cuttings can be planted. Plant the vine cuttings with the middle portion buried deep in the soil and the two cut ends exposed to the surface. Ensure sufficient moisture in

the soil for early establishment of the cutting. Provide adequate drainage and prevent water logging.

#### Land preparation

Make the soil to a fine tilth by ploughing or digging to a depth of 15-25 cm. Make ridges 25-35 cm high, 60 cm apart for planting vines.

#### Manuring

Apply cattle manure or compost @ 10 t ha<sup>-1</sup> at the time of preparation of ridges. The recommended N:P<sub>2</sub>O<sub>5</sub>:K<sub>2</sub>O dosage for sweet potato is 75:50:75 kg ha<sup>-1</sup>. For the reclaimed alluvial soils of Kuttanad, the recommendation is 50:25:50 kg ha<sup>-1</sup>. Apply N in two equal split doses, the first at the time of planting and the second 4-5 weeks after planting. Apply full dose of P<sub>2</sub>O<sub>5</sub> and K<sub>2</sub>O at the planting time.

#### Irrigation

When grown as irrigated crop, provide irrigation once in 2 days for a period of 10 days after planting and thereafter once in 7-10 days. Stop irrigation 3 weeks before harvest. But one more irrigation may be given 2 days before harvest. IW / CPE for higher tuber yield in non-rainy periods is 1.2 (approximate interval of 11 days). The application of N and K<sub>2</sub>O @ 50 kg ha<sup>-1</sup> is recommended for the crop grown under irrigation.

#### After cultivation

Conduct two weeding and earthing up operations about 2 weeks and 5 weeks after planting. The top dressing of fertilizers may be done along with the second after cultivation. Prevent development of small slender tubers at the nodes by turning the vines occasionally during active growth phase.

#### Rotation and mixed cropping

Under irrigated conditions, sweet potato can be rotated with rice and planted during December-January after harvest of the second crop of rice. As a mixed crop, it can be grown along with colocasia, elephant foot yam etc. Under rainfed conditions, green manure crops such as kozhinjil and sunnhemp can be grown after harvest of the sweet potato and later incorporated into the soil at the time of land preparation for the succeeding crop.

#### Plant protection

##### Integrated control of sweet potato weevil

- Remove and destroy the crop residues of the previous crop.
- Use healthy and weevil-free planting materials.
- Apply *Chromolaena odorata* leaves as mulch @ 3 t ha<sup>-1</sup> at 30 DAP.
- Trap adult weevils using sweet potato pieces (of about 6 cm diameter) of 100 g size, kept at 5 m apart during 50 to 80 DAP at 10 days interval. Tubers may be cut and kept inside wire cages to avoid rat damage.
- Use pheromone traps (3Z dodecenyl 2E butenoate).

#### Harvesting

The duration of the crop depends on the variety; but in general, the crop can be harvested in about 3.5 - 4 months after planting. Harvest the crop when leaves begin to turn yellow and the tubers mature. The maturity of tuber can be ascertained by cutting fresh tubers. The cut surface will dry clear if the tuber is mature and becomes dark green if immature. Harvest the crop by digging out the tubers without causing injury.

## TAPIOCA [CASSAVA] (*Manihot esculenta*)

Tapioca grows and produces best under warm humid tropical conditions where rainfall is well distributed and fairly abundant. It can also be grown under irrigation where rainfall is low. Its outstanding characteristic in terms of moisture requirement is the ability to withstand fairly prolonged periods of drought. However, at the time of planting there must be sufficient moisture for the plant to establish itself. The crop cannot withstand cold and is killed by frost.

The crop grows well in well-drained laterite, gravelly and sandy loam soils. Heavy and rocky soils are less suitable because they restrict root development. The crop cannot survive waterlogged conditions and in such areas, it must be planted on mounds or ridges that permit drainage. The crop can also be grown on hill slopes with precautions and on wastelands of low fertility.

### Season

The main planting seasons are April-May with the onset of southwest monsoon and September-October with the onset of north-east monsoon. Planting can also be done during February-April, provided sufficient moisture is made available through irrigation. For maximum tuber production, April-May planting is preferred because the crop can effectively utilize both the monsoons. The second best season is September-October.

### Varieties

H-97: This is a semi-branching variety, tolerant to mosaic disease with duration of 10 months. But the harvest can be prolonged even up to 16 months. The starch content is 30 per cent.

H-165: This is a non-branching type with poor cooking quality having eight months

duration. It is tolerant to mosaic but susceptible to wilt disease. The starch content is 24.5 per cent.

H-226: This is a semi-branching type with medium cooking quality having 10 months duration. It is moderately susceptible to mosaic. The starch content is 29 per cent.

M-4: This is an erect type with excellent cooking quality having 10 months duration. The starch content is 29 per cent.

Sree Visakhm: This is a semi-branching type with yellow coloured flesh having 10 months duration. It shows high tolerance to mosaic and low susceptibility to pests like red mites, scale insects, thrips etc. The starch content is 26 per cent and vitamin A 466 IU.

Sree Sahya: This is a predominantly semi-branching type with 10 months duration. It shows high tolerance to mosaic and low susceptibility to pests like red mites, scale insects, thrips etc. The starch content is 30 per cent.

Sree Prakash: This has seven months duration and the yield potential is 30-40 t ha<sup>-1</sup>.

Kalpaka: This is a non-branching type with six months duration and is suited as an intercrop of coconut in reclaimed alluvial soils of Kuttanad.

Sree Jaya: This is an early variety with seven months duration and excellent cooking quality. Tuber contains 24-27 per cent starch and is low in cyanogens.

Sree Vijaya: This is an early variety with 6-7 months duration and excellent cooking quality. Tuber contains 27-30 per cent starch and is low in cyanogens.

**Sree Harsha:** This has 10 months duration and good cooking quality. Tuber contains 34-36 per cent starch. They are non-bitter and ideal for culinary purposes and the high starch content makes it suitable for preparing dried chips.

**Nidhi:** This is a high yielding early variety with 5.5-6 months duration. It is tolerant to mosaic and moisture stress. Tuber contains 26.8 per cent starch and 20 ppm HCN.

**Vellayani Hraswa:** High yielding early variety with 5-6 months duration. It cannot tolerate drought. The cooking quality is very good. Tubers contain 27.8 per cent starch and 53 ppm cyanogen.

**Sree Rekha:** It is a top cross hybrid with 10 months duration. Tubers contain 28.2 per cent starch with excellent cooking quality.

**Sree Prabha:** It is a top cross hybrid with 10 months duration. Tubers contain 26.8 per cent starch with good cooking quality.

#### Seeds and sowing

Tapioca is propagated by stem cuttings. Select mature healthy stems free from diseases or pests. Discard about 10 cm from the lower mature and about 30 cm from the upper immature end. Stems should be cut into setts of 15-20 cm length using a sharp knife. About 2000 stems are required for planting one hectare. Harvested stems are to be stored vertically in shaded and well-aerated places. Spraying dimethoate (0.05 per cent) on the stem will control scale insects.

Pit, flat, ridge or mound method of planting can be adopted depending upon soil type, topography of land and elevation so that waterlogging is avoided. Pit followed by mound is found to be the best method of planting. Plant the cuttings vertically after smoothening the

lower cut end, at a depth not exceeding 4-6 cm. Adopt square method of planting at a spacing of 90 cm x 90 cm @ one cutting per pit. It is preferable to adopt 75 cm x 75 cm spacing for non-branching varieties like M-4.

Gap filling should be done within 15 days after planting preferably with longer setts of 40 cm length. Sree Visakhm is a choice variety recommended as an intercrop in coconut gardens. Optimum plant population is 8000 plants per ha with 90 cm x 90 cm spacing.

#### Land preparation

Before planting, plough the field 2-3 times or dig to a depth 25-30 cm depending upon soil type to establish a deep porous field in which the setts are to be planted.

#### Minisett planting technique for quality planting material

For producing minisetts, mature, disease free stems preferably those obtained from indexed meristem culture should be selected. Two node cuttings are taken from these stems using a sharp hack-saw. Top one-third portion is usually discarded in the traditional system, however in the minisett technique, it is fully utilized. The tip of the stem (about 5 to 6 cm long) is carefully cut without causing damage. For preventing dehydration, it is advisable to place the tip cuttings in water. The stem just below the growing tip is very tender with prominent axillary buds. Hence, from this portion, cuttings with four nodes are taken instead of two as the latter may easily get dried up.

#### Preparation of nursery:

Select an area with well drained soil and irrigation facility. Shade net house of 35 per cent shade is ideal for the germination and growth of minisetts. Mark out the length

and breadth and make raised beds of soil : sand mixture in equal proportion. The beds could be of convenient length and width not exceeding 1 m. An area of 220 m<sup>2</sup> nursery is required for producing minisetts for planting one hectare of land. Two node cuttings are planted end to end horizontally, about 5 cm deep inside the soil, with the buds facing either sides. Tip cuttings and four node top setts should be planted erect at 5 cm x 5 cm spacing to prevent decay due to excess moisture in these tender parts. Minisetts would sprout in a week's time. Mosaic virus infected plants, if any found, should be rogued off as soon as such symptoms are expressed, to keep the nursery disease free. The minisetts will be ready for transplanting in about three to four weeks time. After the basal application of recommended manure in the main field, ridges of 30 cm height are taken with a spacing of 45 cm between the ridges and planting is done on the ridges at a spacing of 45 cm. Multiplication ratio by this process is enhanced to 1: 60 as against the traditional method 1:10.

#### Manuring

Cattle manure or compost may be applied at 12.5 t ha<sup>-1</sup> during the preparation of land or while filling up the pits so as to provide about 1 kg of organic manure per plant. Apply N:P<sub>2</sub>O<sub>5</sub>:K<sub>2</sub>O (kg ha<sup>-1</sup>) at the rates shown below:

H-97 and H 226 :	75 : 75 : 75
H-165, Sree Visakhm, Sree Sahya:	100 : 100 : 100
M-4 and local:	50 : 50 : 50

N and K<sub>2</sub>O may be applied in three split doses, i.e., 1/3 basal, 1/3 two months after planting and 1/3 three months after planting. Dose of P<sub>2</sub>O<sub>5</sub> can be reduced to half where the crop is grown for more than 3 years under

full dose of recommended fertilizers, since under such situation there would be build up of soil P.

For August-September planted tapioca, apply half N, full P<sub>2</sub>O<sub>5</sub> and half K<sub>2</sub>O basally with first digging and weeding. The remaining quantity of N and K<sub>2</sub>O may be applied 45 days after planting at the time of intercultivation.

In the acid soils of Kerala, 50 per cent of K requirement can be substituted by NaCl.

Note: N:P<sub>2</sub>O<sub>5</sub>:K<sub>2</sub>O @ 50:50:100 kg ha<sup>-1</sup> is recommended for Sree Visakhm when grown as an intercrop in coconut garden. Higher levels of N tend to increase HCN content of the tubers.

Soil application of Mg as MgSO<sub>4</sub> @ 20 kg ha<sup>-1</sup> (1.62 g plant<sup>-1</sup>) and Zn as ZnSO<sub>4</sub> @ 12.5 kg ha<sup>-1</sup> (1g plant<sup>-1</sup>) in small channels around the mounds within 2 months of planting cassava providing an interval of 2 weeks between the application of these fertilizer enhances tuber yield and quality. When they are used continuously, their application rates can be fixed based on their status in the soil following Table 14.

#### After cultivation

Keep the field free of weeds and maintain soil loose by 2-3 shallow diggings or hoeing upto 90 days after planting followed by light earthing up. Retain two shoots on each plant in opposite directions and remove excess shoots about 30 days after planting.

#### Irrigation

Under conditions of well-distributed rainfall, tapioca grows well as a rainfed crop and irrigation is not necessary. However, the crop has to be irrigated to provide sufficient moisture



Table 14. Application rate of Mg and Zn based on their status in the soil

Soil Mg status		Rate of application of MgSO <sub>4</sub>	Soil Zn status		Rate of application of ZnSO <sub>4</sub>
meq 100g <sup>-1</sup>	kg ha <sup>-1</sup>	kg ha <sup>-1</sup>	µg g <sup>-1</sup>	kg ha <sup>-1</sup>	kg ha <sup>-1</sup>
0.0-0.25	0-67	20.0	<0.2	<0.45	12.5
0.25-0.50	67-134	15.0	0.2-0.3	0.45-0.67	10.0
0.50-0.75	134-201	10.0	0.3-0.4	0.67-0.90	7.5
0.75-1.00	201-268	5.0	0.4-0.6	0.90-1.34	5.0
>1.00	>268	2.5	>0.6	>1.34	2.5

under conditions of prolonged dry periods after planting. When the crop is grown under irrigation, yield increase of 150-200 per cent over the rainfed crop has been observed.

Furrow irrigation with 25 mm water at 100 mm CPE and alternate furrow irrigation with 50 mm water at 75 mm CPE require only less water and labour for optimum yield. Approximate irrigation interval schedules will be 27 and 20 days respectively in summer months.

#### Intercropping in tapioca

Tapioca is planted at a spacing of 90 cm x 90 cm and it takes about 3-3.5 months time to have enough canopy to cover the land. So it is possible to have an intercrop of groundnut during the early stages of tapioca crop. Bunch varieties like TMV-2, TMV-7, TG-3, TG-14 and Spanish Improved are preferred for intercropping in tapioca. The best season for sowing groundnut is May-June. Immediately after planting of tapioca sets, groundnut seeds are sown at a spacing of 30 cm between rows and 20 cm within rows, so that two rows of groundnut can be accommodated in between two rows of cassava. A seed rate of 40-50 kg ha<sup>-1</sup> is recommended for dibbling one seed per hill. Only well-matured and bold seeds are to be

selected for sowing. In acid laterite soils of Kerala, apply 1000 kg ha<sup>-1</sup> of lime as basal dressing. A basal dose of 50:100:50 kg N:P<sub>2</sub>O<sub>5</sub>:K<sub>2</sub>O per ha should be given uniformly to both the crops. One month after sowing of the seed, 20 kg each P<sub>2</sub>O<sub>5</sub> and K<sub>2</sub>O and 10 kg N / ha<sup>-1</sup> may be given to the intercrop along with earthing up. Once pod formation has started (i.e., 40-45 days after sowing) the soil should not be disturbed, as it will affect the pod development adversely. The groundnut crop matures in 105 to 110 days. After the harvest of pods, the haulms are incorporated in the soil along with a top dressing of 50 kg each of N and K<sub>2</sub>O per ha for the main crop. By adopting this practice, 20-25 per cent additional income can be obtained.

In sandy areas intercropping tapioca with cowpea / groundnut / black gram / green gram may be recommended giving a spacing of 20 cm on both sides of the ridges. The non-trailing grain cowpea variety V-26 is recommended as a companion crop along with tapioca. For a pure crop of tapioca or for a cropping system involving tapioca as the main crop and the pulse crop suggested above, the field may be irrigated once in 36 days to a depth of 5 cm. This recommendation is for shallow water table situations. For deep water table situations, the crop may be irrigated once in 24 days to a depth of 5 cm.

## Plant protection

### Cassava mosaic disease (CMD)

The disease is transmitted by a white fly *Bemisia* sp. As a rule, only stem cuttings from disease free plants should be used for planting to minimize the spread of the virus disease. For this purpose, tagging of disease free healthy plants for selection as planting materials must be practised from September to December. All plants showing even very mild symptoms must be rejected. Mosaic tolerant varieties such as H-97 may be used to minimize economic loss of tubers.

### Production of disease free planting material of tapioca through nursery techniques

Setts of 3 to 4 node cuttings from apparently disease free plants are collected and planted in the nursery at a very close spacing of 4 x 4 cm so that about 500 setts can be accommodated in one square metre land. Daily watering of the setts has to be done for the first 10 days and on alternate days afterwards. Screening of CMD symptoms may be started 10 days after planting. Setts showing even mild symptoms are to be removed and burnt. This must be continued up to 20-25 days, by that time healthy seedlings can be transplanted to the main field. Supplementary irrigation may be given in the transplanted field till they get established. Screening for disease symptoms and roguing of infested plants may be continued in field at weekly intervals upto harvest. The selected healthy stems are again cut into minisetts and subjected to nursery and field screening. By adopting this technique it is possible to produce healthy plants.

### Leaf spot

Spray 1 per cent Bordeaux mixture for control of leaf spot.

### Bacterial blight

Bacterial blight is a disease noted in severe proportion in certain parts of Kerala. Chemical control is not effective. Use of resistant or tolerant varieties is the only method of control. Among improved varieties, H-97, H-226, H-1687 and H-2304 are tolerant to the disease while H-165 is highly susceptible. Among the local varieties, M-4, Paluvella, Pichivella, Parappilappan, Anamaravan etc. are tolerant to the disease.

### Red spider mites and scale insects

Red spider mites in the field and scale insects under storage are important pests of tapioca. Under field conditions light infestation of mites can be controlled effectively by spraying the crop with water at 10 days interval from the onset of mite infestation. In the case of very severe infestation, the crop can be protected by spraying 0.05 per cent dimethoate at monthly intervals from the time of appearance of mites.

The stem may be sprayed with 0.05 per cent dimethoate before storing as a prophylactic measure against the scales.

### Termites

To control termites infesting planted setts, sprinkle chlorpyrifos in the mounds prior to planting.

### Management of storage pests of cassava

Treating chips with granular salt (3 per cent), sun drying thoroughly and storing in gunny bags in godown are very effective against *Araecerus fasciculatus* and *Sitophilus oryzae*.

### Harvesting

Tapioca becomes ready for harvest 9-10 months after planting. Hybrid varieties like H-226, H-97 and H-165, when grown under recommended management practices have recorded yields up to 40-50 t ha<sup>-1</sup> of raw tuber.

## COLEUS (*Solenostemon rotundifolius*)

Coleus thrives well in tropical and subtropical regions. A well-drained medium fertile soil is suitable for its cultivation.

### Season

Plant the cuttings in the main field between July and October.

Variety: Nidhi, Sree Dhara and Suphala.

Sree Dhara - First variety in chinese potato with good cooking quality and 5 months duration.

Nidhi - Variety released from RARS, Pattambi with 5 months duration.

Suphala - A tissue culture mutant derived by KAU from local cultivar suited for year round cultivation with a duration of 120 - 140 days.

### Nursery

Raise the nursery approximately one month before planting. An area of 500 to 600 m<sup>2</sup> is sufficient to produce cuttings required for one ha of main field. Apply 125 to 150 kg FYM in the nursery area. Plant the seed tubers at a spacing of 15 cm on the ridges taken 30 cm apart. About 170 to 200 kg of tubers is required to raise the nursery. Take the vine cutting to a length of 10-15 cm from the top portion after three weeks from planting.

### Preparation of main field

Plough or dig the land to a depth of 15-20 cm and form ridges 30 cm apart or raised beds of 60-90 cm width.

### Planting

Plant the vine cutting collected from the nursery on ridges at a spacing of 30 cm or on raised beds at 30 cm x 15 cm spacing.

### Manuring

Broadcast 10 tonnes of FYM and N:P<sub>2</sub>O<sub>5</sub>:K<sub>2</sub>O @ 30:60:50 kg ha<sup>-1</sup> and incorporate into the soil at the time of land preparation. Topdress with N and K<sub>2</sub>O at the rate of 30 and 50 kg ha<sup>-1</sup> respectively at 45 days after planting.

### After cultivation

Give weeding and earthing up, at 45 days after planting along with topdressing. Cover a portion of the vine with soil to promote tuber formation.

### Plant protection

To control the root-knot nematode, deep plough the field in summer; adopt crop rotation and destroy root residues and other plant parts by burning.

### Harvesting

Harvest the crop 5 months after planting.

## COMMERCIAL CROPS

### CASHEW (*Anacardium occidentale*)

Cashew is adapted to warm humid tropical conditions. It can be grown in almost all types of soils from sandy to laterite and up to an elevation of 600-700 m including wastelands of low fertility. It grows and yield best in well-drained red sandy loams and light coastal sands. Heavy clay soils, poor drainage conditions, very low temperature and frost are unsuitable for the crop.

#### Planting materials

Cashew can be propagated by seedlings, air layers and softwood grafts. Since it is a cross-pollinated crop, vegetative propagation is recommended to obtain true to type progeny. Field establishment of air layers have been found to be poor. Hence softwood grafts, which give a high rate of establishment and early flowering, are recommended for planting (Table 15).

Table 15. Cashew varieties

Varieties / hybrid / types	Mean yield (kg/tree/year)	Nature of bearing
Anakkayam-1 (BLA 139-1)	12.00	Early
Madakkathara-1 (BLA 39-4)	13.80	Early
Vridhachalam-3 (M26/2)	11.68	Early
Kanaka (H-1598) (BLA 139-1 x H3-13)	12.80	Mid
Dhana (H-1608) (ALGD 1-1 x K 30-1)	10.66	Mid
K-22-1 (Selection from K22)	13.20	Mid
Dharasree (H-3-17) (T 30 x Brazil 18)	15.02	Mid
Priyanka (H-1591) (BLA-139-1 x K30-1)	16.90	Mid
Amrutha (H-1597) (BLA-139-1 x H3-13)	18.35	Mid
Anagha (H8-1) (T 20 x K30-1)	13.73	Mid
Akshaya (H7-6) (H4-7 x K30-1)	11.78	Mid
Madakkathara-2 (NDR 2-1)	17.00	Late
Sulabha (K10-2)	21.90	Late
Damodar (H1600) (BLA 139-1 x H3-113)	13.36	Mid
Raghav (H1610) (ALGD 1-1 x K 30-1)	14.65	Mid
Poomima (BLA 139-1 x K 30-1)	14.08	Mid
Sree (Selection from Anakkayam-1)	23.78	Early

## 1. Propagation by seedlings

### Selection of mother trees

Select mother trees having the following characteristics: (1) Good health, vigorous growth and intensive branching habit with panicles having high percentage of hermaphrodite flowers. (2) Trees of 15-25 years of age. (3) Bearing nuts of medium size and weight (5-8 g/nut) with an average yield of 15 kg nuts per annum. (4) Bearing 7-8 nuts per panicle.

### Selection of nuts

Select mother trees in February and collect seed nuts in March-April. Select good, mature, medium sized nuts, which sink in water as seeds after drying in sun for two to three days.

### Raising seedlings

Raise seedlings in polythene bags during May. Use polythene bags of size 20 cm x 15 cm and fill the bags with garden soil, leaving a gap of 1 to 1.5 cm above. Soak seed nuts in water for 18 to 24 hours to hasten germination. Sow the pre-soaked seed nuts in polythene bags filled with garden soil at a depth of 2-3 cm with the stalk end up. Seeds germinate in seven to ten days.

## 2. Propagation by air layering

Prepare air layers during February-March, so that they will be ready for planting in June-July. Select 9-12 months old pencil-thick terminal shoots. Remove carefully a strip or ring of bark, 0.6 to 1.2 cm thick by using a sharp knife without injuring the underlying wood. Wind a string around the cut area and cover it with moist moss or wood shavings or sand and saw dust mixture or ordinary potting mixture and wrap round with 150-200 gauge

polythene film of size 23 cm x 15 cm. Secure loose ends of film with jute fibre. When roots emerge from the ringed portion in 40-60 days, give a 'V' cut at lower end of treated shoot. After about 15 days, deepen the cut slightly. Cut and separate rooted shoot about 7 days later. Pot the layers immediately after separation from the tree into containers of size 15 x 15 cm made from coconut husk and keep them in shade. Avoid excessive watering. Plant the layers along with the container in the prepared pits with the onset of southwest monsoon. Provide shade and mulch with dry leaves to reduce sun-scorch in tender plants. It is advisable to defoliate the layers two weeks before separation from the mother plant.

## 3. Propagation by grafting / budding

Different methods of grafting viz., epicotyl grafting, softwood grafting, veneer grafting, side grafting, patch budding etc. have been tried in cashew with varying degrees of success. Among them, softwood grafting was found to be the best for commercial multiplication of cashew.

### Softwood grafting

#### Selection of seed nuts

(1) Seed nuts may be collected during the peak period of harvest (February-March) and sun-dried for 2-3 days. (2) Quality seed nuts may be selected by immersing in water or 10 per cent saline solution. Seeds, which sink in water, may be selected. (3) Medium sized nuts (7-9 g) may be selected to get vigorously growing seedlings.

### Raising rootstocks

1. Fresh seed nuts are to be used for raising rootstock. Seed nuts stored for more than one year may be avoided.

2. The seed nuts should be soaked in water overnight before sowing.
3. Use polythene bags (size 25 cm x 15 cm, 300 gauge thickness) for filling potting mixture.
4. Punch about 16-20 holes on the polythene bags to ensure good drainage.
5. Prepare the potting mixture (1:1:1 ratio of red soil, river sand and compost) mixed with rock phosphate @ 5 g per 2 kg potting mixture.
6. Fill the polythene bags up to the brim of the bag.
7. Sow the pre-soaked nuts in the centre of the bag with stalk end up, at a depth of 2.0-2.5 cm.
8. Water the bags immediately after sowing and daily thereafter. Avoid excess irrigation.
9. Nuts usually germinate within 15-20 days after sowing during monsoon months and within 8-10 days during dry months.
10. Nuts should be sown at weekly intervals to get continuous supply of rootstocks.
11. During summer, provide partial shade to the seedlings till they change their bronze colour to green and then keep them in the open.
12. The seedlings will be ready for grafting in 50-60 days after germination.
13. Prevent damage to germinating nuts from squirrels, birds etc.
14. During the rainy season, damping off of young seedlings is common. To control this disease, spraying / drenching Bordeaux mixture (1 per cent) is effective.

#### Selection of rootstock

Select 50-60 days old healthy seedlings having single main stem grown in the centre of the polythene bag, as rootstock.

#### Selection of scions

(1) Select a high yielding variety of cashew as mother plant to collect adequate number of scions. (2) Select 3-5 month old non-flowering lateral shoots of current season's growth. (3) The selected scions should be 10-12 cm long, straight, uniformly round and pencil thick with brown colour having dormant plump terminal bud. The top 4-5 leaves should be dark green in colour indicating proper maturity of the scion.

#### Pre-curing

- (1) Pre-cure the selected scions by clipping off three fourth portion of leaf blades.
- (2) Scions will be ready for grafting in 7-10 days after leaf removal.

#### Collection of scions

(1) The pre-cured scions are to be cut early in the morning to avoid desiccation. (2) The scions should be collected before the terminal buds sprout. (3) Wrap scions in moist cloth and put in polythene covers as soon as they are cut from the mother tree and bring them to the nursery for grafting. If necessary, they can be stored for 3-4 days and used for grafting.

#### Preparation of rootstock

(1) Retain two pairs of bottom leaves and remove others from the selected seedlings using a sharp knife. (2) Give a transverse cut on the main stem, 15 cm above ground level. (3) A cleft of 4-5 cm deep is made in the middle of the decapitated stem of the seedling by giving a longitudinal cut.

#### Preparation of scion

(1) Select a matching scion stick (same thickness as that of the rootstock). (2) The cut end of the scion is shaped to a wedge of 4-5 cm long by chopping the bark and wood from two opposite sides.

### Grafting

1. The wedge of the scion is inserted into the cleft of the rootstock, taking care to ensure that the cambium layers of stock and scion are in perfect contact with each other.
2. The graft joint is secured firmly by a polythene tape (1.5 cm wide and 30 cm long).
3. The scion of the graft is to be covered with a wet polythene cap (15 cm x 12.5 cm, 100 gauge thickness) and tied at the bottom to maintain humidity inside and to protect the apical bud from drying. The polythene cap should not touch the terminal bud. A narrow polythene cover of size 20 cm x 3 cm (sip-up-cover) can also be used instead of above said polythene cap.
4. The grafted plants are to be kept under shade for 10-15 days to enable sprouting of the terminal buds.
5. The polythene caps are to be removed and the grafts shifted to open place. The successful grafts show signs of growth within 3-4 weeks after grafting.
6. The grafts will be ready for planting 5-6 months after grafting.
7. The success in softwood grafting is more during the period from March to September under Kerala conditions.

### Care in the nursery

1. The grafts are to be watered regularly using a rose can or micro-sprinkler.
2. Remove new sprouts emerging from rootstock at frequent intervals.
3. Panicles, if produced by the grafts, may be removed as and when observed.
4. Grafts should be placed on polythene sheets spread on the ground to prevent rooting.
5. Shift the grafts frequently from one place

to another to prevent them from striking roots into the ground.

6. Spray recommended insecticides for controlling the infestation of sucking insects as and when required.

### Graft production under polyhouse

Softwood grafts can be prepared almost throughout the year with a mean graft success of about 60-70 per cent. Higher success is achieved during the monsoon season. For this, low cost polyhouses (prepared from casuarina/bamboo poles/areca reapers / GI pipes/PVC pipes and covered with high density polythene sheet of convenient dimensions) preferably 20 m long and 6 m wide may be utilized for graft production. The height of the polyhouse should be 2.5 m in the middle and 1.0 m on both sides. The plants may be watered using hose. Misting units can also be fitted at appropriate points and switched on for about 5-10 minutes at an interval of two hours from 10 a.m. to 6 p.m. during summer season. This reduces the temperature build up inside the polyhouse. Raising of rootstock seedlings, grafting of rootstocks and maintenance of grafts can be done inside the polyhouses. These polyhouses give protection to the seedlings and grafts during heavy rains and reduce the mortality. Again during summer months the seedlings/grafts can be maintained in these polyhouses by covering with HDPE shade nets (35-50 per cent shade).

### Planting and management of grafts

The softwood grafts will be ready for planting in 5-6 months after grafting. The pits are filled with topsoil and 5-10 kg of compost or dried cowdung / pit and the grafts are planted after carefully removing the polythene bags. Care should be taken while planting to see that the graft union is 2.5 cm above the ground level. The polythene tape is to be carefully cut and removed subsequently. Staking should be done immediately after planting to avoid lodging.

### Planting and management of plantation

Plant softwood grafts in pits of size 50 cm x 50 cm x 50 cm during June-July.

Planting may be done at a spacing of 7.5 m for poor and 10 m for rich and deep soils and sandy coastal area. On very sloppy lands, the rows may be spaced 10-15 m apart with a spacing of 6-8 m between trees in a row.

Depending upon the weed growth, weeding operation may be done during August-September. Mulch the plant base with dry leaves to reduce sun-scorch to tender plants.

Herbicides can be used for controlling weeds. Apply glyphosate 0.8 kg ai/ha<sup>-1</sup>, once in June-July.

### Initial training / shape pruning

The sprouts coming from the rootstock portion of the graft, that is from the portion below the graft joint, should be removed frequently during the first year of planting. Initial training and pruning of young cashew plants during the first 3-4 years is essential for providing proper shape. Thereafter, little or no pruning is necessary. The plants should be allowed to grow by maintaining a single stem up to 0.75-1.00 m from ground level. This can be achieved by removing the side shoots or side branches gradually as the plants start growing from the second year of planting. Weak and criss-cross branches can also be removed. Branches growing unwidely may also be cut off. Proper staking of the plants is required to avoid lodging due to wind during the initial years of planting. Initial training and pruning of cashew plants facilitate easy cultural operations such as terrace making, weeding, fertilizer application, nut collection and plant protection. The flower panicles emerging from the grafts during the first and second year of planting should also be removed

(de-blossoming) in order to allow the plant to put up good vegetative growth. The plants are allowed to flower and fruit only from the third year onwards.

### General pruning

In older cashew plantations, removal of dried or dead wood, criss-cross branches, water shoots etc. should be attended to at least once in 2-3 years. This allows proper growth of the canopy and receipt of adequate sunlight on all the branches. Pruning of cashew plants should be done during May / June.

### Manuring

A fertilizer dose of 750 g N, 325 g P<sub>2</sub>O<sub>5</sub> and 750 g K<sub>2</sub>O per plant is recommended for cashew. Apply 1/5<sup>th</sup> dose after the completion of first year, 2/5<sup>th</sup> dose during second year and thus reaching full dose from 5<sup>th</sup> year onwards. Broadcast the fertilizer within an area of 0.5 to 3.0 m (15 cm deep) around the tree and incorporate by light raking.

### Intercropping

Pineapple is the most profitable intercrop in cashew plantation in the early stages of growth. It can be planted between two rows of cashew in trenches opened across the slope. Paired row of pineapple suckers can be planted in each trench at 60 cm between rows and 40 cm between two suckers within the row. These trenches can be opened at 1 m between two rows of cashew. Ginger, lemongrass and tapioca are also suitable as intercrops.

### High density planting

High density planting is a technique recommended for enhancing the productivity of cashew plantations. This technique involves planting more number of grafts per unit area and thinning at later stages. Instead of the normal planting density of 64 to 177 plants per hectare (spacing ranging from 7.5 to 10 m in the square system of planting) or 74 to 204



plants (spacing ranging from 7.5 to 10 m in the triangular system of planting), 312 to 625 grafts will be planted per hectare, initially. During later years, as the canopy develops, plant population is to be regulated by selective felling to minimize competition.

While adopting a high density planting technique, grafts may be planted initially at a spacing of 4 m x 4 m or 8 m x 4 m so that there will be 625 or 312 plants respectively. This population can be retained for a period of seven to nine or ten years depending upon the canopy expansion rate. If the soil is very rich the canopy development rate will be faster. High density planting would be more useful in poor soils where the rate of canopy expansion is slow. Considering the fertility status of the soil, the level of management in terms of fertilization, irrigation etc. the initial plant population is to be decided carefully for every agro-climatic condition. Later, after monitoring the canopy pressure between adjacent plants, the alternate plants are to be removed. Finally, when the plants attain full growth, the spacing between the plants will be 8 m x 8 m.

If uniform management practices are adopted, during early years of yield, the per tree nut yield will be more or less the same with all the trees, in both the conventional system of planting and in high density planting. But the per hectare yield will be more from high-density plantations (due to higher plant population) compared to the normal density plantations. During later years, when the plant population is equalized to that of normal density plantation, the productivity of both the plantations would be more or less the same. The bonus yield obtained during the early years of yield would be substantial in high-density plantations.

#### Top working

Top working is a technique evolved to rejuvenate unproductive and senile cashew trees. Top working can successfully rejuvenate poor yielders in the age group of 5-20

years. The unproductive trees are to be beheaded at a height of 0.75 to 1.00 m from ground level. The stem should be cut with a saw to avoid stump splitting. The best season for beheading trees is May-September. Soon after beheading, the stumps and cut portions should be given a swabbing with copper oxychloride and carbaryl 50 WP (50 g each per litre of water). Sprouts emerge 30-45 days after beheading. Sprouting will be profuse in young trees. New, 20-25 days old shoots should be grafted with scions of high yielding varieties using softwood grafting technique. To ensure at least six or seven successful grafts, 10-15 grafting are to be done on the new shoots of every tree. The best season for grafting is July-November. Thinning of the extra shoots arising from the stumps should be done to obtain better growth of the grafts. Removal of sprouts below the graft joint and removal of polythene strip from the graft joint should be done. Top working is simple and can be done by farmers after getting proper training.

The top worked trees start yielding right from the second year after top working. Thus precocity can be considered as one of the best advantages of this technique. The major disadvantage associated with top working is the huge casualty of trees due to stem borer attack. Intensive care and management to ward off stem borer is essential. As such, adoption of top working on a larger scale would be difficult.

#### Pest and diseases

##### Tea mosquito bug

This is the most serious pest affecting cashew. The pest usually appears with the emergence of new flushes and panicle. Drying of inflorescence and dieback of shoots are the symptoms. For control of tea mosquito bug, spray 0.05 per cent quinalphos or 0.003 per cent Lambda cyhalothrin or

thiamethoxam 25 WG 0.2 g/l. For organic cashew cultivation, pongamia oil @ 2 ml/l or *Beauveria bassiana* @ 20 g/l can be sprayed. A rational rotation of insecticides would be desirable to counteract the tendency of the pest to develop field resistance. Spraying may be done once, twice or thrice depending upon necessity.

First spraying is to be given synchronizing with the emergence of new vegetative flushes in October-November. The second spraying may be given synchronizing with the commencement of panicle emergence in December-January. The third spraying may be given at completion of flowering/initiation of fruit set in January – February.

Note: Avoid spraying 0.003 per cent Lambda cyhalothrin at the time of flowering, as it is highly toxic to honey bees.

#### Cashew stem and root borer (CSRB)

This is a serious pest, which is capable of destroying the cashew tree. Main symptoms of attack are yellowing of leaves, drying of twigs, presence of holes at the base of stem with exuding sap and frass.

Check regularly for symptoms of CSRB attack particularly during January – May period. In the case of already infested trees, mechanically remove various stages of pest (grubs and pupae) by carefully chiseling the bark. Care should be taken to avoid removal of more than 50 per cent of total bark circumference. Swab the chiseled area by using chlorpyrifos 20 EC (0.2 per cent @ 10 ml l<sup>-1</sup>) and drench the pesticide solution onto the soil near the root zone to minimize reinfestation by the pest.

Prophylactic treatment by swabbing the trunk region (up to 1 m height from the ground level) and exposed roots, with a suspension of mud slurry + coal tar and kerosene (1:2) or 5

per cent neem oil twice a year during March – April and November – December.

To reduce the spread of infestation, it is essential to remove the dead trees and trees in advanced stage of infestation at least once in 6 months. Dead trees and trees beyond recovery - trees having yellow canopy and/or more than 50 per cent bark circumference damage needs to be uprooted. Pest stages occurring in the roots should be destroyed so as to reduce pest inoculum in the future.

#### Dieback or pink disease

This disease is prevalent in cashew plantations during rainy season. Main symptom of attack is the appearance of white patches on branches followed by drying of twigs from the tip.

Chisel out the affected parts and apply Bordeaux paste. Give prophylactic sprays of 1 per cent Bordeaux mixture during May-June and October.

Note:

1. For grown up trees, 5 litres of spray fluid would be required at high volume discharge rate and 2.5 litres at the low volume discharge rate. For spraying, rocker sprayer with hi-tree lance is preferable.
2. For low volume application, the concentration of the insecticides is to be maintained at 0.1 per cent for quinalphos. It is difficult to cover the entire canopy with low volume equipment. In such cases, the uncovered upper canopy areas may be covered with rocker sprayer fitted with hi-tree lance system.
3. Dusting powder formulations are not recommended against tea mosquito bug.
4. Spray 0.003 per cent Lambda cyhalothrin as a prophylaxis against pest infestation in nursery plants.

5. Spray Bordeaux mixture 1 per cent to seedlings as a prophylactic measure against fungal diseases.
6. In anthracnose and tea mosquito endemic area following practices are recommended

Chemical (%)	Concentration	Time/ stage
Lambda cyhalothrin 0.003 % + Copper oxychloride 0.2 %	0.6 ml l <sup>-1</sup> 5 EC 2 g l <sup>-1</sup> (50 WP)	Flushing
Quinalphos 0.05 % + Mancozeb 0.2 %	2 ml l <sup>-1</sup> (25 EC) 2 g l <sup>-1</sup> (75 WP)	Flowering

#### Post Harvest Utilization of Cashew Apple

Cashew apple is a valuable source of sugars, minerals and vitamins especially vitamin C and can be used for preparation of various products.

#### Preliminary Processing

Select crisp, firm, tight and full colour developed best quality apples. It should have medium to large size, more than 70 per cent juice, more than 11 per cent sugar and 0.39- 0.42 per cent acidity. Since highly susceptible to physical injury and microbial spoilage, collect apples every day, after separating the nuts, when it falls to the ground. The selected fruits are washed with water.

Stainless steel or glass containers should be used for processing, after sterilization. Copper, iron, aluminum and brass containers should not be used as it will blacken the products. Plastic buckets or barrels can be used for dipping and cleaning fruits.

Juice can be extracted from ripe cashew apples, after washing, using screw press, basket press, hydraulic press or by hand pressing with the help of citrus juice extractor.

About 50-60 per cent raw juice with 9-10 per cent soluble solids can be obtained. The astringent taste of cashew apple is due to the presence of tannins in it. The tannin present in the raw juice can be removed through clarification by adopting one of the following methods:-

1. Take 5g powdered sago in minimum quantity of water, heat and make into paste by stirring and cool it. Add sago paste into one litre juice and mix well by stirring. Decant the clear juice after 12 hours.
2. Mix gelatin @ 0.5 g kg<sup>-1</sup> of raw juice and allow to settle. Decant the clear juice and discard the sediment (gelatin may be dissolved in water by heating).
3. Mix poly vinyl pyrrolidone @ 1.4 g kg<sup>-1</sup> of raw juice. Allow to settle and decant the clear juice.
4. Mix about 125 ml of fresh rice gruel (kanjivellam) and allow to settle. Decant the clear upper layer and repeat the process using 125 ml of rice gruel.

Tannin can be removed from mature or ripe apples (de-tanning) by adopting the following procedures:-

1. Detanning of ripe whole apples : Clean the apples and immerse in 5 per cent salt solution for 3 days with the change of salt solution daily. Take out the fruit on the 4<sup>th</sup> day and wash thoroughly in water. The fruit is now de-tanned.
2. Detanning of mature but unripe whole green apples for pickle preparation :

Wash the raw green fruit and cut into small pieces. Keep in 8 per cent salt solution for 3 days with the change of salt solution daily. Take out the fruits on the 4<sup>th</sup> day and wash

thoroughly with water. The fruit is now de-tanned.

#### Off - season storage of raw material

Raw material for cashew apple processing can be stored for a period of six months without affecting quality for the off - season preparation of products.

1. Juice for beverage production:- Mix 2.5 g potassium meta bisulphate (KMS) and 5 g citric acid during clarification of juice and store the clarified juice in food grade plastic containers.
2. Pulp for jam production:- Cook ripe cashew apple, after removal of tannin, for 20 minutes, make into pulp using pulper and mix with 2.5 g KMS and 5 g citric acid.
3. Cashew apple for pickle production:- Keep one kg of de-tanned green cashew apple pieces with 200 g salt in alternate layers.

Standard products like syrup, squash, ready-to-serve beverages etc. can be made using the clarified juice as per FPO specifications (Table 16).

#### Preparation of products

The recipe for the preparation of various products from cashew apple is given below:-

#### 1. Cashew apple juice

##### Ingredients

Cashew apple	-	25 kg
Poly Vinyl Pyrollidone	-	10 g
Sodium benzoate	-	6 g
Sugar	-	500 g
Citric acid	-	8 g

##### Preparation

Extract the juice by pressing. Clarify the juice by adding PVP and filter it through a muslin cloth. To the clarified juice, add all the items one by one under stirring.

##### Note:

1. Cashew apple juice can be blended with lime juice, orange juice or pineapple juice on 75:25 basis and served.
  2. The recovery of juice from apple can be improved by using basket press, screw press or hydraulic press.
- #### 2. Cashew apple squash

##### Ingredients

Cashew apple	-	25 kg
PVP	-	10 g
Sodium benzoate	-	6 g
Sugar	-	3 kg
Citric acid	-	100 g

##### Preparation

Wash cashew apple and extract the juice (8 litres). Clarify the juice by adding PVP and

Table 16. FPO specifications for fruit products

Products	Minimum fruit juice %	Minimum TSS %	Acidity max. %	Max. preservative (free SO <sub>2</sub> ) ppm
Squash	25	40	3.5	350
Syrup	25	65	3.5	350
Ready to serve beverages	10	10	—	70

filter the juice through muslin cloth. To the clear juice, add the other items and stir well. Bottle the juice and store in cool place.

### 3. Cashew apple syrup

#### Ingredients

Clarified cashew apple juice	- 1 litre
Citric acid	- 15 g
Sugar	- 2 kg
Lemon yellow colour	- Should not exceed 100 ppm (100 mg l <sup>-1</sup> )

#### Preparation

Add sugar @ 2.0 kg litre<sup>-1</sup> into the clarified cashew apple juice and then heat moderately. Continue heating with continuous stirring till the sugar completely dissolves. Then add citric acid @ 15 g litre<sup>-1</sup> (dissolved in little quantity of syrup) and stir well. Remove the solution from the stove, cool, strain and then add colour (dissolved in little quantity of syrup). Now syrup is ready. To store the syrup for long periods without spoilage, pour into well sterilized glass bottles/new food grade pet bottles and seal air tight. It can be stored for one year. Keep in a cool, dry place. Dilute the syrup five times with cool water to use as fresh drink.

### 4. Blended cashew apple - Pineapple squash

#### Ingredients

Clarified cashew apple juice	- 125 ml
Pineapple juice	- 125 ml
Water	- 350 ml
Sugar	- 400 g
Citric acid	- 5 g

Lemon yellow colour	- Should not exceed 100 ppm (100 mg l <sup>-1</sup> )
---------------------	---

#### Preparation

Take required quantity of sugar and citric acid in water and boil. Towards the end, switch off the flame and add clarified cashew apple juice immediately in hot condition itself by stirring. Cool, add pineapple juice and colour and bottle it after sieving through a clean muslin cloth. Bottle in sterilized glass bottles or new grade pet bottles and seal it air tight. Keep in cool dry place. Dilute the squash three times with cool water to use as fresh drink.

### 5. Ready-to-Serve beverage (RTS beverage)

#### Ingredients

Clarified cashew apple juice	- 150 ml
Sugar	- 120 g
Water	- 730 ml
Citric acid	- 5 g
Lemon yellow colour	- Should not exceed 100 ppm (100 mg l <sup>-1</sup> )

#### Preparation

Take required quantity of sugar and citric acid in water and boil. Towards the end, switch off the flame and add clarified cashew apple juice immediately in hot condition itself by stirring. Cool, add colour, strain and bottle it. Pasteurize the bottles by keeping in boiled water for 20 minutes for a storage life of three months. Packing can also be done in food grade plastic covers using liquid packaging machine. But it cannot be pasteurized and hence can be kept only for 2-3 days, unless kept under refrigerated condition.

## 6. Cashew apple - Pineapple blended RTS beverage

### Ingredients

Clarified cashew apple juice	- 75 ml
Pineapple juice	- 75 ml
Sugar	- 150 g
Water	- 700 ml
Citric acid	- 5 g
Lemon yellow colour	- Should not exceed 100 ppm (100 mg l <sup>-1</sup> )

### Preparation

Take required quantity of sugar and citric acid in water and boil. Towards the end, switch off the flame and add clarified cashew apple juice immediately in hot condition itself by stirring. Cool, add pineapple juice, colour and bottle it after sieving through a clean muslin cloth. Pasteurize the bottles by keeping in boiling water for 20 minutes.

## 7. Cashew apple - Mango mixed fruit jam

### Ingredients

De-tanned cashew apple pulp	- 500 g
Mango pulp	- 500 g
Sugar	- 1.0 kg
Citric acid	- 2.5 g

### Preparation

Fresh ripe mango fruits are washed, peeled, sliced and made into pulp using a mixer or pulper. Add KMS @ 2.5 g and citric acid @ 5 g per kg of pulp for storage. Mix the pulps in the ratio of 1:1. Add one kg sugar per kg of mixed pulp and citric acid (quantity adjusted as per acidity) and cook it with continuous stirring. When it reaches the appropriate stage for jam, transfer hot into sterilized glass bottles.

## 8. Cashew apple pickle

### Ingredients

De-tanned and sliced raw green fruit	- 1.0 kg
Gingelly oil	- 100 ml

Chilly powder	- 100 g
Fenugreek powder	- 10 g
Asafoetida powder	- 10 g
Turmeric powder	- 5 g
Mustard powder	- 5 g
Mustard	- 2 g
Garlic paste	- 10 g
Ginger paste	- 10 g
Green chilly paste	- 10 g
Vinegar	- 150 ml
Sodium benzoate	- a pinch (0.75 g)
Salt to taste	

### Preparation

Boil gingelly oil in steel vessels. Put mustard seed, asafoetida powder, turmeric powder, fenugreek powder, chilly powder and mustard powder to the boiling gingelly oil. When the colour of chilly powder changes, add all the pastes to it. Then add de-tanned and sliced raw green cashew apple. Heat at least for three minutes, after which vinegar and salt (if needed) are added by thorough stirring. Cover the vessel well and allow to cool. Add sodium benzoate dissolved in little quantity of boiled water and stir. Transfer to clean dry glass jars. Use the product after keeping for one week.

## 9. Cashew apple candy

### Ingredients

De-tanned ripe cashew apple	- 1.0 kg
Sugar	- 1.0 kg
Citric acid	- 1.0 g
Potassium metabisulphite	- 1.35 g

### Preparation of cashew apple

Keep the de-tanned apples in a solution of potassium metabisulphite (half the quantity i.e. 625 mg) for 2-3 days. Thoroughly wash the apples in water. Remove black spots and parts of pedicel. Keep in perforated crates of stainless steel and steam for 10-20 minutes in pressure cooker without over cooking. Make deep holes in the apple using bamboo sticks or steel forks to facilitate entry of sugar syrup in the next stage.

### Preparation of sugar syrup

Dissolve 250 g sugar in one litre of water and heat well. Dissolve citric acid (1.0 g) and potassium metabisulphite (625 mg) in this solution.

### Preparation of candy

Drop the pre-prepared apple pieces into the boiling sugar syrup so that the apples are completely immersed. Cover the container with lid and keep as such for one day. Take out the fruits on the 2<sup>nd</sup> day, add 125 g sugar, and drop the apple while heating. Repeat it for 5 days. On 8<sup>th</sup> day, volume of sugar syrup will be reduced to one-third. Keep the apples as such for 8-10 days. Remove the apples from the syrup solution, drain for 30 minutes and dry it slowly in open area by spreading in a polythene sheet. Keep it in clean, dry, screw capped glass jars in a cool, dry place. It can be stored for one year in air tight containers under refrigerated condition.

### 10. Cashew apple vinegar

#### Ingredients

Unclarified cashew apple juice	-	1.0 litre
Sugar	-	158 g
Powdered sago	-	5 g
Mother vinegar	-	As needed
Starter solution	-	2 g yeast + 20 ml coconut water

#### Preparation

Cashew apple vinegar preparation consists of two stages i.e., alcoholic fermentation and acidic fermentation. Add 2.0 g yeast in 20ml coconut water and keep for 12 hours to make starter solution. Add sugar, cooked and cooled sago along with starter solution into one litre of extracted unclarified juice and keep it for twelve days for alcoholic fermentation in

narrow mouthed plastic bottles, with cotton plugging. After twelve days filter the fermented supernatant juice (to obtain alcoholic ferment) into a wide mouth glass container or clay pot and add thrice the quantity of mother vinegar for acetic fermentation. Keep it tied with a muslin cloth, allowing air passage, for 15 days. Filter the clear juice portion to a clean stainless steel, pasteurize by keeping in boiling water for 10 minutes, cool and bottle it on the 16<sup>th</sup> day to get vinegar with 5-6 per cent acidity. For continuous vinegar production, the filtrate can be used as mother vinegar.

### 11. Cashew apple wine

#### Ingredients

Cashew apple pieces	-	1kg
Sugar	-	1kg
Lukewarm water	-	1 litre
Clove	-	5 g
Cardamom	-	5 g
Starter solution	-	10 g sugar + 100 g luke warm water + 5 g yeast

#### Preparation

Prepare starter solution by mixing 5 g yeast and 10 g sugar in 100 ml lukewarm water and keep for 30 minutes. Place one kg of cashew apple pieces and one kg of sugar in one litre of lukewarm water along with 5 g each of clove, cardamom and cinnamon in a porcelain vessel, mix together and keep air tight for 21 days. Shake daily the ingredients without opening the vessel. Strain the solution through muslin cloth after 21 days, again keep for 21 days and strain to get the cashew apple wine.

#### Other products

Methods have been standardized for the preparation of canned cashew apple, cashew apple chutney and cashew apple liquor at Kerala Agricultural University.

## COTTON (*Gossypium* sp.)

Cotton is grown from sea level to moderate elevations not exceeding 1000 m where the climate is tropical with rainfall 500 to 750 mm. Excessive rain at any stage is harmful to the crop. It can be grown in a wide variety of soils. A deep homogeneous fertile soil is desirable.

### Seasons

Winter crop : August - September

Summer crop : February - March

Cotton varieties with spacing and duration are given in Table 17 and seed rate for cotton is given in Table 18.

### Preparation of land and sowing

Plough the land three to four times and form ridges and furrows. Dibble the seeds on the sides of the furrows. Use basal N @ 2.5 t ha<sup>-1</sup> before irrigating the field to control weeds.

Note: Treat the seeds with carbendazim 50 WP (2 g kg<sup>-1</sup>) or Trichoderma viride talc preparation (4 g kg<sup>-1</sup>) before sowing.

### Manuring

Apply FYM or compost @ 12.5 t ha<sup>-1</sup> for rainfed crop and 25 t ha<sup>-1</sup> for irrigated crop. Apply N:P<sub>2</sub>O<sub>5</sub>:K<sub>2</sub>O each @ 35 kg ha<sup>-1</sup> as basal dressing. Top dress with 35 kg N per ha<sup>-1</sup> about 45 days after sowing.

### After cultivation

Thin the crop when the plants are 15 to 20 cm high, retaining two seedlings per hill. Retain only one seedling per hill in the case of hybrids. Timely weeding and hoeing will ensure good crop growth.

### Irrigation

In the case of irrigated crop, irrigate the plants once in two weeks. Copious irrigation during flowering will ensure good pod setting and good fibre quality.

### Plant Protection

Against sucking pests like jassids, aphids and thrips, spray imidacloprid (100 ml ha<sup>-1</sup>) on 20<sup>th</sup> day and 40<sup>th</sup> day.

Table 17. Cotton varieties, spacing, duration and season

Variety	Spacing (cm)	Duration (days)	Season
MCU 5 / MCU 5 VT	75 x 45	175	Irrigated crop (Aug - Sept.)
TCHB 213 (hybrid)	120 x 60	190	Irrigated crop (Aug - Sept.)
Savita (hybrid)	90 x 60	165	Irrigated crop (Aug - Sept.)
LRA 5166	60 x 30	150	Rainfed crop (Aug - Sept.)

Table 18. Seed rate for cotton

	Variety	Delinted seeds	Fuzzy seeds
Irrigated	MCU 5/MCU 5 VT	5.0 kg	8.0 kg
	TCHB 213	2.5 kg	-
	Savita	3-4 kg	-
Rainfed	LRA 5166	8-10 kg	10-12 kg



To control whitefly, use neem oil (3.0 l/ha<sup>1</sup>) or phosalone (1000ml ha<sup>1</sup>).

For bollworm, spray quinalphos or chlorpyrifos.

For bacterial blight disease, use streptomycin (50 g ha<sup>1</sup> + copper oxychloride

1.5 kg ha<sup>1</sup>). For grey mildew, carbendazim @ 250 g ha<sup>1</sup> may be used. For *Alternaria* leaf spot, use copper oxychloride @ 1.5 kg ha<sup>1</sup>.

Harvesting

The bolls start bursting 100-120 days after sowing and will be ready for harvest at this stage.

## RUBBER (*Hevea brasiliensis*)

Rubber can be cultivated from sea level up to an altitude of 500 m. The major rubber tract experiences a monsoon climate with annual rainfall ranging from 2000–4500 mm. Soils of the traditional belt are highly weathered and are mostly laterite and lateritic types. Red and alluvial soils are also found in some areas. Rubber grows in a wide range of soils however; deep well drained soils free from underlying sheet rocks are well suited for the cultivation of rubber.

Propagation

1. Clonal seeds : Collected from approved seed gardens in the country and abroad
2. Budded plants: Either poly bag or root trainer plants can be used for planting

Approved cultivars

The planting material recommendation of the Rubber Board is based on a multi clone concept. Monoclonal plantations in general are prone to the outbreak of epidemics and RRII 105 is prone to *Corynespora* leaf disease as manifested in the Karnataka region during the year 2000. Realizing the potential risk involved in monoclonal planting, the Board from 1991, has been recommending planting of as many clones as practicable, out of a select list of desirable clones.

The clones under each category for the different regions are listed below:

a. Traditional region

Category I : Clone: RRII 105, RRII 430, RRII 414, RRII 417, RRII 422 and PB 260

Category II : Clone RRIM 600, GT I, RRII 5, RRII 203, PB 28/59, PB 217, PB 255, PB 280, PB 312 and PB 314

Category III Clones RRII 118, RRII 208, RRII 300, RRII 429, PR 107, PR 255, PR 261, PB 86, PB 5/51, PB 235, PB 311, PB 330, RRIM 605, RRIM 701, RRIM 703, RRIM 712, RRIC 100, RRIC 102, RRIC 130, KRS 163, IRCA III, IRCA 109, IRCA 130, SCATC 88-13, BPM 24 and Polyclonal seeds.

In addition, other promising clones approved by the Rubber Board are also included.

b. Clones recommended for the North Eastern Region

Category I : RRIM 600

Category II : RRII 105, GT 1, PB 235, RRII 208, RRII 203, RRII 429, RRII 430 and RRII 417.

Category III : RRII 5, RRII 422, RRII 118, PB 260, PB 310, PB 311, RRIM 703, SCATC 88-13, SCATC 93-114, Haiken 1 and polyclonal seedlings.

c. Clones suitable for Karnataka and South Konkan

GT - 1, RII 203\*, PB 260, PB 217\*, RRII 414, RRII 430, RRII 422, RRII 429, PB

280, PB 312, PB 314, PB 235, RRII 5, RRII 300, PB 311\* and RRII 105\* have exhibited good growth and yield in the region.

\* RRII 105 is highly susceptible to *Corynespora* leaf disease. Hence recommended prophylactic and control measures are to be adopted. PB 217 and RRII 203 are also susceptible to the disease and require prophylactic protection. PB 311 is wind susceptible hence planting of this clone in wind prone areas is to be avoided.

d. Planting materials suitable for North Konkan

RRIM 600, RRII 208, RRII 105, RRII 6, RRII 5, PB 260, PR 255 and RRIC 100 perform well in this region. The RRII 400 series clones have not been evaluated in North Konkan. However, the drought tolerant and stable clone RRII 430 shows good initial establishment and growth and could be planted in the region. Lifesaving irrigation is to be given to all clonal plantings in the first three years. For cultivation under rainfed/unirrigated conditions, polyclonal seedlings are the best choice.

Category 1 consists of clones officially released by the Rubber Board of India for planting in large areas. However, it is recommended that any one of these clones may be used to plant only up to 50 per cent of the total area of a large holding.

Category II consists of clones with consistent performance in this country over a long term in large scale trials. It is recommended that combinations of three or more of these clones may be used to plant up to 50% of the total area of a large holding. Cattle manure and 4 kg of rock phosphate for every 100 m<sup>2</sup> of nursery bed is recommended as basal dressing.

When the same area is repeatedly used, rock phosphate needs to be applied only once in three years. Application of 275 kg urea, 700 kg rock phosphate (18% P<sub>2</sub>O<sub>5</sub>), 85 kg muriate of potash and 235 kg magnesium sulphate or 1250 kg 10-10-4-1.5 NPKMg mixture and 118 kg magnesium sulphate per hectare 6 – 8 weeks after planting is recommended. Zinc sulphate @ 25kg/ha may be applied 2 weeks after the fertilizer application. After 6 – 8 weeks from first fertilizer application, urea may be applied @ 275 kg/ha. Subsequently, application of Zinc Sulphate in the nursery may be carried out on soil test basis.

Plant protection by regular spraying of fungicides and insecticides will be necessary to prevent disease/insect pest damage. When sufficiently grown, seedlings can be used for budding.

Bud wood nursery

Bud wood nursery is raised by planting polybag plants or budded stumps of authentic planting materials of desired clones at a spacing of 90 x 60 cm. Before planting, bud wood nurseries are given a basal dose 165 kg of powdered rock phosphate per hectare (1.65 kg/100 m<sup>2</sup>). Two to three months after planting, 125 g of 10-10-4-1.5 NPKMg mixture per plant is applied. A second application at the same rate is given 8 to 9 months after planting. This dose should also be applied 2-3 months after each harvest of bud wood. The first harvest of brown bud wood is done one year after planting by cutting the shoot 30 cm above the bud union. Two sprouts are allowed to grow for the second harvest after similar growth. This process of cutting back each healthy shoot is to be repeated every year to allow regeneration of fresh bud wood.

Green bud shoots are generated by cutting back the growing shoots in a bud wood nursery 6 to 8 weeks before bud grafting.

### Polybag and root trainer nurseries

Polybag and root trainer grown plants grow well when maintained in poly houses. This is particularly useful for green/young budded plants. Reduction in disease incidence and increased growth is observed in poly houses. Prevention of excess sunlight using shade nets and appropriate ventilation to avoid heat and humidity build up are necessary for healthy growth of plants. Regular but controlled watering and manuring are essential.

Category III consists of superior clones with proven merit in small scale trials and found promising in the early years in large scale trials in India or abroad (in the case of introduced clones). These clones are recommended for only experimental planting on a limited scale not to exceed 15 per cent of the total area in aggregate. Polyclonal seeds are also included in this category and recommended for planting in marginal areas.

Most of the modern high yielding clones are prone to tapping panel dryness when tapped under half spiral alternate daily system. It is, therefore, strongly recommended that all such clones be tapped at a lower intensity, say, on half spiral once in three days. Prophylactic protection against diseases is recommended for the cultivation of all these clones.

### Rubber Nursery

Nurseries are maintained for raising seedlings, budded plants and bud wood. As rubber seed viability is very short, seeds are collected for planting soon after fruit dehiscence. Germination beds are prepared with the top 5 cm made up of river sand or well leached coir pith. The beds should be raised 10-15 cm above ground to avoid water logging and be of 90 cm width and convenient length. Partial shading may be provided to protect from strong sunlight. Seeds are sown closely in single layer

and pressed firmly into the sand leaving the surface of seeds just visible above the sand. Seeds sprouted on each day should be picked into a vessel containing water to avoid injury. The picked seeds should be planted in seedling nursery without any delay.

### Seedling nursery

Level lands with water table at least 60 cm below is ideal for raising seedling nursery. Shaded areas should be avoided. Soil should be deep, well drained loam with good fertility status. Raised beds (15 cm) should be prepared with width of 60 to 120 cm and convenient length with pathways in between to facilitate cultural operations.

The spacing adopted for planting in seedling nurseries are 23 x 23 cm (for green budding) and 30 x 30 cm (for brown budding). Application of a pre-emergent herbicide Diuron at the rate of 2.5 kg in 700 litres of water per effective hectare if applied after preparation of beds prevent weed growth for 6 to 7 weeks. Manual weeding should be done at monthly intervals. Mulching in between the plant rows reduces weed growth besides conserving soil moisture and regulating soil temperature. Addition of 25 kg of compost or dried FYM is also recommended.

### Planting materials

The generally used planting materials are seedling stumps, budded stumps, polybag plants and root trainer plants.

**Stumps:** Seedling stumps are prepared by pulling out polyclonal seedlings and cutting back the stem at 45 to 60 cm of brown wood, tap root to convenient length and trimming of lateral roots (7.5 cm length). The cut end of stem is dipped in molten wax to prevent water loss. Budded stumps are prepared in the same way as seedling stumps but a slanting cut with slope towards opposite side of bud is given at about 7.5 cm above the bud patch.

**Polybag plants:** Polybag plants are raised either by budding seedlings that are developed by in situ planting of seeds (in polybags) or by planting budded stumps in polybags. Polythene (LDPE/HDPE) bags of 45 x 18 cm holding about 7 kg soil are generally used. Larger bags 55 x 25 cm which holds about 10 kg soil are preferred for raising larger plants (3 whorls or more). The polythene material used for the bag should be 75-100 micron thickness (300-400 gauge). The bags should be filled with top soil. About 20 to 25 g rock phosphate is incorporated in the top half of the soil filled in the polybags. Monthly application of the fertilizer 10:10:4:1.5 NPK Mg mixtures at 10g/plant initially, gradually increasing up to 30 g/plant, when each top whorl of leaf is mature is recommended. Regular watering and weeding is necessary. Partial shading (50% shade) during dry season reduces incidence of leaf spot diseases and sun scorch besides regulating transpiration loss. Plants are transplanted to the main field when they are at two to three whorl stages and the top whorl of leaves is mature.

**Root trainer plants:** The root trainer cups usually have a length of 26 cm and a holding capacity of 600 cc with vertical ridges on the inside wall and tapering with a drainage hole at the bottom. Well cured coir pith (washing with water at least for two months to leach out all toxic compounds) mixed with neem cake, bone meal, pesticides and single super phosphate is used as potting medium. Partially dried elephant dung mixed with equal quantity of soil can also be used as an alternative to coir pith. The potting medium should be packed well inside the root trainer cup before planting seeds. Root trainers are stacked in a raised bed of soil so as to facilitate tap root development. When the plants show healthy growth, the root trainer is lifted from the bed,

tap root pruned near the drainage hole and stacked on stand made of iron/bamboo splinters. The tap root undergoes natural air pruning, which induces stress and thereby several lateral roots emerge inside the container. The ridges on the side walls direct these laterals to the drainage hole which also undergoes air pruning. Thus a hardened root trainer plant consists of a dense root plug with tap root and well oriented lateral roots.

### Planting

Planting should be done with the onset of monsoon when the weather conditions are ideal with sufficient rains.

**Spacing:** The density of planting recommended is 420-520 plants per hectare (170 to 200/acre). However for the clone RRII 105 the density can be upto 550/ha. Some common spacing adopted and the corresponding number of plants is given in Table 19.

**Lining:** In flat or slightly undulating areas, square or rectangular planting can be adopted. For rectangular planting, lines should be taken east-west to get maximum sunlight. Contour lining is done on undulating and hilly lands by marking out the planting points in contour lines across the slope.

**Soil and water conservation:** Formation of terraces is a recommended practice in hilly areas to conserve soil and water. In order to reduce erosion further and to facilitate rain water infiltration trenches of about 120 cm length, 45 cm width and 60 cm depth are taken along with contour in between the planting rows. Construction of stone-pitched contour retaining walls (edakayyalas) is another effective method to restrict surface runoff.

**Drainage:** Proper drainage is essential especially on low-lying lands. The natural

waterways existing in the plantation may be cleared or deepened to give adequate drainage. If drains are cut, uniform depth should be maintained throughout.

#### Pitting

Pits are taken either manually or mechanically using tractor-mounted hole-diggers or earth mover. The texture and depth determine the size of the pit. In soils with a depth of one meter or more, planting can be done in small pits dug to accommodate polybag plants. However in hard soils, planting should be done in larger pits of size 75 cm<sup>3</sup> or 90 cm<sup>3</sup> depending on hardness.

While digging the pit, the top soil should be placed on one side and subsoil on the other. Filling should be done with top soil after removing stones and roots. Compost or well-

rotted cattle manure @ 12 kg and rock phosphate 200 g are mixed with the top 20 cm soil in the pit. When small pits are taken, the manure should be incorporated around the plant basin leaving around 15 cm from bud union. In newly-cleared forest areas, 200 g rock phosphate alone would suffice.

#### Field planting

Seed-at-stake: Two to three germinated seeds are directly planted in the centre of the refilled pit. After establishment, the most vigorous one is retained which is field-budded subsequently.

Seedling and budded stumps: Planting of seedling and budded stumps should be done immediately after pulling out. While planting budded stumps, the bud patch should be just above the ground level to reduce the effect of elephant foot and infection by soil-borne

Table 19. Plant density at different spacings

Spacing		No. of plants/ha.	No. of plants/acre
Meters	Feet		
Rectangular system			
5.5 x 3.7	18 x 12	499	202
5.8 x 3.0	19 x 10	566	229
5.8 x 3.4	19 x 11	514	208
6.1 x 3.0	20 x 10	539	218
6.1 x 3.4	20 x 11	489	198
6.4 x 3.0	21 x 10	511	207
6.4 x 3.4	21 x 11	467	189
6.7 x 3.0	22 x 10	489	198
6.7 x 3.4	22 x 11	445	180
7.0 x 3.0	23 x 10	467	189
Square system			
4.3 x 4.3	14 x 14	549	222
4.6 x 4.6	15 x 15	479	194
4.9 x 4.9	16 x 16	420	170

pathogens. A hole with depth equal to the length of tap root is made at the centre of the pit. After leveling the soil, the stump is placed in the hole with its tap root and lateral roots spread out in proper position so that the tip of the root is in contact with bottom soil and no air gap is left in between. The hole is then filled and the soil around the stump is packed firmly with the help of a crowbar.

**Polybag plants:** At the time of planting, the top whorl of leaves of the plant should be fully mature. A planting hole slightly bigger than the size of the polybag is made. The tip of the tap root if grown out of the bag should be removed. The bottom of the bag is cut and the bag along with the plant is placed in the hole, gradually filling the hole with the soil core intact. The cut is continued as the bag is slit open and carefully removed. The soil is finally packed firmly around the plants.

**Root trainer plants:** At the time of planting, the root plug can be separated from the container without any damage by inverting it and giving a gentle tap of the rim of the root trainer on any hard surface. A planting hole can be made in the refilled planting pit by pressing the empty root trainer container into soil. The root plug is carefully inserted into the planting hole and the soil around is compacted. The root trainer plants show early establishment due to its well-developed root system.

**Mulching, shading, irrigation and whitewashing:** The soil around the plants should be mulched properly before the onset of summer to conserve soil moisture, maintain optimum soil temperature and control weed growth. Young plants during the year of planting are provided with artificial shade during summer with plated coconut leaves or gunny bags. From the second year onwards, brown portion of the main stem is whitewashed

using lime or china clay to prevent sun scorching till the canopy develop partial shade.

**Cover crops:** Cover crops are established and maintained in rubber plantation for conserving soil and improving or maintaining soil structure and fertility. Fast growing leguminous creepers, having the ability to fix atmospheric nitrogen in addition to other attributes common to all cover plants like suppressing weed growth, reducing soil temperature etc., are widely used as cover crops in rubber. The common cover crops established in rubber plantations are *Pueraria phaseoloides* and *Mucuna bracteata*. Seeds of cover crops have very hard seed coat which delays or inhibits germination. Therefore, pre-sowing treatment is done to ensure uniformity and higher percentage of germination.

**Weed control:** The concept of weed management in rubber plantation is to manage the weeds in such a way that they do not adversely affect the growth of rubber. Complete eradication of the entire weed flora from the field is not envisaged. Weeds can be controlled by manual, chemical (using herbicides) or mechanical (using weed cutters) methods. Manual weeding and herbicide application can also be done in rotation for effective weed control and better environmental safety.

Different herbicides are used depending upon the type of weed for effective control. Herbicide spraying is most effective when done during sunny weather and in the absence of wind. The post-emergent herbicides effective in controlling weeds in rubber and their dosage are furnished in Table 20.

Weed cutters offer ample scope for the management of weeds in rubber plantations and there is 40 - 50 per cent savings in weeding cost over manual weeding.

Table 20. Herbicides and their dosage

Name of chemical	Dose/ha	Frequency of application	Target weeds	Quantity/ L water	Volume of water (L)/ effective ha
Paraquat # +2, 4-D (Tank mix)	2.25 L* 1.25 Kg**	4 rounds at An interval of 6-8 weeks	Grass weeds and broad leaved weeds	4.5 ml* 2.5 g**	500-600
Glyphosate	2 L***	2-3 rounds at 3 months interval and spot application of 0.5 to 2.5 L Paraquat/ha	Grass weeds and broad leaved weeds	5.0 ml***	400

For formulations of \* 20% EC, \*\* 80% WP and \*\*\* 41% SL

#Banned in Kerala

### Intercropping

Rubber is planted at a wide spacing and hence sufficient land and light are available in the inter-row areas during the initial years for intercropping. Intercrops should be selected based on slope of the land, light availability in the plantation and marketability.

#### Guidelines for intercropping

1. Intercrops should be selected based on the slope of the land. If the slope is less than 5 per cent, any intercrop can be cultivated. If the slope is more than 5 per cent, intercrops which require less soil disturbance should be selected. If the slope is more than 25 per cent, intercropping is not advised. In such plantations, cover crops should be established. Tillage operations should be restricted to minimum while intercropping.
2. During the first two years, light is not limiting for intercropping and hence any annual or short-term crop can be cultivated. From third year onwards, light availability in the interspaces decreases and hence partially shade tolerant crops like tuber crops may be cultivated.
3. Intercrops should be planted at least 1.5 m away from the base of rubber plant and this distance should be maintained during later year also.
4. Manures and fertilizers should be applied separately to rubber and intercrops as per requirement of the crop. For manuring intercrops, the recommendations given by the Kerala Agricultural University should be followed. For perennial intercrops, the dose of chemical fertilizers can be reduced to 50 per cent after 5 years.

5. The residues of intercrops should be retained in the field.
6. Cover crops should be established along with intercrops.
7. The fertilizer application to intercrops will affect soil nutrient status. Hence after intercropping, fertilizer application for rubber should be done based on soil testing to avoid nutrient imbalances.

#### Annual and short term intercrops

Banana, pineapple, tuber crops, ginger, turmeric and diverse vegetable can be cultivated in young rubber plantations following the guidelines. Short duration vegetables like amaranthus can be cultivated in mature rubber plantation also during the wintering period.

#### Perennial crops

Shade tolerant perennial crops with canopy underneath rubber viz., coffee, cocoa and vanilla on *Glyricidia* standards can be cultivated as intercrops without adversely affecting growth and yield of rubber and soil fertility from the young phase onwards. Coffee and cocoa can be established during the mature phase also. When perennial crops are cultivated with rubber, yield will decrease after canopy closure of rubber. Medicinal plants like aratha (*Alpinia calcarata*), Karimkurinji (*Strobilanthes haenianus*) and Chuvanna koduveli (*Plumbago rosea*) also can be cultivated as intercrops in mature rubber plantations.

#### Manuring

The general fertilizer recommendations for rubber plantation of the traditional are provided in Table 21. However, these are subject to modifications for individual holdings based on soil and leaf nutrient status, soil type, age of the plantation, management practices followed, etc. Application of compost/farm yard manure

enhances growth of rubber and adds to fertility of soil.

As zinc deficiency is commonly noticed especially in young rubber, zinc sulphate application @ 25 kg/ha or 50g/plant mixed with equal quantity of farm yard manure or top soil (for uniform distribution) two weeks after the post monsoon fertilizer application during the year of planting is advocated as an ad hoc recommendation.

#### Time and frequency of fertilizer application

Fertilizer should be applied when there is sufficient moisture in the soil. However, heavy rainfall period should be avoided to minimize runoff and leaching losses. In the year of planting, fertilizer application is done 2-3 months after planting i.e., during September-October. From second year onwards, the fertilizers should be applied in two equal splits during April-May (pre-monsoon) and September-October (post-monsoon) when there is enough moisture in the soil. For manure rubber also, fertilizers can be applied in two equal splits, first application after a period of about 30 days after the onset of pre-monsoon showers after ensuring the presence of prolific feeder roots in the surface soil and second application during September-October.

#### Method of application

During the first year, fertilizers should be evenly distributed over a circular band of 30 cm all around the base of young plant, leaving about 7 cm from the base and slightly forked into the top 5 to 8 cm of soil. The plant bases should then be immediately mulched. The second application (9 months after planting) should be done in a circular band of 45 cm width leaving 15 cm around the plant base. The applications in subsequent years till the canopy of the rubber plant closes should be made in circular bands of steadily increasing width.



Table 21. Recommended doses of straight fertilizers for the traditional region

Age of rubber	Dose of NPK Mg/ NPK (kg/ha/year) *	Straight fertilizers (g/plant)							
		Urea (46% N)		Rock phosphate (18% P <sub>2</sub> O <sub>5</sub> )		Muriate of potash (60% K <sub>2</sub> O)		Magnesium sulphate (16%MgO)****	
		April-May	Sept-Oct	April-May	Sept-Oct	April-May	Sept-Oct	April-May	Sept-Oct
First year #	20:20:8:3	-	100	-	250	-	30	-	40
Second year	40:40:16:6	100	100	250	250	30	30	40	40
Third year	50:50:20:7.5	120	120	300	300	40	40	50	50
Fourth year**	40:40:16:6	100	100	250	250	30	30	40	40
From fifth year till tapping									
a) With cover crops	30:30:30	80	80	200	200	65	65	—	—
b) With natural cover	60:40:24	165	165	275	275	50	50	—	—
Rubber under tapping ##	30:30:30	80	80	200	200	65	65	—	—

\* Considering a stand of 445 during the initial four years.

\*\* For plantation without cover crop, the third year recommendation may be continued during fourth year also.

\*\*\* Magnesium is recommended for plantations in Thiruvananthapuram, Kollam, Alappuzha, Pathanamthitta, Kottayam, Idukki and Emakulam districts in the traditional belt. It is not recommended for the rest of the area as the available Mg status is high.

# When budded stumps are planted, only half the recommended quantity should be applied during first year.

## For plantations with magnesium deficiency symptom (interveinal yellowing of leaves during September-December period), 50 kg of magnesium sulphate/ha is recommended.

Once the canopy closes, fertilizers should be applied in square or rectangular patches in between four trees and gently forked in. Where legume cover is present or where it has died out leaving thick mulch, broadcasting in the inter-row areas can be resorted to.

#### Discriminatory fertilizer recommendation

Fertilizer recommendation based on soil and leaf analysis ensures site-specific fertilizer application for rubber and is the most ideal approach. This facility is available at the Rubber Research Institute of India and also at the Regional Laboratories at Adoor, Kanjirappally, Pala, Muvattupuzha, Thrissur, Kozhikode and Nedumangadu.

#### Harvesting

##### Tapping

Latex is obtained from the bark of the rubber tree by tapping, a process of controlled wounding during which thin shavings of bark are removed. Both "Michie Gollidge" knife used in India as well as the draw knife or 'Jebong' knife common in Malaysia are suitable for high and low level tapping and higher tasks.

##### Marking, slope, direction of tapping cut and latex regeneration

The tapping cut of budded trees should have a slope of about 30° to the horizontal and for seedling trees only about 25°, since the fairly thick bark prevents spillage. The latex vessels in the bark run at an angle of 3-5° to the right and therefore a cut from high left to low right will open more latex vessels.

##### Tapping depth, bark renewal and bark consumption

Latex vessels are concentrated near the cambium. Hence, high yield is obtained by

tapping to a depth of less than one millimeter close to the cambium. Bark regeneration is brought about by the activity of the cambium. Bark shaving thickness should vary depending on the frequency adopted.

##### Time of tapping and task

Tapping should commence early in the morning as late tapping reduces the exudation of latex. Headlight can be used for visibility during early morning tapping. Completion of tapping and latex flow in the early hours (02.00 to 6.00 hrs.) is good for higher yield. It is particularly important during summer and in wind-prone areas. The tapping task (number of trees tapped on a day by one tapper) in India is 300-400 trees.

##### Tapping system

Response to different tapping systems varies from clone to clone. For high yielding clones (RRII 105, RRII 400 series clones, PB 260, PB 235 etc.), the trees are to be tapped on half spiral third daily (S/2 d3) system. Alternate daily tapping can be practiced only for medium yielding clones (RRIM 600, GT 1, PB 28/59 etc.).

##### Low frequency tapping (LFT)

Low Frequency Tapping (LFT) with yield stimulation using ethephon (2-chloroethyl phosphonic acid) can be practiced from the first year of tapping to reduce the cost of tapping and increase productive life of trees and timber volume. The LFT systems recommended are of d3, d4 or d7 frequency.

##### Controlled Upward Tapping

Controlled Upward Tapping (CUT) is a proven harvesting practice to achieve sustainable high yield for long term from old and senile trees. The combination of Low Frequency Tapping with CUT from renewed

panel stage can increase the economic life of trees up to 40 to 50 years. In general 30-50 per cent higher yield can be obtained for many years under CUT.

The normal recommended CUT practice in India is periodic panel changing ie, basal panel tapping (S/2) with rain guard during rainy season, and CUT (S/4) on high panel during non-rainy season. The length of tapping cut can be quarter spiral for CUT irrespective of the girth of tree and its slope should be 45°. For CUT, a modified long handled gouge knife must be used so that the tapper can stand on the ground and tap the high panel.

Tapping cut in the high panel can be stimulated using 5 per cent ethephon following lace application method. For third daily (d3) tapping of quarter spiral cut in the high panel, monthly stimulation is enough for high yielding clones (like RRII 105) and stimulation at once in three weeks intervals is necessary for medium yielding clones.

#### Rain guarding

A suitable device is fixed on the trunk just above the tapping cut and flow of water through the main trunk is channeled out. This method is found to be effective to keep the tapping cut and the bark below and above in dry condition during the rainy season. Chances of bark rot are high when the trees are rain guarded and tapping is continued during rainy season. Irrespective of the type of rain guard used, regular panel washing using fungicide (mancozeb 0.37%) at 10-15 days interval is necessary to prevent incidence of panel diseases. With the introduction of Low Frequency Tapping, rain guarding is needed even under low rainfall conditions. Types of rain guards recommended are polythene skirt, tapping shade and Guardian/Kissan rain guard.

#### Plant protection

##### Abnormal leaf fall (*Phytophthora meadii*)

##### Symptoms

During south west monsoon period, the fruits rot. Later, infected leaves fall in large number prematurely either green or after turning coppery red with a drop of latex often coagulated in the centre of a black lesion on the petiole.

##### Management

Prophylactic spraying of the foliage prior to the onset of southwest monsoon with 1 per cent Bordeaux mixture (3000-4000 l ha<sup>-1</sup>) or oil based copper oxychloride (30-40 litres of COC-oil mixture per ha mixed in 1:5 proportion) is recommended.

##### Powdery mildew (*Oidium heveae*)

##### Symptoms

Prominently noticed on newly formed tender flush during the defoliation period of January-March. Tender leaves with ashy coating curl, crinkle, edges roll inwards and fall off leaving the petioles attached to the twigs giving a broom stick appearance. In later stages on older leaves white patches appear. Infected flowers and fruits shed.

##### Management

For young plants, spray wettable sulphur (2 g l<sup>-1</sup>) or carbendazim (1 g l<sup>-1</sup>) at fortnightly intervals. For mature trees, dust with sulphur 3-5 rounds at weekly to fortnightly intervals. Sulphur mixed with an inert material like talc (70:30 mixture) is generally used @ 11-13 kg ha<sup>-1</sup> per round.

##### Corynespora leaf spot disease (*Corynespora cassiicola*)

##### Symptom

The disease is prevalent in nurseries (Nov-May) and mature plantations (Jan-May). Large

spots with brown margin and pale centre are formed, which later fall off forming shot holes. On mature trees, light green leaves during refoliation are more susceptible. Defoliation and dieback of twigs are also noticed.

#### Management

Shading in nursery reduces incidence. Spraying mancozeb ( $2 \text{ g l}^{-1}$ ) or carbendazim ( $1 \text{ g l}^{-1}$ ) or Bordeaux mixture 1 per cent is recommended. In mature rubber, micronized spraying with oil-dispersible copper oxy chloride dispersed in spray oil (1:5 proportion) at light green stage of leaves is effective. In mature trees high volume spraying with mancozeb 0.2 per cent, carbendazim 0.05 per cent or Bordeaux mixture 1 per cent at 2-3 week intervals during refoliation is effective. Micron spraying with oil dispersible mancozeb 70 per cent @  $7 \text{ kg}$  dispersed in  $40 \text{ l ha}^{-1}$  spray oil is also effective.

#### Pink disease (*Corticium salmonicolor*)

##### Symptom

Trees in the age group 3-12 years are highly susceptible. The seat of infection is usually at the fork region. White or pink coloured cob-web mycelial growth form on the surface of the bark with streaks of latex oozing out from the lesion; resulting in rotting, drying up and cracking up of the affected bark. The distal portions of affected branches dry and dried leaves remain on these branches.

##### Management

In high disease prone areas, the highly susceptible clones can be treated as a prophylactic measure with Bordeaux mixture or Bordeaux paste. In the early stages of infection, apply Bordeaux paste up to 30 cm above and below the affected region. Thiram ( $7.5 \text{ g l}^{-1}$ ) in pidivyl, china clay and

water mixed in the proportion 1:2:4 by volume is very effective for control. Thiram (0.75 per cent) mixed in petroleum wound-dressing compounds like rubberkote, sokkote etc. is also effective.

Regular inspection of trees during July to September for detecting the infection is recommended. In severe cases, prune off and burn the dried up branches.

#### Bark rot (*Phytophthora* spp.)

##### Symptoms

During rainy season, when trees are tapped, depressions are formed in the tapping panel due to localized rotting and drying of bark. Black vertical lines running downward into the tapping bark and upwards into the renewed bark are noticed. The bark when renewed becomes highly uneven.

##### Management

The tapping cut and nearby bark should be washed with mancozeb ( $3.75 \text{ g l}^{-1}$ ) or phosphoric acid (0.08 per cent) at weekly intervals. The rotten bark may be scraped off and applied with fungicide and then covered with petroleum wound-dressing compound.

Other diseases are patch canker, dry rot, *Colletotrichum* leaf spot disease, bird's eyespot, shoot rot, brown rot etc.

#### Pests

The pests associated with rubber are scale insect, mealy bug, termite, cockchafer grub, mite, snail, rat etc. Appropriate control measures may be adopted after identifying the pest.

(Source: Rubber Research Institute of India, Kottayam).

## SUGARCANE (*Saccharum officinarum*)

Sugarcane grows best in the tropical regions, receiving a rainfall of 750-1200 mm. Sugarcane grows well on medium heavy soils, but can also be raised on lighter soils and heavy clays, provided there is adequate irrigation. The soils should be well drained.

### Season

The normal planting season is October-December. Delay in planting reduces cane yield. The planting season for semi-arid tract is from October-December and in deltaic areas the ideal time is the first fortnight of January. Planting should not be delayed beyond February in the plains. In hilly tracts where sugarcane is cultivated under rainfed conditions, planting should be done after abatement of heavy rains.

### Varieties

CoTI 1358 (Abhay): Tolerant to water logging

CoTI 1153 (Aromal): Suitable for flood prone situations and have high sugar content suitable for jaggery production

Co TI 88322 (Madhuri): Resistant to red rot disease

Co 92175: Suitable for drought prone situation

Co 740: For ratooning

Co 6907, Co 7405 and Cul 57/84 (Thirumadhuram): Red rot resistant, high sugar content

Cul 527/85 (Madhurima): Resistant to red rot, tolerant to drought and water logging

Co 88017 (Madhumathi): Resistant to red rot, tolerant to drought and water logging

### Preparation of land

Plough the land thrice length-wise and breadth-wise and level properly. Prepare furrows 25 cm deep and 75 cm apart for short

duration and 90 cm apart for medium duration varieties. In hilly tracts, prepare pits in rows along the contour at spacing of 30 cm in the row and 75 cm between the rows. For mid-late varieties, an inter-row spacing of 75 cm is recommended.

### Selection of setts

Select top ends of mature, healthy disease free canes up to 1/3 of total length and cut into setts of three eye buds. The seed rate is 40000-45000 setts per hectare.

### Seed treatment

For control of fungus disease like red rot, dip cut ends of setts in 0.25 per cent solution of copper based fungicide.

### Planting

Plant setts end to end in the furrow, with the eye buds facing sideways and cover with soil. In the pit system, plant 2-3 setts in each pit.

### Manuring

Apply compost or cattle manure, 10 t ha<sup>-1</sup> or pressmud 5 t ha<sup>-1</sup> or dolomite 500 kg ha<sup>-1</sup> or calcium carbonate 750 kg ha<sup>-1</sup>. In addition, the following fertilizers as N:P<sub>2</sub>O<sub>5</sub>:K<sub>2</sub>O kg ha<sup>-1</sup> are also recommended.

Pandalam and Thiruvalla areas: 165: 82.5: 82.5  
(Madhuri, Thirumadhuram, Madhurima and Madhumathi)

Chittoor area : 225:75:75

Newly cleared forest areas: 115:75:90

Apply organic manures such as compost/ cattle manure/pressmud as basal dose preferably in furrows and mix well with soil before planting.

In sugarcane tracts of Palakkad where sett treatment with *Azospirillum* @ 500g ha<sup>-1</sup>

together with soil application  $5 \text{ kg ha}^{-1}$  is done, sugarcane need be given only  $175 \text{ kg ha}^{-1}$  N.

When *Azospirillum* and *Phosphobacteria* at  $5 \text{ kg}$  each per ha is integrated with FYM  $10 \text{ t ha}^{-1}$ , sugarcane need be given only 75 per cent of the recommended dose of N,  $\text{P}_2\text{O}_5$  and  $\text{K}_2\text{O}$  (165:82.5:82.5) for deltaic areas.

Apply lime or dolomite or calcium carbonate in the field before final preparation of the land.

Apply N and  $\text{K}_2\text{O}$  in two split doses, the first 45 days after planting and the second 90 days after planting along with earthing up. Do not apply N beyond 100 days after planting.

Apply entire dose of phosphorus as basal dressing. When pressmud at  $10 \text{ t ha}^{-1}$  is applied sugarcane grown in Palakkad need be given only 50 per cent of the recommended dose of P as rock phosphate.

In the black soil of Palakkad apply S at  $60 \text{ kg ha}^{-1}$  in the form of gypsum as a soil ameliorant before the final land preparation.

Among the sources of sulphur, gypsum is found to be beneficial in sugarcane.

#### After cultivation

When ratoon crop of sugarcane is trash mulched @  $4 \text{ t ha}^{-1}$  the crop must be given only 100 per cent of the recommended dose of NPK 225:75:75 against the existing recommendation of 125 per cent.

The crop should be weeded twice on 45 and 90 days after planting before application of fertilizers. First weeding is done by digging on the ridges and by hand in the furrows. Care should be taken to see that the furrows are not filled up while digging so that tillering is not affected. At the time of second digging, the crop is partially earthed up to arrest formation of late shoots. With the

commencement of the south west monsoon, final earthing up should be done to prevent lodging. At this time, de-trashing is to be done to prevent the possible germination of axillary buds and to reduce pest infestation. Prevent lodging either by twisting of trash or by propping.

#### Weed control using herbicides

Apply oxyflurofen at  $0.61 \text{ kg ai ha}^{-1}$  as pre emergent and at 60 DAP as post-emergent application.

Apply metribuzen  $1 \text{ kg ai ha}^{-1}$  as pre-emergent application followed by one hoeing at 60 DAP while integrated weed management is undertaken.

#### Intercropping

Under irrigated conditions, intercropping with short duration pulse crop is recommended. In such cases, sow the pulse crop on the ridges one month in advance, so that the first inter-cultivation is not hindered. As a green manure, sun hemp can also be raised on the ridges.

#### Irrigation

Irrigate the crop 8-10 times depending upon the availability of rains. In Chittoor area, more number of irrigations will be necessary. In early growth periods, irrigate the crop at more frequent intervals. However, avoid too much moisture and water stagnation especially during germination and early growth phases.

Alternate furrow with trash mulching could economise the use of irrigation water to the tune of 41 per cent during the formative phase of spring planted sugarcane as compared to all furrow irrigation with trash mulching.

#### Plant protection

##### Pests

The important pests of sugarcane found in the state are early shoot borers, top shoot

borers, mealy bugs, white grubs, termites and rats.

#### Management

Use pest free setts for planting.

Adhere to clean cultivation.

Use traps or poison baiting for controlling rats.

#### Diseases

##### Red rot

The most characteristic symptom of the disease is the drying up of the canes, which when split open will show characteristic red colouration of the internal tissues with horizontal white patches and the typical foul smell. The disease is mainly transmitted through infected setts and flowing water and can be checked only by prophylactic means which are given below:

1. Affected crop should be harvested as early as possible to prevent loss in yield and deterioration in quality and also to arrest further spread of the disease. The crop residues should be completely burnt after harvesting.
2. When infection is noticed in the field, the affected clumps should be uprooted and burnt promptly.
3. Infected crop should never be ratooned.
4. Water should not be let into a healthy crop from diseased areas and as far as possible, the field may be kept free of standing water by providing drainage channels.
5. In severely affected areas sugarcane should not be cultivated at least for one season during which paddy and tapioca can be cultivated.
6. Seed setts should not be collected from diseased crops and from diseased areas.
7. Movement of seed materials from diseased to healthy areas should be strictly quarantined.

8. Cultivate red rot resistant varieties.

9. To control the fungal diseases, in general, dip the cut ends of setts in copper oxychloride 2 g l<sup>-1</sup> solution before planting.

Other transmissible diseases like grassy shoot, ratoon stunting etc. can be controlled by heat treatment and by implementing three tier seed programme.

##### Harvesting

Harvest the crop when it is fully mature. Delayed harvesting will reduce yield and recovery percentage.

##### Ratoon management

Normally not more than two ratoon crops are recommended. Stubble shaving should be done with a sharp spade wherever the canes are not cut close to the ground.

Spread the trash uniformly in sugarcane field after stubble shaving and dismantling the ridges.

##### Gap filling

Fill the gaps at the rate of one- three budded sett for every 50 cm gap or with poly bag settlings for every 50cm gap. Polybag settlings are produced by planting single budded setts in polythene covers containing potting mixture and transplanted at 45-60 DAP.

##### Manuring of ratoon crop

Ratoon crop requires a higher dose of nitrogen than the plant crop. An extra dose of 25 per cent nitrogen is recommended.

Manure the crop by 25<sup>th</sup> and 75<sup>th</sup> days after harvest of the previous crop. Entire quantity of phosphorus, half of nitrogen and potash are applied as the first dose and the remaining as the second dose. The first dose is incorporated into the soil by digging and the second dose is applied around the clump and earthing up is done. Weeding is also done at this time. Irrigation is given as in plant crop.

## OIL SEEDS

### COCONUT (*Cocos nucifera*)

Coconut requires an equatorial climate with high humidity. The ideal mean annual temperature is 27°C with 5-7° diurnal variation. The palm does not withstand prolonged spells of extreme variations. A well-distributed rainfall of 1300-2300 mm per annum is preferred.

Coconut is grown in different soil types such as laterite, coastal sandy, alluvial and also in reclaimed soils of the marshy lowlands. It tolerates salinity and a wide range of pH (from 5.0-8.0).

The cultural practices have to be adopted to suit the varying climatic and soil conditions.

#### Selection of site

Select sites with deep (not less than 1.5 m depth) well drained soil. Avoid shallow soils with underlying hard rock, low-lying areas subject to water stagnation and heavy clayey soils.

#### Cultivars

1. West Coast Tall (WCT)
2. Lakshadweep Ordinary (Chandrakalpa)
3. Philippines Ordinary (Kerachandra)
4. Andaman Ordinary
5. Java
6. Cochin China
7. Kappadam
8. Komadan
9. Kerasagara
10. Kalparaksha
11. Kalpadhenu
12. Kalpaprabhibha
13. Kalpamithra

#### Hybrids

1. Lakshaganga (Lakshadweep Ordinary x Gangabondam)
2. Anandaganga (Andaman Ordinary x Gangabondam)
3. Keraganga (West Coast Tall x Gangabondam)
4. Kerasankara (West Coast Tall x Chowghat Orange Dwarf)
5. Chandrasankara (Chowghat Orange Dwarf x West Coast Tall)
6. Kerasree (West Coast Tall x Malayan Yellow Dwarf)
7. Kerasoubaghya (WCT x SSA)
8. Chowghat Green Dwarf x West Coast Tall
9. Chandralaksha (Lakshadweep Ordinary x Chowghat Orange Dwarf)

Tender nut variety: Chowghat Orange Dwarf

Keramadhura: A superior coconut suitable for tender nut and copra, with more quantity of nut water (287 ml) with excellent quality. Yield -119 nuts/palm; copra yield (196 g/nut).

#### Note:

1. Hybrids Anandaganga, Keraganga and Kerasankara are recommended for general cultivation both under rainfed and irrigated conditions.
2. Other hybrids especially Chandrasankara are recommended for ideal situations and where good management practices are adopted.
3. Since the performance of Chandrasankara is markedly superior to that of WCT in root (wilt) affected areas, cultivation of Chandrasankara and Kalparaksha are preferred in such areas.



4. Chandralaksha, Lakshaganga, Chandrakalpa and Kalpadhenu are recommended for cultivation under drought prone areas.
5. Kalparaksha is recommended for tender coconut. Kalpaprabha is a dual purpose variety (copra and tender coconut).
6. Kalpamithra is recommended for rainfed conditions.

#### Selection of mother palms

Select mother palms having the following characters:

1. Regular bearing habit and yielding not less than 80 nuts / annum.
2. Age 20 years or more (5 years after reaching full bearing capacity). If the mother palms are the progeny of elite planting material and gives consistently higher yields for a period of not less than 6 years, seed nuts can be collected from such palms. There is no need for insisting 20 years as minimum age for mother palms in such conditions.
3. More than 30 fully opened leaves with short strong petioles and wide leaf base firmly attached to the stem.
4. Bearing at least 12 bunches of nuts with strong bunch stalks.
5. Bearing nuts of medium size and oblong shape.
6. Husked nuts should weigh not less than 600 g.
7. Mean copra content of 150 g per nut or more.

Avoid palms which (i) have long, thin and pendulous inflorescence stalks (ii) produce long, narrow, small sized or barren nuts (iii) show shedding of immature nuts in large numbers and (iv) are grown under favourable environmental conditions.

#### Collection and storage of seed nuts

Collect mature nuts (above 11 month old) during the period from December to May. Lowering of bunches by means of ropes may be done when the palms are tall and ground is hard. Discard nuts, which show improper development or other undesirable features. Store seeds in shade for a minimum period of 60 days prior to sowing in nursery. For storing, arrange the seed nuts with the stalk-end up over an 8 cm layer of sand in a shed and cover with sand to prevent drying of nut water. Up to five layers of nuts can be arranged one over the other. The nuts can also be stored in plots, provided the soil is sandy and the ground is sufficiently shaded. In the case of nuts harvested in May, heap them in partial shade, till husk is well dried and then sow them in the nursery.

#### Selection and preparation of site for nursery

Nursery sites should be well drained with light textured soil and with adequate but not too much shade. In open areas, provide shade during summer. Prepare beds of 1.5 m width and of convenient length with 75 cm space between beds. In areas where drainage is poor, prepare raised beds.

Before sowing, examine seed nuts and discard those without nut water and rotten kernels. Sow the nuts in the nursery after commencement of southwest monsoon during May-June.

#### Spacing of nuts

Plant the seed nuts at a spacing of 30 cm (between rows) x 30 cm (between nuts) with four or five rows per bed.

#### Method of planting seed nuts

Plant the seed nuts in the beds in trenches 25-30 cm deep and cover with soil so that top

portion of husk alone is visible. The nuts may be planted either horizontally with the widest of the segments at the top or vertically with stalk-end up. Vertical planting is preferable on account of convenience in transporting and lesser risk of seedling injury.

#### Care and management of nursery

Provide protective fencing to the nursery if it is located in open area. If the soil is sandy, provide mulching immediately after the cessation of monsoon rain. Irrigate the nursery once in two days during summer months. Keep the nursery beds free of weeds by periodic weeding. If termite is noticed, remove soil in the affected area upto a depth of about 15 cm and dust soil and nuts with carbaryl or chlorpyrifos. Repeat if attack persists. Periodically spray the plants with 1 per cent bordeaux mixture or any other copper fungicide to prevent fungal infection.

#### Selection of seedlings

Remove seed nuts, which do not germinate within 6 months after sowing as well as those with dead sprouts. Select only good quality seedlings (9-12 months old) by a rigorous selection based on the following characteristics.

1. Early germination, rapid growth and seedling vigour.
2. Six to eight leaves for 10-12 months old seedlings and at least four leaves for 9 months old seedlings.
3. Collar girth of 10-12 cm.
4. Early splitting of leaves.

Note: The recovery of quality seedlings will be about 60-65 per cent. Since early germination is one of the criteria for the selection of seedlings, the storing and

sowing of seed nuts should be in lots rather than in a staggered manner.

#### Removal of seedlings

Remove seedlings from the nursery by lifting with spade and cutting the roots. Keep the seedlings in shade and do not expose to sun. Plant seedlings as early as possible after removal from nursery. Never allow lifting the seedlings from the soil by pulling the leaves or stem.

#### Preparation of land and planting of seedlings

The nature of preparation of land before planting depends upon topography of land, soil type and other environmental factors. On slopes and in areas of undulating terrain, prepare the land by contour terracing or bunding. In low-lying areas and rice fields, form mounds to a height of at least 1 m above water level. In reclaimed kaval areas, planting can be done on the field bunds.

The size of pits for planting would depend upon soil types and water table. In loamy soils with low water table, pit size of 1 m x 1 m x 1 m is recommended. In laterite soils with underlying rock, take larger pits of size 1.2 m x 1.2 m x 1.2 m. In sandy soils, the size of pits may be 0.75 m x 0.75 m x 0.75 m. The pits may be filled up with top soil to a height 60 cm below the ground level. In low lying lands, take shallow pits and as the plant grows, raise the ground level by adding silt and sand so as to cover the entire bole of the palm. The same procedure can be adopted when planting is done on mounds or bunds. Burial of two layers of husks in the pits will be useful for moisture conservation. The husk is to be buried in layers with concave surface facing upwards.

Note: In lateritic areas, common salt @ 2 kg per pit may be applied on the pit to improve soil conditions. Common salt is to be applied about six months prior to planting.

#### Spacing

Spacing depends upon the planting system, soil type etc. In general, spacings are recommended under different systems in sandy and laterite soils as given in Table 22. In lateritic gravelly soils, under rainfed conditions of north Kerala, a closer spacing to accommodate 250 palms per ha is more economical.

In the hedge system of planting, the rows should be aligned in north-south direction and the seedlings planted as in the triangular system.

#### Time of planting

Planting the seedlings during May, with the onset of pre-monsoon rains is ideal. Under assured irrigation, planting can be done during April also. In low-lying areas, plant the seedlings in September after the cessation of heavy rains.

#### Shading and irrigation

For the first two years from planting, irrigate @ 45 litres of water per seedling, once in 4 days, during dry summer months. Provide adequate shade to the transplanted seedlings.

#### Manuring young palms

For the first three years after planting under rainfed conditions, apply fertilizers in two split doses at the rates shown in Table 23. Fertilizer requirement of adult palms is given in Table 24.

Table 22. Spacing for coconut

Planting system	Spacing	Approximate number of plants ha <sup>-1</sup>
Triangular	7.6 m	198
Square	7.6 m to 9 m	170-120
Single hedge	5 m in the rows 9 m between the rows	220
Double hedge	5 m x 5 m in rows 9 m between pairs of rows	280

Table 23. Fertilizer requirement of young palms in relation to that of adult palms

Time after planting	Time of application	
	April-June	Sept-Oct.
	(Proportion of adults palm dose)	
3 months (1/10 <sup>th</sup> of full dose)		1/10
1 year (1/3 <sup>rd</sup> of full dose)	1/9	2/9
2 year (2/3 <sup>rd</sup> of full dose)	2/9	4/9
3 year onwards (full dose)	3/9	6/9

Table 24. Fertilizer recommendation for coconut

	Quantity (kg/palm/annum)		
	N	P <sub>2</sub> O <sub>5</sub>	K <sub>2</sub> O
1. General recommendation			
(a) Average management	0.34	0.17	0.68
(b) Good management	0.50	0.32	1.20
2. For reclaimed clayey soils (as in Kuttanad)	0.25	0.35	0.90
3. Red loam soils (southern Kerala)	0.68	0.23	0.90
4. Hybrids & high yielding palms			
(a) For irrigated areas	1.00	0.50	2.00
(b) For rainfed conditions	0.50	0.32	1.20

Note: Under irrigated conditions, the fertilizers can be applied in 3-4 equal split doses. In the case of low lying areas, apply fertilizer after water table recedes in one single dose or in two split doses as conditions permit. In all types of soils that are low in organic matter content (except reclaimed clayey soils and alluvial soils), apply organic matter @ of 15-25 kg per palm per year during June-July from the second year of planting.

#### Weeding and interculture

Keep the pits free of weeds by periodical weeding. Remove the soil covering the collar of seedlings. As the seedlings grow fill up the pits gradually by cutting the sides. Proper intercultivation provides control of weeds and creates soil mulch. Any tillage system (ploughing, digging, raking or forming mounds) that provides soil mulch and control weeds may be followed depending upon local conditions. For laterite, sandy and red sandy loam soils give two ploughings or diggings in May-June and September-October and one raking in January. In areas where surface run off is more, form mounds in September-October and level them in November-December.

Drought management in coconut gardens

Coconut produces nuts round the year. Therefore, adequate supply of water is essential for its proper growth. Soil moisture is essential for the absorption of nutrients by roots. Moisture stress leads to stunted growth, drooping of leaves, immature nut fall and decreased yield. Importance may be given on the following aspects so as to ward off stress:

#### 1. Husk burial for moisture conservation

Burying of fresh or dried coconut husk around the palm is a desirable practice particularly for moisture retention. The husk can be buried either in linear trenches taken 3 m away from the trunk between rows of palms or in circular trenches taken around the palm at a distance of 2 m from the trunk. The trenches may be of 0.5 m width and depth. The husks are to be placed in layers with concave surface facing upwards and covered with soil. The beneficial effect of husk burial will last for about 5-7 years. Instead of husk, coir pith can be buried @ 25 kg per palm per year.

#### 2. Mulching

Mulching is an effective method of conserving soil moisture. Mulch the coconut basins with green / dry leaves at the close of

northeast monsoon (October-November). Mulching also adds organic matter to the soil and reduces the soil temperature. Do not disturb soil in the coconut garden during summer months. In level lands, during rainy seasons excess water may be conserved in small trenches dug out in the plantation. In sloppy areas, land may be terraced and trenches dug across. This will facilitate maximum percolation of rainwater and water conservation. For moisture conservation, lowest 3-5 leaves may be cut and removed. Provide adequate shade for the transplanted seedlings for 1-2 years. To minimize the sun scorch on the trunk, application of lime solution on the trunk up to a height of 2-3 m at the start of the summer season is recommended.

### 3. Green manure and cover crops

Green manure and cover crops recommended for cultivation in coconut gardens are:

- a. Green manure crops: *Crotalaria juncea* (sunhemp), *Tephrosia purpurea* (kolinji), *Indigofera hirsuta*, *Pueraria phaseoloides*
- b. Cover crops: *Calapagonium muconoides*, *Mimosa invisa*, *Stylosanthes gracilis*
- c. Shade-cum-green manure shrub: *Tephrosia candida*

Sow cowpea seeds more towards the periphery of basins taken at a radius of 2.0m from the base of the palm for green manure during April-May with the onset of pre-monsoon rains. When a few plants start flowering, uproot the entire plants and incorporate into the soil during August-September and cover the basins with soil.

Sow green manure and cover crop seeds during April-May with the onset of pre-monsoon rains. The green manure crops should be ploughed in and incorporated into the soil during August-September. This will

increase the water holding capacity of soil. *Calapagonium* can be grown either as green manure or cover crop. *Tephrosia* is especially suited for planting around seedling pits for summer shade and as a source of green manure in the rainy season.

### Manuring of adult palms

The nutrient dosages recommended for adult palms are given in Table 24.

1. Under irrigated conditions, fertilizers can be applied in 3-4 equal split doses.
2. In the case of low-lying areas, apply fertilizers in one single dose after water table recedes or in two split doses as conditions permit.
3. The application of organic materials such as forest leaves, cattle manure, coir dust or coconut shredding at 10 kg per pit in the first three years and 15-25 kg thereafter will be useful to obtain better establishment of coconut palms in sandy soils and in coastal situations.
4. In situations where the available  $P_2O_5$  status of the soil is more than 10 ppm, application of phosphatic fertilizers can be skipped for a few years until the status of  $P_2O_5$  reaches 10 ppm.
5. For sandy and sandy loams of Onattukara and similar situations and also for hybrid palms grown in root (wilt) affected areas, apply 500 g N + 300 g  $P_2O_5$  + 1000 g  $K_2O$  along with 500 g  $MgSO_4$  per palm per year.
6. Application of  $MgSO_4$  to coconut palms earlier confined to root wilt affected areas is recommended for the whole state.
7. The N: $P_2O_5$ : $K_2O$  recommendation given for high yielding palms is, in general, sufficient for palms yielding upto 100 nuts per year. For palms yielding more than 100 nuts per year, an additional dose of 10 g N,

5 g  $P_2O_5$  and 15 g  $K_2O$  may be supplied for every nut exceeding 100 nuts.

8. In laterite soils, 50 per cent of the  $K_2O$  requirement of coconut can be substituted by  $Na_2O$  supplied in the form of sodium chloride.

Time, frequency and method of fertilizer application

Under rainfed conditions, apply fertilizers in two split doses, 1/3 at the time of early southwest monsoon showers in April-June and 2/3 in September-October.

Under irrigated conditions, apply fertilizers in three or four equal doses in April-May, August-September, December and February-March.

Apply lime or dolomite during April-May, magnesium sulphate during August-September and organic matter during June-July. For an adult palm 1.0 kg dolomite or 1.0 kg lime + 0.5 kg  $MgSO_4$  is required per annum.

Apply fertilizers and manures in circular basins at a radius of 2.0 m from the base of the palm and 10 cm deep, opened after the onset of southwest monsoon. Split doses can be applied with irrigation water in summer months.

Recycling of palm waste

Recycling of palm waste is very much beneficial especially for maintaining the availability status of micronutrients and trace elements. Palm wastes like coconut leaves, crown waste, dried spathes, husk etc. may be deposited in a small trench of convenient length, 0.5 m to 0.75 m wide and 0.3 to 0.5 m deep at a distance of 2-2.5 m away from the base of the trunk. Fill up this trench with the palm wastes along one side of the palm (north) in one year, opposite side (south) in the next year, east in the third year and so on.

This practice of organic recycling of waste has been found to improve the growth and productivity of the palms.

Intercropping and mixed cropping

Schedules for inter/mixed cropping may be drawn up based on the canopy size, age and spacing of palms. In general, palms in the age group of 8-25 years are not suitable for inter and mixed cropping. However, cereals and tapioca are recommended as intercrops in young coconut plantation upto 3-4 years. Since ginger and turmeric are shade tolerant crops with shallow roots, they can be intercropped in coconut garden even in the age group of 15-25 years. It ensures better land utilization, solar energy harvesting, efficient water use, utilization of soil nutrient resources, more returns and an insurance against crop failure. Under conditions of wider spacing i.e. beyond 7.6 m, intercropping is possible irrespective of the age of the palms.

The following crops are recommended as intercrops.

Cereals: Rice, maize

Legumes and pulses: Groundnut, horse gram, cowpea.

Tubers: Tapioca, sweet potato, yams, colocasia.

Spices and condiments: Ginger, turmeric, chilly, pepper, nutmeg, cinnamon, clove.

Fruit plants: Banana, pineapple, papaya. (Banana variety Palayankodan is recommended in the reclaimed soils of Kuttanad. Three suckers per clump have to be retained).

Beverage crop: Cocoa

Fodder grasses: Hybrid Napier, guinea grass.

In all cases, separate application of adequate fertilizers and manures to the individual crop is essential.

Casuarina (*Casuarina equisetifolia*) may be planted as single row intercrop, between rows of coconut during the first year of planting coconut seedlings in pits of size 30 cm x 30 cm x 30 cm spacing of 2m. The casuarina poles will be ready for felling/harvesting within 5-6 years of planting.

Crop cafeteria for multiple cropping in coconut garden

Perennials: Cocoa, nutmeg, pepper, clove, lemongrass and cinnamon.

Annuals:

- a. Kharif: Rice, maize, groundnut, ginger, turmeric, chilli, yams, colocasia, red gram, vegetables, sweet potato, tapioca, banana, pineapple, papaya and fodder grass.
- b. Rabi: Sesame, horse gram, red gram, vegetables, cowpea, sweet potato and banana.
- c. Summer: Vegetables

Irrigation

Irrigate the palms during summer months in basins around palms as shown in Table 25 & 26.

Note: In coastal sandy soils, seawater can be used for irrigation. In irrigated gardens, interruption of irrigation would lead to serious set back in yield and general condition of palms. Hence, when once started, irrigation should be continued regularly and systematically. In sandy loam soil, irrigating the crop with 500 litres of water through basin taken at 1.5 m radius at CPE value of 50 mm (approximate interval of 15 days) is most economical. Do not irrigate seedlings and very young palms with seawater.

Drip irrigation

In the traditional system of irrigation followed in coconut gardens such as flood irrigation, basin irrigation etc. irrigation efficiency is only 30 to 50 per cent due to considerable wastage of water. In addition, cost on inputs like labour and energy in adopting these systems are high. Scarcity of water and increasing cost of labour and energy are deterrents in adopting these traditional irrigation systems. Under these circumstances, drip

Table 25. Irrigation requirement of coconut

Parameters	Soil texture			
	Sandy	Sandy loam	Loam	Silty clay
Available soil moisture (cm/m)	8	12	17	21
Quantity of water/irrigation/palm in litres in a basin of 1.8 m radius	600	900	1300	1600
Frequency of irrigation (days)				
All areas in Kerala except north eastern portion of Thrissur and Palakkad districts	3-4	5	7-8	9
North eastern portion of Thrissur and Palakkad districts	2-3	3-4	5-6	6-7

Table 26. Irrigation recommendation for Coconut on Agro Ecological Unit (AEU) basis

Parameters	Agro Ecological Zones*				
	I Coastal Plains	II Midland laterites	III Foot hills	IV High hills	V Palakkad plains
Quantity of Water/irrigation/ palm in litres in a basin of 1.8 m radius **	350 to 800	500 to 800	600 to 800	500 to 850	600 to 800
Irrigation interval in days**	3 to 7	3 to 7	4 to 7	3 to 9	3 to 6

\*NBSSLUP classification (Nair et al., 2012).

\*\* The lower values are for sandy soils and higher values are for clayey soils. Intermediate values can be chosen based on the texture of the soil with values moving towards lower side for increasing sand content and vice versa for increasing clay content. Add 30 to 40% to the above values depending upon the conveyance and application efficiencies in irrigation.

irrigation is the most suitable system of irrigation to coconut. Some of the major advantages of drip irrigation are: it saves water, enhances plant growth and yield, saves energy and labour; most suited for soils having low water holding capacity and undulating terrain, reduces weed growth and improves efficiency of fertilizers. For coconut, generally, three to four drippers are given per palm. The water requirement for an adult palm is 40 to 50 litres per day.

#### D x T hybrid production

The following guidelines are suggested for large scale production of D x T hybrid seedlings. Assisted pollination should be done to get maximum hybrid nut production. As far as possible use prepotent palms as parents in the hybridization programmes.

#### Selection of mother palms

Palms with the following phenotypic character combination may be selected for hybridization work.

1. Nuts without ridges and having yellow, orange or red colour.
2. Palms with overlapping female and male phases.
3. Small crown and canopy compared to that of tall palm.

4. Narrow stem without any bulging at the base with close leaf scars.

#### Hybridization

1. Use mixed pollen from identified tall palms.
2. Emasculate the inflorescence by cutting the male flowers with scissors and stripping if necessary within 5-7 days of opening the spathe.
3. Cloth bags made of very close mesh should be used for covering the inflorescence.
4. Hairy caterpillar larvae cause serious damage by boring into the female flowers and developing buttons through stigmatic ends. The damage is more serious under bagged conditions.
5. Dusting of pollen-talc mixture in 1:9 proportion using pollen dispensers is recommended.
6. Assisted pollination for at least 3-5 days on each inflorescence till last female flower becomes receptive and fully pollinated.
7. Remove bags after the seventh day of pollination of the last female flower.

#### Nursery

The nuts should be harvested before it is tree-ripe and sown immediately in the bed



without storage. Nursery beds should be mulched or shaded and watered regularly and adequately.

#### Button shedding

The shedding of buttons in the coconut is attributed to the following reasons.

1. Pathological conditions
2. Attack of insect pests
3. Nutritional deficiencies
4. Soil and climatic variations
5. Defects in pollination and fertilization
6. Structural defects in the flower
7. Abortion of embryos
8. Limited capacity of the tree to bear fruits
9. Unfavourable conditions such as deficit of moisture, waterlogging and lack of aeration.

The causes of button shedding may be identified and appropriate remedial measures adopted.

#### Plant protection

##### Pests

Rhinoceros beetle (*Oryctes rhinoceros*)

##### Symptoms

The adult beetle bores into the unopened fronds and spathes. The attacked frond when fully opened shows characteristic triangular cuts.

##### Management

1. Provide field sanitation to prevent breeding of beetles.
2. Hook out the beetles from the attacked palms by using beetle hook.
3. The topmost three leaf axils around the spindle may be filled with any of the following mixtures as a prophylactic measure:
  - a. Application of 250 g neem cake or marotti (*Hydnocarpus wightiana*) cake mixed with equal volume of sand in the

innermost 2-3 leaf axils. This treatment is to be done twice, i.e., during April-May before the onset of south-west monsoon and during September-October after the south-west monsoon.

- b. Naphthalene balls 12.0 g (approx. 4 nos.) in the innermost 2 leaf axils and covered with fine sand, once in 45 days.
- c. Incorporation of *Clerodendron infortunatum* @ 10 per cent w/w basis in the cowdung pit and/or manure pits.
4. Crown cleaning followed by the application of 20g Cartap hydrochloride 4G or Fipronil 0.3G or carbosulfan 6G mixed with 200 g sand in the innermost 2-3 leaf axils. This treatment has to be done thrice during January, May and September.
5. Release Baculovirus oryctes infected adults @ 10-15 ha<sup>-1</sup> to bring down the pest population.
6. Inoculation of breeding sites with entomopathogenic fungus *Metarrhizium anisopliae* (@ 5 x 10<sup>11</sup> spores / m<sup>3</sup>) var major causes mortality to the grubs.

##### Red palm weevil

(*Rhyncophorus ferrugineus*)

##### Symptoms

The diagnostic symptoms are the presence of holes on the stem, oozing out of a viscous brown fluid and extrusion of chewed up fibrous matter through the hole, longitudinal splitting of leaf base and wilting of central shoot. Sometimes the gnawing sound produced by the feeding grubs inside will also be audible.

##### Management

1. Field sanitation should be given prime importance.
2. Avoid making steps or any other injury on the tree trunks to reduce the loci of infestation.

3. Leaf axil filling as suggested in the case of rhinoceros beetle will be useful against the red palm weevil also.
4. When green leaves are cut from the palms, stumps of not less than 120 cm may be left on the trees in order to prevent successful inward movement of the grubs through the cut end.
5. In attacked palms, observe for the boreholes and seal them except the top most one. Through the top most hole, pour 1 per cent carbaryl or 0.15 per cent trichlorphon suspension @ one litre per palm, using a funnel.
6. When the pest infestation is through the crown, clean the crown and slowly pour the insecticidal suspension.
7. As an alternative, apply 1 per cent DDVP as a curative measure.
8. Coconut log traps with fermenting toddy or pineapple or sugarcane activated with yeast or molasses can be set in coconut plantation to attract and trap the free floating population of red palm weevil. Incorporate any of the insecticide to each trap to kill the weevils trapped.
9. Use of pheromone trap for attracting and killing adult weevils @ one trap per 2 ha.

#### Leaf eating caterpillar (*Opisina arenosella*)

##### Symptoms

The caterpillar feeds on green matter from the lower leaf surface, remaining within galleries of silk and frass. The attack will be severe during summer months from January-May.

##### Management

1. As a prophylactic measure, the first affected leaves may be cut and burnt during the beginning of the summer season.
2. Arrange for the release of larval / pupal parasitoids, *Goniozus nephantidis*, *Elasmus nephantidis* (brown species) and *Brachymeria nosatoi*.

3. Trunk release of *G.nephantidis* @ 10 nos/plam (4 to 6 releases) is effective for the management of leaf eating caterpillar.
4. When infestation is very severe and if the biocontrol is not likely to be effective, spray the undersurface of the fronds with dichlorvos 0.05 per cent, malathion 0.1 per cent, quinalphos 0.05 per cent or phosalone 0.07 per cent.
5. When the infestation is very severe and if the biocontrol is not likely to be effective, spray the under surface of the fronds with dichlorvos 0.05 per cent, malathion 0.1 per cent, quinalphos 0.05 per cent, phosalone 0.07 per cent, Flubendiamide 39.35 SC (0.2 ml l<sup>-1</sup>), Chlorantraniliprole 18.5% SC (0.5 ml l<sup>-1</sup>). Spinosad 45 SC (0.4 ml l<sup>-1</sup>) is also effective.

Note: Application of the insecticides should be followed by liberation of larval and pupal parasites from the 21<sup>st</sup> day.

#### Cockchafer beetle

(*Leucopholis coneophora*)

##### Symptoms

The soil inhabiting white grubs cause damage to the roots of coconut palm. The attack is common in sandy tracts. The infested palms turn pale yellow and there will be considerable reduction in yield.

##### Management

1. Collection and destruction of adults during the monsoon period from adjacent vegetation (in the evening).
2. Plough or dig the infested soil synchronizing with pre-monsoon showers.
3. Drench the soil with chlorpyrifos 0.04 per cent suspension. The treatment should be given twice, first during April-May after the receipt of pre-monsoon showers and second during the month of September.

Note: Wherever possible, light traps may be set up to attract and trap adult beetles.

### Coreid bug (*Paradasynus rostratus*)

#### Symptoms

The attacked buttons become deformed with characteristic crevices on the husk below the perianth with gum exudations and the tender nuts become barren.

#### Management

Apply 0.1 per cent Dimethoate 0.05% on the newly opened inflorescence after the receptive phase of the female flowers and spray the entire crown excluding the leaves and older bunches.

Note: The insecticide may be applied according to the severity of infection in a need-based manner.

### Coconut eriophyid mite

#### (*Aceria guerreronis*)

It is a microscopic worm like mite infesting young buttons colonizing under the perianth.

#### Symptoms

The earliest symptoms on 2-3 months old button is pale yellow triangular patches seen below the perianth. Later, these patches become brown. Severely affected buttons may fall. As the buttons grow, brown patches lead to black necrotic lesions with longitudinal fissures on the husk. Uneven growth results in distortion and stunting of nuts leading to reduction in copra yield. In severe cases, the losses are compounded because the quality of fibre is reduced and distorted nuts increase the labour requirements for dehusking.

#### Management

1. Collect and destroy all the fallen buttons of the affected palm.
2. Apply 2 per cent neem oil + garlic emulsion or commercial neem formulation azadirachtin 0.004 per cent (Neemazal T/S 1 per cent @ 4 ml per litre of water) or micronized wettable sulphur 0.4 per cent in the crown on young bunches. When rocker sprayer is used 1.0 to 1.5 litres of spray fluid per palm is required. If a hand sprayer is used, the spray solution required

may be about 500 to 750 ml. Spraying has to be done on second to seventh bunches from top avoiding unpollinated inflorescence. Care should be taken to see that spray fluid reaches the perianth region of third, fourth and fifth bunches since these bunches harbour maximum number of mites. Three rounds of spraying are recommended in a year viz., March-April before the onset of southwest monsoon, in August-September during the dry spell between the southwest and northeast monsoons and in December-January after the northeast monsoon so that all the emerging bunches in the vulnerable stage receive one round of spraying. Rational rotation of the above pesticides may be adopted to avoid chances of resistance.

#### Preparation of neem oil + garlic emulsion (2 per cent)

To prepare 10 litres of 2 per cent neem oil + garlic emulsion, 200 ml neem oil, 200 g garlic and 50 g ordinary bar soap are required. Slice the bar soap and dissolve in 500 ml lukewarm water. Grind 200 g of garlic and take the extract in 300 ml of water. Pour the 500 ml soap solution in 200 ml neem oil slowly and stir vigorously to get a good emulsion. Mix the garlic extract in the neem oil + soap emulsion. Dilute this 1 litre stock solution by adding 9 litres of water to get 10 litres of 2 per cent neem oil + garlic emulsion.

As per the recommendation of the National Level Steering Committee, a holistic approach has to be adopted in the management of the coconut eriophyid mite. Hence, in addition to the plant protection measures mentioned above, the following measures can be adopted:

1. Improving nutrient status by applying organic manure at the rate of 50 kg and neem cake 5 kg per palm per year. Also apply the recommended dose of fertilizers in two split applications.
2. Growing compatible intercrops / mixed crops.
3. Providing adequate irrigation.

## Mealy bug

### Symptoms

Mealy bugs infest the unopened heartleaf and inflorescence. As a result, the leaves become highly stunted, suppressed, deformed and present a crinkled appearance. It is often confused with the leaf rot symptoms. The affected inflorescences are malformed and do not open. Even if they open, they do not bear nuts.

Button mealy bugs colonize under the perianth lobes of tender nuts. Infested nuts harbouring gravid mealy bugs remain on the spadix, which serve as inoculum for further spread.

### Management

Remove and destroy all dried up inflorescence and unproductive buttons. Apply non-residual phosphatic insecticide dimethoate 0.05 per cent or quinalphos 0.05 per cent at the site of infestation. Neem garlic emulsion 2 per cent applied on infested bunches checks button mealy bugs.

### Rodents

Rats damage tender nuts by forming characteristic holes. Shed nuts can be seen at the base of the palm.

Place wax blocks of 0.005 per cent bromadiolone in coconut crown of the infested palms at 3 to 4 days interval till the bait is no more consumed.

## Diseases

### Phytophthora diseases

Phytophthora palmivora has been found to affect seedlings and adult palms causing bud rot and immature nut fall commonly known as mahali.

### Bud rot

### Symptoms

Palms of all age are liable to be attacked but normally young palms are more susceptible, particularly during monsoon when the temperature is low and humidity is very high.

In seedlings, the spear leaf turns pale and comes off with a gentle pull. In adult palms, the first visible symptom is the colour change of the spear, which becomes pale and breaks at the base and hangs down. The tender leaf base and soft tissues of the crown rot into a slimy mass of decayed material emitting a foul smell. The rotting slowly progresses downwards, finally affecting the meristem and killing the palms. This is accompanied by drooping of successive leaves. Even then, nuts that are retained on the palm may grow to maturity. The disease proves fatal if not checked at the early stages, before damage of the bud.

### Management

1. In early stages of the disease (when the heartleaf starts withering) cut and remove all affected tissues of the crown. Apply Bordeaux paste and protect it from rain till normal shoot emerges.
2. Burn all disease-affected tissues removed from the palm.
3. Spray 1.0 per cent Bordeaux mixture on spindle leaves and crown of disease affected as well as neighbouring palms, as a prophylactic measure. Palms that are sensitive to copper containing fungicides can be protected by mancozeb. Small, perforated sachets containing 2 g of mancozeb may be tied to the top of leaf axil. When it rains, a small quantity of the fungicide is released from the sachets to the leaf base, thus protecting the palm.
4. Adopt control measures for rhinoceros beetle.
5. Provide adequate drainage in gardens.
6. Adopt proper spacing and avoid over crowding in bud rot prone gardens.

## Mahali

### Symptoms

Shedding of female flowers and immature nuts are the common symptoms of the disease. Lesions appear on the young fruits or buttons

near the stalk, which later lead to the decay of the underlying tissues and endosperm.

#### Management

Spray 1.0 per cent Bordeaux mixture or copper oxychloride preparation ( $2 \text{ g l}^{-1}$ ) on the crown of palms, once before the monsoon and once or twice later on at intervals of 40 days.

#### Root (wilt) disease

##### Symptoms

The characteristic symptom is the flaccidity of leaflets. Yellowing of older leaves, necrosis of leaflets and deterioration and decay of root system are other salient features of the disease. The leaflets curve inwardly to produce ribbing so that the whole frond develops a cup like appearance. Abnormal shedding of buttons and immature nuts are also noticed.

##### Management

Coconut root (wilt) is a non-lethal debilitating disease and the affected palms survive for a long period giving a reasonably good yield. The root (wilt) affected palms are susceptible to diseases like leaf rot and pests like rhinoceros beetle and red palm weevil. So there is a chance of confusing the pests and disease symptom with the root (wilt) disease. Negligence on the management aspects aggravates the malady. Efficient management of palms suspected to be affected by coconut root (wilt) disease demands control of all pests and diseases and imparting natural resistance and health to the palms through proper manuring and agronomic practices. A package of management practices for the effective management of root (wilt) disease is given below:

1. Rogue out palms that are affected severely by root (wilt) and yield less than 10 nuts / palm / year and those, which have contracted the disease before flowering. Replant with disease tolerant material / high yielding hybrids (Chandrasankara).
2. Apply fertilizers for coconut palms in average management at the rate of 0.34 kg N, 0.17 kg  $\text{P}_2\text{O}_5$  and 0.68 kg  $\text{K}_2\text{O}$  / palm / year in the form of urea, rock phosphate and muriate of potash, respectively. For palms under good management, fertilizers may be given @ of 0.5 kg N, 0.32 kg  $\text{P}_2\text{O}_5$  and 1.2 kg  $\text{K}_2\text{O}$  / palm / year.
3. In addition to the above, apply 50 kg cattle manure or green manure and 1 kg of lime/palm/year. Magnesium may be supplied @ 500 g MgO per palm per year in the Onattukara region (sandy soil) and 100 g MgO in the remaining areas. The cheapest source of MgO is magnesite ( $\text{MgCO}_3$ ). The magnesium in magnesite is acid soluble. Hence it may be preferred in acid soils.
4. Growing green manure crops like sun hemp, sesbania, cowpea and calapagonium in the coconut basin and their incorporation in situ is beneficial as the practice reduces the intensity of the root (wilt) and increases the nut yield. The ideal green manure crops for the sandy and alluvial soils are cowpea and sesbania, respectively.
5. Under rainfed conditions, apply fertilizers in two splits,  $1/3^{\text{rd}}$  at the time of early southwest monsoon and  $2/3^{\text{rd}}$  before the northeast monsoon. Under irrigated conditions apply fertilizers in three equal splits (April-May, August-September and December-January).
6. Apply fertilizers and manures in 10 cm deep circular basins at a radius of 2 m from the bole of the palm.
7. When the crop is grown under the bund and channel system, desilt the channel and strengthen the bunds during summer months.
8. Follow strictly all the prescribed prophylactic measures against leaf rot

disease, red palm weevil, rhinoceros beetle etc. so as to ensure that the palms are not debilitated. To maintain the productivity of the palms, prophylactic measures are of great importance.

#### Leaf rot

##### Symptoms

The first symptom is the appearance of water-soaked brown lesions in the spear leaves of root-wilt affected palms. Gradually these spots enlarge and coalesce resulting in extensive rotting. As the leaf unfurls, the rotten portions of the lamina dry and get blown off in wind, giving a 'fan' shape to the leaves. Some times, the symptom becomes very acute and the spear fails to unfurl.

This disease is a fungal complex initiated predominantly by *Colletotrichum gloeosporioides*, *Exserohilum rostratum* and *Fusarium* spp.

##### Management

1. Remove the rotten portions from the spear and the two adjacent leaves.
2. Pour 300 ml of fungicidal solution at the base of the spear. This can be prepared by mixing hexaconazole 5 EC 2 ml or mancozeb 3 g in 300 ml water.
3. Treat the top two leaf axils with insecticide preparation. This can be prepared by mixing cartap hydrochloride 20 g with 200 g sand.
4. Spray crowns and leaves with 1 per cent Bordeaux mixture or copper oxy chloride formulations (2 g l<sup>-1</sup>) or mancozeb (3 g l<sup>-1</sup>) in January, April-May and September. While spraying, care has to be taken to spray the spindle leaf.
5. After crown cleaning (removal and destruction of affected parts) in coconut palms pour 300 ml of any of the following bio-control agent at the base of spear

leaves twice a year (April-May and September-October) 1. *Pseudomonas fluorescens* (20 g l<sup>-1</sup>) or 2. PGPR mix II (20 g l<sup>-1</sup>).

#### Stem bleeding

##### Symptoms

Exudation of the reddish brown liquid through the growth cracks mostly at the basal part of the trunk and bleeding patches higher up in the trunk are characteristic symptoms. One or more lesions, lying close by, may coalesce to form large patches. The liquid that oozes out dries up and turns black. The tissues beneath the bleeding points decay and become yellowish. The lesions spread upwards as the disease progresses. In advanced stages, the leaf size reduces leading to reduction in crown size. The rate of leaf production slows down. The production of bunches is affected and nut shedding takes place. The trunk gradually tapers towards the apex. The progress of the disease is faster during July to November.

##### Causal organism

The fungus, *Thielaviopsis paradoxa* is the causal agent. Growth cracks on the trunk, severe summer followed by heavy down pour, water stagnation, imbalance in nutrition, excess salinity and stress can act as predisposing / aggravating factors.

##### Management

1. Chisel out completely the affected tissues and paint the wound with Bordeaux paste. Apply coal tar after 1-2 days.
2. Destroy the chiseled materials by burning. Avoid any mechanical injury to trunk.
3. Apply neem cake @ 5 kg per palm in the basin along with other organics.
4. Apply hexaconazole @ 25 ml in 25 litre of water as soil drenching once in four months.
5. Swabbing the lesions on the trunk with a paste of *Trichoderma viride* talc based

formulation (100 g 100 ml<sup>-1</sup>) along with application of lime or dolomite @ 1 kg palm<sup>-1</sup> during April-May and application of neem cake (5 kg palm<sup>-1</sup>) + organic manure enriched with *Trichoderma viride* (1%) during September-October.

#### Grey blight

This is caused by the fungus *Pestalotia palmarum*.

#### Symptoms

Symptoms appear in the mature leaves of the outer whorl as yellow specks encircled by a greyish band which later become greyish white. The spots coalesce into irregular necrotic patches causing extensive leaf blight. In advanced stages, the tips and margins of the leaflets dry and shrivel giving a burnt appearance.

#### Management

Remove severely affected older leaves and burn. Spray the trees with 1 per cent Bordeaux mixture or propiconazole @ 1 ml l<sup>-1</sup>.

#### Tanjore wilt

#### Symptoms

This disease is of recent occurrence in many parts of Kerala, especially in the districts of Palakkad, Malappuram, Thrissur, Kollam, Thiruvananthapuram and Wayanad. Middle aged palms were seen fatally affected. The characteristic symptom of the disease is the rotting of the basal portion of the stem. The bark turns brittle and often gets peeled off in flakes, leaving open cracks and crevices. The internal tissues are discoloured and disintegrated, emitting a bad smell. Mild bleeding occurs on the basal region. The tissues on the bleeding spots are soft to touch. Extensive damage of the root system following root rotting has been observed. Ultimately the palm dies off.

#### Management

1. Apply organic manure @ 50 kg palm<sup>-1</sup>.
2. Apply neem cake @ 5 kg palm<sup>-1</sup> year<sup>-1</sup>.
3. Reduce fertilizer application to one-fourth of the recommended dose.
4. Drench the basin with 40 litres of any copper fungicide to soak soil up to 15 cm depth at quarterly intervals.
5. Avoid flood irrigation in order to prevent the possible spread of the pathogen through soil.
6. Isolate the affected palm from the healthy ones by digging a trench of size 1 m deep and 50 cm wide, 1.5 m away from the bole of the infected palm.
7. Avoid growing leguminous crops in and around the garden.

#### Safe storage of copra

Copra obtained from commonly cultivated varieties/ cultivars is attacked by various insect pests in store. Among these ham beetle, *Necrobia rufipes* and saw toothed grain beetle, *Oryzophilus surinamensis* are of major importance, which can cause more than 15 per cent loss to copra when stored for more than six months.

Following precautions are to be taken for the safe storage of copra for more than three months:

1. Dry the produce to 4 per cent moisture content.
2. Avoid heap storage, which causes maximum damage.
3. Store copra in netted polythene bags or gunny bags.

#### Shell fired copra dryer

A new type of dryer working on indirect heating and natural convection principles using coconut shell as fuel has been designed and developed by CPCRI. The overall dimension

of the dryer is 2.25 m length, 1.5 m breadth and 1.5 m height. The capacity of the dryer is 1000-1200 nuts per batch. The dryer has two heating chambers which are arranged in parallel. Specially developed rolling in type of fuel trays are used for burning the fuel. The dryer consists of a drying chamber; a burning chamber; a plenum chamber and ventilation holes. Each full tray produces heat for 6 hours, with a temperature of about 80-82°C. Generally after 6 hours, when the temperature drops below 60°C, the fuel trays are removed

from the dryer, cleaned and reloaded with fuel, refired and replaced into respective burning chambers. About 4 loads of fuel are required with a capacity of 80 shells per tray to dry the copra to about 6.25 per cent moisture content. The total drying time is 24 hours. The cost of the dryer is approx Rs.35,000/-. Farmers and entrepreneurs interested to purchase this dryer can contact, Agricultural Technology Information Centre (ATIC), CPCRI, Kasaragod, for further details.

## GROUNDNUT (*Arachis hypogaea*)

Groundnut can be cultivated as a floor crop in coconut gardens, as an intercrop with tapioca and as a catch crop after second crop paddy with irrigation. The crop is grown best in sandy loam and loam soils.

Season

Rainfed : May-June to September-October

Irrigated : January to May

Varieties

	Duration (days)
TMV-2 (bunch type)	110
TMV-7 (bunch type)	110
TG-3 (bunch type)	100-110
TG-14 (bunch type)	105-115
Spanish Improved	100-110
Sneha (bunch type)	Early
Snigtha (bunch type)	Early

Note: TG-3, TMV-2 and TMV-7 are recommended as intercrops in coconut gardens.

Seeds and sowing

Pure crop	100kg kernels ha <sup>-1</sup>
Intercrop in coconut	80 kg kernels ha <sup>-1</sup>
Intercrop in tapioca	40-50 kg kernels ha <sup>-1</sup>

Plough the field three or four times into a fine tilth. Sow the seeds by dibbling in ploughed furrows at a spacing of 15 cm x 15 cm. For seed treatment the rhizobial culture is recommended.

Manuring

Cattle manure or compost	2 t ha <sup>-1</sup>
Lime	1-1.5 t ha <sup>-1</sup>
Fertilizers N:P <sub>2</sub> O <sub>5</sub> :K <sub>2</sub> O	10:75:75 kg ha <sup>-1</sup>

Apply entire quantity of cattle manure or compost and recommended quantity of fertilizers as basal dressing and incorporate well into the soil. Apply lime at the time of flowering of the crop and mix with the soil by light hoeing or raking.

Irrigation and interculture

Irrigate the crop once in 7 days. Weed the crop 10-15 days after germination of seed by light hoeing. Give another light hoeing or



raking at the time of application of lime. Do not disturb the soil after 45 days of sowing.

#### Plant protection

Red hairy caterpillar, termites and leaf miners are the major pests of groundnut. Against leaf miner apply any of the organophosphorus insecticides with contact action.

Tikka leaf spot disease infects both the

rainfed and irrigated crops. Prophylactic spraying with Bordeaux mixture 1.0 per cent before flowering will control the disease.

#### Harvesting

The crop will be ready for harvest when the leaves start yellowing and begin to dry up. Development of brown colour inside the pods also indicates maturity of the crop.

## OIL PALM (*Elaeis guineensis*)

Oil palm grows best in areas with a mean maximum temperature of 30-32°C and on an average of at least five hours of sunlight. It can be grown in areas, which receive well-distributed annual rainfall of 200 cm or more. However, it can tolerate two to four months of dry spell. The oil palm grows on wide range of tropical soils. The adult palms can withstand occasional waterlogging, but frequently waterlogged, extremely sandy and hard lateritic soils should be avoided.

#### Varieties

The only variety recommended for commercial cultivation is Tenera, which is a hybrid between Dura and Pisifera.

#### Nursery practices

The fruits are separated from the bunch and seeds are extracted by scraping off the exocarp and mesocarp with a knife, or by retting in water. The seeds are then dried by spreading them on concrete or wooden floors under shade for two days. Such seeds can be stored for 3-9 months at about 27°C without much reduction in viability.

Seeds are soaked in water for five days, changing the water daily. Thereafter, the seeds are spread out to dry for 24 hours. The dried seeds are put in polythene bags and placed in

germinator maintained at a temperature of 40°C. After 80 days, the seeds are removed from polythene bags, soaked in water for 5 days changing the water daily and dried in the shade for two hours. The seeds are then put back into bags and kept in a cool place in order to maintain the moisture content. Germination commences in about 10-12 days. The percentage of germination obtainable by this method is 90-95.

#### Raising nursery

Polybags (preferably black) of 400-500 gauge measuring 40 cm x 35 cm are used. The bags are filled with topsoil and compost and are arranged at a spacing of 45 cm x 45 cm and one sprouted seed is dibbled per bag. A good mulching during summer is desirable. Watering the seedlings weekly thrice is recommended. A fertilizer mixture containing 15 g N, 15 g P<sub>2</sub>O<sub>5</sub> and 6 g K<sub>2</sub>O at the rate of 8 g in five litres of water for 100 seedlings may be applied when the seedlings are two months and eight months old.

#### Planting

Oil palm is planted in the main field in triangular system at spacing of 9 m accommodating 140 palms per ha. Planting is preferably done at the onset of monsoon

during May-June. The polythene bag is torn open and the entire ball of earth is buried in the pit (50 cm x 50 cm x 50 cm) and levelled.

#### Manuring

The following fertilizer schedule is considered satisfactory for oil palm.

N:P <sub>2</sub> O <sub>5</sub> :K <sub>2</sub> O	g/palm/year
First year	400:200:400
Second year	800:400:800
Third year onwards	1200:600:1200

Mg application is necessary only if deficiency symptoms are noticed. Fertilizers are preferably applied in two equal split doses (May and September), within 2 m diameter around the palm and forked in. Supply of sufficient quantities of green leaf or compost is advantageous, especially where the soil is poor in organic matter.

#### Leaf pruning

Dead and diseased leaves and all inflorescences should be cut off regularly upto three years after planting. When the palms are yielding, judicious pruning to retain about 40 leaves on the crown is advocated. It is necessary to remove some of the leaves while harvesting. In such cases, care should be taken to avoid over pruning. In addition, all dead and excess leaves should be cut off and crown cleaned at least once in a year, usually during the dry season.

#### Pollination

Oil palm is a cross-pollinated crop. Assisted pollination is done to ensure fertilization of all female flowers. However, this is not necessary if the pollination weevil

*Elaeobius kamerunicus* is introduced in the plantation. They congregate and multiply on male inflorescence during flower opening. The weevils also visit the female flowers and pollinate them effectively.

#### Harvesting

First harvest can be taken 3.5 to 4 years after planting. When a few ripe fruits are loose/fall off, the bunch is ready for harvesting. Processing over-ripe fruits reduces quantity and quality of oil.

A chisel is used for harvesting bunches from young palms. The stalk of the bunch is struck hard with the chisel to cut off and push the bunch out. When the palms become taller (from 10 year onwards) a harvesting hook has to be used. When the palms are too tall, it is necessary to climb the palms for harvesting.

#### Plant protection

##### Pests

##### Rhinoceros beetle

The pest causes severe damage to emerging fronds and spindle. The adult beetle feeds on the softer tissue of the rachis, resulting in snapping off of the fronds and spears at the feeding sites. Field sanitation and elimination of breeding sites are essential components of the pest management operation. This pest can be suppressed by using the virus *Baculovirus oryctes*.

##### Red palm weevil

This is a major pest of oil palm in India. These weevils lay their eggs at the cut end of petioles or other wounds. The emerging larvae tunnel into the crown and feed on the growing tissues. Palms infested by red palm

weevil start wilting and leaves show gradually increasing chlorosis and fracture in strong winds.

#### Birds

Many birds such as the forest crow, the house crow and the common Indian myna cause severe damage to oil palm fruit bunches. These birds feed on the mesocarp of the oil palm fruits. The damage can be minimized by scaring the birds and covering the ripe bunch with wire net, 150 days after fruit set.

#### Diseases

##### Anthracnose

This disease occurs in the nursery. It is recognized by regular or irregular brown to black leaf blotches surrounded by yellow haloes, which develop along the margin, centre or tip of the leaves. It causes heavy seedling loss. The disease can be controlled by spraying mancozeb or captan @ 200 g 100<sup>-1</sup> litres of water. Copper fungicides should not be used because of the extreme susceptibility of oil palm seedlings to copper burn (scorching).

##### Spear rot

This is noticed to affect oil palms of all ages. The incidence is less than one per cent. Yellowing starts from tip of the innermost whorl of leaves. Small lesions occur at the distal portions of spear and rotting extends downwards. As the disease advances, new leaves become rudimentary and show rotting. General decline in vigour and production is then noticed. Occurrence of spear rot without yellowing has also been noticed. Distinguishable marginal yellowing of leaflets and sudden

drying of leaves showing yellowing are other symptoms. Roguing of all the affected palms may be adopted to prevent further spread of the disease. In early stages of the disease, the affected portions of leaves may be removed and burnt.

##### Bunch failure

Sparse or no fruit set followed by complete drying or rotting of the affected bunches are the typical symptoms. The extent of incidence can be up to 20 per cent. This malady is generally attributed to excess pruning, mutual shading, underpollination, moisture stress and unhygienic conditions. The situation can be improved by assisted pollination as well as by adopting hygienic measures like removal of infected bunches and dry male inflorescence.

##### Processing

For mature plantations not exceeding 40 ha, a hand-operated hydraulic press will be enough for extraction of oil. In the case of large-scale plantations, the hydraulic press will not be economical and as such, mechanically driven oil mills have to be established. The fruit bunches brought to the factory are first quartered by means of a chisel. They are then sterilized in steam or boiling water for 30-60 minutes. The objective of this process is to inactivate the fat splitting enzymes, which are present in the fruit, which may raise the free fatty acid content of the oil and also to soften the fruits for easy pounding. The sterilized fruits are stripped off from the bunch and then pounded. The pounded fruit mass is then reheated and squeezed using a hydraulic press. It is then boiled in a clarification drum where the sludge will deposit and pure oil float over the water. The oil is then drained out.

## SESAME (*Sesamum indicum*)

Sesame grows in well-drained, sandy loam soils. Coarse sandy soils and soils of alkaline and saline nature are not suited for the crop.

### Season

Lowland paddy field: December-April (third crop)

Uplands: August-December

### Varieties

For upland cultivation use varieties with long duration of 100-110 days and for low land, use varieties with duration of 80-99 days (Table 27).

### Preparation of land and sowing

Prepare the soil into a fine tilth by ploughing 2-4 times and breaking the clods. Seed rate is 4-5 kg ha<sup>-1</sup>. Broadcast seeds evenly, preferably mixed with sand 2-3 times its volume, to ensure uniform coverage. Work with harrow, followed by pressing with wooden plank so as to cover the seed in the soil.

### Manuring

Apply manures and fertilizers at the following rates.

Cattle manure / compost: 5 t ha<sup>-1</sup>

N:P<sub>2</sub>O<sub>5</sub>:K<sub>2</sub>O: 30:15:30 kg ha<sup>-1</sup>

Apply cattle manure/compost as basal dressing and incorporate into the soil along with last ploughing. Apply fertilizers as basal dose when there is enough moisture in the soil. Urea is preferable to ammonium sulphate. Nitrogen may be applied in split doses, 75 per cent as basal and the balance as foliar spray at 3 per cent concentration, 20-35 days after sowing keeping the discharge rate at 500 l ha<sup>-1</sup>.

### Interculture

After cultivation of the crop may be done twice, first at 15 days and the next 25-35 days after sowing. When the plants are about 15 cm in height, thin the crop so as to give a spacing of 15-25 cm between plants.

Table 27. Sesame varieties

Kayamkulam-1	Suitable for lowlands of Onattukara
Kayamkulam-2 (Thilothama)	Suitable for rice fallows in Onattukara, resistant to leaf spot disease.
ACV-1 (Soma)	Pure line selection for summer fallows of Onattukara
ACV-2 (Surya)	Pure line selection suited for uplands
ACV-3 (Thilak)	Pure line selection suited to summer fallows of Onattukara
Thilathara (CST 785 x B14)	Suitable for the summer rice fallows of Onattukara, oil 51.5%, duration 78 days
OMT-1165	Suited to uplands of Onattukara (rabi season), oil 50.5%
Thilarani	Suited to summer rice fallows of Onattukara

### Irrigation

Usually the crop is grown under rainfed conditions. When facilities are available, the crop may be irrigated to field capacity after thinning operation and thereafter at 15-20 days interval. Stop irrigation just before the pods begin to mature.

Surface irrigation at 3 cm depth during the critical stages, viz., 4-5 leaves, branching, flowering and pod formation will increase the yield by 35-52 per cent. Two irrigations of 3 cm depth each in the vegetative phase (4-5 leaf stage or branching) and in reproductive phase (at flowering or pod formation) are the best, registering maximum yield and water use efficiency. In the case of single irrigation, it can be best given in the reproductive phase. In the tail end fields in command area, best use of the sparingly available water can be made for augmenting sesame production.

### Plant protection

Azadirachtin 0.03 per cent at 5 ml per litre spray at 7<sup>th</sup> and 20<sup>th</sup> DAS and thereafter need based application can manage the incidence

of leaf and pod caterpillar, pod borer infestation and phyllody incidence.

For control of leaf curl disease, remove and destroy disease affected sesame plants as well as the diseased collateral hosts like chilli, tomato and zinnia.

Remove plants affected with phyllody and destroy them. Do not use seeds from affected plants for sowing.

### Harvesting

Harvest the crop, when the capsules turn yellowish by pulling out the plants. Harvest during the morning hours. Cut the root portion and stack the plants in bundles for 3-4 days when the leaves will fall off. Spread in the sun and beat with sticks to break open the capsules. Repeat this for 3 days. Preserve seeds collected during the first day for seed purposes. Clean and dry in sun for about 7 days before storing.

### Storage of seeds

By keeping sesame seeds in polybags, tin bins, wooden receptacles or in earthen pots, the viability can be maintained for about one year. Admixture of seeds with ash will drastically reduce germination.

## SPICES AND CONDIMENTS

### CARDAMOM (*Elettaria cardamomum*)

The habitat of small cardamom is the evergreen forests of Western Ghats. It is grown in areas where the annual rainfall ranges from 1500-4000 mm with a temperature range of 10-35 °C and an altitude of 600-1200 m above MSL.

Cardamom is generally grown in forest loam soils rich in available phosphorus and potassium. The crop is raised mainly on well drained, deep, good textured soils rich in humus.

#### Varieties

ICRI-1, ICRI-2, PV-1 and PV-2. ISSR Vijetha is resistant to Katte disease and is recommended to moderate rainfall with moderate to high shaded mosaic (cardamom mosaic virus) infected areas. IISR Avinash is resistant to rhizome rot and is highly suitable for planting in valleys.

#### Cultivars

- Malabar : Suitable for areas from 600 to 1200 m elevation
- Mysore : Suitable for areas from 900 to 1200 m elevation
- Vazhukka : Suitable for areas from 900 to 1400 m elevation

#### Propagation

Cardamom can be propagated vegetatively and by seedlings. However, in Kerala where viral diseases is a serious problem seed propagation is not popular among farmers.

#### Vegetative propagation

In Kerala, vegetative propagation is commonly practiced. For vegetative propagation, rhizomes with an old shoot and a

sprout are used. Plants propagated vegetatively come to bearing one year earlier than the seedling propagated plants and are true to type.

#### Rhizome multiplication

This may be taken up from the first week of March to the first fortnight of October. The site is selected in open, gently slopping and well-drained areas near a source of water. Trenches of 45 cm width, 45 cm depth and convenient length are taken across the slope or along the contour 1.8 m apart. They are filled with equal quantity of humus rich topsoil, sand and cattle manure. Uproot a part of the high yielding disease free mother clump identified in the plantation. Trim the roots and separate the suckers so that the minimum planting unit consists of one grown up tiller and a growing young shoot. Plant them at a spacing of 1.80 m x 0.60 m in filled up trenches. Provide sufficient mulch and stake each planting unit. Provide overhead pandal as in the case of seedling nursery and remove shading material with onset of monsoon rains. Provide irrigation once in a fortnight and adopt necessary plant protection measures. Apply fertilizers @ 100:50:200 kg ha<sup>-1</sup> N:P<sub>2</sub>O<sub>5</sub>:K<sub>2</sub>O in six splits at an interval of two months. Apply neem cake @ 100-150 g/plant along with fertilizers. On an average, 20 to 30 suckers / initial planting unit can be produced within one year of planting. Care should be taken to identify and collect mother clumps only from areas totally free from 'katte' disease.

#### Main field planting

Cardamom plantation is raised in forests under the shade of tall trees. For raising a new cardamom plantation, the undergrowth of

bushes is cleared. When open areas like marshy valleys and grasslands are selected for raising new plantation, saplings of shade trees have to be raised before planting cardamom sucker. The quick growing shade trees like *Vernonia arborea* and *Toona ciliata* are generally used for this purpose. Other quick growing trees like *Albizia* can also be used. Useful trees like jack can be used along with wild nutmeg, kurangatti etc.

#### Spacing

Mysore and Vazhukka: 2 m x 2 m to 3 m x 2 m depending on the fertility of the soil.

Malabar: 1.5 m x 1.5 m to 2 m x 2 m depending on the fertility of the soil.

The recommended size of pits is 60 cm x 60 cm x 35 cm. The pits are filled with rich topsoil at least two months in advance of planting the seedlings. Application of well decomposed FYM or compost or leaf mould and 100 g of rock phosphate with the topsoil in the pit will help in proper establishment and quick growth of plants. If the selected site is a hill slope, terraces may be formed before digging pits.

Planting can be done with the commencement of southwest monsoon, before the heavy rains. A small pit may be formed inside the pit by scooping out soil at the centre of the pit for planting single tillers. The soil may be put just to cover the rhizomes. Care should be taken to ensure that the rhizomes do not go deep into the soil.

#### Cultural operations

A regular schedule of cultural practices consisting of weeding, mulching, trashing, shade regulation, fertilizer application, irrigation, etc. will have to be undertaken.

Sufficient mulch should be applied at the base of the plant during December to reduce

the ill effects of drought during summer months and to conserve soil moisture. Sickle weeding is essential which has to be carried out frequently depending upon the intensity of weeds. Forking is necessary in hard soils, which is to be carried out in October-November.

Trashing (removal of old and dried shoots, leaves and dried panicles) should be taken up once in a year during June-July, with the commencement of monsoon. This will help to prevent the spread of diseases and expose the panicles to easy visit by honeybees.

Soil conservation measures, maintenance of drainage channels and such other operations may be taken up promptly.

#### Manuring

Application of organic manures such as FYM, cowdung or compost @ 5 kg / plant or neem cake @ 1-2 kg / plant may be done during June-July. The present recommendation of nutrients for cardamom in Kerala under rainfed situation is N:P<sub>2</sub>O<sub>5</sub>:K<sub>2</sub>O @ 75:75:150 kg ha<sup>-1</sup>. The fertilizers may be applied in two split doses, before and after the southwest monsoon, in a circular band of 20 cm wide and 30-40 cm away from the base of the clumps and mixed with soil.

#### Shade

Since inadequate as well as excessive levels of shade are harmful to the crop, regulation of shade is inevitable. There should be sufficient shade to protect cardamom plant during the hot season. By regulating the shade before the monsoon, more light becomes available to the plant during the rainy season. Red cedar or chandana-vempu (*Toona ciliata*) is an ideal shade tree. It sheds the leaves during rainy season and thus provides natural shade regulation. Some of the other ideal shade trees are kurangatti

(*Acrocarpus fraxinifolius*), vellakil (*Dysoxylum malabaricum*) and thelli (*Canarium strictum*).

#### Bee-keeping for better pollination

The main pollination agent in cardamom is honeybee (*Apis cerana indica*). Maintaining four bee colonies per hectare during the flowering season is recommended for increasing fruit set and production of capsules.

#### Harvesting and processing

Cardamom plants normally start bearing capsules from the second year of planting. Picking is carried out at an interval of 45 days. After harvest, cardamom capsules are processed.

Cardamom capsules with green colour fetch a premium price in foreign countries. Hence emphasis has to be given on the preservation of green colour during curing and subsequent storage. Capsule should be processed within 24-36 hours after harvest to prevent colour deterioration. By curing, the moisture of green cardamom is reduced to 11 per cent at an optimum temperature so as to retain its green colour to the maximum extent.

Harvesting is done almost round the year in Kerala with the peak period from August - October.

#### Artificial drying

Processing of capsules is done in specially built curing houses. The harvested capsules are washed in water to remove dust and soil particles. Then they are spread on wire net trays in curing chamber. Burning firewood in the iron kiln produces heat required for drying. The heat thus produced is passed through pipes made of galvanized iron sheets. The process of drying takes about 18-24 hours, depending on the ambient temperature. The

capsules are spread thinly in the wire net trays and stirred frequently to ensure uniform drying. They are initially heated at 50°C for the first 4 hours and heat is then reduced to 45°C by opening ventilators and operating exhaust fans till the capsules are properly dried. Finally the temperature is raised to 60°C for an hour.

The dried capsules are rubbed on wire mesh to remove the stalk and dried portion of flower from the capsules and then graded according to size by passing through sieves of sizes of 7, 6.5, 6 mm etc. The graded produce is stored in polythene lined gunny bags to retain the green colour during storage and also to avoid exposure to moisture.

A relatively new innovation in the curing procedure is blanching by soaking the fruits in 2.0 per cent washing soda for 10 minutes prior to drying. This inhibits colour loss during drying operation and extends colour retention during subsequent storage from three months to ten months.

#### Sun drying

Capsules are dried directly under sunlight for five to six days or more. Frequent turning is done. This method can result in surface blemishes and may not give an attractive green colour. This method is practiced if the cultivar yields fruits that turn yellow before they are ready for picking and where facilities for green curing are not available.

#### Bleaching

A proportion of the crop is bleached after sun drying by exposing the capsules to fumes from burning sulphur to get uniform colour and appearance. Steeping capsules in a dilute solution of potassium metabisulphite solution induces a slight improvement in keeping quality.



### Oleoresin

Solvent extraction of ground spice yields 10 per cent oleoresin. Cardamom oleoresin dispersed in salt, flour etc., is used for flavouring food. One kilogram of oleoresin replaces 20 kg ground spice.

### Decorticated seeds / seed powder

Decorticated seeds command a lower price due to rapid loss of volatile oil during storage and transportation. Seed powder is marketed to a limited extent.

### Control of pests and diseases in the plantation

#### Cardamom thrips (*Sciothrips cardamomi*)

This insect is a serious pest of cardamom. It colonizes and breeds in unopened leaves, leaf sheath, flower bracts and flower tubes. It lacerates and feeds on the exuding sap from the aerial parts. Infestation on the panicle and flower buds results in stunted growth of panicles, shedding of flower buds and warty growth on the surviving capsules. The infested capsules are light in weight, inferior in quality and fetch very low price in the market. Since the pest population is high during dry months from December to May, pesticide application during this period is important. Four sprayings of insecticide during this period is recommended. Insecticide application can be skipped during rainy months of June and July. Three more sprayings are to be given during the period from August-November. Any of the following insecticides are recommended for thrips control.

Quinalphos 0.05 per cent, phosalone 0.07 per cent, dimethoate 0.05 per cent.

#### Shoot/capsule borer (*Conogethes punctiferalis*)

It is a serious problem to cardamom growers of Kerala, Tamil Nadu and Karnataka.

At the early stage of the crop, the caterpillars of this yellow coloured moth bore into the core of the aerial stem resulting in the death of central spindle, which appears as characteristic dead hearts.

At the time of flowering, when the caterpillars attack the panicles and spikes it may lead to flower shedding and drying up of the attacked portions. At a later stage of the crop, the caterpillars bore into the capsules, feed on the seeds and make them hollow. The presence of excreta at the region of attack indicates presence of the caterpillars in the pseudostem, inflorescence and pods.

Pest infestation is pronounced in three seasons viz. January-February, June and September-October.

#### Management

Later stages of larvae bore into the pseudostem and remain there. Insecticides sprayed at this time may not give adequate control of the pest. For an effective management of the pest, the insecticides have to be targeted on early stages of the larvae, which are usually present within 15-20 days after adult emergence in the field. Chemicals like Quinalphos and dimethoate @ 0.05% are recommended.

#### Leaf eating caterpillars

There are 10 species of caterpillars feeding on cardamom leaves. Out of these, seven species are hairy and appear in large numbers during certain seasons causing extensive defoliation. For controlling the leaf caterpillars, mechanical collection and destruction and spraying of any contact insecticide are recommended.

### Cardamom whitefly [*Kanakarajiella* (*Dialeurodes*) *cardamomi*]

It is a serious pest in cardamom growing tracts of Kerala. The adult is a small soft bodied insect, about 2 mm long and having two pairs of white wings. The nymphs are elliptical and pale green. The nymphs secrete sticky honeydew, which drops on to lower leaves. On these, black sooty mould develops, which interrupts photosynthesis of the leaves.

#### Management

The flies are attracted towards yellow colour. So metal sheets painted yellow and coated with sticky materials, such as castor oil or poly-venyl butanol would serve as traps. By placing such yellow sticky traps between rows of cardamom plants, population of adults can be monitored and adults trapped to some extent. Nymphs are effectively controlled by spraying the lower surface of leaves with a mixture of neem oil (500 ml) and triton (500 ml) in 100 litres of water. Acephate 0.1 per cent is effective. The spray may be repeated two or three times at 15 days interval.

### Cardamom root grubs (*Basilepta fulvicorne*)

The grubs of a small, greenish blue beetle cause damage. The grubs are short, stout, pale white in colour and often assume a shape resembling 'C', which feeds on cardamom roots. The symptoms start as yellowing of leaves, which later result in the drying up and death of the plant.

#### Management

Collect the beetle with hand nets or sticky traps at the time of mass emergence (March-April and August-September) and destroy. Early stages of the grub which are usually present in soil during May-June and

September-October can be controlled by drenching chlorpyrifos 0.04 per cent @ 3-4 litre per clump 10-15 cm around the plant.

### Cardamom scale (*Aulacaspis* sp.)

This scale insect is found on the lower surface of leaves, leaf sheath, panicles and fruit stalk. As a result of damage, capsules get shrivelled, panicles become dry and the leaves become yellow. The pest is mostly seen during summer months.

### Nematodes (*Meloidogyne* sp.)

Root knot nematodes are the most common nematode species associated with cardamom plantations. Common symptoms are necrosis of leaf tips and margins, narrowing of leaves, thickening of veins, reduction of internodal length and rosetting. Roots branch heavily and galls appear on them. Plant becomes highly stunted.

#### Management

Frequent change of nursery beds will help to reduce nematode infestation in nurseries.

Application of cartap hydrochloride 4G @ 1 kg ai/ha before monsoon and use of Neem cake 2 kg/plant before monsoon or *Bacillus macerans* ( $1 \times 10^7$  cfu) 30 g/plant or *Pseudomonas fluorescens* ( $1 \times 10^8$  cfu) 30 g/plant before monsoon.

### Diseases

#### Katte or mosaic

This is a virus disease, which is transmitted by the banana aphid, *Pentalonia nigro-nervosa*. The symptoms consist of discontinuous stripes of light green colour running almost parallel to each other from the mid-rib to the margin of the leaves, which form a mosaic pattern. On young shoots, such stripes are seen on the leaf sheath also. The infected clumps will be smaller in size with fewer tillers.

### Management

Eradication of the source of inoculum by destroying infected plants and destruction of the vector by insecticide application are effective. Regular application of insecticide against cardamom thrips controls the aphids also. Avoid using katte-infected rhizome for planting.

Destruction of plants showing symptoms of the disease should be done promptly once in two months. Removal of all alternate hosts of virus is also recommended.

### Azhukal

This is a fungal disease caused by *Phytophthora* sp. occurring during the rainy season. It affects the leaves, tender shoots, panicles and capsules. On the infected leaves, water soaked lesions appear first and rotting and shedding of leaves along the veins occur thereafter. The infected capsules become dull greenish brown and decay. This emits a foul smell and subsequently shed. Infection spreads to the panicles also.

### Management

Trashing and destruction of the infected parts should be done as a phytosanitary measure just prior to the onset of southwest monsoon. Remove the trash (dried leaves and leaf sheaths) from the basal region of the plant to the extent possible.

Spray the shoots with 1 per cent Bordeaux mixture with adhesive (rosin soda or any other sticker) by the commencement of the monsoon and continue the spraying operation two or three times up to November-December according to the intensity of the disease and rainfall. Give spray to the panicle with 1 per cent Bordeaux mixture during July-August when the disease intensity is maximum.

Drench with 0.1% Fosetyl -Al (3-5 l/plant) and repeat this at monthly interval depending the intensity of the disease and rainfall.

Prophylactic application of the biocontrol agent *Pseudomonas fluorescens* (two percent spray) along with basal application of Mycorrhiza (100 g) and *Trichoderma viride* (50 g) per plant by the commencement of the monsoon and continue the spraying operation monthly depending on the intensity of the disease and rainfall. *Trichoderma* can be used along with cowdung for controlling this disease.

### Clump rot or rhizome rot

This disease is caused by *Pythium aphanidermatum*, *P. vexans*, *Rhizoctonia solani* and *Fusarium oxysporum*. The affected shoots become brittle and easily break off from the rhizome at the bulbous base.

### Management

Drench with 2 g l<sup>-1</sup> copper oxychloride (2-3 l plant<sup>-1</sup>) and repeat this two times at monthly intervals.

As a bio-control measure, inoculate suckers with native arbuscular mycorrhiza, *Trichoderma* and *Pseudomonas fluorescens* at the time of planting and apply during pre-monsoon period in established plantations (see the chapter on biocontrol agents against plant pathogens).

### Stem rot or stem lodging

This disease is caused by a fungus (*Fusarium oxysporum*). The pathogen attach middle portion of a tillers as a result, the infected one produces pale colour lesions leading to dry rotting. The disease occurs during non rainy seasons.

### Management

The affected tillers must be removed and

destroyed. Spraying Carbendazim @ 0.1 per cent checks the disease spread. Application of Trichoderma @ 10 g per clump<sup>1</sup> along with 0.5 kg quality neem cake is recommended as preventive measure.

#### Leaf blotch disease

The fungus *Phaeodactylium venkatesanum* causes this disease. The disease is characterized by the appearance of large blotches of irregular lesions with alternating shades of light and dark brown necrotic tissues. This is mainly observed on mature leaves. On the lower surface of the lesions ash coloured white superficial growth of the fungus appears during moist weather conditions.

#### Management

The fungicides, Bordeaux mixture (1 per cent), mancozeb (3 g l<sup>-1</sup>) and carbendazim (1 g l<sup>-1</sup>) are effective in controlling the disease.

#### Chenthal disease

Chenthal disease is characterized by the appearance of rectangular linear reddish brown lesions mainly on the lower surface of the leaves. The lesions are clearly visible even on dried leaves. The incidence of the disease appears to be more severe in areas, which do not have proper shade. Even though *Corynebacterium* and *Colletotrichum gloeosporioides* have been isolated from the infected leaves, the pathogenicity of these organisms could not be established.

#### Management

Providing adequate shade is the only measure recommended pending confirmation of etiology of the disease.

Waiting period of insecticide / fungicide

Quinalphos	30 days
Mancozeb	30 days

## CINNAMON (*Cinnamomum zeylanicum*)

Cinnamon grows in areas up to an altitude of about 1800 m. Humid tropical evergreen rain forest conditions favour the best growth of cinnamon. Well-drained, deep sandy soil, rich in humus is suitable for the crop. Avoid marshy areas and hard laterites.

#### Varieties

Navasree, Nithyasree and Sugandini.

#### Seeds and sowing

Cinnamon is usually propagated through seeds. Sow seeds immediately after harvest on raised beds. Pot seedlings when they are six months old.

#### Vegetative propagation

For raising cinnamon from cuttings; semi hardwood cuttings of about 10 cm length with 2 leaves are taken and dipped in IBA 2000 ppm and planted either in polythene bags filled with sand or a mixture of sand and coir dust in the ratio 1:1 or in sand beds raised in a shaded place. The cuttings in polythene bags must also be kept in a shaded place or in a nursery. The cuttings are to be watered regularly 2-3 times a day for maintaining adequate moisture and prevent wilting. Rooting takes place in 45-60 days. The well rooted cuttings can be transplanted to polythene bags filled with potting mixture and maintained in a shaded place and watered regularly.

### Air Layering

Air layering is recommended for all cinnamon nurseries. It is done on semi hardwood shoots. A ring of bark is removed from the semi hardwood portion of the shoot and a rooting hormone (IBA 2000 ppm or IAA 2000 ppm) is applied on the portion where the bark has been removed. Moist coir dust or coir husk is placed around the region where the hormone has been applied and is secured in position by wrapping with a polythene sheet of 20 cm length. This would also avoid moisture loss. Rooting takes place in 40-60 days. The well rooted air layers are separated from the mother plant and bagged in polythene bags filled with potting mixture and kept in a shaded place or nursery by watering the plants twice daily.

### Planting

Select seedlings with green leaf petioles. Plant seedlings in the main field when they are 1-2 years old with the commencement of southwest monsoon. Planting is done in pits of size 60 cm x 60 cm at a spacing of 2 m x 2 m. Dig the pits sufficiently early to allow weathering. Fill the pit with leaf mould and topsoil before planting.

### Manuring

Apply  $N:P_2O_5:K_2O$  @ 20:20:25 g per seedling in the first year and double this dose in the second year. Cattle manure or compost at 20 kg per plant per annum may also be applied. Increase the dose of  $N:P_2O_5:K_2O$  gradually to 200:180:200 g per tree per year for grown up plants of 10 years and above.

Apply organic manures in May-June and fertilizers in two equal split doses, in May-June and September-October.

### After cultivation

Weed regularly in the early stages of growth. Irrigate the seedlings till they get

established, if there is long drought period. Prune plants when they are 2-3 years old at a height of 15 cm above ground level. Cut the side shoots growing from the base to encourage growth of more side shoots till the whole plant assumes the shape of a low bush.

### Harvesting and curing

The plants will be ready for harvest in about 3 years after planting. Harvesting is done during two seasons, the first in May and second in November. The correct time for cutting the shoots for peeling is determined by noting the sap circulation between the wood and corky layer. Peelers can judge this by making a test cut on the stem with a sharp knife. If the bark separates readily, the cutting is taken immediately. Stems measuring 2.0 to 2.5 cm in diameter and 1.5 to 2.0 m length are cut early in the morning and twigs and leaves are detached. The outer brown skin is first scrapped off and the stem is rubbed briskly to loosen the bark. Two cuts are made round the stem about 30 cm apart and two longitudinal slits are made on opposite sides of the stem. The bark is separated from the wood with curved knife. The detached pieces of bark are made into compound quills. The best and longest quills are used on the outside while inside is filled with smaller pieces. The compound quills are rolled by hand to press the outside edges together and are neatly trimmed. They are dried in shade as direct exposure to sun can result in warping. The dried quills consist of mixture of coarse and fine types and are yellowish brown in colour.

The quills are graded as Fine or Continental, Mexican and Hamburg or Ordinary. The Fine consists of quills of uniform thickness, colour and quality and the joints of the quills are neat. Mexican grades are intermediate in quality. The Hamburg grade consists of thicker and darker quills. The lower grades are exported as:  
(a) Quillings: The broken lengths and

fragments of quills of all grades are bulked and sold as quillings; (b) Featherings: This grade consists of the inner bark of twigs and twisted shoots that do not give straight quills of normal length.

Chips: This includes the trimmings of the cut shoots, shavings of outer and inner bark, which cannot be separated, or which are obtained from small twigs and odd pieces of thick outer bark.

#### Oleoresin

Cinnamon oleoresin is prepared by extracting cinnamon bark with organic solvent. Oleoresin yield varies from 10 to 12 per cent. The oleoresin is dispersed on sugar, salt and used for flavouring processed foods.

#### Cinnamon bark oil

A pale yellow liquid possessing the delicate aroma of the spice is obtained by steam distillation of quills (0.2 to 0.5 per cent). Its major component is cinnamaldehyde (55 per cent) but other components like eugenol, eugenyl acetate, ketones, esters and terpenes also impart the characteristic odour and flavour to this oil. Cinnamon bark oil is used in flavouring bakery foods, sauces, pickles, confectionery, soft drinks, dental and pharmaceutical preparations and also in perfumery.

#### Cinnamon leaf oil

Cinnamon leaf oil is produced by steam distillation of leaves yielding 0.5 to 0.7 per cent

oil. It is yellow to brownish yellow in colour and possesses a warm, spicy but rather harsh odour. The major constituent is eugenol (70 to 90 per cent) while the cinnamaldehyde content is less than five per cent. The oil is used in perfumery and flavouring and also as a source of eugenol.

#### Cinnamon root bark oil

The root bark contains 1.0 to 2.8 per cent oil containing camphor as the main constituent. Cinnamaldehyde as well as traces of eugenol are found in the oil, having less commercial relevance.

#### Plant protection

##### Leaf spot and dieback disease (*Colletotrichum gloeosporioides*)

On young nursery seedlings, small brown specks appear which gradually enlarge resulting in drying of the leaf. From the leaves, the infection spreads to the stem, resulting in necrosis from the apex downwards.

On old seedlings and mature trees, light and dark brown concentric zonation occurs. Spraying 1 per cent Bordeaux mixture during rainy season controls the disease.

The other diseases of cinnamon include grey blight caused by *Pestalotiopsis palmarum*, sooty mould caused by *Phragmocapnium* sp. and algal leaf spot by *Cephaleuros* sp.

## CLOVE (*Syzygium aromaticum*)

Clove requires a warm humid tropical climate with an annual rainfall from 150-250 cm. It grows well from mean sea level up to an altitude of 800-900 m. Deep loam soils with high humus content and black loams of semi-forest regions with good drainage are

suited for the cultivation of the crop.

#### Selection of site

Select partially shaded sites having adequate protection from high winds. Avoid exposed and shady locations.

### Seeds and sowing

Clove is propagated through seeds obtained from fully developed fruits known as mother of clove. Collect fully developed fruits from high yielding mother trees. Dehusk the fruits immediately after collection by soaking in water and peeling. Prepare raised nursery beds with fertile soil rich in humus under the shade of trees. Sow the seeds flat at a depth 2-5 cm and a spacing of 12-15 cm. Water the beds regularly. Seedlings can either be retained in the nursery till they attain a height of 25-30 cm when they are ready for transplanting or potted when they are six months old and transplanted after another 12-18 months.

### Planting

Select 18 months old seedlings for planting. Prepare pits of size 60 cm x 60 cm x 60 cm at a spacing of 6 m x 6 m about a month in advance of planting. Allow to weather. Fill up the pits with mixture of burnt earth, compost and topsoil. Plant the seedlings during the rainy season, May-June or August-September. Provide shade and irrigation during breaks in the monsoon and summer. Banana or glyricidia may be planted to provide shade.

Clove is generally grown as a mixed crop with coffee, coconut, arecanut etc.

### Manuring

Apply cattle manure or compost at the rate of 15 kg per tree per annum during May-June. The recommended fertilizer dose is N:P<sub>2</sub>O<sub>5</sub>: K<sub>2</sub>O @ 20:18:50 g per plant during the first year and @ 40:36:100 g per plant during the second year. Increase gradually the dose to 300:250:750 g per plant per year for a well grown tree of 15 years or more. Apply organic manures in May-June with the commencement of southwest monsoon. Apply fertilizers in two equal split doses in May-June along with the organic manures and in

September-October in shallow trenches dug around the plant about 1 to 1.25 m away from the base.

### After cultivation

Conduct weeding and intercultivation whenever necessary. Cut and remove dead and diseased branches of fully grown trees to prevent over crowding. Spray one per cent Bordeaux mixture to control dieback.

### Harvesting and curing

The trees begin to yield from 7-8 years after planting. The stage of harvest of flower buds determine the quality of the final dried product. Buds are harvested when the base of calyx has turned from green to pink in colour. If allowed to develop beyond this stage, the buds open, petals drop and an inferior quality spice is obtained on drying.

Prior to drying, buds are removed from the stem by holding the cluster in one hand and pressing it against the palm of the other with a slight twisting movement. The clove buds and stems are piled separately or drying. Buds may be sorted to remove over ripe cloves and fallen flowers. Drying should be done immediately after the buds are separated from the clusters. If left too long in heaps, they ferment and the dried spice has a whitish shriveled appearance (khoker clove).

The traditional method of drying is by exposing them to sun in mats. The green buds are spread out in a thin layer on the drying floor and are raked from time to time to ensure the development of a uniform colour and to prevent mould formation. In sunny weather, drying is completed in 4-5 days giving a bright coloured dried spice of attractive appearance. During drying, clove loses about two-third of its original fresh green weight. When properly dried, it will turn bright brown and does not bend when pressed. The

dried cloves are sorted to remove mother of cloves and khoker cloves, bagged and stored in a dry place. The stem after separation of buds is dried in a similar manner as the spice, without allowing mould formation and fermentation.

#### Clove bud oil

The essential oil is obtained by steam distillation of comminuted buds or whole cloves. On distillation, about 17 per cent essential oil is obtained which is a colourless or yellow liquid possessing odour and flavour characteristic of the spice. Finest oil contains 85-89 per cent eugenol. Clove bud oil is used for flavouring food and in perfumery.

#### Clove stem oil

Clove stem oil is obtained from dried peduncles and stem of clove buds (5-7 per cent) on steam distillation. The eugenol content of the oil ranges from 90-95 per cent. This oil possesses a coarser and woodier odour than bud oil.

#### Clove leaf oil

Clove leaves on distillation yield 2-3 per cent oil as a dark brown liquid with a harsh woody odour. When rectified, it turns pale yellow and smells sweeter with a eugenol content of 80 to 85 per cent.

#### Oleoresin

Clove oleoresin may be prepared by cold or hot extraction of crushed spices using organic solvents like acetone giving a recovery of 18-22 per cent. The oleoresin is chiefly used in perfumery and when used for flavouring it is dispersed on salt, flour etc.

#### Plant protection

##### Pests

Infestation of shoot borer *Sinoxylon* sp. can be controlled by pruning off the laterals of old

trees showing dieback symptoms. Do not allow dried glyricidia and other twigs to remain in the plantation, to ensure that the beetles will not multiply on these materials and subsequently initiate infestation in cloves.

#### Diseases

Leaf spot, twig blight and flower bud shedding (*Colletotrichum gloeosporioides*)

Three types of symptoms are seen viz., leaf spot, twig blight and flower bud shedding. On the leaves, necrotic spots of variable sizes and shapes are noticed. Severely affected leaves wither, drop and dry up. In the nursery seedlings, dieback symptoms are seen. Extension of the symptoms from the leaves through petioles results in the infection of twigs. The affected branches stand without leaves or only with young leaves at the tips. The flower buds are attacked by spread of infection from the twigs. Shedding of flower buds occur during periods of heavy and continuous rainfall.

#### Management

Spraying 1 per cent Bordeaux mixture at 1-1.5 month intervals reduces disease intensity, defoliation and flower bud shedding. The spraying has to be commenced just prior to flower bud formation and continued till the harvest of flower buds for effective control. Destruction of the weed *Clerodendron* from the clove garden is recommended to reduce the disease since the pathogen survives on this weed during adverse conditions.

The other diseases of clove are: Grey blight of clove (*Pestalotia palmarum*), Leaf spot of clove (*Cylindrocladium quinqueseptatum*), Leaf spot of clove (*Alternaria citri*), Sooty mould of clove (*Phragmocapnius* sp.), Algal leaf spot of clove (*Cephaleuros* sp.).



## VANILLA (*Vanilla planifolia*)

Vanilla is a tropical orchid requiring a warm climate with frequent rains, preferring an annual rainfall of 150-300 cm. Uncleared jungle areas are ideal for establishing vanilla plantations. In such locations, it would be necessary to retain the natural shade provided by lofty trees and to leave the soil or the rich humus layer on the top undisturbed. Vanilla is cultivated on varied type of soils from sandy loam to laterites. It requires filtered sunlight. In the absence of natural shade, trees should be grown to provide shade.

### Preparation of land

Clear the land of jungle growth and prepare for planting. Being a creeper, the plant requires support up to a height of about 130-135 cm. Cuttings of *Plumaria alba*, *Erythrina lithosperma*, *Jatropha carcas* and *Glyricidia maculata* are suitable as live supports. The growth of live standard is to be adjusted to make them branch at a height of 120-150 cm to facilitate trailing of the vines and artificial hand pollination.

### Time and method of planting

Vanilla is propagated by planting shoot cuttings in situ. Plant cuttings of 60 cm length. Longer cuttings bear earlier than shorter cuttings. Rooted cuttings as well as tissue culture derived plants can also be used for planting.

Plant the cutting with the onset of monsoon rains. Set out the cutting at a spacing of 2.7 m between plants and 1.8 m between rows in pits of size 40 cm x 40 cm x 40 cm. Trail the vines on the live supports and when they attain a height of 135 cm trail them horizontally on bamboo poles tied to vertical supports or branches of support plants

in loops touching the ground.

### Manuring

Being a surface rooting plant, manuring should be confined to the surface layer of soil. Provide heavy and frequent mulching to the vines. Apply 120 g of N in the form of leaf mould or FYM in two split doses in June-July and September-October.

### After cultivation

Vanilla cannot withstand even the slightest root disturbance. Hence remove weeds from the plant base by hand weeding and use them as mulch.

Being closely planted, no intercrops are raised in a pure plantation of vanilla. But vanilla can be planted as an intercrop in coffee, coconut, arecanut etc.

### Pollination, harvesting and curing

Flowering of vine commences usually by about the third year. The inflorescence is produced in the leaf axils. There is a tendency for some of the vines to maintain only vegetative growth. A light nipping off or pruning of the terminal shoots hastens flowering. Due to the peculiar structure of the flowers, self-pollination is not possible. Hence hand pollination is adopted for fruit set. Best time for pollinating the flowers is between 6 am and 1 pm and a success of 80-85 per cent can be obtained. Successful fertilization is indicated by the retention of calyx and the stigma even after four days of pollination.

The pods ripen in about 9-11 months time. Before attaining maturity the fruit is dark green in colour and when ripe yellowing commences from the tip of the pod. Collect the pods at this time, as this is the optimum time for harvesting the pod. If allowed to remain on the vine further,

the pods split. Free vanillin is not present in the beans when they are harvested. Beans do not have the aroma at this stage. Vanillin is developed as a result of enzyme action on a glycoside during the process of curing of beans.

Curing of vanilla involves immersing the beans (2-3 days after harvest) in hot water at a temperature of 63 to 65°C for three minutes for the cessation of vegetative life. After a rapid drying on woolen blankets, when the beans are still very hot, they are kept in chests lined with blankets. Next day they are spread out in sun on blanket for three to four hours and rolled up to retain the heat. Repeat this for six to eight days during which beans lose their weight, become supple and can be twisted on finger without breaking. This is followed by slow drying in the shade for a period of two to three months. Properly dried beans are kept in trunks where the fragrance is fully developed. Finally, they are graded according to size and bundled and placed in iron boxes lined with paraffin paper. The

vanillin content of properly cured beans will be about 2.5 per cent.

#### Plant protection

The occurrence of a wilt disease caused by *Fusarium oxysporum* has been observed. For control of wilt disease adopt the following measures.

1. Remove diseased plants along with surrounding soil where the disease is observed.
2. Remove weeds around the plants.
3. Mulch the base of the vine with dry leaves before and after monsoon.
4. Avoid injury to roots during cultivation.
5. Drench soil around the base of vine with 1 per cent Bordeaux mixture.

Fungal diseases like shoot tip rot, stem and bean rot caused by *Phytophthora* sp. as well as immature bean drop are noticed. The disease affected portions are to be removed regularly and 1 per cent Bordeaux mixture should be applied on the affected plants.

## GINGER (*Zingiber officinale*)

Ginger is a tropical plant adapted for cultivation even in regions of subtropical climate such as the high ranges. It prefers a rich soil with high humus content. Being an exhausting crop, ginger is not cultivated continuously in the same field but shifting cultivation is practised. The crop cannot withstand waterlogging and hence soils with good drainage are preferred for its cultivation. It is shade tolerant / loving crop with shallow roots and therefore suitable for intercropping and as a component in the homesteads where low to medium shade is available.

#### Preparation of land

Clear the field during February-March and burn the weeds, stubbles, roots etc. in situ. Prepare the land by ploughing or digging. Prepare beds of convenient length (across the slope where the land is undulating), 1 m width, 25 cm height with 40 cm spacing between the beds. Provide drainage channels, one for every 25 beds on flat lands.

#### Varieties

Improved varieties: Athira, Karthika, Aswathy, IISR-Varada, IISR-Rejatha and IISR-Mahima.

Dry ginger Cultivars: Maran, Wayanad, Manantoddy, Himachal, Valluvanad, Kuruppampady.

Green ginger cultivars / varieties : Rio-De-Janeiro, China, Wayanad Local and Aswathy.

Dual purpose varieties: Athira, Karthika, IISR-Varada, IISR-Rejatha and IISR-Mahima.

#### Planting material

Ginger rhizomes are used for planting. For selection and preservation of seeds, adopt the following methods:

Mark healthy and disease free plants in the field when the crop is 6-8 months old and still green. Select best rhizomes free from pest and disease from the marked plants. Handle seed rhizomes carefully to avoid damage to buds. Soak the selected rhizomes for 30 minutes in a solution of mancozeb and malathion to give terminal concentration of 0.3 per cent for the former and 0.1 per cent for the latter. Dry the treated rhizomes in shade by spreading on the floor. Store the treated rhizomes in pits dug under shade, the floor of which is lined with sand or saw dust. It is advisable to spread layers of leaves of *Glycosmis pentaphylla* (panal). Cover the pits with coconut fronds.

Examine the stored rhizomes at monthly intervals and remove the rhizomes that show signs of rotting. This will help to keep the inoculum level low. Provide one or two holes for better aeration. Treat the seed rhizomes similarly before planting also.

Single bud sprout transplanting: A transplanting technique using single bud sprouts (about 5g) has been standardized to produce good quality planting material with reduced cost.

The process include

- Selection of healthy rhizomes of high yielding varieties of ginger.
- Treating the seed rhizome with mancozeb (0.3 %) and quinalphos (0.075%) for 30 min. before storage.
- Preparation of single bud sprouts (4-6 g) by cutting ginger rhizomes and
- Treatment of single bud sprouts with mancozeb 0.3%, for 30 minutes before planting after 30 days.

For raising sprouts, 98 well pro-trays and nursery medium of partially decomposed coir pith and vermicompost in the ratio of 3:1 are recommended. The advantages are less planting material requirement, 500-750 kg per ha, 98-100 per cent field establishment, high cost: benefit ratio and suitability for early/delayed planting and high production technology.

#### Season and method of planting

The best time for planting ginger is during the first fortnight of April, after receipt of pre-monsoon showers. For irrigated ginger, the best suited time for planting is middle of February (for vegetable ginger).

Plant rhizome bits of 15 g weight in small pits at a spacing of 20 cm x 20 cm to 25 cm x 25 cm and at a depth of 4-5 cm with at least one viable healthy bud facing upwards.

Seed rate 1500 kg ha<sup>-1</sup>

#### Manuring

Apply 20 t FYM + 2 t Neem cake + 1 t Ash + 4 t vermicompost/ha. Also use *Azospirillum* and *P-Solubilising bacteria* (20 g/bed of 3 x 1 m) as nutrient supplement.

Drench the beds with PGPR GRB 35 (*Bacillus amyloliquifaciens*) for growth promotion and suppression of soft rot disease.

Apply manures and fertilizers at the following rates:

FYM	30 t ha <sup>-1</sup>
N:P <sub>2</sub> O <sub>5</sub> :K <sub>2</sub> O	75:50:50: kg/ha/year

Full dose of P<sub>2</sub>O<sub>5</sub> and 50 per cent of K<sub>2</sub>O may be applied as basal. Half the quantity of N may be applied 60 days after planting. The remaining quantity of N and K<sub>2</sub>O may be applied 120 days after planting.

#### Mulching

Immediately after planting, mulch the beds thickly with green leaves @ 15 t ha<sup>-1</sup>. Repeat mulching with green leaves twice @ 7.5 t ha<sup>-1</sup> first 44-60 days and second 90-120 days after planting. Grow green manure crops like daincha and sun hemp in the interspaces of beds, along with ginger and harvest the green manure crop during second mulching of ginger beds.

Application of dried coconut leaves as mulch in ginger beds after removing the petiole at the time of planting is also recommended. Dried coconut leaves after removing the petiole, split into two at midrib @ 8 kg/ 3x1 m/ bed or 5400 kg ha<sup>-1</sup> for effective weed control in ginger. Subsequent application of green leaf at 45 & 90 DAP is not required. This environment friendly technology recorded 87% weed control efficiency, less incidence of soft rot incidence (8.7%) with a B:C ratio 1.97 compared to unweeded control with no mulching.

#### After cultivation

Remove weeds by hand weeding before each mulching. Repeat weeding according to weed growth during the fifth and sixth month

after planting. Earth up the crop during the first mulching and avoid water stagnation.

#### Plant protection

For managing shoot borer following measures are recommended

1. Spray *Beauveria bassiana* @ 5 X 10<sup>8</sup> conidia/ml and Chlorantraniliprole 18.5% SC at 0.005 per cent.
2. Spray dimethoate or quinalphos at 0.05 per cent.
3. Spray neem oil (5 ml l<sup>-1</sup> of water) in combination with the cultural control recommended for shoot borer.

For the management of rhizome rot, bacterial wilt and fusarium yellows of ginger the following practices are recommended:

- BO  
DH Soil application of Bleaching powder (15g) + lime (250g 3m<sup>2</sup>) - ATP, 2MAP, 4 MAP
  - BO  
DH Rhizome treatment with mancozeb (3 g l<sup>-1</sup>) for 30 min. + Soil application of bleaching powder (15 g) + lime (250 g 3 m<sup>2</sup> bed) -2 MAP & 4 MAP
  - BO  
DH Seed treatment/Soil application of *Pseudomonas fluorescens* (2%) + cowdung supernatant (2%)-ATP, 2MAP, 4MAP
  - BO  
DH PGPM - Seed treatment/soil application - ATP, 2MAP, 4MAP
4. Adopt the following to control Rhizome rot and Fusarium yellow.
    - a. Select sites having proper drainage.
    - b. Select seed rhizomes from disease free areas.
    - c. Treat seed rhizomes with 0.3 per cent mancozeb.
    - d. When incidence of rhizome rot is noted in the field, dig out the affected plants

and drench the beds with cheshunt compound or 1.0 per cent Bordeaux mixture or 0.3 per cent mancozeb.

- e. Inoculation with native arbuscular mycorrhiza, *Trichoderma* and *Pseudomonas fluorescens* at the time of planting is recommended as a biocontrol measure.
5. For controlling the leaf spot disease, 1 per cent Bordeaux mixture, 0.3 per cent mancozeb or 0.2 per cent thiram may be sprayed.
6. For control of nematode in endemic area, apply neem cake @ 1.0 t ha<sup>-1</sup> at planting followed by application of neem cake @ 1.0 t ha<sup>-1</sup> at 45 days after planting (DAP).

#### Harvesting and processing

For vegetable ginger, the crop can be harvested from sixth month onwards. For dry ginger, harvest the crop between 245-260 days. After harvest, the fibrous roots attached to the rhizomes are trimmed off and soil is removed by washing. Rhizomes are soaked in water

overnight and then cleaned. The skin is removed by scrapping with sharp bamboo splits or such other materials. Never use metallic substances since they will discolour the rhizomes. After scrapping, the rhizomes are sun dried for a week with frequent turnings. They are again rubbed well by hand to remove any outer skin.

#### Ginger oil

Ginger oil is prepared commercially by steam distillation of dried powdered ginger. The yield of oil varies from 1.3 to 3.0 per cent. The major use of ginger oil is as a flavouring agent for beverages, both alcoholic and non-alcoholic.

#### Ginger oleoresin

Oleoresin from ginger is obtained conventionally by extraction of dried powdered ginger with organic solvents like ethyl acetate, ethanol or acetone. Commercial dried ginger yields 3.5-10.0 per cent oleoresin. Ginger oleoresin is a dark brown viscous liquid responsible for the flavour and pungency of the spice.

## MANGO GINGER (*Curcuma amada*)

It is an under exploited spice crop, which grows luxuriantly in tropical soils with good drainage. The rhizomes of mango ginger are used for preparing pickles, chutney, preserve, candy, sauce and salad and in meat and other culinary preparations. The rhizome has excellent medicinal properties and finds extensive use in the indigenous system of medicine. It is, appetizer, antipyretic, aphrodisiac and laxative. It is useful in biliousness, itching, skin diseases, bronchitis, asthma, hiccough and inflammation due to injuries. The rhizomes and roots are

camminative and stomachic and in crushed pulp form they are applied over contusions, sprains and bruises for rapid healing.

Mango ginger is botanically related to neither mango nor ginger, but to turmeric (*Curcuma longa*). Morphologically mango ginger plant is similar to turmeric, but has shorter crop duration of six months. The rhizomes are pale yellow inside with lighter colour outside, have sweet smell of unripe mango when crushed. The crop comes up well in open conditions, but tolerates low levels of

shade and therefore partially shaded situations can also be utilized for its cultivation. It can be well accommodated as an intercrop in coconut gardens and in rotation with other short duration crops like vegetables and also as a crop component in homesteads.

#### Preparation of land

Prepare the land to a good tilth during February-March subject to the availability of pre-monsoon showers. Prepare beds of convenient length, 1.2 m width, 25 cm height and 40 cm spacing between beds.

#### Seed material and varieties

Whole or split mother rhizomes or well developed, healthy and disease free finger rhizomes weighing 15-20 g are suitable for planting. In Kerala, local varieties are used for cultivation. Amba is a released variety from High Altitude Research Station, Pottangi, Orissa.

#### Season and method of planting

Plant during April with the commencement of pre-monsoon showers. Take small pits in the beds with a spacing of 25 cm x 30 cm and at a depth of 4-5 cm. Adopt a seed rate of 1500 kg ha<sup>-1</sup>.

#### Manuring

Apply cattle manure or compost as basal

dose @ 30-40 t ha<sup>-1</sup>, spread over the beds and mix well. Apply N:P<sub>2</sub>O<sub>5</sub>:K<sub>2</sub>O fertilizer @ 30:30:60 kg ha<sup>-1</sup>. Full dose of P<sub>2</sub>O<sub>5</sub> and half dose of K<sub>2</sub>O may be applied as basal. Apply two-third dose of nitrogen 30 days after planting and remaining N and K<sub>2</sub>O at 60 days after planting.

#### Mulching

Mulch the crop immediately after planting with green leaves @ 15 t ha<sup>-1</sup>. Repeat mulching after 50 days with same quantity of green leaves.

#### After cultivation

The rhizomes germinate within 3-4 weeks. Remove weeds 45 days after planting and repeat if necessary. Earth up the crop after 60 days of planting.

#### Plant protection

Compared to the related crops ginger and turmeric, the crop is free from pests and diseases. But when large scale cultivation is taken up, the attack of shoot borer (*Conogethes punctiferalis*) causes damage to the crop. Appearance of dead heart in the field is the main symptom. To reduce the pest population, pull out the dead hearts with the larvae inside and burn it. If infestation is severe, spray dimethoate or quinalphos at 0.05 per cent.

## NUTMEG (*Myristica fragrans*)

Nutmeg requires a hot, humid climate without pronounced dry season. The soil should be rich in organic matter and well drained. The tree prefers partial shade. Sheltered valleys are the best suited. It can be grown up to about 900 m above MSL.

Variety: IISR-Viswashree

#### Seeds and sowing

Fully ripe tree-burst fruits are selected for

raising seedlings. The fleshy rind and the mace are removed before sowing. The seeds should be sown immediately after collection. If there is any delay in sowing, the seeds should be kept in baskets filled with damp soil. The seedbeds of 100-120 cm width, 15 cm height and of convenient length may be prepared in cool and shady places. A mixture of garden soil and sand in the ratio 3:1 may be used for preparing nursery beds. Over this, sand is

spread to a thickness of 2-3 cm and the seeds dibbled 2 cm below the surface at a spacing of about 12 cm on either side. Seeds germinate within 50-80 days after sowing. When the plumule produces two elongated opposite leaves, the seedlings are to be transferred from beds to polybags.

Vegetative propagation of nutmeg through epicotyl grafting is recommended for all nutmeg nurseries.

### Planting

Since the nutmeg trees require shade, suitable fast growing shade trees like Albizia, Erythrina etc. are planted in advance. Banana can also be grown as a shade crop in the early stages. Pits of 90 cm x 90 cm x 90 cm are dug at a spacing of 8 m x 8 m with the onset of southwest monsoon. The pits are filled with topsoil and compost or well decomposed cattle manure and seedlings are planted.

### Manuring

Apply 10 kg cattle manure or compost per seedling during the first year. Increase the quantity gradually till a well grown tree of 15 years and above receives 50 kg of organic manures per year. Apply N:P<sub>2</sub>O<sub>5</sub>:K<sub>2</sub>O @ 20:18:50 g/plant during the first year. This may be doubled in the next year. Gradually increase the N:P<sub>2</sub>O<sub>5</sub>:K<sub>2</sub>O dose to 500:250:1000 g/plant/year to obtain full dose from 15<sup>th</sup> year onwards.

### Harvesting

Fruits are available throughout the year, but the peak period of harvest is from June to July. When fruits are fully ripe, the nuts split open. These are either plucked from the tree or allowed to drop. The two major products are nutmeg and mace. Dried nutmeg and mace

are directly used as spice and also for the preparation of their derivatives.

After de-rindling the nutmeg fruit, red feathery aril (mace) is separated from pericarp. The mace is detached, flattened and sun dried on mats for 3-5 days or in artificial heat drier.

The nuts are sun dried for four to eight weeks or in artificial heat drier until kernel rattle inside the shell. They are stored in warm dry place prior to shelling.

### Oleoresin

Nutmeg and mace oleoresins are prepared by extracting the ground spice with organic solvents. Yield of oleoresin is 10-12 per cent for nutmeg and 10-13 per cent for mace. Mace oleoresin possesses a fine, fresh fruity character.

### Nutmeg butter

Nutmeg contains 25-40 per cent of fixed oil that can be obtained by pressing the crushed nuts between plates in the presence of steam or by extracting with solvents. The product, known as nutmeg butter, is a highly aromatic, orange coloured fat with the consistency of butter at ambient temperature.

### Nutmeg oil

This is obtained as pale yellow to white volatile liquid possessing a fresh warm aromatic odour. The yield ranges from 7 to 16 per cent. The unshelled nuts are coarsely crushed in a mechanical cracker and steam distilled.

### Mace oil

The mace yields 4-17 per cent colourless to pale yellow liquid possessing organoleptic properties similar to nutmeg oil. Nutmeg and mace oil are also used for flavouring.

### Pests

The hard scale *Saissetia nigra* occurs on the pencil thick branches and desaps the tissues. The infested shoots invariably develop sooty mould cover. It can be controlled by spot spraying with quinalphos 0.025 per cent.

### Diseases

#### Leaf spot and die back (*Colletotrichum gloeosporioides*)

Sunken spots surrounded by a yellow halo are the initial symptoms. Subsequently the central portion of the necrotic region drops off resulting in shot hole symptoms. Dieback symptoms are also observed in some of the mature branches. On young seedlings drying of the leaves and subsequent defoliation are seen. The disease can be

controlled by spraying 1 per cent Bordeaux mixture two or three times during rainy season.

#### Fruit rot

This is caused by *Colletotrichum gloeosporioides* and *Botryodiplodia theobromae*. Water soaked lesions are seen on the fruits, the tissues of which become discoloured and disintegrated. Premature splitting of the pericarp and rotting of mace and seed are the main symptoms of the disease. The internal tissues are found rotten. The fallen fruits become enveloped with the growth of the organism. The disease can be controlled by spraying 1 per cent Bordeaux mixture.

Other diseases: *Phytophthora* leaf fall, white thread blight, horse hair blight, sooty mould and algal leaf spot.

## BLACK PEPPER (*Piper nigrum*)

Pepper requires a warm and humid climate. Though an annual rainfall of 250 cm is ideal for the proper growth of the crop, it can also come up well in low rainfall areas, if the pattern and distribution of rainfall are conducive. About 70 mm of rainfall within a period of 20 days may be sufficient for triggering of flushing and flowering process in the plant, but once the process is set on, there should be continuous rainfall until fruit development starts. Any dry spell, even for a few days, within this critical period will result in substantial reduction of yield. Very long spells of dry weather are unfavourable for the crop growth.

The plant tolerates a minimum temperature of 10°C and maximum of 40°C,

the optimum being 20 - 30°C. It can be grown from sea level upto an altitude of 1200 m.

Pepper prefers a light porous and well-drained soil rich in organic matter. Water stagnation in the soil, even for a very short period, is injurious for the plant. So, heavy textured soils in locations where drainage facilities are inadequate should be avoided.

### Varieties

Improved varieties : Panniyur-1, Panniyur-2, Panniyur-3, Panniyur-4, Panniyur-5, Panniyur-6, Panniyur-7, Panniyur-8, Vijay, Subhakara, Sreekara, Panchami, Poumami, Girimunda and Malabar Excel. IISR Sakthi and IISR Thevam are tolerant to *Phytophthora* foot rot.



Local varieties: Karimunda, Neelamundi, Kottanadan, Kuthiravally, Arakulam Munda, Balankotta and Kalluvally.

#### Selection of site

Sites with slight to moderate slope are ideal for pepper cultivation, as they promote drainage. Slopes facing south are to be avoided as far as possible. When such slopes are to be used for cultivation, the young plants may be sufficiently protected from the scorching sun during summer.

#### Selection of mother plants

Cultivate varieties, which are proven to be highly productive. Select mother plants, which give regularly high yields and possess other desirable attributes such as vigorous growth, maximum number of spikes per unit area, long spikes, close setting of berries, disease tolerance etc. Selected mother plants should be in the age group of 5-12 years. Mark and label selected mother plants in October-November.

#### Raising of rooted cuttings

Pepper is propagated vegetatively from cuttings. Select runner shoots produced at the base of mother plants and keep them coiled and raised to prevent from striking roots in the soil. Separate them from the vines in February-March. Very tender and too hard portions of the shoots are to be avoided for planting. The shoots are cut into pieces with 2-3 nodes in each. Two node semi-hard wood cuttings are to be planted for rooting of pepper cuttings. Leaves, if any, are to be clipped off leaving a small portion of the petioles on the stem. Satisfactory rooting and survival of cuttings (over 70 per cent) could be achieved even without any hormone treatment. Plant the cuttings in polythene bags filled with potting mixture. The potting mixture is prepared by mixing two parts of fertile topsoil, one part of

river sand and one part of well rotten cattle manure. Substituting granite powder (a waste material from stone quarries) for sand in conventional potting mixture (2:1:1) is good for growth of pepper cuttings and is economical. Recommended for black pepper nurseries for large scale multiplication. Solarized potting mixture supplemented with nutrient solution (urea, superphosphate, MOP and magnesium sulphate in 4:3:2:1 ratio) and fortified with biocontrol consortia promotes growth and helps in production of disease free rooted cuttings. When polythene bags are used, sufficient number of holes (16-20) may be provided at the base to ensure good drainage. The cuttings should be planted at least one node deep in the soil. The cutting after planting should be kept under good shade. In large nurseries, pandals are to be constructed for this purpose. The cuttings are to be well protected from direct sunlight and frequent watering is recommended in the nursery to maintain a humid and cool atmosphere around the cuttings. Watering 2-3 times a day is sufficient. Heavy watering, which makes the soil slushy and causes water logging is to be avoided.

Partially composted coir pith and vermicompost (75:25) enriched with *Trichoderma* (in talc formulation,  $10^7$  cfu  $g^{-1}$  at the rate of  $10 g kg^{-1}$ ) is found to be an ideal potting medium for black pepper nursery for healthy planting material production using plug-trays (cell dimension of 7.5 x 7.5 x 10.0 cm) compared to conventional multiplication. It reduces the incidence of soil born diseases and aids easy transportation of seedlings.

#### Serpentine method of propagation

Three node cuttings planted in polythene bags are kept in a corner of the nursery. When the plant develops two leaves they are trailed horizontally in polythene bags containing potting mixture kept below each tender node.

Each node will be pressed into the mixture with polythene bags with 'V' shaped midribs of coconut leaves. As new shoots arise these will be trailed horizontally in polythene bags containing potting mixture. Upward growth of cutting is not arrested. Once twenty nodes get rooted first 10 bags in the rooted nodes will be separated by cutting at the internodes. The inter nodal stub will be pushed back into the potting mixture. These stubs also produce a second root system. Daily irrigation is to be given using a rose can. After three months it will be ready for planting in the main field. On an average 60 cuttings will be obtained in a year by this method from each mother cutting. Recommended in black pepper nurseries for large scale multiplication.

#### Field planting

Planting of standards is to be taken up in April-May with the onset of pre-monsoon showers. Karayam or Killingil (*Garuga pinnata*), Matti/Pongalyam (*Ailanthus* sp.), subabul (*Leucaenea leucocephala*) etc. are suitable standards for growing pepper. *Acacia auriculiformis* and *Artocarpus heterophyllus* are two multipurpose support tree species suitable for block cultivation of black pepper (*Piper nigrum* L.). Pepper yields are promising when trees are grown in high density (3 x 3m spacing; 1111 trees ha<sup>-1</sup>) block plantations. Both the tree species provide additional economic returns through timber yield at final harvest. Because of prevalence of *Erythrina* gall wasp avoid using *Erythrina* as standard. Only species tolerant to *Erythrina* gall wasp is *Erythrina variegata* (heavily thorny). In high altitude areas, dadap (*E. lithosperma*) and Silver oak (*Grevillea robusta*) can be successfully used as standard for pepper. Seedlings of subabul and silver oak are to be planted 2-3 years before planting pepper. The cuttings of standards are to be

planted in narrow holes of 40 to 50 cm depth. The spacing recommended is 3 m x 3 m on plain lands and 2 m between plants in rows across the slope and 4 m between rows on sloppy lands. The soil should be pressed well around the standards to avoid air pockets and keep the standards firm in the soil.

For planting pepper, prepare pits on the northern side of standards, 15 cm away from it. The pit size should be 50 cm x 50 cm x 50 cm. Fill the pits with a mixture of top soil and compost or well rotten cattle manure @ 5 kg per pit and 50 g of *Trichoderma*. With the onset of south west monsoon in June-July, plant 2 rooted cuttings in the pits at a distance of about 30 cm away from the standards. Press the soil around the cuttings and form a small mound sloping outward and away from the cuttings to prevent water stagnation around the plants. The growing portions of the cuttings are to be trailed and tied to the standards. Provide shade to the plants if the land is exposed and if there is a break in the rainfall. When pepper is trailed on arecanut, plant the cuttings 1.0 m away from palm and 1.5 m when coconut is used as the support. Trail the pepper vines on a temporary stake for 1-2 years. When they attain sufficient length to reach the tree trunk, remove the stake without causing damage to the vines and tie the pepper plants on to the tree trunk and trail them on it.

#### Management after planting

If the terrain of the land is sloppy or uneven, carry out contour bunding or terracing to prevent soil erosion. Carry out digging around the standards and vines at a radius of about 1 m from the base or in the entire plantation, twice during the year; the first at the onset of southwest monsoon and the second towards the end of northeast monsoon. Weeding around the plants is to be done according to necessity. However, in foot

rot affected gardens, digging should be avoided and weeds are removed by slashing. In the early stages, tie the vines to the standards, if found necessary.

Where pepper is grown in large areas, growing of cover crops like *Calapagonium muconoides* is recommended. When such cover crops are grown, they are to be cut back regularly from the base of the plants to prevent them from twining along with the pepper vines. Lowering of vines after one year's growth will promote lateral branch production.

Intercropping of pepper gardens with ginger, turmeric, colocasia and elephant foot yam is advantageous. Banana as an intercrop in yielding gardens reduces pepper yield. Therefore, this is not recommended beyond three to four years after planting of pepper vines. However, in the early years, banana provides shade to the young plants and protects them from drying up during summer months.

When pepper is grown in open places, shading and watering of the young seedlings may be done during summer months for the first 1 to 3 years according to necessity. The young plants may be completely covered with dry arecanut leaves, coconut leaves or twigs of trees until summer months are over. Mulching the basins of pepper vines during summer months is highly advantageous. Saw dust, arecanut husk and dry leaves are suitable mulching materials. Removal of unwanted terminal shoot growths and hanging shoots should be done as and when necessary.

Prune and train the standards in March-April every year to remove excessive overgrowth and to give them a proper shape. The effective height of the standard is to be limited to about 6 m. A second pruning of the standards may be done in July-August, if there

is excessive shade in the garden. PGPM soil application (50 g/vine) and spraying (2%) with consortium of PGPM helps to prevent phytophthora foot rot infestation.

#### Underplanting

After regular bearing for about 20 years, the vines of most varieties start declining in yield. The age of decline in yield varies with variety and agroclimatic and management factors. So underplanting should be attempted at about 20 years after planting or when a declining trend in yield appears. The old and senile vines can be removed 3-5 years after underplanting depending upon the growth of the young vines.

#### Manuring

Manuring for pepper vines is to be done in basins taken around the plant, 10-15 cm deep and 30-40 cm radius, depending upon the growth of the plants. Apply cattle manure/compost/green leaves @ 10 kg/plant / annum just at the onset of southwest monsoon and cover lightly with soil. It is desirable to apply lime at the rate of 500 g/vine in April-May, with the receipt of pre-monsoon showers, in alternate years.

Apply 10 kg FYM + 500g Neem cake + 500 g ash + 2 kg vermicompost with biofertilizer - *Azospirillum* & *P solubilizing bacteria* (20g).

Apply PGPR Consortia (50 g) consisting of 2 spp. of *Micrococcus* and 1 sp. of *Enterobacter* per vine which helps in growth promotion and disease suppression.

Recommended nutrient dosage for pepper (3 years and above) is:

N:P<sub>2</sub>O<sub>5</sub>:K<sub>2</sub>O g/vine/year

50:50:150 (general recommendation)

50:50:200 (for Panniyur and similar areas)

140:55:275 (for Kozhikode and similar areas)

Note: Apply  $\frac{1}{3}$  dose for one year old plants and  $\frac{1}{2}$  dose for two year old plants.

The fertilizers may be applied in two split doses, the first in May-June with the receipt of a few soaking rains and the second in August-September. Apply fertilizers in a circle of radius 30 cm around the vine in the case of plants trailed on erythrina (Nadan murukku) or teak pole (dead standard) soil application of zinc @  $6 \text{ kg ha}^{-1}$  as zinc sulphate or foliar spray of Zn @ 0.5 per cent during flowering and pin head stage of black pepper is recommended in zinc deficient areas of black pepper cultivation for increasing the yield and quality. Application of molybdenum @  $1 \text{ kg ha}^{-1}$  is

recommended for areas deficient in soil molybdenum availability.

#### Irrigation

Irrigating pepper plants of Panniyur-1 variety at IW/CPE ratio of 0.25 from November / December till the end of March and withholding irrigation thereafter till monsoon break, increases pepper yield by about 50 per cent. The depth of irrigation recommended is 10 mm (100 litres of water per vine per irrigation at an interval of about 8-10 days under Panniyur conditions). The water is to be applied in basins taken around the plants at a radius of 75 cm. The basins may be mulched with dry leaves or other suitable materials. The irrigation schedule for AEUs of Wayanad district is given below.

Parameters	Agro Ecological Units of Waynad District*		
	AEU-15 Northern High hills (Sandy Clay loam)	AEU-20 Wayanad Central plateau (Clay loam to Clay)	AEU-21 Wayanad Eastern plateau (Sandy to Sandy loam)
Quantity of Water/ irrigation/ vine in litres in a basin of 0.75 m radius**	25	35	20
Irrigation interval in days***	5 to 7	7 to 10	4 to 7

\* NBSSLUP classification (Nair et al., 2012).

\*\* Add 30 to 40% to the above values depending upon the conveyance and application efficiencies.

\*\*\* Shorter irrigation interval is for the months from March to May

#### Bush pepper

For production of bush pepper, two to four node semi hard wood lateral branches with orthotropic shoot from where they arise are to

be collected and planted in the nursery for rooting during June- July. Well rooted plants are used for field planting. The rooted cuttings are to be planted in pits or pots. Fertilizers can be applied @ 1.0, 0.5 and 2.0 g/

pot of N, P<sub>2</sub>O<sub>5</sub> and K<sub>2</sub>O respectively at bimonthly interval. Alternatively, application of 15 g groundnut cake or 33 g of neem cake can also meet the N requirement of the crop. The bushy nature of the plant will have to be ensured by proper pruning of the viny growth. The potted plants are to be kept preferably under partial shade. It is necessary that re-potting is carried out after every two years.

Irigating black pepper vines with 8 litres of water through drip per day during Oct - May enhances yield and quality in bush pepper with high B:C ratio. Recommended for bush pepper grown as intercrop in coconut gardens.

Plant protection

Pests

For the control of pollu caused by the flea beetle *Longitarsus nigripennis*, spray any one of the following insecticides namely, dimethoate or quinalphos at 0.05 per cent concentration. The spraying is to be given at the time of spike emergence (June-July), at berry formation (September-October) and once again at berry maturing stage, if needed. It can also be controlled by spraying cypemethrin 0.01 per cent twice, first at the berry formation stage and the second one-month after the first spray (Sept.-Oct.).

For controlling pepper leaf gall thrips, dimethoate 0.05 per cent may be used.

Three different types of scale insects are found infesting black pepper in high ranges of Idukki district. They are black pepper mussel scale (*Lepidosaphes piperis* Gr.) infesting all parts of vines, coconut scale (*Aspidiotus destructor* Sign) feeding from undersurface of leaf and soft scale *Marsipococcus marsupiale* Gr. confining to upper leaf surface. Infestation by mussel scale causes significant loss of yield as it affects all parts of plant including berries.

Two sprayings of dimethoate 0.05 per cent at fortnightly intervals after the harvest of berries effectively control black pepper mussel scale.

Soft scale (*Lecanium* sp.) is occasionally found to infest the foliage and vines at higher elevations. This scale insect can be controlled by spraying quinalphos 0.05 per cent. This treatment will be adequate to control the mealy bugs also. Root mealy bugs can be controlled by drenching the basins of vines with chlorpyrifos 0.075 per cent. Adequate precaution has to be taken to ensure that the insecticide solution reaches the root zone of the vines. Many of the vines infested by root mealy bugs are also likely to be infected with *Phytophthora* and nematodes. For controlling hard scale, spot application of dimethoate 0.1 per cent is recommended.

Two sprays of Azadiractin 5000 ppm at 15 days interval after the incidence of scale insect.

Thiamethoxam 0.013% two sprays at an interval of 15 days after incidence of scale insect is also recommended.

Top shoot borer can be controlled by spraying dimethoate (0.05 per cent) on the tender shoots and flushes. The spraying has to be repeated to protect newly emerging shoots and flushes.

For control of the burrowing nematode *Radopholus similis* and the root knot nematode *Meloidogyne incognita*, adopt the following measures:

- a. Use nematode free rooted cuttings for raising new plantations.
- b. Apply talc based formulation of *Bacillus macerans* @ 10g/vine in basins (10<sup>6</sup> cfu/g) at the time of planting of vines or just before the monsoon period in established plantations.

Drench carbosulfan 25 EC 0.1% @ 50 ml / polybag (1.5 kg potting mixture) for the management of plant parasitic nematodes in black pepper nurseries. Recommended dose of carbosulfan is compatible with *Trichoderma harzianum* and *Pochonia chlamydosporia*.

*Pochonia chlamydosporia* (MTCC 5412) bioformulation, a native nematode antagonistic fungus is recommended for field management of root knot nematodes (*Meloidogyne* sp.) and burrowing nematodes (to a lesser extent) infesting black pepper plants. The mode of application is 10 g formulation mixed with 2 kg of well decomposed farmyard manure or compost and applied to basin of the vine in the field. *Pochonia* is compatible with copper oxychloride and *Trichoderma harzianum* and does not have any non-target effects on other living beings.

#### Diseases

##### Phytophthora (Foot rot)

For controlling the disease, adopt the following management practices:

##### Phytosanitation

All infected or dead vines along the root system are to be removed and burnt. Wherever water stagnation is a problem, effective drainage of both surface and sub-soil is to be ensured. To avoid soil splash and consequent disease initiation and spread, a legume cover in the plantation should be ensured. Runner shoots are to be pruned or tied back to vines before the onset of monsoon. At the onset of monsoon, the branches of support trees may be lopped off to allow penetration of sunlight and avoid build up of humidity.

Apply 1 kg lime and 2 kg neem cake per standard per year as pre-monsoon dose.

The application of neem cake should be four weeks after lime application.

#### Chemical control

For the control of *Phytophthora* foot rot, any of the following control measures can be adopted.

1. After the receipt of monsoon showers (May-June), all the vines are to be drenched over a radius 45-50 cm with copper oxychloride 2 g l<sup>-1</sup> @ 5-10 litres per vine. This varies according to the age of the plant. A foliar spray with 1 per cent Bordeaux mixture is also to be given. Drenching and spraying are to be repeated just before the northeast monsoon. A third round of drenching may be given during October if the monsoon is prolonged.
2. After the receipt of a few monsoon showers (May-June), all the vines are to be drenched over a radius of 45-50 cm with (3 ml l<sup>-1</sup>) potassium phosphonate @ 5-10 litres per vine. This varies according to the age of the plant. A foliar spray with 0.3 per cent potassium phosphonate is also to be given. A second drenching and spraying with 0.3 per cent potassium phosphonate is to be repeated just before the northeast monsoon. If the monsoon is prolonged, a third round of drenching may be given during October.

#### Biocontrol

Inoculate pepper vines with native arbuscular mycorrhizal fungi, *Trichoderma* and *Pseudomonas fluorescens* at the time of planting in the nursery and field and apply during the pre-monsoon period in the established plantations to control foot rot. In the field, apply the biocontrol agents around the base of the vine (see the chapter on biocontrol agents against plant pathogens).

- Note: 1. All chemical control measures are prophylactic in nature and application of chemicals in advanced stages of disease will not be effective in combating the disease.
2. In *Phytophthora* sick fields, use only chemical control measures.

#### Replanting/rejuvenation

Total replanting has to be undertaken in gardens where the mortality is 50-60 per cent or above. Where the mortality is below 50 per cent, timely plant protection measures as described above should be given to all the existing vines as prophylactic measure and gaps filled up. Gap filling or replanting should be taken up only after a period of one year. At the time of replanting, soil drenching with copper oxychloride should be given. While replanting, farmers should be encouraged to use recommended varieties.

#### Fungal pollu (Anthracnose)

For the control of fungal pollu or anthracnose caused by *Colletotrichum gloeosporioides*, spray 1 per cent Bordeaux mixture, once before flowering starts (late June and early July) and then at berry formation stage (late August). Minimize shade in the garden.

Treat the cuttings before planting by immersing in a solution of carbendazim + mancozeb (1 g l<sup>-1</sup>) for 30 minutes and spray Bordeaux mixture (1%) alternating with carbendazim (1 g l<sup>-1</sup>) for effective control of *Colletotrichum* infection in nurseries.

Foliar spray of carbendazim @ 1g l<sup>-1</sup> or a formulation containing combination of carbendazim + mancozeb @ 1g l<sup>-1</sup> during the month of June can effectively control the disease.

Wherever *Phytophthora* foot rot management is undertaken properly, separate

control measures for pollu disease may not be necessary.

Note: Since Bordeaux mixture application for pepper is to be given mostly at a time when the monsoon is very active, it is to be ensured that a sticker is added to the fungicide. The cheapest and most effective sticker is rosin washing soda mixture.

#### Rotting disease

For control of rotting disease of cuttings in the nursery, VAM and *Trichoderma* can be applied in the potting mixture. VAM inoculum consisting of infected root bits and soils can be applied @100 cc per kg of potting mixture and *Trichoderma* @ 1g kg<sup>-1</sup> of potting mixture. For the control of foliar infection apply potassium phosphonate @ 3 ml litre<sup>-1</sup> at fortnightly interval. In case, biocontrol agents are not incorporated in the potting mixture, 1 per cent Bordeaux mixture spray at weekly interval may be resorted to. When the cuttings start germination, ensure good aeration in the nursery. Heavy watering, which causes water stagnation is to be avoided. Instead, light and frequent watering should be resorted to. Remove shade as soon as continuous rain sets in.

#### Phyllody

In certain pockets, instead of normal spike with berries, leaf-like structures are produced. This is caused by *Phytoplasma*. Such vines, if noticed, must be uprooted and destroyed. Planting material should not be collected from such vines.

#### Stunted disease

The symptoms due to this disease include shortening of internode and narrowing of leaves with mottling. Such leaves also become leathery and deformed. This is caused by a virus. Since the disease is systemic and

transmitted through planting materials, avoid collecting planting materials from such vines. Once it is noticed, uproot the vines to avoid further spread.

Waiting period of insecticide / fungicide

Dimethoate	20 days
Quinalphos	20 days
Mancozeb	30 days

Harvesting and processing

Black pepper

Black pepper of commerce is produced from whole, unripe but fully mature berries. The harvested berries are piled up in a heap to initiate browning. Then berries are detached from the stalk by threshing. Then they are spread on suitable drying floor. During sun-drying, berries are raked to ensure uniform drying and to avoid mould development. Drying the berries for 3-5 days reduces the moisture content to 10-12 per cent. The dried berries are cleaned, graded and packed in double lined gunny bags.

Blanching the berries in boiling water for one minute prior to sun drying accelerates browning process as well as the rate of

drying. It also gives a uniform lustrous black colour to the finished product and prevents mouldiness of berries.

White pepper

White pepper is prepared from ripe berries or by decorticating black pepper. Bright red berries, after harvest are detached from the stalk and packed in gunny bags. The bags are allowed to soak in slow running water for about one week during which bacterial rotting occurs and pericarp gets loosened. Then the berries are trampled under feet to remove any adhering pericarp, washed in water and then sun dried to reduce the moisture content to 10-12 per cent and to achieve a cream or white colour. White pepper is garbled, sorted and packed in gunny bags. Approximately 25 kg white pepper is obtained from 100 kg ripe berries.

HACCP protocol for pepper products

The product specific hazard analysis and critical control points (HACCP) worksheet for different spice products viz., garbled pepper, white pepper, dehydrated green pepper (DGP) and pepper in brine are shown in Table 27 (A).

Table 27(A) Critical control points at various steps of pepper processing line

	CCP1	CCP2	CCP3	CCP4
Product	All 4 products*	All 4 products*	All 4 products *	Pepper in brine
Process stage Hazard	Reception Mycotoxin	Reception Chemical residue	Metal detection Metal	Brining Chemical, Microbiological
Monitoring procedure	Vendor/farmer selection, sample testing & analysis		On-line inspection	
Prerequisite programme	proper handling and storage	GAP	-	GMP, SSOP
Post occurrence control	No effective technique	-	Metal detector	No effective technique
Corrective action	Avoid entry to the process line		Hold and review	Water quality testing

\*Common for garbled pepper, white pepper, DGP & pepper in brine



### Improved CFTRI method

Fully mature but unripe berries are harvested and boiled in water for 10-15 minutes to soften the pericarp. After cooling, the skin is rubbed off either mechanically or manually, washed and sun dried to obtain white pepper. Since no retting operation is involved, the product will be free from any unpleasant odour. However, white pepper produced by this method gives pepper powder of light brown colour due to gelatinisation of starch in contrast to pure white powder obtained by traditional method.

### Decorticated black pepper

This is a form of white pepper produced by mechanical decortication of the outer skin of black pepper. This is generally done when white pepper is in short supply. The appearance of decorticated kernel is inferior to traditionally prepared white pepper, but is satisfactory when ground. Also the milling operation requires considerable skill to avoid excessive volatile oil loss.

### Dehydrated green pepper

In this method, under-mature berries are harvested and subjected to heat treatment for inactivating the enzymes responsible for browning reaction. Then the berries are dehydrated under controlled conditions wherein maximum retention of green colour is obtained. Dehydrated green pepper after reconstitution in water resembles freshly harvested green pepper. The advantage is that the season of availability can be extended and the berries could be stored for a year or more. Dry recovery comes to 20 per cent.

### Canned green pepper

Green pepper after harvest is preserved in two per cent brine solution and the product is heat sterilized. This product has the additional advantage over dehydrated green

pepper in that it retains the natural colour, texture and flavour.

### Bottled green pepper

Green pepper is preserved without spoilage in 20 per cent brine solution containing 100 ppm SO<sub>2</sub> and 0.2 per cent citric acid. Addition of citric acid prevents blackening of berries.

### Cured green pepper

To overcome the disadvantages of poor texture and weak flavour of dehydrated green pepper and the high unit weight and packing cost of canned and bottled green pepper, cured green pepper has been developed. Berries are thoroughly cleaned in water, steeped in saturated brine solution for 2-3 months, drained and packed in suitable flexible polyethylene pouches.

### Freeze-dried green pepper

Most of the moisture from fresh tender green pepper is removed by freezing the berries at -30°C to -40°C under high vacuum. The colour, aroma and texture of freeze-dried green pepper are superior to sun dried or mechanically dehydrated green pepper. Freeze-dried green pepper has 2 - 4 per cent moisture and is very light.

### Pepper oil

Black pepper is crushed to coarse powder and steam distilled to obtain 2.5 to 3.5 per cent colourless to pale green essential oil which becomes viscous on ageing. It is used in perfumery and in flavouring. The drying percentage & oil content of KAU Varieties of Pepper are given as Table 28. Oil can also be distilled from white pepper but high price of white pepper and low oil yield do not favour its commercial production.

### Pepper oleoresin

Extraction of black pepper with organic solvents like acetone, ethanol or dichloro-ethane

Table 28. Drying percentage and oil content of Panniyur varieties of pepper

Properties	Variety						
	P 1	P 2	P 3	P 4	P 5	P 6	P 7
Drying %	35.3	35.7	27.8	34.7	35.7	32.9	33.6
Piperine %	5.30	6.50	4.80	4.40	5.30	4.94	5.57
Oleoresin %	11.78	12.20	10.40	11.30	12.33	8.27	10.61
Essential oil %	3.31	3.40	3.12	3.12	3.80	1.33	1.50

provides 10-13 per cent oleoresin possessing the odour, flavour and pungent principles of the spice. The content of the pungent alkaloid piperine ranges from 4 to 6 per cent in dry pepper and 35 to 50 per cent in oleoresin. When

freshly made, pepper oleoresin is a dark green, viscous, heavy liquid with a strong aroma. One kg of oleoresin when dispersed on an inert base can replace 15 to 20 kg of spice for flavouring purpose.

## TURMERIC (*Curcuma longa*)

Turmeric is a tropical herb and can be grown on different types of soil under irrigated and rainfed conditions. Rich loamy soils having good drainage are ideal for the crop. It is a shade tolerant crop with shallow roots suitable for intercropping and also as a component crop in the homesteads where low to medium shade is available.

### Preparation of land

Prepare the land to a fine tilth during February-March. On receipt of pre-monsoon showers in April, prepare beds of size 3 m x 1.2 m with a spacing of 40 cm between beds.

### Seed material

Whole or split mother rhizomes are used for planting. Select well developed, healthy and disease free rhizomes. Treat the rhizomes in any of the copper oxychloride fungicides and store in cool, dry place or in earthen pits plastered with mud and cowdung.

### Varieties

Cultivars: Tekurpetta, Sugantham, Kodur, Armoor, Alleppey.

Improved varieties: Suvarna, Suguna, Sudarshana, Prabha, Prathibha, Kanthi, Sobha, Sona, Varna, IISR Kedaram and IISR Alleppey Supreme (Resistant to leaf blotch).

### Season and method of planting

Plant during April with the receipt of pre-monsoon showers. Take small pits in the beds in rows with a spacing of 25 cm x 25 cm. Plant finger rhizomes flat with buds facing upwards and cover with soil or dry powdered cattle manure. The seed rate is about 2000-2500 kg ha<sup>-1</sup>.

### Manuring

Apply cattle manure or compost as basal dose at 40 t ha<sup>-1</sup> at the time of land preparation or by spreading over the beds after planting. Apply N:P<sub>2</sub>O<sub>5</sub>:K<sub>2</sub>O @ 30:30:60 kg ha<sup>-1</sup>. Full

dose of  $P_2O_5$  and half dose of  $K_2O$  may be applied as basal;  $2/3$  dose of N may be applied at 30 days after planting; and  $1/3$  N and remaining  $K_2O$  may be applied 60 days after planting.

Apply 20 t FYM + 2 t Neem cake + 1 t Ash + 4 t vermicompost/ha. Also use Azospirillum and P- Solubilising bacteria (20 g/bed 3X1 m) as nutrient supplement.

#### Mulching

Mulch the crop immediately after planting with green leaves @  $15 \text{ t ha}^{-1}$ . Repeat mulching after 50 days with the same quantity of green leaves.

#### After cultivation

Weed the crop thrice at 60, 120 and 150 days after planting, depending upon weed intensity. Earth up the crop after 60 days.

#### Intercropping

Chilli, maize and colocasia can be grown as intercrops.

#### Harvesting and curing

Time of harvest depends upon variety and usually extends from January to March. Harvest early varieties at 7-8 months, medium varieties at 8-9 months and long duration varieties at 9-10 months after planting.

#### Improved method of processing

**Cleaning:** Harvested turmeric rhizomes are cleaned off mud and other extraneous materials adhering to them and subjected to curing within 2-3 days after harvest so as to ensure the quality of the end product.

**Boiling:** Fingers and mother rhizomes will have to be boiled separately. Boiling is usually done in MS pans of suitable size. Cleaned rhizomes

(approximately 50 kg) are taken in a perforated trough of size 0.9 m x 0.55 m x 0.4 m made of GI or MS sheet with extended handle. The trough containing the rhizomes is then immersed in MS pan (1 m x 0.62 m x 0.48 m) containing clean water sufficient to immerse the rhizomes. The whole mass is boiled till the rhizomes become soft. The correct stage of cooking can be judged by piercing a wooden needle through the rhizome. If the rhizomes are properly cooked, the needle will pass through the rhizome without resistance. The cooked rhizomes are taken out of the pan by lifting the trough and draining the solution into the pan.

**Drying:** The fingers are then dried in the sun by spreading them as a thin layer on bamboo mats or drying floor. Artificial drying at a maximum temperature of  $60^\circ\text{C}$  gives a bright coloured product than that of sun drying especially for sliced turmeric.

**Curing of Turmeric:** Use turmeric boiler TNAU model 100 kg capacity especially for commercial growers and steam boil for 60 minutes. This method reduces drying time to 10 days and improves quality and cleanliness.

#### Polishing

In order to smoothen the rough and hard outer surface of the boiled dried turmeric and also to improve its colour, it is subjected to polishing. There are two types of polishing: hand polishing and machine polishing.

**Hand polishing:** The method of hand polishing is simple, which consists of rubbing turmeric fingers on hard surface or trampling them under feet wrapped in gunny bags. The improved method is by using hand-operated barrel or drum mounted on a central axis, the sides of which are made of

expanded metal mesh. When the drum filled with turmeric is rotated, polishing is effected by abrasion of the surface against the mesh as well as by mutual rubbing against each other as they roll inside the drum.

**Machine polishing:** This method consists of an octagonal or hexagonal wooden drum mounted on a central axis and rotated by power.

#### Turmeric oleoresin

This is obtained by the solvent extraction of the ground spice with organic solvents like acetone, ethylene dichloride and ethanol for 4-5 hours. It is orange red in colour. Oleoresin

yield ranges from 7.9 to 10.4 per cent. One kg of oleoresin replaces 8 kg of ground spice.

#### Plant protection

No major incidence of pest or disease is noticed in the crop. Shoot borers can be controlled by spraying 0.05 per cent dimethoate or 0.05 per cent quinalphos.

Leaf spot and leaf blotch can be controlled by spraying 1 per cent Bordeaux mixture or 0.2 per cent mancozeb. If symptoms of early wilt or rhizome rot appear, drench the soil with cheshunt compound or 1 per cent Bordeaux mixture.

## CAMBOGE (KUDAMPULI) (*Garcinia gummi-gutta* var. *gummi-gutta*)

*Garcinia*, the camboge tree is a big sized glabrous and evergreen forest tree commonly seen in the Western Ghats of Kerala, Kamataka, and also in Sri Lanka. The tree is very much adapted to hill tops and plain lands alike. But, its performance is best in river banks and valleys. It grows well in dry or occasionally waterlogged or flooded soils.

The economic part of the plant is its mature fruit, which is highly acidic. The extract obtained from the mature fruit rind, (-) hydroxy citric acid, attracts foreign markets, for its use in medicines controlling obesity.

#### Varieties

Amrutham, Haritham.

#### Planting materials

Grafts prepared through soft wood grafting or side grafting and healthy seedlings raised in the nursery are used for cultivation. If seedlings are planted, 50-60 per cent will be male and female takes 10-12 years

for bearing. Hence planting of grafts is advocated as they ensure maternal characters including early bearing tendency.

#### Propagation by seedlings

**Selection of mother trees:** Locate mother trees that give a steady annual yield with a mean fruit weight of 200-275 g, high acid and low tannin content. Collect seeds from freshly harvested and fully ripe fruits and wash in running water and spread in a thin layer under roof. By the 20<sup>th</sup> day, seeds will be ready for sowing. Sow seeds at the rate of two per bag in polybags during the month of August-September. Usually seeds start sprouting in the month of December but the sprouts become visible above the soil surface only by February. In order to avoid delayed germination, simple seed treatment methods can be employed.

**Method 1:** In this method, the processed seeds (after drying under shade) are given a mechanical treatment. Remove seed coats of

such seeds using a sharp knife without injuring the ivory coloured cotyledon. Sow these ivory coloured cotyledons afresh in polybags at a depth of 3 cm. Germination starts in 20-25 days after sowing.

Method 2: After removing the seed coats, treat the seeds with gibberellic acid @ 250 ppm for 6 hours and thereafter soak them in mancozeb @ 4 g per l for 2 hours. Sow the seeds in nursery bags and irrigate daily. Seeds germinate in 16-20 days.

Method 3: Second method followed by transfer of the seeds to a white polypropylene cover of size 20 cm x 25 cm along with 30-50 ml of filtered water. Tie the polybag along with the air inside tightly using a rubber band. Such seeds germinate in 10-12 days after sowing. In a polybag, about 500-750 seeds can be incubated at a time. Pick up the sprouted seeds and sow in the nursery bags kept under shade.

Keep the seedlings under shade. Irrigate them regularly on alternate days during summer months. After 3-4 months, place the seedlings under direct sunlight to trigger robust growth. At this age, apply FYM @ 50 g per bag. In six to seven months time, seedlings will be ready for planting.

#### Propagation by grafting

Two types of grafting methods are employed viz. soft wood grafting and approach grafting.

##### Soft wood grafting

Select scions only from specific elite trees regular in bearing, which produce high yield of large and quality fruits.

Collection of scion: Select straight growing, healthy, young shoots emerging from the primary branches with whorled leaf arrangement. Cut them to a length of 6-10 cm and store in polybags under humid condition. Remove leaves partly and shape the cut end

to a wedge of 3-4 cm length by giving slanting cuts on two opposite sides.

Preparation of rootstock: Stock-plants having 3-4 mm stem thickness are ideal for grafting. Behead the selected plants at two nodes below the terminal bud and remove all the leaves at the graft union. Use scion and rootstock of same thickness for grafting. Grafting: Insert the wedge of the scion into the cleft made on the rootstock and secure the graft joint firmly with a black polythene tape, 1.5-2 cm wide and 30 cm long.

Care in the nursery: Immediately after grafting, cover the plants with a transparent polypropylene cover and keep under shade. By the 30<sup>th</sup> day, grafts will establish and new leaves will start emerging. Remove the polythene cover and keep under shade. Water the grafts daily using rose-can or micro-sprinkler. Care should be taken to remove sprouts emerging from rootstock at frequent intervals. Three months after grafting the plants will be ready for planting in the main field. Just before planting in the main field, leave the grafts under open condition in 10-15 days for hardening.

##### Approach grafting

Here also stock plants having 3-4 mm thickness are preferred and they are brought to the place where the mother tree is located. Grafting is done as in other crops and is kept intact for 45 days by which time union occurs. Graft is detached from the mother tree in three steps. The main disadvantage is that only a limited number of grafts can be produced in this method. Forty five days after grafting, they will be ready for transferring to the main nursery for hardening. Grafts are to be watered daily using a rose-can or micro-sprinkler. Care should be taken to remove sprouts emerging from rootstock at frequent intervals. Leaf folding pests common in the nursery can be controlled by spraying with quinalphos @ 2 ml

$l^{-1}$  at monthly intervals. One year old grafts can be used for field planting.

### Planting

The plants can be raised as a pure crop or as a mixed crop in coconut and arecanut gardens. Take pits of size  $0.75\text{ m} \times 0.75\text{ m} \times 0.75\text{ m}$  in hard and laterite soils;  $0.50\text{ m} \times 0.50\text{ m} \times 0.50\text{ m}$  in sandy and alluvial soils, at a spacing of  $4\text{ m} \times 4\text{ m}$  for grafts and  $7\text{ m} \times 7\text{ m}$  for seedlings. In slopes of 15 per cent or more, for planting grafts, rows are spaced at 5 to 5.5 m and 3.5 m between trees in a row. For planting seedlings, rows are spaced at 8 to 12 m and at 6 to 8 m for trees in a row. Planting is generally done at the onset of monsoon showers. Under existing coconut plantation of 25 years and above, spacing shall be so adjusted that it should alternate with the palms in the rows. Under Kuttanad conditions, where bunds and channels alternate, planting can be done in between two palms. Fill the pits with topsoil and 5 kg of compost or well-decomposed cattle manure and 10 g of carbaryl 10 per cent dust, to avoid white ant attack, before planting. The graft union shall remain just above the ground level. Provide support to the young plants. One month after planting, gently remove the polythene tape around the graft union.

### Management of plantation

Clean the field free of bushes and thick shades. Weed once in three months and mulch the basin with black polythene or dry leaves to avoid drying.

### Manuring

Apply 10 kg cattle manure or compost per seedling / graft during the first year. Gradually increase the quantity so that a well-grown tree of 15 years and above receives 50 kg of

organic manure per year. Apply  $N:P_2O_5:K_2O$  mixture at the rate of 20:18:50 g/plant during the first year. Double the dose in the second year and gradually increase it to 500:250:1000 g/plant / year at the 15<sup>th</sup> year.

### Pruning

Grafts will grow fast from the second year onwards. Give strong support with casuarina poles at this stage. By fifth year, the tree will have 3 to 4 m height. At this stage, height of the plant may be maintained at 3.5 to 4 m and by seventh year at 4 to 4.5 m by pruning.

### Pests and diseases

Hard scales and beetles are found to infest the crop. Hard scales desap the leaves and tender shoots. Both the adult beetles and their grubs defoliate the crop inflicting heavy loss of yield. Control these pests by spraying dimethoate @  $1\text{ ml l}^{-1}$ . Leaf folders are very common in the nursery against which quinalphos @  $2\text{ ml l}^{-1}$  may be sprayed. Incidence of hoppers is observed on grafts and large trees. This causes withering of leaves, drying up of branches and yield loss. Control them by spraying dichlorovos 1 ml per litre of water. Sooty mould is seen associated with hard scales. Seedling blight in the nursery stage is very common. Control it by drenching nursery bed with 1 per cent Bordeaux mixture or using mancozeb @  $5\text{ g l}^{-1}$ . In grafts and large trees, sometimes, fungal thread blights have been observed to cause leaf and twig blight. Adopt proper pruning and spray 1 per cent Bordeaux mixture or mancozeb 0.3 per cent.

### Harvesting

Seedlings start bearing generally at the age of 10-12 years. Grafts start bearing from the third year onwards and will attain full

bearing at the age of 12 to 15 years. Flowering occurs in January-March and fruits mature in July. There are reports of off-season bearers, which bear two times a year, i.e., during January-July and September-February. Mature fruits, which are orange yellow in colour, drop off from the tree. Harvest mature fruits manually before they fall. Immediately after harvest, wash the fruits in running water and separate the fruit rind for processing.

#### Processing

Separated fruit rind is first sun dried and then either smoke-dried or oven-dried at 70-80°C. In order to increase the storage life and to impart softness, mix the dried rind with common salt @ 150 g and coconut oil @ 50 ml per kg of dried rind.

Garcinia powder: Drying of *Garcinia cambogia* juice into powdered particles gives a considerable reduction in volume, easy to use and is an effective method for prolonging the shelf life. Powder from fresh fruit juice along with standardized limit of additive, followed by spray drying could get powder which packed in Aluminium pouches gives a storability of above 7 months with good reconstitution properties.

Optimized parameters of production are spray drying at inlet air temperature of 180°C with the atomizer speed of 22000 rpm and feed rate as 5.5 l/h. The powder is packed in LDPE inserted in aluminium foil pouches and can be stored for 7 months with good reconstitution properties (wetting time, 80 S and solubility index <0.1mm)

## TAMARIND (*Tamarindus indica*)

The tree is particularly well adapted to semi-arid tropical regions, but can be grown in heavy rainfall areas too, provided the soil is well drained. It is adaptable to poor soil also.

#### Propagation technique

It is propagated by means of seeds, grafts and budding. Healthy seeds are sown in polybags and seedlings are transplanted at 40-60 cm height. Due to erratic bearing of seedling progeny, grafts are successfully used as propagules. Side grafting, inarching and patch budding are commonly practised. Budding is done on nine month old saplings for higher success.

#### Cultural operations

Plants of 40-60 cm height are planted during June to November at 10 m x 10 m spacing in pits of 1 m<sup>3</sup> size incorporated with 15 kg of FYM. Regular watering till the plants establish in the field is a must. Leader shoot is cut at 3

m above ground level to induce scaffold branches. Organic manures are generally used. Intercropping with vegetables, groundnut and sesame can be done till the fifth year.

#### Pests and diseases

Insects like *Tribolium castaneum* and fungi are serious problems in storage and field respectively. Spray application of Quinalphos 0.05 per cent at the time of fruiting, when infestation starts, can control the storage beetle.

#### Harvest and yield

Seedlings start to yield 8-10 years after planting, whereas grafts and budded seedlings give yield after 4-5 years. Stabilized yield of 250 kg/tree is obtained from 9-10 years onwards. Harvesting is done from January to April. There is also a tendency of alternate bearing as in the case of mango.

## BEVERAGES AND STIMULANTS

### ARECANUT (*Areca catechu*)

The arecanut palms grow under a variety of climatic and soil conditions. It grows well from almost sea level up to an altitude of 1000 m in areas of abundant and well-distributed rainfall or under irrigated conditions. It is grown in a variety of soils such as laterites, red loams and alluvial.

#### Varieties

Mangala, Sumangala, Sreemangala and Mohitnagar, VTLAH1, VTLAH2

#### Selection of site

Select sites with deep well drained soil without high water table. Provide adequate irrigation facilities.

#### Selection of mother palms

Select mother palms showing earliness and regularity in bearing, high percentage of fruit set and dwarf to semi-tall stature.

#### Selection of seed nuts

Select fully tree-ripe nuts from middle bunches during mid season. Discard nuts, which are undersized, malformed and low in weight.

#### Nursery techniques

Sow selected seed nuts soon after harvest in nursery bed with stalk-end up and with a spacing of 5-6 cm. Cover the seed nuts with sand and irrigate daily.

Transplant 90 days old sprouts having 2-3 leaves to the secondary nursery. Prepare secondary nursery beds of 150 cm width and convenient length. Apply cattle manure @ 5 t ha<sup>-1</sup> as basal dose. Transplant sprouts at a spacing of 30 cm x 30 cm. Provide shade by growing banana, *Coccinia indica* etc. or by means of artificial pandal. Plant banana in advance at a spacing of 2.7 m x 3.6 m when it is grown as a shade crop. Provide irrigation

during hot and dry periods and drainage during monsoon. Periodical weeding and mulching are necessary.

#### Selection of seedlings

Select good seedlings for transplanting in the main field when they are 12-18 months old. Selection of seedlings can be based on the selection index.

Note: Plant characters such as girth at the collar one year after transplanting and number of nodes two years after transplanting are highly correlated with yield. Removal of plants with poor collar girth and lesser number of nodes one and two years after planting respectively, will help to increase the yield potential of plantations.

#### Field planting

Plant tall, quick growing shade trees on the southern and western sides of the plantation to provide protection from sun scorching.

Plant seedlings in pits at a spacing of 2.7 m x 2.7 m with north-south alignment, the rows being deflected at an angle of 35° towards west. Dig pits of size 60 cm x 60 cm x 60 cm and fill up with rich topsoil to a level of 15 cm from the bottom. Plant seedlings at the centre of pit, cover with soil up to collar level and press around.

The planting is to be done during May-June in well-drained soils and during August-September in clayey soils. Banana may be planted between rows to provide shade in the initial stages up to 4-5 years.

#### Manuring

Apply green leaf and compost, each



@12 kg per palm per year from first year of planting onwards, during September-October.

Apply N:P<sub>2</sub>O<sub>5</sub>:K<sub>2</sub>O for adult palms @ 100:40:140 g/palm/year.

Apply 1/3 dose during first year, 2/3 dose during second year and full dose from third year onwards. Under irrigated conditions, apply fertilizers in two split doses, the first during September-October and the second during February. Under rainfed conditions, apply the second dose during March-April after the receipt of summer rains. Apply manures and fertilizers during September-October in circular basins of 15-20 cm depth and with a radius of 0.75-1.0 m from the palm. Apply the second dose of fertilizers around the base of palm after weeding and mix into soil by light forking. In acidic soils, broadcast lime @ 0.5 kg per palm once in two or three years and incorporate into soil by forking during March-April.

#### Irrigation and drainage

Irrigate the palms during hot and dry periods at regular intervals depending upon the soil type.

The palms should be irrigated once in four to seven days depending on the soil type and climatic factors. In west coast, where major area of arecanut gardens are irrigated, watering the garden once in seven or eight days during November-December, once in six days during January-February and once in three to five days during March-April-May is recommended. In each irrigation, give about 175 litres of water per palm. Where there is shortage of water, follow drip irrigation. Application of organic mulch to the garden helps conservation of soil moisture.

Construct drainage channels (25-30 cm deep from the bottom of pits) between the rows and drain out water during periods of heavy rainfall to prevent waterlogging.

#### Cultural operations

Keep the garden free of weeds and break up surface crust by light forking or digging after cessation of monsoon during October-November. In slopes, prevent soil erosion by terracing. Sow seeds of green manure-cum-cover crops such as *Mimosa invisa*, *Stylosanthes gracilis* and *Calapagonium muconoides* in April-May with the onset of pre-monsoon rains. Cut and apply them to the palms in September-October.

#### Intercropping and mixed cropping

Crops such as elephant foot yam, pineapple, pepper, betel vine, banana, guinea grass, cocoa, ginger and cardamom can be grown in arecanut gardens. While planting cocoa, a spacing 2.7 m x 5.4 m is recommended. In all cases, the intercrops should be manured adequately and separately.

#### Plant protection

##### Pests

##### Mites

Orange coloured mites can be controlled by spraying the bunches with dimethoate at 0.05 per cent.

##### Inflorescence caterpillar (*Batachedra* sp.)

Force open the inflorescence out of the enclosing spathe and spray malathion 50 EC (250 ml in 100 litres of water). Control slugs, which predispose inflorescence to the attack of caterpillar, by using bait of metaldehyde.

##### Root grub (*Leucopholis burmeisteri*)

Loosen soil around the base of palms to a depth of 10-15 cm and drench with chlorpyrifos 0.04 per cent suspension twice, one in May just before the onset of southwest monsoon and again in September-October towards the end of the monsoon. Repeat application for 2 or 3 years consecutively to secure a complete eradication of the pest.

## Diseases

### Koleroga (Mahali or fruit rot)

(Phytophthora palmivora)

Spray Bordeaux mixture 1 per cent on all bunches three times in a year, one just before the onset of southwest monsoon and the rest at 40 days intervals. If monsoon season is prolonged give a third spray. Use rosin soda adhesive to ensure tenacity of the spray deposit on treated substrate. Remove and burn all fallen and infected nuts.

### Bud rot (Phytophthora palmivora)

Remove and destroy affected spindle and leaves. In early stages of infection, scoop out affected rotten tissues by making longitudinal side splits and apply Bordeaux paste on the exposed healthy tissues or drench crown with 1 per cent Bordeaux mixture.

### Basal stem rot (Anabe) (Ganoderma lucidum)

1. Isolate affected palms by digging trenches 60 cm deep and 30 cm wide around, one metre away from the base and drench with calixin (0.08 per cent) or copper oxychloride (0.3 per cent).
2. Remove and destroy all severely affected palms and stumps of dead palms.
3. Drench the soil with 1 per cent Bordeaux mixture before planting healthy seedlings.
4. Discourage growing of collateral hosts of fungus such as *Delonix regia* and *Pongamia glabra* in the vicinity of gardens.
5. Apply 2 kg neem cake per palm.
6. Avoid flood irrigation and water flowing from infected palms to healthy palms.

### Yellow leaf disease

Together with the routine pest and disease control measures different management

strategies may be adopted to control yellowing of arecanut grown in the following topo sequences:

#### 1. Converted paddy fields

$\frac{60}{04}$  Provide deep drainage channels so as to keep the water below the root zone during monsoon.

$\frac{60}{04}$  150 g lime palm<sup>-1</sup> year<sup>-1</sup> may be applied in the basin opened during February.

$\frac{60}{04}$  A minimum of 10 kg palm<sup>-1</sup> organic manure as farmyard manure/compost may be provided.

$\frac{60}{04}$  Fertilizer application may be done @ 100:40:200g NPK palm<sup>-1</sup> year<sup>-1</sup> in two splits in February and September under irrigated conditions. A sulphur containing fertilizer either single super phosphate or ammonium sulphate or ammonium phosphate sulphate (Factamphos) should be used in the fertilizer schedule so as to include a minimum of 100g S palm<sup>-1</sup> year<sup>-1</sup>.

$\frac{60}{04}$  Magnesium sulphate @ 60 g, borax and zinc sulphate @ 20 g palm<sup>-1</sup> year should be included to yellowing affected palms.

#### 2. Garden land

$\frac{60}{04}$  150 g lime and a minimum of 10 kg organic manure, 60 g magnesium sulphate per palm per year may be applied as in case of converted paddy field.

$\frac{60}{04}$  Fertilizer @ 100:40:250g NPK palm<sup>-1</sup> year<sup>-1</sup> in two splits in February and September by way of including any sulphur containing fertilizer so as to supply a minimum of 100 g S palm<sup>-1</sup> year<sup>-1</sup>, under irrigated conditions, can be adopted.

#### 3. Terraced upland

$\frac{60}{04}$  150 g lime and a minimum of 15 kg organic manure palm<sup>-1</sup> year<sup>-1</sup> may be applied as in case of garden land.

**Fertilizer** @ 100:40:250g NPK in two splits in February and September, including any sulphur containing fertilizer source so as to supply a minimum of 100 g S/palm/year, 60 g magnesium sulphate and 20 g borax and 20 g zinc sulphate/palm/year under irrigated conditions can be adopted.

#### Band disease

Improve soil conditions by loosening hard soil strata, if present, by providing good drainage. Adopt adequate control measures against spindle bug, mealy bugs, scales and mites. Where the results of the above treatments are not found satisfactory, apply powdered mixture of copper sulphate and lime in equal quantities @ 225 g/palm twice a year at the base of affected palms. Application of borax @ 25 g/palm has been found to have an ameliorative effect.

#### Collar rot of seedlings

Improve drainage conditions in nursery beds and gardens. Drench spindle and base of seedlings with 1 per cent Bordeaux mixture in disease affected nursery or garden.

#### Dieback of inflorescence

Remove affected inflorescence immediately. Spray mancozeb ( $3 \text{ g l}^{-1}$ ) twice, one just after female flowers are set and again 15-28 days later. Aureofungin sol at 100 ppm concentration is also effective in controlling the disease.

#### Stem bleeding

Palms in the age group of 10-15 years are more prone to this disease. Symptoms appear on the basal portion of the stem as small discoloured depression. Later, these spots coalesce and cracks develop on the stem leading to disintegration of the fibrous tissues

inside. With the progress of the disease, a brown exudate oozes out from these cracks. High water table predisposes the palm to this disease.

Improvement of drainage and root feeding of 125 ml tridemorph (1.5 per cent) is suggested as control measure against this disease.

#### Sun scorch

Protect palms from southwest sun by wrapping stems with areca sheath or white-wash the exposed portion. Provide reinforcement to palms showing stem fissures. Grow tall, quick growing trees on southern and western sides of garden.

#### Nut splitting

This can be considered as a physiological disorder than a disease. Palms in the age group of 10-25 years are more susceptible. Symptoms are premature yellowing of the nuts when they are half to three-fourth mature. Later splits develop at the tips, which extend longitudinally exposing the kernel. Sometimes kernel also show splitting and malformation. Rarely the kernel inside may exhibit splitting without visual symptoms on the husk, resulting in nut fall. Hyper nutrition or sudden flush of water after a period of drought or insufficient moisture in the soil is the probable cause (s) of the disease.

Improvement of drainage in ill drained gardens and spraying of borax @  $2 \text{ g l}^{-1}$  of water are found effective in reducing the disease incidence.

#### De-husking

A simple de-husking device has been standardized by the CPCRI, Kasaragod. The output with this device is 60 kg of husked nuts in the case of dry nuts and 30 kg in the case of green nuts. The cost of the device is about Rs. 250/-

## BETEL VINE (Piper betle)

Betel vine requires a tropical climate with high atmospheric humidity. It can be cultivated in the uplands as well as in wetlands. In Kerala, it is mainly cultivated in arecanut and coconut gardens as an intercrop. The crop grows best on well-drained fertile soils. Waterlogged, saline and alkali soils are unsuitable for its cultivation. The crop also comes up very well in lateritic soils. Proper shade and irrigation are essential for successful cultivation of this crop. An annual rainfall ranging from 200 to 450 cm is ideal. The crop tolerates a minimum temperature of 10°C and a maximum of 40°C. Extremely low atmospheric temperature leads to leaf fall. Hot dry winds are harmful.

### Varieties

The important types are Thulasi, Venmani, Arikodi, Kalkodi, Karilanchi, Karpuram, Chelanthikarpuram, Koottakkodinandan, Perumkodi, Amaravila and Pramuttan.

### Season

There are two important planting seasons. The Edavakodi is planted in May-June and the Thulakodi in August-September.

### Preparation of land

Areas with good shade and irrigation facilities are preferred for this crop. The land is dug well and laid out into furrows of 10-15 m length, 75 cm width and 75 cm depth. Such furrows are opened at a distance of 1 m apart. Well rotten farmyard manure and leaves are thoroughly incorporated with the topsoil of the furrows, along with wood ash. High dose of organic manure (20-50 t ha<sup>-1</sup>) is applied to

maintain good soil structure, which is essential for the proper development of the root system.

### Planting material and planting

Top portions of mature vines (2-3 years old) are used for planting. Healthy cuttings of about 1 m length with three nodes are used as planting material. For planting one hectare, 20000-25000 cuttings are required. Furrows are irrigated prior to planting. Cuttings are planted in holes 20 cm apart in furrows. While planting, one node shall be buried in the soil and the second node should be at the ground level. The soil around the planted cutting must be pressed firmly to encourage quick germination. It is necessary to provide shade to the planted cuttings. Coconut leaves are used as shading material. To prevent excess moisture in the soil, splashing water on the vines by hand is preferable in the early stages. In the absence of rain, light irrigation, four times daily, is given till establishment. Cuttings establish in three weeks time and the first leaf emerges in about a month.

### Irrigation and drainage

Betel vine needs constantly moist soil, but there should not be excessive moisture. Hence, frequent light irrigations are given. The quantity of irrigation water should be such that the standing water should not remain for more than half an hour in the bed. If waterlogging by heavy rains or excess irrigation occurs, drainage should be arranged immediately. The best time for irrigation is morning or evening.

### Trailing the vines and weeding

The cuttings sprout and creep in about a month. At this time, they must be trailed on the

standards. Bamboo standards are erected at intervals and linked by tying at heights of 30 cm and 150 cm using coir rope. In the initial stages trailing is done on coir tied for the purpose. Trailing is done further by tying the vines, at intervals of 15-20 cm along the standards loosely with the help of banana fibre. When vines come in contact with standards, they produce adventitious roots using which they cling to support. Trailing is done every 15-20 days depending on the growth of vines. Gardens should be kept clean by weeding and stiring as and when required.

#### Manuring

Dried leaves and wood ash are applied to the furrows at fortnightly intervals and cowdung slurry is sprinkled. This is repeated till four months after planting when the crop is ready for harvest. Application of different kinds of leaves (gliricidia, mango leaves etc.) at monthly intervals is found advantageous for the growth of the vines.

#### Harvesting

In about 3-6 months time, vines grow to a height 150-180 cm. At this stage branching is noticed in the vines. Leaves are removed along with the petiole with the right thumb. Once harvesting is commenced, it is continued almost every day or week. The interval of harvesting varies from 15 days to about a month till the next lowering of vines. After each harvest, manuring has to be done.

#### Lowering the vines

Under normal conditions, vines grow to a height of about 3 m in one year time. When they reach this height, their vigour to produce normal sized leaves is reduced and the crop needs rejuvenation. This is done by lowering the vines down to the ground level at

least once a year. Lowering is done during the months of August-September. Before lowering, all the leaves in the basal portion of the vines to a height of 15 cm are removed. Vine is untied from bottom upwards and coiled up carefully and laid flat on ground leaving 2.5 to 5 cm length of top shoots. Soil is put over the portion kept in the soil to about 5 cm thickness. Lowering is followed by light irrigation and manuring.

#### Plant protection

The insect pests include the mirid bug (*Disphinctus politus*) which desaps the tender leaves and shoots, scale insects and mealy bugs (*Lepidosaphes* and *Pseudococcus*), which occur on the stems. Insecticidal application is not recommended to avoid toxic hazards. In serious infestations, apply fish oil soap at 1.5 per cent against the mirid bugs and 0.05 per cent quinalphos against the scale insects and mealy bugs. Against scale insects, restrict insecticide application on the stem only. The leaves should be harvested only after 15 days of insecticide application. The treated leaves should be consumed/marketed after thorough washing in water. Among the diseases, the bacterial leaf spot caused by *Xanthomonas betlicola* is most serious in southern Kerala. The initial symptoms appear as small watersoaked regions, which enlarge and turn dark brown in the centre with yellow halo. Profuse bacterial ooze may be seen on the lower side of the lesion. In severe cases, defoliation and stem injury occur, leading to wilting of the plant. The cultivars Karilanchi, Karpuram and Thulasi are found susceptible to the disease. Spraying 1 per cent Bordeaux mixture is recommended to control the disease.

## COCOA (*Theobroma cacao*)

The cocoa tree flourishes in the dense shade of warm rain forests in its natural habitat and hence can be cultivated in all similar climatic conditions. The tree cannot withstand high winds, drought or sudden fall in temperature. The crop requires well-distributed rainfall. The minimum requirement of rainfall is about 100-150cm per annum. Situations where the temperature falls below 10°C or rises above 38°C are unfavourable although minor deviations from the above limit can be adjusted by shade and irrigation. High wind velocity causes considerable mechanical damage to trees.

Cocoa is grown at altitude up to 900 m above MSL though it is possible to grow the crop even in much higher elevations under sheltered conditions.

The best soil for cocoa is forest soil rich in humus. The soil should allow easy penetration of roots and capable of retaining moisture during summer. Clay loams, loams and sandy loams are suitable. Shallow soils should be avoided.

### Varieties

Though three varietal types viz., Criollo, Forastero and Trinitario are recognized, only Forastero types are known to perform well under Indian conditions. Breeding work initiated at the Kerala Agricultural University since 1979 has resulted in the release of seven improved clones of Forastero type. These are CCRP 1, CCRP 2, CCRP 3, CCRP 4, CCRP 5, CCRP 6 and CCRP 7. These improved clones are suitable for cultivation in different cocoa growing tracts of the country and also in the warm tropical areas especially under the shade of coconut. All these

clones are tolerant to vascular streak dieback and have yield potential in the range from 55 to 180 pods per tree per year and mean yield from 38 to 78 pods per tree per year.

Hybrids : CCRP 8, CCRP 9, CCRP 10, CCRP 11, CCRP 12, CCRP 13, CCRP 14 and CCRP 15. These hybrids have mean yields of 90, 105, 79, 114, 138, 99, 120 and 86 pods per tree per year respectively. These are also tolerant/ moderately resistant to vascular streak dieback disease.

Cocoa exhibits self incompatibility and is highly cross pollinated. Therefore growing of different varieties adjacent to each other must be encouraged so as to achieve maximum fruit set and yield realization.

### Selection of site

Cocoa is usually planted under coconut and arecanut plantations in India. Shade levels under coconut canopy are highly variable depending mainly on the spacing of coconut, extent of canopy development and age of palms. It is estimated that light infiltration through coconut canopy ranges from about 30 to 80 per cent depending upon these factors. Based on this, the general recommendation is as follows:

1. If a choice is possible, a coconut plantation that will let in about 50 per cent light through the canopy may be chosen for raising cocoa.
2. If the light infiltration is over 50 per cent, it may be beneficial to provide additional shade using temporary shade plants like banana.

### Preparation of land

The seedlings / budded clones are usually planted in the interspaces of coconut/arecanut.

Give a spacing of 3 to 4.5 m. The crop is best grown with 50 per cent light intensity in the early stages. In the early life of the plants, planting of quick growing plants like banana and tapioca can provide temporary shade.

#### Planting materials

Cocoa can be propagated by seed and vegetative means.

#### Seed propagation

It is desirable to collect seeds from biclonal or polyclonal seed gardens involving superior self-incompatible parents to ensure genetic superiority of planting materials. Polyclonal and biclonal seed gardens have been established at CCRP farm of the Kerala Agricultural University, Vellanikkara and Kidu farm of CPCRI and seeds and seedlings are being supplied to growers. If seeds cannot be procured from such seed gardens, mother plants for collection of seeds may be selected based on the following criteria:

1. Trees of Forastero type having medium or large pods of not less than 350 g weight or 400 cc volume, green in colour when immature, having smooth or shallow furrows on the surface without prominent constriction at the neck should be selected. Yield of pods should be not less than 100 per year.
2. Husk thickness of pods to be not more than 1 cm.
3. Pod value (number of pods to give 1 kg wet beans) to be not more than 12.
4. Number of beans per pod to be not less than 35.
5. Bean dry weight to be not less than 1 g.

Seeds lose viability within a week of harvest of pods. Seeds are to be sown

immediately after extraction from the pods. Viability of the beans can be extended for some more days if freshly extracted seeds are stored in moist charcoal and packed in polybags. Other alternative is extracting beans, removing the testa and packing in polythene bags.

#### Time of sowing

Though the seeds will germinate at any time of the year, seeds may preferably be sown by December-January, so that 4-6 month old seedlings become available for planting by May-June.

#### Method of sowing

Seeds are to be sown with hilum-end down or to be sown flat. Sowing is to be as shallow as to just cover the seeds with soil. Removal of pulp may enhance the speed of germination, but the extent of additional advantage is only marginal. Seeds germinating in about a week and germination may continue for another week. Percentage of germination may be around 90.

Cocoa nursery is to be located in a heavily shaded area, which allows only 25-50 per cent sunlight. Regular watering is necessary to keep the soil moist.

Seedlings are transplanted after 4-6 months. Only vigorous seedlings are to be used and based on height and stem girth, 25 per cent poor seedlings may be rejected. When seedlings are grown under heavy shade, hardening for 10 days by exposing to higher illumination may be necessary before transplanting.

#### Vegetative propagation

In view of the high variability exhibited by seedling progenies, vegetative propagation is preferred for large scale planting. Though vegetative propagation of cocoa by budding,

rooting of cuttings and grafting are feasible, the widely accepted method in India is budding.

Scions for budding are to be collected from high yielding, disease resistant elite plants. Shoots having brown bark and just hardened leaves are selected as bud wood. Scions are preferably pre-cured by cutting off lamina of all the leaves of the selected scion shoot to a distance of about 30 cm from the tip. After 10 days when the petioles have fallen off, these scion shoots are cut and used for budding immediately. Bud wood can be stored by dipping in benzyl chloride followed by washing in water and then sealing the cut ends using molten wax. Bud wood is then wrapped in moist cotton wool and in turn in wet tissue paper or blotting paper and packed in boxes with wet packing material. The packet is then covered using polythene sheets. Storage life of the bud wood can be extended up to 10 days by this method. As far as possible, bud wood is to be collected from chupons as those produced from fans may develop into bushy plants with spreading habit. Rootstock, six to twelve months old may be selected in such a way that scion and rootstock are of the same thickness. Different successful methods include T, inverted T, patch and modified Forkert methods. Patch budding is adopted in the Kerala Agricultural University.

Patch budding method consists of removing a patch of about 2.5 cm length and 0.5 cm width from the rootstocks, preparing a bud patch of 2.5 cm length and 0.5 cm width from the bud wood and inserting it into the rootstock and tying firmly with polythene tape. After three weeks, if there is bud-take, polythene tape is removed; a vertical cut is made half way through the stem above the bud and is snapped back. The snapped root stock portion is cut back after the bud has grown to a shoot and at least two leaves have hardened. It is then allowed to grow for a

further period of three to six months after which they are transplanted. Under normal conditions, success can be around 70-90 per cent.

#### Selection of planting materials

When seedlings are used for planting, select only vigorous and healthy seedlings produced from polyclonal seed garden or selected mother plants as described earlier. When budded plants are used, select two or more clones for planting as the use of a single clone can lead to poor production due to the existence of self-incompatibility in cocoa.

#### Time and method of planting

Raising cocoa as a pure crop is not recommended especially in Kerala due to high pressure on land. Cocoa is planted as an intercrop in coconut and arecanut gardens. In coconut, depending upon the spacing adopted, one or two rows of cocoa can be planted in between two rows of coconut i.e., two rows where the spacing is more than 8 m and one row otherwise, the plant distance for cocoa being 2.7 to 3 m. When two-row system is adopted, the seedlings may be planted in zigzag or triangular manner.

In arecanut where the normal spacing is 2.7 m, cocoa is planted at the centre of four areca palms along alternate rows of inter-spaces only. Pits of 50 cm x 50 cm x 50 cm are dug, allowed to weather for one month and refilled with topsoil and 15-20 kg of compost or FYM to ground level. The planting hole should be sufficient to hold the soil ball of the polybag. Tear off the polybags carefully, place the soil ball with the seedlings in the planting hole with minimum disturbance and press the soil around firmly. Planting should coincide with the onset of monsoon, but in places where irrigation is resorted to, flexibility in the time of planting is possible.



### Shaping of clonal plants derived from fan shoots

Budded plants from fan shoots have diffuse branching system and bushy growth habit. This type of growth causes difficulties in carrying out cultural operations and harvesting. If a better shape of the plant is desired, appropriate formation pruning may be necessary. This involves identification of a chupon arising from a fan shoot, allowing it to grow and removing the original, lower fan-like shoots in stages. This, however, has to be done slowly as an early drastic pruning will inhibit growth.

### Manuring

Apply  $N:P_2O_5:K_2O$  in two equal split doses in April-May and September-October, @ 100:40: 140 g / tree / year.  $N:P_2O_5:K_2O$  may be applied @ 200:80:280 g / plant / year, in trees yielding more than 60 fruits per year. Dolomite @ 100 g / plant / year may be applied to plants from the third year onwards.

Under irrigated conditions, the yearly dose may be split into four and applied during April-May, September-October, December and February-March.

Apply  $1/3$  of adult dose during the first year of planting,  $2/3$  during second year and full dose from the third year onwards.

Apply fertilizers in circular basins with a radius of 25 cm during the first year. Gradually increase the radius of the basin to 120 cm by the third year. Apply fertilizers in the entire area of 1.5 m radius around the tree followed by forking in.

Plants showing zinc deficiency symptoms (narrowing of leaves, sickle leaf formation, green vein banding, chlorosis in the interveinal areas) should be sprayed with 0.5 to 1.5 per cent  $ZnSO_4$  three times a year.

### After cultivation

During the first three or four years after planting, it is essential to keep the field free from weeds. Maintenance and regulation of shade should be carried out promptly. During the establishment phase of the crop particularly in summer, provide mulching with materials like chopped banana sheath, coconut husk, cocoa husk etc. to conserve moisture in conditions of direct insolation. A mature cocoa plantation should form a proper canopy, which will be dense enough to prevent weed growth. Operations such as pruning and regulation of shade should be attended to in time.

### Pruning and training

Cocoa grows in a series of storeys, the chupon or vertical growth of the seedling terminating at the jorquette from where four to five fan branches develop. Further vertical growth is continued through a side chupon that arises from a point just below the jorquette which again jorquettes after growing to some height. Left for it, the plant will grow to a height of 8-10 m repeating this process of jorqueting and chupon formation 3-5 times.

When cocoa is grown as an intercrop in coconut and arecanut plantation, it is desirable to restrict the growth to one tier formed at a convenient height preferably above the head level of the workers. When jorqueting takes place at lower levels this can be raised by nipping off all the fan branches and allowing one chupon to develop and grow further to jorquette at the desired height. After this is achieved, further vertical growth is arrested through periodical removal of chupons.

The intensity of pruning is to be decided by the nature of growth of individual trees, shade intensity, growth of the companion crops etc.

In the early stages, pruning is done to give a particular shape to the tree. After the establishment of the trees in the garden, prune them to the extent of retaining only the required number of leaves (20-30 leaves per developing pod). Removal of secondary branches from the centre should be restricted only to those trees growing in excess shade.

#### Irrigation

Cocoa grows well as a rainfed crop under conditions of well distributed rainfall and irrigation is not necessary. If sufficient moisture is not present in the soil due to prolonged drought or failure of rains, irrigation is to be given once in five days. Irrigation, however, helps in better growth of plants and precocity in bearing.

#### Top working

This technique is useful to rejuvenate old and unproductive cocoa plants and also to convert genetically poor yielders to high yielders. This consists of snapping back the desired trees below the jorquette after cutting half way. The snapped canopy continues to have contact with the trunk. A number of chupons would arise below the point of snapping and this is triggered by the breakage of apical dominance and continued connection with the snapped canopy. Patch budding as described earlier may be done on three to four vigorous and healthy shoots using scions from high yielding, disease resistant clones and the remaining chupons are removed. The polythene tape is removed three weeks after budding and the stock portion above the bud union is snapped back. The snapped portion is removed after two hardened leaves develop from the bud. When sufficient shoots are hardened, canopy of the mother tree can be completely removed. Because of the presence of an established root

system and the trunk with reserve food, the top worked trees grow much faster and give prolific yield one year after the operation. Though top working can be done in all seasons, it is preferable to do it in rain-free period in irrigated gardens. For rainfed situations, it may preferably be done after the receipt of pre-monsoon showers.

Top worked trees start yielding heavily from the second year onwards. About 50 per cent improved yield is obtained in the second year and about 100 per cent improved yield in the third year. Loss of crop for one year during the operation is compensated by bumper crop in the coming years. The main stem will continue to belong to the older plant and fruits borne on this area belong to the poor yielder. Better yields are however obtained from the fan branches of the high yielding clone used for top working.

#### Plant protection

##### Pests

##### Red borer (*Zeuzera coffeae*)

Larvae burrow into the main stem of young plants and fan shoots of older trees, causing drying up.

##### Management

Prune off and burn affected fan shoots.

##### Striped squirrel (*Funambulus* sp.)

The squirrels gnaw the bronzing pods and extract the beans along with mucilaginous pulp.

##### Management

Harvest the crop just when bronzing is visible in the pod furrows. Mechanical protection of the pods can be ensured by covering them with punched polybags (150 gauge) smeared with bitumen-kerosene mixture.

### Rats (*Rattus rattus*)

Rats are serious pests in densely planted coconut gardens with cocoa as an intercrop. They inhabit the coconut palm crowns and descend during night and cause damage to pods. Nature of damage is similar to that caused by squirrels.

#### Management

Baiting with anticoagulant rodenticides in the garden is recommended. Rain-proof preparations are to be used. Set up bamboo traps with bow attachment on the crown of palms.

### Myllocerus weevils (*Myllocerus viridanus*)

Adults skeletonise the foliage and this is serious in young plants during July-September. Spray undersurfaces of the foliage with quinalphos 0.05 per cent.

### Mealy bugs (*Planococcus citri* and *Rastrococcus* sp.)

The bugs occur in cherelles, developing pods and shoots and desap the tissues. This can be controlled by spot application of quinalphos 0.05 per cent or phosalone 0.07 per cent.

### Aphids (*Toxoptera aurantii*)

Colonies of pink aphids occur ventrally on the leaves of chupon shoot. Tender shoots are also damaged.

#### Management

Nip off the flaccid leaves along with the shoots and destroy the colonies.

### Cockchafer beetle (*Popillia* sp. and *Leucopholis* sp.)

Grubs feed on the roots of freshly planted seedlings causing wilting.

The pods are damaged by *Helopeltis* sp. The pest can be controlled by spraying quinalphos 0.05 per cent.

### Diseases

#### Seedling blight (*Phytophthora palmivora*)

The symptoms develop on the leaves and stem of the seedlings or budded plants. On leaves, small water-soaked lesions appear which later coalesce resulting in the blighting of leaves. On stem, water-soaked linear lesions develop initially and later turn to black colour. Stem infection develops at any point on the stem causing the death of seedlings / budded plants.

#### Management

Remove and destroy severely affected seedlings. Improve drainage and adjust shade. Spray with 1 per cent Bordeaux mixture or 0.2 per cent copper oxychloride or 0.3 per cent potassium phosphonate just before the onset of monsoon and thereafter at frequent intervals.

#### Phytophthora pod rot / black pod (*Phytophthora palmivora*, *P. citrophthora*, *P. capsici*)

Fruits at all stages of maturity may be attacked by *P. palmivora*. The first visible symptom is the appearance of a circular brown spot, which enlarges concentrically and evenly to involve the whole pod surface. Ultimately the colour of the affected pod becomes dark brown or black. In immature pods, the discolouration spreads internally with rotting of the beans. The beans in mature pods may remain partly or wholly unaffected.

#### Management

Periodically remove and destroy all dried up and infected pods. Spray 1 per cent Bordeaux mixture with adhesive (rosin washing soda preparation) with the onset of monsoon and also at frequent intervals. Provide proper drainage and regulate shade to increase aeration.

*Lasiodiplodia* pod rot / charcoal pod rot  
(*Lasiodiplodia theobromae*)

The disease occurs more frequently during dry season. Pods of all stages are affected. The symptoms appear as pale yellow spots from the stalk-end or tip of the pod. Later, the lesions enlarge and cover the entire pod having chocolate brown colour. In due course, the whole pod develops a black sooty appearance due to formation of spores of the fungus.

Management

Since the disease is more common on pods of plants under stress, better management practices will reduce the incidence of the disease. Remove all affected pods and spray 1 per cent Bordeaux mixture.

*Colletotrichum* pod rot (*Colletotrichum gloeosporioides*)

The disease causes rotting of immature pods. Infection starts from the stalk-end of the pod and spreads towards tip as dark brown discoloration with a diffused yellow halo. Internal tissues of the pod also show discoloration. The whole pod turns to black and remains on the tree in a mummified form. Sometimes, infection may start from parts other than the stalk region as dark brown sunken lesion.

Management

Remove all infected pods and spray with 1 per cent Bordeaux mixture or 0.2 per cent copper oxychloride or mancozeb.

Phytophthora canker  
(*Phytophthora palmivora*)

The earliest symptom is the appearance of greyish brown water-soaked lesion with dark brown to black margin anywhere on the stem. A reddish brown liquid oozes out from the

lesions, which later dry up to form a rusty deposit. The internal tissues beneath the outer greyish brown lesion appear as reddish brown. The wood shows greyish brown discoloration with black streaks. Wilting occurs, when canker girdles the affected stem / branches.

Management

If the disease is detected early, remove and destroy the affected tissues completely and apply Bordeaux paste. Wilted branches should be cut and removed. Since canker mainly develops from pod rot caused by *Phytophthora*, proper control measures of *Phytophthora* pod rot will help in reducing incidence of the disease.

Pink disease (*Corticium salmonicolor*)

The disease appears as a pinkish powdery coating on the stem of affected plants.

The pink colour represents profuse conidial production by the fungus. The fungal growth may rapidly spread and girdle the stem, so that the distal parts are affected. The extent to which the leaf may wilt, turn brown and fall depends on the part of the tree, which is affected. The disease mainly affects the forking region and the damage is localized. Splitting of the bark on the affected region is also noticed. Sometimes, the fungus produces pustules (Necator stage), which are orange red in colour and are arranged in rows along the stem.

Management

Remove all the infected and dried branches. Apply Bordeaux paste at the fork region and at the cut ends of the twigs and spray with 1 per cent Bordeaux mixture before the onset of monsoon. Repeat spraying again once or twice during the monsoon season according to the intensity of the disease.

### Vascular Streak Dieback (VSD) (*Oncobasidium theobromae*)

The first indication of the disease is the characteristic chlorosis of one or two leaves on the second or third leaf behind the tip. Leaves on the tip show symptoms first only in very young seedlings or in slow growing seedlings or branches. The chlorotic patches on the diseased leaves develop into small sharply defined green spots scattered over a yellow background. Diseased leaves fall within a few days after turning yellow. Leaves above and below the first diseased leaf soon begin to show yellowing with green patches and these also fall off finally resulting in dieback of the infected branches.

Leaf scars from the fall of chlorotic leaves are sometimes covered by a white, loosely adherent fruiting body of the fungus. These fruiting bodies have been found only on leaf scars and adjacent bark in the diseased region of cocoa stems. If the diseased stem is split longitudinally, the xylem is found to be discoloured by brown streaks.

#### Management

Cut and remove all infected twigs. Prune off all affected branches 30 cm below the last point of visible vascular streak of the stem to prevent further spread within the plant. Grow VSD tolerant cocoa types.

### White thread blight (*Marasmiellus scandens*)

The white mycelial threads of the fungus spread longitudinally and irregularly along the surface of the stem of young branches and enter the leaf along the petioles. On the leaf lamina it spreads extensively and forms a much branched system of fine threads. The affected leaves turn dark brown and such dead leaves eventually get detached from the stem, but are

found suspended by the mycelial thread. Extensive death of the young branches and suspended leaves in rows are the common field symptoms.

#### Management

Remove and destroy the affected plant parts. Avoid heavy shade. Spray 1 per cent Bordeaux mixture.

#### Harvesting

It takes about 170 days for a cocoa pod to develop from formation to maturity. During the period from 70-140 days after pollination, the size of pods and their fat and sugar content increase rapidly. Ripening takes about 25 days, during which, the pods change colour depending on the variety. Pods remain suitable for harvesting for fairly long time after they have ripened. Hence, it is possible to have harvest of sufficient number of pods at a time by either delaying the harvest of early ripened pods or harvest of pods, which are fully ripened. Harvesting should be done at regular intervals rather than daily, once in 7-10 days. Avoid over ripening of pods. The discards at the harvest can be left in the garden either in the open during summer or in pits at different sites in the rainy season or they can be incorporated in the compost. Pod husks from the fermentary can also be used similarly as a good source of organic manure.

Pods are removed by cutting with a sickle-sharp knife, without damaging the cushion from which it is developed. After 2-3 days, they are split by banging them against some hard objects. Opening the pods with a knife damages the beans. During the period between harvesting and splitting, pre-fermentation activity inside the pod is hastened, which improves later fermentation. Beans from the split pods are scraped out with fingers. Portions of placenta broken, germinated, caked, parthenocarpic and

undeveloped beans are removed. On an average, 10-12 pods give 1 kg of wet beans and 3 kg of wet beans (from 30-36 pods) give 1 kg of fermented and dried beans.

#### Fermentation

During fermentation, the pulp or mucilage covering the fresh beans is removed and characteristic chocolate flavour is imparted to the final produce. The process is simple but must be carried out properly in order to get beans of good quality. Heat is produced by keeping the fresh beans compactly and this heat must be conserved so that chemical changes inside the bean can be completed. The four methods of fermentation usually employed involve the use of baskets, heaps, boxes and trays for filling up the wet beans.

#### Tray method

The best method suitable for small quantities of beans is the tray fermentation. Wooden trays, 10 cm deep with slatted / split cane bottoms are divided into a number of sections by means of wooden partitions that fit into appropriate grooves at required distances. The capacity of the tray can be adjusted depending upon the availability of beans by keeping the wooden plank in the appropriate grooves. A convenient tray can be 25 cm wide and 60 cm long. Wet beans are filled in the tray and levelled. About 10 kg of wet beans may be required to load one tray fully.

A single tray of beans will not ferment properly and at least four or five trays are needed for successful fermentation. The trays are stacked one over the other in such a manner that the cocoa filled portions are in a single row one above the other. The top tray is covered with plantain leaves. After 24 hours, a close fitting sack is put to cover

the stack to keep the beans warm. Mixing or stirring of beans is not necessary and fermentation gets completed in 4 to 5 days, whereas 6 to 7 days are required for other methods of fermentation.

#### Basket method

In this method, bean lots ranging from 2-6 kg can be fermented successfully. Mini baskets may be made of bamboo matting, closely woven and should have a diameter of 20 cm and height of 15 cm for a capacity of 2 kg. For slightly larger lots, proportionately deeper baskets may be used (e.g., for 6 kg, the depth may be about 40 cm). The baskets are lined with one or two layers of torn banana leaves to facilitate drainage of sweatings. Wet beans are then filled, compacted and covered with banana leaves. The baskets are placed on a raised platform to allow the flow of drippings. After 24 hours, it is covered with gunny-sack and apply weight (bricks). The beans are to be taken out and stirred well 48 hours and 96 hours after the initial setting. Fermentation will be completed in six days and the beans can be taken for drying on the seventh day.

A number of factors influence the duration of fermentation. Weather changes and season are important through their influence on temperature and atmospheric moisture. Ripening also affects fermentation. Beans from unripe pods cannot be fermented. Beans of Criollo ferment more quickly than those of Forastero. During the early stages of fermentation, heat is produced by the action of anaerobic microorganisms. The beans are killed by the combined effect of heat and acetic acid and the cocoa aroma and flavour potential are developed.

### Judging the end point of fermentation

Well-fermented beans will be plumpy and filled with a reddish brown exudate. The testa becomes loosened from the cotyledons. When cut open, the cotyledons will have a bleached appearance in the centre with a brownish ring in the periphery. When above 50 per cent of beans in a lot show the above signs, it can be considered as properly fermented.

### Drying

On completion of fermentation, beans are dried either in the sun or by artificial means. Sun drying can be done in thin layers 2-3 cm deep and stirring from time to time. Under normal sunny weather, drying can be completed in four to five days. While drying in mechanical driers, care must be taken to avoid exposure of the beans to smoke, fumes etc. The most common method of determining bean dryness is to take a sample and compress this in the palm of the hand and listen for the characteristic sound, which is associated with correctly dried cocoa. The more scientific method is to use a moisture meter.

### Storage

The dried beans with moisture content of

6-8 per cent may be packed in polythene bags or polythene lined gunny bags. Some special conditions have to be provided in storage in order to maintain the quality of the cured beans. Properly dried beans can be kept in 200-300 gauge polythene covers if only small quantities are involved or in polythene lined gunny bags in the case of larger stocks. Beans should be cleaned of flat, broken and other defective beans before storing. The store should be sufficiently ventilated and the bags should be kept on a wooden platform with air space of about 15-20 cm below the wooden planks set over the floor. The humidity should not exceed 80 per cent so as to prevent mould development and pest incidence in the beans. Before storing cocoa, the store can be made clean and insect free by application of pesticides well in advance, but pesticides should neither be applied nor be kept with the beans inside the store. As cocoa beans can absorb and retain permanently any odour from its surroundings, other food-stuffs should not be kept with cocoa. So also, smoke or kerosene fumes should be prevented from entry.

## COFFEE (*Coffea* spp.)

The soil and climatic requirements for Arabica and Robusta varieties are as follows:

### Arabica

Elevation : 1000-1500 m above MSL  
 Annual rainfall : 1600-2500 mm  
 Blossom rain : March-April (2.5-4.0 cm)  
 Backing rain : April-May (5-7.5 cm)  
 Shade : Medium to light  
 Temperature : 15-25°C  
 RH : 70-80 per cent

### Robusta

Elevation : 500-1000 m above MSL  
 Annual rainfall : 1000-2000 mm  
 Blossom rain : Feb-March (2.0-4.0 cm)  
 Backing rain : April-May (5-7.5 cm)  
 Shade : Uniform thin  
 Temperature : 20-30°C  
 RH : 80-90 per cent

In both cases, soil should be deep, friable, and rich in organic matter with a pH of 6.0-6.5.

### Preparation of land

If it is a jungle, only selective felling of trees is done maintaining the trees, which are desirable at appropriate spacing. The undergrowth may be cleared to enable line marking with a base line and opening of pits. The entire plot may be conveniently divided into blocks with roads and footpaths.

In April, pits of 45 cm x 45 cm x 45 cm may be opened at appropriate spacing for different coffee cultivars as described below.

Tall arabica like S 795, S 288 : 2.1 m x 2.1 m

Semi-dwarfs like Cauvery : 1.8 m x 1.8 m

Dwarfs like S 7 (San Ramon): 1.5 m x 1.5 m

Hybrids like Congensis x  
Robusta (CxR) : 2.5 m x 2.5 m

Robusta selections like  
S 274, BR series : 3.0 m x 3.0 m

The pits after digging will be kept open for weathering for a couple of months until monsoon. In June, the pits are covered with top soil and staked. In poor soils, 250 g of FYM or compost per pit may be added before filling.

### Planting materials

Old arabica varieties like Kents and Coorgs are more susceptible to the leaf rust disease (*Hemileia vastatrix*). Arabica selections of tall, medium and dwarf habit are grown on large scale because of their proven performance in yield and comparatively better resistance to leaf rust disease. In dwarfs, San Ramon (S 7, 7.1, 7.2 and 7.3) and in medium size bushes, Cauvery (Catimor) are the popular varieties. Some of the arabica selections like Sln 5, 6 and 7 are location specific while S.795 (tall) is adapted to all areas. All arabicas are susceptible to leaf rust with varying degree of susceptibility. Sln.5, Sl.6, Sln.9 & Chandragiri

are tolerant. Arabica varieties recommended for Nelliampathis & Idukki regions are S.6, Sln.9, Chandragiri while Cauvery & S.795 are discouraged. Chandragiri should be planted at elevations of 3000 feet (915 meters) and above. All Arabica varieties are discouraged in Wayanad. Robusta varieties recommended for Wayanad, Nelliampathis & Idukki are S.274 & CxR (Congensis x robusta hybrid). Generally robustas are tolerant to leaf rust disease and resistant to White Stem Borer pest, which are more on record in arabica. However, mealy bug incidence will be more in robusta.

### Propagation

In coffee, generally the propagation is done through seeds and of late in robusta, the clonal propagation was also established to be successful. To a limited extent, grafted plants are also being planted.

From the selected and certified seed blocks, healthy and fully matured fruits of normal appearance with three quarters of ripening are harvested selectively from the marked plants during November-December in the case of arabicas and in January-February in robustas. Discarding the floats, the sound fruits are pulped and sieved to remove the defective beans. The beans are then mixed with wood ash @ 0.75 kg per kg of seeds and dried under shade stirring from time to time to facilitate uniform drying. To protect the seeds against any microbial infection, the seeds are treated with either carbendazim @ 1 g or with vitavax @ 0.66 g per kg of seed coffee.

### Sowing

**Germination bed (primary):** Seeds are sown in raised seed beds (15 cm above the ground level) provided with proper drainage prepared out of soil, compost and sand at 6:2:1 proportion. A bed of 4 m x 3 m will be sufficient for 1.5 kg



of seeds, if sown 1.0 to 1.5 cm apart in rows, with the flat side of the seed towards the soil. A thin layer of soil is spread after sowing and covered with dry straw to a thickness of about 5 cm to ensure uniform temperature and to regulate moisture retention. Sowing is to be taken up in December-January for arabica and in February-March for Robusta. Watering of the seed beds is to be done twice a day in the initial week and thereafter regulated. The seeds sprout in about 40 days when the straw mulch is removed. The primary beds are provided with pandal covered with coir mats or dry leaves.

**Polybag (basket) nursery :** Seedlings from germination beds are transplanted to polythene bags in February-March when they are at the 'button' stage. Polythene bags of 23 cm x 15 cm and 150 gauge thickness with adequate number of holes of 3 mm in the bottom half of the bag are preferred. The bags are filled with prepared mixture of 6 parts of sieved jungle soil, 2 parts of well rotten sieved cattle manure and 1 part of fine sand. The prepared mixture is thoroughly mixed and slightly moistened with water to facilitate packing. The soil is filled into the nursery baskets and pressed firm. Nursery baskets are arranged conveniently in rows of 10 within a rectangular frame with bamboo reapers. These frames are held in positions with bamboo or wooden props driven into the ground at suitable distance.

Coffee seedlings at the button stage are transplanted into nursery baskets. The seedlings are gently lifted from the germination beds with minimum injury to roots. Prior to transplanting, the nursery basket is watered and a vertical hole of 5 cm deep is made in the soil at the centre of the basket. At the time of transplanting it is preferable to slightly nip off the taproot of the seedling. The taproot and the feeder roots should be so disposed as to

enable the plant to strike roots and make firm growth as quickly as possible. The shoot portion of the transplanted seedling should be at the same height above soil level as it was in the germination bed. Transplanting is done preferably in the early morning hours or late in the afternoon. Seedlings uprooted from the primary bed should not be stored for a long time but transplanted immediately.

Regular watering and aftercare of the seedlings should follow. Excess moisture and watering in the afternoon should be avoided as it may induce damping off.

#### Secondary nursery beds

In some areas, seedlings from the germination beds are transplanted to secondary nursery beds of the same soil composition as that of germination beds. Transplanting is done at button stage. Seedlings are planted 30 cm apart. If the taproot is bent or excessively grown, it is nipped off while transplanting. The beds are mulched and watered at regular intervals. Watering should be done during the early morning hours.

#### Aftercare of seedlings

Seedlings are to be manured once in two months with urea dissolved in water or supernatant solution of fermented cowdung slurry. For an area of 1 m<sup>2</sup>, 20 g urea dissolved in 4.5 litres water is sufficient. Adequate protection is given against nursery diseases and pests. Overhead shade in the nursery has to be thinned and finally removed after the onset of monsoon (this is not applicable to northeastern areas). The seedlings grow vigorously if watered judiciously and protected against afternoon sun.

#### Planting in field

Disease free and vigorous seedlings are selected for planting. Seedlings with stunted

and twisted roots are discarded. Rooted plants (aged 16-18 months) with and without ball are planted during June and bag plants are generally planted during September-October. A hole is made at the centre of the pit after levelling the soil. The seedling is placed in the hole with its taproot and lateral roots spread out in proper position. The hole is then filled. The soil around the seedling is packed 3 cm high above the ground to prevent stagnation of water around the collar. The seedlings are provided with cross stakes to prevent wind damage and mulched properly.

Ball and bag seedlings are planted towards the end of the heavy monsoon rains and commencement of northeast rains, i.e., in September. First the bottom portion of the bag is cut and the tip of the root is nipped. The seedling is gently removed from the bag with its soil and root system intact and planted in the hole. The hole is covered with soil and the plant is firmly fixed similar to ball plants. It is wise to maintain both types of nurseries and have planting seasons, June and September.

Planting shade trees\

Dadap is commonly used as a lower canopy shade only in arabicas which require two tier canopy. Stakes of 2 m length are planted for every two plants of coffee. Silver oak and dadap are planted during June when the southwest monsoon commences. During the dry seasons, stems of young dadap are either painted with dilute lime solution or wrapped in agave leaves to protect them from sun scorch.

Clonal propagation

In the case of robusta, which is highly cross pollinated clonal propagation is more adaptable. In the case of arabica, the stabilization of desirable characters in the selected plants could be easily maintained by adopting clonal or vegetative propagation method. The vertical

(orthotropic) shoots are marked after harvest is over in any selected plant. Single node green wood (semi-hardwood) cutting of 10 cm length and three to six months old are planted in polythene bags with the medium of jungle soil, sand and cattle manure in the proportion of 6:3:1. The bags with cuttings are arranged in a propagation chamber made of a trench of size 2 m x 1 m x 0.5 m covered over with a thick polythene sheet (500 gauge) spread over a framework of bamboos.

A trench could accommodate about 108 filled up bags of size 22 cm x 15 cm. Preplanting treatment of the base of cutting with IBA (indole butyric acid) at 5000 ppm enhances early rooting. Under South Indian conditions, cuttings collected during June-July recorded the highest per cent of rooting. Cuttings will root in 3-4 months after planting. Rooted cuttings should be hardened by keeping them under shade for about two months and then can be transplanted into the field.

Manuring

The recommended doses of fertilizers for coffee ( $\text{kg ha}^{-1}$ ) are furnished in Tables 29 & 30.

After cultivation

Grass and other weeds should be eradicated in the first year itself by digging or using appropriate weedicide depending on the nature of the weeds. The soil around the seedlings should be mulched properly and shade has to be provided to individual seedlings to protect against direct sun.

Training and pruning

The plant is trained either on single stem or multiple stem system. Under South Indian conditions periodical handling and pruning are essential. The type and frequency of pruning have to be decided based on a number of factors like the type of vegetative growth,

Table 29. Fertilizer dosage for young coffee plants (in grams per plant/year) and the quantity of straight & complex fertilizers (in grams)

Variety & age of Plant	NPK dose (gram/plant/year)	Combination - A			Combination - B			Combination - B			Complex	Complex
		Urea	R.P 20%	MOP	Urea	R.P 30%	MOP	Urea	DAP	MOP	17:17:17	19:19:19
ARABICA												
1 Year	20:10:20	43	50	33	43	33	33	35	22	33	117	100
2 Year	20:10:20	43	50	33	43	33	33	35	22	33	117	100
3 Year	25:15:25	54	75	42	54	50	42	41	33	42	147	130
4 Year	25:15:25	54	75	42	54	50	42	41	33	42	147	130
ROBUSTA												
1 Year	38:28:38	83	140	63	83	93	63	59	61	63	223	200
2 Year	38:28:38	83	140	63	83	93	63	59	61	63	223	200
3 Year	38:28:38	83	140	63	83	93	63	59	61	63	223	200
4 Year	40:30:40	87	150	67	87	100	67	61	65	67	235	210

Note: RP - Rock Phosphate DAP - Di-ammonium Phosphate MOP - Muriate of Potash

Table 30. Recommended dose of N:P:K fertilizers (kg/year) at different levels of yield and the quantity of straight fertilizers (in kgs) for yielding coffee plants

Sl.No. level	Yield dose (Kgs)	Suggested (NPK kg)	Combination - A			Combination - B			Combination - C		
			Urea	RP 16%	MOP	Urea	RP 30%	MOP	Urea	RP	MOP
1	100	30:27:30	65	135	50	65	90	50	43	58	50
2	200	40:34:40	87	170	66	87	113	66	58	73	66
3	300	50:41:50	114	205	83	114	136	83	73	88	83
4	400	60:48:60	142	240	100	172	160	100	88	103	100
5	500	70:55:70	170	275	116	170	183	116	104	119	116
6	600	80:62:80	198	310	133	198	206	133	119	135	133
7	700	90:69:90	225	345	150	225	230	150	134	149	150
8	800	100:76:100	253	380	166	253	253	166	149	164	166
9	900	110:83:120	281	415	183	281	276	183	164	179	183
10	1000	120:90:120	308	450	200	308	300	200	180	196	200

Note: The suggested dose may be applied in minimum of 2-3 splits or as many splits as possible. In addition to the suggested dosage, 50 kg Urea per acre may be broadcasted during break in monsoon to combat fruit drop due to soil saturation.

incidence of pests / diseases, pattern of blossom showers etc. Centering and desuckering are to be carried out for about 5 or 6 years after planting. Removal of the dead and whippy wood is essential during the early years. Mature plants may require medium to severe pruning once in four years.

Usually coffee, both arabica and robusta, is trained on single stem. When the plants reach a desired height of 75 cm for arabica and 105-120 cm for robusta, they are topped i.e., growing apex of the stem is severed. Low topping (60-70 cm) is advocated in areas of severe wind and exposure. Under certain circumstances, multiple stem system is also adopted as in the case of replanted fields or when under-planting is taken up keeping the old plants under multiple stem system.

#### Irrigation

Wherever water is available, overhead irrigation by sprinkler system is adopted to a greater advantage during November-January to keep the soil moisture level and in February-April for ensuring blossom as well as backing, if necessary.

#### Drought management in coffee

Plants affected by drought limit vegetative growth, show floral abnormalities and poor fruit set resulting in reduced yield. Therefore, drought tolerance is an important aspect of coffee productivity. Arabica coffee is more tolerant to drought than robusta. For inducing tolerance in robusta the following nutrient solution can be sprayed @ 1 litre per plant.

##### Nutrient in 200 litres of water

Urea	1 kg
Super phosphate	1 kg
Muriate of potash	750 g
Zinc sulphate	1 kg

#### Spraying schedule

1<sup>st</sup> spray: 45 days after the last rainfall (usually the 2<sup>nd</sup> fortnight of January)

2<sup>nd</sup> spray: 30-45 days after the first spray

Foliar application of anti-transpirants like Ralli Dhan 110 @ 200 ml in 200 litres of water (0.1 per cent) is also useful for drought management in coffee.

#### Fruit drop

During the developmental stage of berry, 10 to 50 per cent premature fruit drop occurs due to insufficient carbohydrate, auxin-carbohydrate imbalance, nutritional disorders and waterlogging. Many growth regulators have been tried to increase the fruit set and for controlling the pre-mature fruit drop. Following growth regulators could increase the yield when they are given as foliar application 10-15 days after blossom (first spray) and during last week of May before the onset of southwest monsoon (second spray).

#### Fruit ripening

Hastening of fruit ripening in coffee could be achieved by spraying ethephon (Ethrel) on mature berries when 10 per cent natural ripening is observed. By this, ripening can be hastened by 2-4 weeks and in two rounds about

Growth regulators	In 200 ml of water	Dose/ha (for 1.5l)
Planofix	50 ml	375 ml
Homonol	50 ml	375 ml
Agrona	50 ml	375 ml
Miraculan	50 ml	375 ml
Atonik	50 ml	375 ml
Cytozyme crop	60 ml	450 ml
Ascorbic acid	20 g	150 g

96 per cent ripe fruits could be harvested. The following concentrations are standardized for arabica and robusta plants.

Arabica : 100 to 120 ml per 200 litres of water per 400 plants

Robusta: 40 to 54 ml per 200 litres of water per 267 plants

Lower concentrations are to be used in lower elevations and thin shaded places, whereas higher concentrations are to be used in higher elevation and thick shaded plantations.

#### Dieback

Dieback refers to death of younger tertiary branches starting from apex progressing downwards as well as dieback from below the tip of branches and proceeding forward and backward from the point of defoliation. The occurrence of dieback is mainly due to adverse climatic and edaphic factors such as higher temperature, higher light intensity and low moisture status of soil.

#### Management

1. Removal of dead and whippy wood
2. Providing judicious shade by both temporary and permanent shade trees as 70 per cent of daylight is found to be optimum
3. Conservation of soil moisture with thick mulch
4. Foliar application of nutrients
5. Correcting the soil acidity by application of lime

#### Shade and shade management

Dadap (*Erythrina lithosperma*) is generally used as a lower canopy in India. It is always planted along with coffee in new clearings. When stakes are planted in June they grow quickly since sufficient moisture will be there in the soil. In areas where the

establishment of dadap is difficult due to poor rooting, application of rooting hormones and manuring have been found useful.

#### Diseases

##### Leaf rust (*Hemileia vastatrix*)

This is an important disease causing economic loss particularly in arabica coffee. On the lower surface of the infected leaves, small pale yellowish spots appear early after the first rains in the season. These spots soon increase in size and number, and many such spots coalesce at severity causing premature defoliation. Severe defoliation leads to debilitation of the bushes and results in poor cropping in the succeeding seasons.

#### Management

- a. Spraying of Bordeaux mixture 0.5% before the onset of south west monsoon and during post monsoon.
- b. Systemic fungicides, Triadimefon (Bayleton 25 WP) at 160 g per 200 l of water), Hexaconazole (Contaf 5% EC) at 400 ml per 200 l of water are recommended as alternatives to Bordeaux spray.

Bordeaux mixture 0.5 per cent in February-March as pre or post-blossom spray, Oxycarboxin 20 EC 0.03 per cent ai in May-June as pre-monsoon spray, Oxycarboxin 20 EC 0.03 per cent ai or Bordeaux mixture 0.5 per cent in July-August in mid-monsoon spray (if incidence of leaf rust is severe), and Oxycarboxin 20% EC 0.03 per cent ai or Bordeaux mixture 0.5 per cent in September-October as post-monsoon spray.

##### Black rot (*Koleroga noxia*)

A disease more in occurrence in endemic areas with heavy rainfall, saturated atmosphere with 95-100 per cent RH, thick overhead shade, low over-hanging branches, sheltered from sunlight and wind in valleys or continuous

mist during monsoon. The affected bushes have blackening and rotting of leaves, twigs and developing berries. There will be defoliation and berry drop in the affected branches. The entire block affected looks totally debilitated with heavy damage to crop.

#### Management

Centering and handling of the bushes prior to the onset of monsoon and protecting endemic patches with spraying Bordeaux mixture 1 per cent. If incidence is observed during the monsoon, remove the affected twigs and burn them.

- a. In endemic areas spray 1% Bordeaux mixture on both the surfaces of leaves and also to the developing berries just before the onset of monsoon.
- b. If disease is noticed, remove and destroy the affected leaves and berries along with strands of mycelia to prevent further spread.
- c. Spray Carbendazim 0.03% (Bavistin at 120g/200 l of water in black rot affected areas during break in the monsoon.

#### Pests

##### Coffee berry borer

(*Hypothenemus hampei*)

Coffee berry borer is the most serious pest of coffee world over. The female beetle bores into the berries through the navel region and makes tunnels in the hard bean and lays about 15 eggs. The larvae feed on the beans, making small tunnels. A typical pinhole at the tip of the berries indicates the presence of the pest and it damages young as well as ripe berries. In case of severe infestation, 30 to 80 per cent berries may be affected resulting in heavy crop loss. The coffee berry borer can be controlled by the following methods.

#### Management

1. Timely and complete harvest, collection of gleanings, burying the infested berries and maintaining optimum shade and good drainage can control the pest.
2. Timely & clean harvest using picking mat and phytosanitary measures like removal of left over berries on the plant and gleanings (berries fallen on the ground) are the most effective measures to contain the CBB.
3. Release of parasitoid *C. stephanoderis* and application of entomopathogen *B. bassiana* and installing Broca traps @ 60 nos. per ha. for mass trapping are more effective in containing the pest.
4. Although a number of pesticides have been tried against this pest, only a few are effective. Pesticides should be used with extreme caution and only if no other option is available.

For spot sprays, Chloropyrifos 20 EC at 600 ml in 200 l of water along with 200 ml of any wetting agent may be used at the right time i.e. 120 to 150 days after blossom. (Aug-Sept for Arabica and Sept-Oct for robusta) can control the pest.

##### White stem borer

(*Xylotrechus quadripes*)

The adults have two flight periods as they emerge from the pupae during April-May and in September to December/January. As the beetles are active and females lay eggs in the crevices on the main stem of coffee.

1. Tracing, collar pruning/uprooting the infested plants and burn prior to flight periods i.e. before the end of March & September every year. If the uprooted stems are intended for fuel purpose, then such stems should be immersed under water for at least 10 days.

2. Spraying of Chloropyrifos 20 EC at 600 ml in 200 lit of water along with 200 ml wetting agent on the main stem and thick primaries during early part of flight period; April and October every year.
3. In hot spot areas; in open patches and estate borders with badly managed estates adopt bark scrubbling or 10% lime coating or stem wrapping with 5" wide strips cut from fertilizer bags after removing the affected plants by tracing.

Apart from this, it is necessary to build up good shade and regularly trace, uproot stump and burn the infested plants. Storing of cut stems is not advisable, as it will advance the flight period.

#### Shot hole borer (*Xylosandrus compactus*)

This is a major pest in robusta coffee affecting the secondary and tertiary branches causing considerable damage. Injury to the coffee plants is primarily by the extensive tunneling within the branches, which limits the flow of sap. The affected branches dry up. The presence of withering and dead branches with shot holes is the symptom of attack.

#### Management

1. Prune the affected twigs 5-8 cm beyond the shot hole and burn. This operation should commence from September onwards, as soon as the first symptom of attack like dropping of leaves is noticed and continued as a routine measure at regular intervals.
2. The pest prefers to breed in the suckers during dry period. So remove and destroy all the unwanted/infested suckers during summer.

#### Mealy bugs (*Planococcus* sp.)

Mealy bugs damage coffee plants by sucking the sap from the tender branches, nodes, leaves, spikes, berries and roots leading to the debilitation of the plant. In case of root infestation, plants (especially young) become weak, leading to death.

#### Management

1. Release natural enemies like the parasitoid *Leptomastix dactylopii* against *Planococcus citri* or the predator, ladybird beetle, *Cryptolaemus montro-uxieri* against all species of mealybugs.
2. Control ants by dusting Quinalphos 1.5% or Methyl parathion 2% or Malathion 5% dust around the base of the plant.
3. Spray the affected patches with 2% Kerosene emulsion (4l of kerosene in 200 l of water along with 200 ml of any wetting agent). Care should be taken to emulsify kerosene thoroughly.
4. Quinalphos 25 EC at 300 ml in 200 l of water with 200 ml wetting agent can be used as spot spray.
5. If the root is affected, drench the root zone with Dimethoate at 0.09% a.i. (600ml in 200 l of water).

#### Green scale (*Coccus viridis*)

The green scale is a serious sucking pest of coffee particularly arabica.

#### Management

The chemical control measures include spraying the affected patches with any one of the following insecticides viz. cythion 50 EC @ 200 ml, quinalphos 25 EC @ 120 ml or dimethoate 30 EC @ 170 ml.

(Source: Central Coffee Research Institute, Balehonnur, Chikmangalur Dt., Kamataka).

## TEA (*Camellia sinensis*)

Tea grows best in areas with a maximum temperature of 16-32 °C and a well distributed rainfall of about 150 cm per annum. Relative humidity should be around 80 per cent most of the time and should never be less than 40 per cent. The area should not be prone to frost. The soil should be acidic (around pH 5.0) having good drainage facility.

### Varieties

Clones : UPASI-2, UPASI-8, UPASI-9, UPASI-17, TRI-2025, TRF-1

Seedlings : BSS-1, BSS-2

### Propagation

The seed viability extends up to 6 months. Before sowing, seeds are put in water and only the sinkers will be used and floaters rejected. Seeds germinate in 4-6 weeks and the cracked seeds are transplanted in polythene sleeves. The plants will be ready for planting in the main field in nine months.

### Manuring of nursery plants

Composition of tea nursery mixture is as follows:

Ammonium phosphate (20:20)	60 parts
Potassium sulphate	24 parts
(or) Muriate of potash	20 parts
Magnesium sulphate	16 parts

Stock solution Dissolve 30 g of the mixture in 10 litres of water. This can be sprayed over 2 m<sup>2</sup> (450 plants) at weekly interval.

### Field preparation

In the case of new planting, in order to avoid the incidence of root diseases, after felling the trees, remove the root system to the extent possible. Clear the jungle growth but do not burn, the ash being alkaline will increase the pH.

In the case of replanting, remove old *Grevillea* (silveroak) after ring barking, leaving the young ones in the field. Level the land into an even slope to facilitate easy cultural operations and proper drainage.

### Style of planting

Up and down : 1.2 m x 1.2 m (6800 plants ha<sup>-1</sup>)

Contour planting, single hedge: 1.2 m x 0.75 m (10,800 plants ha<sup>-1</sup>)

Contour planting, double hedge: 1.35 m x 0.75 m x 0.75 m (13200 plants ha<sup>-1</sup>)

The double hedge planting will accommodate more number of plants per unit area. Early high yield, better soil conservation, less weed growth, efficient cultural practices and better supervision are other advantages of double hedge planting.

### Pitting

Pits of size 30 cm x 45 cm are taken. Keep the top and bottom soil separately. In clayey soil and drought-prone areas, deeper pits (60 cm) or trench planting will be advantageous.

### Planting seasons

Southwest monsoon areas: June-July  
Northeast monsoon areas: September-October

### Planting

If the soil pH is more than 5.5, apply 100 g of powdered aluminium sulphate per pit and thoroughly mix with soil. Select seedlings of 12 months old. After planting the seedling, compact the soil surrounding the plant and apply mulch @ 25 t ha<sup>-1</sup>. While mulching



care should be taken to keep the mulch material away from the collar region of the plant by putting a peg above the plant on the slope. Wherever mulch material is a problem, intercrop or cover crop could be raised.

### Manuring

Manuring of young tea commences two months after planting. The ratio and source of nutrients vary according to soil reaction (pH).

Rates of fertilizer application for young tea in soils with pH below 4.5 are given below:

Age	N:K <sub>2</sub> O:MgO kg/ha/annum	No. of splits
1 <sup>st</sup> year	180:270:30	5
2 <sup>nd</sup> year	240:360:40	6
3 <sup>rd</sup> year	300:450:50	6
4 <sup>th</sup> year & above	300:300:50	6

Apply phosphorus at 90 kg ha<sup>-1</sup> every year in one application. The quantity of fertilizer per bush may be calculated assuming a population of 13,000 per ha.

Rates of application for soils with pH between 4.5 and 5.5 are as follows:

Age	N:K <sub>2</sub> O kg/ha/annum	No. of splits
1 <sup>st</sup> year	180:270	5
2 <sup>nd</sup> year	240:360	6
3 <sup>rd</sup> year	340:450	6
4 <sup>th</sup> year & above	300:300	6

Apply phosphorus at 90 kg ha<sup>-1</sup> every year in one application.

Rates of application for soils with pH above 5.5 are as follows (use water soluble P):

The rate of fertilizer application for

mature tea varies with yield and soil test values while the N:K<sub>2</sub>O ratio varies with the stage of pruning.

Age	N:P <sub>2</sub> O <sub>5</sub> :K <sub>2</sub> O kg/ha/annum	No. of splits
1 <sup>st</sup> year	180:60:180	5
2 <sup>nd</sup> year	240:80:240	6
3 <sup>rd</sup> year onwards up to 1 <sup>st</sup> pruning	300:100:300	6

### Method of application

Apply the recommended quantity of mixtures along the drip circle of plants. In the semi-circular furrow taken above the plant on the slope, using a Kokra-eyebrow method, apply the fertilizers when there is adequate soil moisture and when the fields are free from weeds. Punch holes of 15-22 cm depth in the soil on either side of the plants and place the rock phosphate.

### Training of young tea

Proper training of young tea is essential to encourage good spread of the bushes, proper development of frames and high density of plucking points.

### Centering

Cut the leader stem of the plants with secateur to arrest the apical dominance and to induce the secondary branches. Cut as low as possible leaving 8-10 mature leaves below the cut. Ensure proper recovery. Centering should be done 4-6 months after planting during humid weather when there is adequate moisture in the soil.

### Tipping

First plucking of the periodic shoot is done after centering / pruning. Two-tier tipping

ensures proper spread. First tipping at 35 cm height will induce the tertiaries. Second tipping at 50 cm height will increase the density of plucking points. Tipping should be done at green, semi-hardwood branches. Tipping should be done in shoots having 3-4 leaves and a bud.

#### Plucking

Mother leaf / step-up plucking is practiced during lean seasons. Level plucking is done during high cropping months. This is essential for better frame development.

#### Shade management

The best permanent shade tree for tea plantation in South India is silver oak (*Grevillea robusta*).

#### Planting of silver oak

The silver oak can be propagated through seeds. The seeds should be sown within six months after collection. Seed should be sown in raised beds of 1 m width and of convenient length using sandy loam soil with a pH around 6.0. Seed should be covered with thin layer of sand / ash. Germination takes place in 2-3 weeks. Use 6-9 month old seedlings for planting. Plant along tea rows at a spacing of 6 m x 6 m (275 plants/ha). Apply a mixture of 100 g rock phosphate and 400 g dolomite per pit and thoroughly mix with soil prior to planting. Apply NK mixture @ 100 g/tree twice in a year; rock phosphate at 250 g/tree and borated lime 1.1 kg (1 kg dolomite + 100 g boric acid) during alternate years.

#### Shade regulation

Tea requires only sparse shade. So retain optimum stand of shade based on the growth of the tree, altitude of the garden and aspect of the field (south and west slopes require more shade). Thin out shade initially to 12 m x 6 m after 8-10 years of planting and if

required further thinning may be done to 12 m x 12 m at later stages (12 years from planting). Always thin out shade prior to pruning.

#### Pollarding

Cutting the main stem with the objective of developing lateral branches is pollarding. Commence pollarding when the trees attain a girth of around 50 cm at elbow level. Pollarding depends on altitude (8 m height for higher altitude, 9 m for low elevation). Leave one branch in each direction and 3 to four tiers of branches, below the pollarding height.

#### Annual lopping

Cutting the erect growing branches on the laterals is lopping, which should be done before the onset of monsoon and lop only the erect branches and retain the laterals.

#### Shade removal

Potential age of *Grevillea* is 40-60 years. Remove old trees after establishing new shade.

#### Temporary shade

For frost prone areas: *Acacia mearnsii*  
For mid elevations: *Indigofera teysmanii*  
For higher altitude: *Sesbania cinerescens*,  
*Crotalaria agathiflora* and *Acacia elata*

Planting at 3 m x 3 m spacing is adopted. Temporary shade should be removed after establishment of *Grevillea* after 3 years.

#### Plucking

##### Ten commandments for plucking

1. Harvest two to three leaves and a bud and / single and two-leaf banjis.
2. Pluck the mother leaf during January-March.
3. Pluck the new level during rest of the month.

4. Pluck at 7-10 days interval during high cropping months.
5. Pluck at 12-15 days interval during low cropping months.
6. Removal of banjis and breaking-back should be a part of plucking operation.
7. Do not pluck below the level.
8. Leave immature shoots.
9. Shear-harvest during rush periods.
10. Cut lanes in older fields.

#### Pruning

Type of pruning	Season	Height
Rejuvenation	April/May	<30 cm
Hard pruning	April/May	30-45 cm
Medium pruning	Aug/Sept	45-60 cm
Light pruning	Aug/Sept	60-65 cm
Skiffing	October	>65 cm

#### Post-pruning care

Apply copper oxychloride or sulphur+linseed oil (1:1) to large cut-ends after rejuvenation and hard pruning.

#### Plant protection

##### Nematodes (*Meloidogyne* spp.)

These microscopic worms infest roots, which develop to knots or galls. Affected roots become defunct and devoid of lateral roots. Plants exhibit chlorosis and stunted growth.

##### Management

##### Nursery

Heat treatment: Spread soil sand mixture (5 cm thick) on a G.I. sheet. Heat it from below. Sprinkle water periodically. Mix the soil thoroughly by turning. Optimum temperature is 60-65°C. Soil should not be too hot to hold in the hand. Over heating of soil will lead to manganese toxicity.

##### Mature tea

Neem cake 2 kg per bush is recommended.

##### White/cockchafer grubs (*Holotrichia* sp.)

The creamy white grub eats away the roots. The main symptoms are ring barking of stem, chlorosis and defoliation. The pest is a serious problem in areas where un-decomposed farm-yard manure is used.

##### Management

Nursery : Heat treatment of soil is effective.

New clearing : Drench chlorpyrifos or quinalphos 0.05 per cent.

(1) At the time of planting: 500 ml per pit.

(2) Post-planting treatment: Loosen the soil around the bush and pour one litre per bush.

##### Root mealy bug (*Dysmicoccus* sp.)

The pest is a problem in the nursery. It sucks sap from the callusing region, mother leaf petiole and axillary buds. This arrests root development; leads to mother-leaf fall and finally death of plant. It can be controlled by spraying and soil drenching with chlorpyrifos or quinalphos 0.05 per cent.

##### Stem borers

##### Red coffee borer (*Zeuzera coffeae*)

Mostly seen in new clearings as batches. Young stems are bored and larvae tunnel downward, make holes at intervals to eject excreta and wood particles. Frass and excreta are seen around plants. Alternate host of the pest is coffee and cocoa.

##### Large hepialid borer

##### (*Sahyadrassus malabaricus*)

This is a polyphagous pest attacking teak, eucalyptus and lantana. Thick branches (3 cm diameter) are preferred by the pest. Callus tissue and wood form food for

larvae. Entrance holes are covered with frassy mat formed with chewed wood and silk.

#### Management

Cut the affected stem and pour quinalphos using ink filler. The holes are plugged with clay paste.

#### Mites

Several species of mites attack tea plants. They are dry weather pests mostly attacking mature foliage except pink and yellow mites.

#### Management

If infestation is more, quinalphos will be effective.

#### Thrips (*Scirtothrips bispinosus*)

This is a major pest in all tea growing countries. Feeding causes lacerations of tissue and appears as streaks. Leaf surface becomes uneven, curled and matty. Feeding marks in bud appear as parallel lines on either side of mid-rib when leaf unfolds. Leaf margins turn yellow.

#### Management

Phosalone, quinalphos and dimethoate can be used for the pest control.

#### Tea mosquito bug (*Helopeltis theivora*)

Adults and nymphs suck the sap from buds, young leaves and tender stems. Due to intensive feeding, leaves curl up, badly deform and shoots dry up. Chemical control involves spraying quinalphos + dichlorvos at spray intervals depending on the intensity of incidence.

#### Root diseases

##### Black root disease (*Rosellinia arcuata*)

Common in areas, which were previously under jungles. The common symptoms are

wilting, chlorosis, drying without defoliation and death of bush.

#### Management

Remove surface mulches around 10 metres. Drench soil with mancozeb 30 g per 10 litres of water. Follow phytosanitary measures. Biocontrol agents *Trichoderma* or *Gliocladium* (200 g per pit) may be incorporated at the time of planting.

Other root diseases are red root disease (*Poria hypolateritia*), brown root disease (*Fomes noxius*), root splitting disease (*Armillaria mellea*) and xylaria root disease (*Xylaria* sp.). Phytosanitary measures, use of biocontrol agents and chemical control (drench soil with tridemorph or hexaconazole 0.5 per cent) are recommended.

#### Stem diseases

##### Collar canker (*Phomopsis theae*)

Seen mostly on young tea. The pathogen invades stem mostly through open wound. The predisposing factors for the disease are deep planting, planting in gravelly soils, mulching closer to collar, wounds caused by weeding implements, fertilizer application close to collar, pegging, low moisture status in bark and surface watering during dry weather. The main symptoms are chlorosis, cessation of growth, profuse flowering and canker on stem.

#### Management

Remove affected portion by pruning the healthy wood and apply copper fungicide to cut ends.

Other stem diseases are branch canker (*Macrophoma theicola*), woodrot (*Hypo-xylon serpens*) and dieback (*Leptothyrium theae*).

**Leaf disease****Blister blight (*Exobasidium vexans*)**

The fungus affects only tender leaves and stems (pluckable shoots). Translucent spots occur in three to ten days and well developed lesions are seen in two weeks. Lesions are sunken on the upper surface and convex at lower surface. Affected leaves are distorted and irregularly rolled. Stem

infection leads to goose-neck shape, dieback and snapping at the point of infection.

**Management**

Copper oxychloride 350 g + plantamycin 70 g per ha at 3 to 4 days interval can control the disease.

(Source: UPASI Tea Research Foundation, Coonoor)

## TOBACCO (*Nicotiana tabacum*)

Tobacco is generally raised as a cold weather crop, the optimum temperature range being 18 to 27°C. The crop prefers well-drained fertile soil. Acidic soils are also suitable. It is sensitive to waterlogging.

**Season**

October-February

**Seeds and sowing**

Raised nursery beds of 1 m width and of convenient length should be prepared for raising seedlings. The beds should be manured with well rotten FYM @ 1 kg/m<sup>2</sup>. About 75 g seeds sown over an area of 100 m<sup>2</sup> will give the required number of seedlings for planting one hectare. Seeds may be mixed with fine sand or ash @ 1:15 by weight and broadcasted. It is covered by raking or by brushing. Watering may be done using rose-can. It is desirable to apply 1 kg of ammonium sulphate per 100 m<sup>2</sup> of nursery in liquid form and the application is repeated at tri-weekly intervals. Seedlings will be kept in the nursery for about 8-10 weeks. Pandal may be provided for shade.

**Main field planting**

Seedlings are transplanted on flat beds. The nursery is irrigated well a day before planting to facilitate easy pulling out of the seedlings. Seedlings are planted 10-15 cm deep in the main field at a spacing of 85 cm x 85 cm.

**Manuring**

Cattle manure @ 5-10 t ha<sup>-1</sup> for cigarette tobacco and 50-60 t ha<sup>-1</sup> for hookah tobacco may be applied as basal dose. Apply fertilizers (kg ha<sup>-1</sup>) as shown below:

Tobacco	N	P <sub>2</sub> O <sub>5</sub>	K <sub>2</sub> O
Cigarette tobacco	100	50	100
Cigar tobacco	75	50	100
Beedi tobacco	100	50	100
Cheroot tobacco	50	50	100
Chewing tobacco	75-100	50	100

**After cultivation**

The first intercultivation may be done 12-15 days after transplanting. Thereafter,

three hoeings are to be given at fortnightly intervals. Keep the field free of weeds. Irrigate as and when necessary.

#### Topping and de-suckering

Remove the terminal bud at the time of flowering. In the case of chewing tobacco, the number of leaves to be maintained varies from 8-15. Remove the suckers as and when produced.

#### Harvesting

Harvesting is done either by removing the mature leaves or by cutting the stalk when maximum leaves are matured. The harvested leaves are cured for the purpose for which the produce is meant.

#### Plant protection

Important pests and diseases of tobacco and their control measures are given below:

##### Stem borer (*Phthorimoea* spp.)

Use healthy seedlings for planting.

##### Tobacco caterpillar (*Spodoptera litura*)

1. Destroy egg masses and groups of caterpillars found on the leaves.
2. Prevent oviposition on nursery plants by covering the beds at night with gunny sheets.

##### Bacterial wilt

1. Use resistant / tolerant varieties.
2. Rotate with resistant crops.
3. Do not let in irrigation water or drainage water from infested fields.
4. Discard all seedlings from infested nursery.

##### Damping off

1. Drench the nursery bed with cheshunt compound solution 3-4 days before sowing.
2. Spray the seedlings with mancozeb 0.3 per cent

##### Powdery mildew

Dust sulphur at 45 kg ha<sup>-1</sup>. Before dusting mix sulphur with sand or ash.

## VEGETABLES

Under this chapter, package of practices for amaranth, okra, cucurbitaceous vegetables, solanaceous vegetables, cool season vegetables and minor vegetables are furnished. A separate table showing the waiting period for insecticides on vegetables has been included. Con-

trol of pests of vegetables with the help of non-chemical insecticides and tips for vegetable seed production are also given under separate titles. Certain recommendations given under the non-chemical control of pests have not been included under the respective crops to avoid repetition.

### AMARANTH (*Amaranthus* spp.)

Amaranth is the most popular leafy vegetable of Kerala. It can be grown throughout the year. Avoid sowing or planting of red leaved varieties during periods of heavy rain.

#### Varieties

Red: Kannara Local, Arun and Krishnasree.

Green: Co-1, Co-2, Co-3, Mohini and Renusree

Note : Kannara Local is a season bound variety, which comes to flowering in November-December.

Seed rate: 1.5 to 2.0 kg ha<sup>1</sup>

#### Preparation of land

Prepare the land by ploughing or digging followed by levelling. Then shallow trenches of width 30-35 cm are made 30 cm apart. Well rotten FYM is mixed with soil in the trenches. Transplant 20-30 day old seedlings in the shallow trenches at a distance of 20 cm in two rows. During rainy season planting shall be done on raised beds.

#### Manuring

Apply 50 tonnes of FYM per ha as basal dose before planting fertilizer recommendation

is 100:50:50 kg ha<sup>1</sup>. After preparing trenches, apply N:P<sub>2</sub>O<sub>5</sub>:K<sub>2</sub>O @ 50:50:50 kg ha<sup>1</sup>. Another 50 kg of N can be applied at regular intervals as top dressing. Spraying 1 per cent urea immediately after each harvest will increase the yield.

#### Plant protection

As far as possible, avoid use of insecticides or fungicides. In severe cases of leaf webber attack, spray malathion 0.1 per cent or dust malathion 10 per cent DP.

#### Diseases

For controlling leaf blight following practices are recommended

1. *Pseudomonas fluorescens* - 2% (foliar spray + *Trichoderma viride* - 2% (soil application)
2. Turmeric powder + baking soda mixture (5:1 ratio/litre) (foliar spray and soil drenching).
3. Cow dung slurry supernatant 2% + *Pseudomonas fluorescens* 2% (foliar spray and soil drenching).

## OKRA (*Abelmoschus esculentus*)

The three main planting seasons for Okra are February-March, June-July and October-November.

### Varieties

Green / light green fruited: Pusa Sawani, Pusa Makhmali, IARI Selection 2, Kiran, Salkeerthi.

Red fruited: Co-1, Aruna

Yellow vein mosaic resistant/tolerant: Arka Anamika, Arka Abhay, Susthira, Anjitha, Manjima (all green fruited).

### Seed rate

The seed rate is 8.5 kg ha<sup>-1</sup> for the summer crop sown in February-March and 7 kg ha<sup>-1</sup> for kharif crop.

### Storage of seeds

Packing of okra seeds in polythene cover (700 gauge) increases the storage life upto 7 months.

### Planting

For kharif crop, sow the seeds at a spacing of 60 cm between rows and 45 cm between plants. For the summer crop, soak the seeds in water for 24 hours before sowing and give a spacing of 60 cm x 30 cm.

### Manuring

Apply FYM @ 20 t ha<sup>-1</sup> as basal dose. At the time of sowing apply N, P<sub>2</sub>O<sub>5</sub> and K<sub>2</sub>O @ 55, 35 and 70 kg ha<sup>-1</sup>. Another 55 kg N ha<sup>-1</sup> may be applied one month after sowing.

Note: For reclaimed soils of Kuttanad, a fertilizer dose of N:P<sub>2</sub>O<sub>5</sub>:K<sub>2</sub>O 75:5:15 kg ha<sup>-1</sup> is recommended.

Apply FYM or compost @ 25t/ha as basal dose. Top dressing with groundnut cake

1 kg/ 10 litre (50 kg ha<sup>-1</sup>) at fortnight intervals upto flowering. Groundnut cake soaked for 3 days and the supernatant solution serve as the spray fluid.

### After cultivation

Give pre-sowing irrigation, if soil is not moist enough. During summer, irrigate at intervals of 2 to 3 days. Conduct weeding regularly and earth up rows during rainy season.

### Plant protection

The important pests are jassids, fruit and shoot borer and root knot nematode.

Against jassids, use quinalphos 0.05 per cent or imidacloprid 17.8% SL 20g ai/ha or thiamethoxam 25% WG 25g ai/ha as foliar sprays. For controlling fruit and shoot borers, remove all drooping shoots and damaged fruits. Spray emamectin benzoate 5% SG @ 10 g ai/ha or chlorantraniliprole 18.5 SC @ 30 g ai/ha at an interval of 15 days.

For the control of nematodes, apply sawdust or paddy husk at 500 g/plant or neem leaves or Eupatorium leaves at 250 g/plant in basins one week prior to planting and water daily. The effect of this treatment persists up to 75 days after sowing in summer season.

For managing root knot nematode, seed treatment with *Bacillus macerans* @ 3 per cent w/w. (2.5kg ha<sup>-1</sup>) and in heavily infested area seed treatment with *B. macerans* @ 3 per cent w/w. and drenching with *B. macerans* @ 3 per cent solution 30 days after sowing can be recommended.

In general, insecticides of plant origin may be used, as far as possible.



### Yellow vein mosaic

This is a common disease in okra, which shows vein clearing and vein chlorosis of leaves. The yellow network of veins is very conspicuous and veins and veinlets are thickened. Fruits become small and yellowish green in colour. White fly (*Bemisia tabaci*) is the vector. Cultivate resistant varieties like Arka Anamika, Arka Abhay and Susthira.

Destruction of weeds (*Croton sparsiflora* and *Ageratum* sp.) is very necessary.

### Cercospora leaf spot

For the management of *Cercospora* leaf spot, foliar spraying of *Trichoderma viride* 2% thrice at fortnightly interval on both surface of leaves on symptoms appearance or *Pseudomonas fluorescens* 2% thrice at 14 days interval.

## CUCURBITACEOUS VEGETABLES

### BITTER GOURD (*Momordica charantia*)

Bitter gourd is an important cucurbitaceous vegetable of Kerala.

#### Season

January-March and September-December are the ideal seasons. For the rainfed crop, sowing can be started after the receipt of first few showers during May-June.

#### Varieties

Priya, Preethi, Priyanka and Arka Harit are high yielding varieties. Priyanka is recommended for acid alluvial soils of Kerala.

Seed rate: 5.0 – 6.0 kg ha<sup>-1</sup>

Soaking seeds in 1:10 solution of 150 ppm Potassium Nitrate for 3 hrs increases germination and seedling vigour.

Spacing: 2.0 m x 2.0 m

#### Sowing

Pits of 60 cm diameter and 30-45 cm depth are taken. Well rotten FYM and fertilizers are mixed with topsoil in the pit and seeds are sown @ 4-5 per pit. Unhealthy plants are removed after two weeks and only 3 plants are retained per pit.

#### Manuring

Fertilizer dose recommended is 70:25:25 Kg ha<sup>-1</sup>. Apply FYM @ 20-25 t ha<sup>-1</sup> as basal dose along with half dose of N (35 kg) and full doses of P<sub>2</sub>O<sub>5</sub> (25 kg) and K<sub>2</sub>O (25 kg). The remaining dose of N (35 kg) can be applied in several split doses at fortnightly intervals.

#### After cultivation

During the initial stages of growth, irrigate at 3-4 days interval and alternate days during flowering/fruiting. Irrigation at 15 mm CPE (approximately at 3 days interval for sandy loam soils) is more economical than irrigating once in two days especially during summer months for water economy. Erect pandals when the plants start vining. Conduct weeding and raking of the soil at the time of fertilizer application. Earthing up is done during rainy season.

#### Pests

##### Fruit fly (*Bacterocera* sp.)

In homestead gardens the fruits may be covered with polythene, cloth or paper bags to ensure mechanical protection. In large gardens apply malathion 0.15 per cent suspension containing sugar or jaggery at 10 g/l at fortnightly intervals at flowering and fruit initiation. Spray as coarse droplets on the ventral surface of leaves. Remove and destroy affected and decayed fruits. It can also be effectively controlled by the use of banana fruit traps coupled with the removal and destruction of infested fruits. It is more efficient than two sprayings with insecticides. Traps are to be set at a distance of 2 m after a border row and they may be replenished after 7 to 9 days. Start bait trapping just before flowering.

#### IPM Package

Collection and destruction of fallen fruits, setting up pheromone traps (cue lure trap) @ one trap per 15 cents, banana jaggery food

bait 100ml (20g banana +10 g jaggery +0.2 ml malathion) mashed in 100ml water, kept in plastic bottles with 3 holes) @ one trap per 8 plants. Also spot application of 10% jaggery containing 0.1% malathion @ 1 spot/40m<sup>2</sup> on the under side of leaves at fortnightly intervals during fruiting season and application of *Beauveria bassiana* @ 10 litres/40m<sup>2</sup> (containing 20 g formulation/litre) in soil during fruiting season is recommended.

#### Epilachna beetle

Remove and destroy egg masses, grubs and adults occurring on leaves.

#### Leaf feeders and sucking pests

Spray 2% talc based formulation of *Beauveria bassiana* + 0.1% teepol at fortnightly intervals for the management of pumpkin caterpillar, leaf footed bugs and plant lice.

#### Plant lice

Apply 1.5 per cent fish oil soap. First dissolve soap in hot water and then make up the volume. Alternatively apply dimethoate 0.05 per cent.

#### Diseases

##### Downy mildew

It is severe during rainy season. This can be checked by spraying mancozeb 0.2 per cent (waiting period of mancozeb is three days).

Foliar sprayings of combination fungicide Cymoxanil +Mancozeb 2 g l<sup>-1</sup> or two sprayings of *Pseudomonas fluorescens* 2% (20 g l<sup>-1</sup>) thrice at fortnightly interval on the appearance of symptoms.

##### Powdery mildew

Can be controlled by spraying Dinocap 1 ml l<sup>-1</sup> or *Trichoderma viride* 2 g l<sup>-1</sup> or neem oil 2% as 3 foliar sprays at 14 days interval on symptom appearance.

##### Mosaic

Control the vectors by spraying dimethoate 0.05 per cent. Uprooting and destruction of affected plants and collateral hosts.

Harvesting can be done only after 10 days (at least) of insecticide/ fungicide application. The fruits should be washed thoroughly in water before cooking.

## SNAKE GOURD (*Trichosanthes anguina*)

Snake gourd is a common cucurbitaceous vegetable of Kerala.

#### Season

January-March and September - December are the main growing seasons.

Varieties : Kaumudi, Baby, Harithasree and Manusree.

Seed rate : 3.0 - 4.0 kg ha<sup>-1</sup>

Spacing : 2.0 m x 2.0 m

#### Sowing

Pits of 60 cm diameter and 30-45 cm depth are taken. Well rotten FYM and fertilizers are mixed with top soil in the pit and seeds are sown @ 4-5 per pit. After two weeks remove the unhealthy plants retaining three plants per pit.

#### Manuring

Fertilizer recommendation is 70:25:25 kg ha<sup>-1</sup>. Apply FYM @ 20-25 kg ha<sup>-1</sup> as basal dose

along with half dose of N (35 kg) and full dose of  $P_2O_5$  (25 kg) and  $K_2O$  (25 kg). The remaining dose of N (35 kg) is applied in several split doses at fortnightly intervals.

#### After cultivation

During the initial stages of growth irrigate at an interval of 3-4 days. Irrigate on alternate days during flowering and fruiting periods.

Erect pandals for trailing snake gourd. Conduct weeding and raking of the soil at the time of fertilizer application.

#### Pests

The important pests attacking snake gourd are fruit flies, epilachna beetle, pumpkin caterpillar, red pumpkin beetle and snake gourd caterpillar. Control measures recommended for fruit flies and epilachna beetle in bitter gourd can be followed in this case also.

#### Red pumpkin beetle

Adult beetle eats the leaves, makes hole on foliage and causes damage on roots and leaves.

#### Leaf feeders and sucking pests

Spray 2% talc based formulation of *Beauveria bassiana* + 0.1% teepol at fortnightly intervals for the management of leaf feeders (snake guard caterpillar, pumpkin caterpillar, pumpkin beetle and leaf footed bugs).

In severe case of infestation of pumpkin caterpillar, apply chlorantraniliprole 18.5 SC @ 30 g ai ha<sup>-1</sup>.

#### Diseases

The important diseases are downy mildew and mosaic. The control measures as stated under bitter gourd can be adopted.

## CUCUMBER (*Cucumis sativus*) & ORIENTAL PICKLING MELON (*Cucumis melo* var. *conomon*)

Cucumber and oriental pickling melon are important cucurbits grown in Kerala. Cucumber is mainly used as a salad crop whereas oriental pickling melon is largely used after cooking.

#### Season

The ideal seasons are January-March and September-December.

#### Varieties

Mudicode, Arunima and Saubhagya are high yielding varieties of oriental pickling melon. Cucumber varieties such as Subhra, Heera, Pusa Sheethal, Poinsette, Poona Khira are exclusively used for salad purpose.

Seed rate: 0.5 - 0.75 kg ha<sup>-1</sup>

Spacing: 2.0 m x 1.5 m

#### Preparation of land

Pits of 60 cm diameter and 30-45 cm depth are taken. Well rotten FYM and fertilizers are mixed with topsoil in the pit and four or five seeds are sown in a pit. Remove unhealthy plants after two weeks and retain three plants per pit.

#### Manuring

Apply FYM @ 20-25 t ha<sup>-1</sup> as basal dose along with half dose of N (35 kg) and full dose of  $P_2O_5$  (25 kg) and  $K_2O$  (25 kg ha<sup>-1</sup>). The

remaining dose of N (35 kg) can be applied in two equal split doses at the time of vining and at the time of full blooming. A fertilizer dose of 70:25:25 kg N:P<sub>2</sub>O<sub>5</sub>:K<sub>2</sub>O/ha in several splits is recommended in Onattukara region. The fertilizer dose per pit would be 28:10:10 g N:P<sub>2</sub>O<sub>5</sub>:K<sub>2</sub>O.

#### After cultivation

During the initial stages of growth, irrigate at an interval of 3-4 days. Irrigate in alternate days, during flowering and fruiting. For trailing cucumber and melon, spread dried twigs on the ground. Conduct weeding and raking of the soil at the time of fertilizer

application. Earthing up may be done during rainy season.

#### Pests

The important pests are epilachna beetle and red pumpkin beetle. They can be controlled by adopting the measures recommended for bitter gourd.

#### Diseases

The important diseases are downy mildew, powdery mildew and mosaic. The control measures as recommended for bitter gourd can be adopted.

## WATER MELON (*Citrullus lanatus*)

Season : The ideal season is Dec-April.

Varieties : Sugar Baby, Arka Jyothi

Seedless Varieties : F1-Shonima and F1-Swama

Seed rate : 1 to 1.5 kg ha<sup>-1</sup>

Spacing : 3.0 m x 2.0 m

#### Preparation of land

Pits of 60 cm diameter and 30-45 cm depth are taken. Well rotten FYM and fertilizers are mixed with topsoil in the pit and four or five seeds are sown in a pit. Remove unhealthy plants after two weeks and retain two or three plants per pit.

#### Manuring

Fertilizer recommendation is 70:25:25 kg ha<sup>-1</sup>. Apply FYM @ 20-25 t ha<sup>-1</sup> as basal dose along with half dose of N (35 kg) and full doses of P<sub>2</sub>O<sub>5</sub> (25 kg) and K<sub>2</sub>O (25 kg ha<sup>-1</sup>). The remaining dose of N (35 kg) can be applied in

two equal splits at the time of vining and full blooming.

#### After cultivation

During the initial stages of growth, irrigate at an interval of three or four days. Irrigate on alternate days during flowering and fruiting. When fruits mature, the frequency of irrigation may be reduced. For trailing the water melon, spread dried twigs on the ground. Conduct weeding and raking of the soil at the time of fertilizer application.

#### Pests

The important pests are red pumpkin beetle and epilachna beetle. They can be controlled by adopting measures suggested for bitter gourd.

#### Diseases

Downy mildew and powdery mildew are important diseases affecting water melon. Control them by adopting measures recommended for bitter gourd.

## BOTTLE GOURD (*Lagenaria siceraria*)

### Season

Bottle gourd can be successfully grown during January-March and September-December. For the rainfed crop, sowing can also be started after the receipt of the first few showers during May-June.

### Varieties

Pusa Summer Prolific Long, Arka Bahar

Seed rate: 3 - 4 kg ha<sup>-1</sup>

### Preparation of land

Pits of 60 cm diameter and 30-45 cm depth are taken at 3 m x 3 m spacing for growing on pandals. For trailing on the ground, make pits at a spacing of 2 m in rows 3-4 m apart. Well rotten FYM and fertilizers are mixed with topsoil in the pit.

### Sowing

Four or five seeds are sown per pit. Remove unhealthy plants after two weeks and retain three plants per pit.

### Manuring

Fertilizer recommendation is 70:25:25 kg ha<sup>-1</sup>. Apply FYM @ 20-25 t ha<sup>-1</sup> as basal dose along

with half dose of N (35 kg) and full dose of P<sub>2</sub>O<sub>5</sub> (25 kg ha<sup>-1</sup>) and K<sub>2</sub>O (25 kg ha<sup>-1</sup>). The remaining dose of N (35 kg) can be applied in several split doses at fortnightly intervals.

### After cultivation

During the initial stages of growth, irrigate at an interval of three or four days. Irrigate on alternate days during flowering and fruiting periods. Trailing can be done either on pandals or on the ground.

Conduct weeding and raking of the soil at the time of fertilizer application. Earthing up may be done during rainy season.

### Pests

The important pests are epilachna beetle and red pumpkin beetle. They can be controlled by adopting measures recommended under bitter gourd.

### Diseases

Downy mildew, powdery mildew and mosaic are important diseases in bottle gourd. Refer control measures recommended for bitter gourd.

## PUMPKIN (*Cucurbita moschata*)

### Season

Pumpkin can be successfully grown during January-March and September-December. For the rainfed crop, sowing can also be started after the receipt of the first few showers during May-June.

Varieties : Ambili, Suvama, Saras and Sooraj

Seed rate: 1.0 to 1.5 kg ha<sup>-1</sup>

### Preparation of land

Pits of 60 cm diameter and 30-45 cm depth

are taken at a spacing of 4.5 m x 2.0 m. Well rotten FYM and fertilizers are mixed with topsoil in the pit.

### Sowing

Four or five seeds are sown per pit. Remove unhealthy plants after 2 weeks and retain three plants per pit.

### Manuring

Fertilizer recommendation is 70:25:25 kg ha<sup>-1</sup>. Apply FYM @ 20-25 t ha<sup>-1</sup> as basal dose

along with half dose of N (35 kg) and full dose of  $P_2O_5$  (25 kg) and  $K_2O$  (25 kg ha<sup>-1</sup>). The remaining dose of N (35 kg) can be applied in two equal split doses at the time of vining and at the time of full blooming.

#### After cultivation

During the initial stages of growth, irrigate at an interval of three or four days. Irrigate on alternate days during flowering and fruiting periods. For trailing, spread dried twigs on the ground. Conduct weeding and raking of the soil at the time of fertilizer application.

Earthing up may be done during rainy season.

#### Plant protection

#### Pests

Fruit flies, epilachna beetle and red pumpkin beetle are important pests affecting pumpkin. They can be controlled as in case of bittergourd.

#### Diseases

Downy mildew, powdery mildew and mosaic are important diseases affecting pumpkin.

## ASH GOURD (*Benincasa hispida*)

#### Season

Ash gourd can be successfully grown during January-March and September-December. For rainfed crop, sowing can also be started after the receipt of the first few showers during May-June.

Varieties: KAU Local, Indu and Thara

Seed rate: 0.75-1.0 kg ha<sup>-1</sup>

#### Preparation of land

Pits of 60 cm diameter and 30-45 cm depth are taken at 4.5 m x 2.0 m spacing. Well rotten FYM and fertilizers are mixed with topsoil in the pit.

#### Sowing

Seeds are sown @ four or five per pit. Remove unhealthy plants after two weeks and retain two or three plants per pit.

#### Manuring

Fertilizer recommendation is 70:25:25 kg ha<sup>-1</sup>. Apply FYM @ 20-25 t ha<sup>-1</sup> as basal dose along

with half dose of N (35 kg) and full dose of  $P_2O_5$  (25 kg) and  $K_2O$  (25 kg ha<sup>-1</sup>). The remaining dose of N (35 kg) can be applied in two equal split doses at the time of vining and at the time of full blooming.

#### After cultivation

During the initial stages of growth, irrigate at an interval of three or four days. Irrigate on alternate days during flowering and fruiting. For trailing, spread dried twigs on the ground. Conduct weeding and raking of the soil at the time of fertilizer application. Earthing up may be done during rainy season.

#### Pests

Fruit fly, epilachna beetle and red pumpkin beetle are important pests affecting ash gourd. They can be controlled as given under bitter gourd. Aphids can be controlled by spraying malathion 0.01 per cent or quinalphos 0.05 per cent.

#### Diseases

Powdery mildew, downy mildew and mosaic are important diseases in ash gourd. They can be controlled as in bitter gourd.

## SOLANACEOUS VEGETABLES

Brinjal, chilli and tomato are the important solanaceous fruit vegetables grown in the

state. The cultural operations of the above three crops are similar with only slight variations.

### BRINJAL (*Solanum melongena*)

#### Varieties

Surya, Swetha and Haritha (bacterial wilt resistant open pollinated varieties), Neelima (bacterial wilt resistant  $F_1$  hybrid), Pusa Purple Cluster and Ponny.

Seed rate : 370-500 g ha<sup>-1</sup>

#### Raising seedlings

Brinjal is a transplanted vegetable. Seeds are sown in the nursery and one month old seedlings are transplanted to the main field. For sowing the seeds, raised seed beds of 90 to 100 cm width and convenient length are prepared in open space with fertile topsoil to which well decomposed organic matter has been incorporated. Solarization of nursery beds for 30 days prior to sowing is effective in managing damping off disease. After sowing the seeds, mulch with green leaves and irrigate with a rose-can daily in the morning. Remove the mulch immediately after germination of the seeds. Restrict irrigation one week before transplanting and irrigate heavily on the previous day of transplanting. Protray seedling can also be used.

#### Time of planting

For rainfed crop, transplant the seedlings during May-June before the onset of southwest monsoon. Planting can also be done during September-October for irrigated crop.

#### Land preparation and transplanting

Land is prepared to a fine tilth by thorough ploughing or digging. Well rotten

organic manure is incorporated in the soil and seedlings are transplanted in shallow trenches/pits during May or on ridges/levelled lands during rainy season. Transplanted seedlings may be given temporary shade for 3-4 days during summer.

#### Spacing

Transplant less spreading varieties like Swetha and Surya at 60 cm x 60 cm. For spreading varieties Haritha and Neelima, provide wider spacing of 75-90 cm x 60 cm.

#### Manuring

Apply well rotten FYM / compost @ 20-25 t ha<sup>-1</sup> at the time of land preparation and mix well with the soil. A fertilizer dose of 75:40:25 kg N:P<sub>2</sub>O<sub>5</sub>:K<sub>2</sub>O per ha may be given. Half the dose of nitrogen, full phosphorus and half of potash may be applied as basal dose before transplanting. One fourth of nitrogen and half of potash may be applied 20-30 days after planting. The remaining quantities may be applied two months after planting. Application of 75:25:25 kg N:P<sub>2</sub>O<sub>5</sub>:K<sub>2</sub>O per ha is optimum for getting maximum yield of fruits for the variety Swetha in the reclaimed alluvial soils of Kuttanad. However, the economic optimum dose was found to be 60:20:25 kg of N:P<sub>2</sub>O<sub>5</sub>:K<sub>2</sub>O per ha.

#### After cultivation

Irrigate at three or four days interval during summer. Stake the plants if necessary.



Weeding followed by fertilizer application and earthing up may be done at one and two months after transplanting.

#### Plant protection

For avoiding damping off of the seedlings in the nursery, sow the seeds as thin as possible in the raised beds prepared in the open area during summer months. Soil solarization of nursery beds for 30 days prior to sowing and seed treatment with *Trichoderma* (5 g kg<sup>-1</sup> seed) is effective in managing the disease.

Follow mechanical removal and destruction of pest / disease affected portions for control of fruit and shoot borer and *Phomopsis* fruit rot. Spray emamectin benzoate 5% SG @ 10g ai ha<sup>-1</sup> or chlorantraniliprole 18.5 SC @ 30g ai ha<sup>-1</sup> at an interval of 15 days to control fruit and shoot borer under large scale cultivation.

When infestations of sucking pests like mite, jassids and white fly are severe, spray thiamethoxam 25 WG @ 50 g ai ha<sup>-1</sup> or diafenthiuron 50 WP @ 300 g ai ha<sup>-1</sup> or spiromesifen 22.9 SC @ 96 g ai ha<sup>-1</sup>. Uproot plants affected by little leaf and spray insecticides for further control.

Cultivate resistant varieties like Surya, Swetha and Haritha and the hybrid Neelima in bacterial wilt prone areas. Soil solarization method and *Trichoderma* application is also recommended.

For managing root knot nematode, nursery treatment with *Bacillus macerans*/*Paecilomyces lilacinus* @ 25 g/m<sup>2</sup> and mainfield treatment with *P. lilacinus* @ 5g/m<sup>2</sup> can be recommended.

In general, insecticides of plant origin may be used, as far as possible.

## CHILLI (*Capsicum* spp.)

#### Varieties

High yielding varieties: Jwalasakhi, Jwalamukhi, Jwala, Pant C-1, K-2, Vellayani Athulya, Keerthi, Vellayani Thejus and Vellayani Samrudhi.

Bacterial wilt resistant varieties: Ujwala, Anugraha.

Seed rate: 1.0 kg ha<sup>-1</sup>

#### Raising seedlings

Chilli is a transplanted crop. Seeds are sown in the nursery and one month old seedlings are transplanted to the main field. For sowing the seeds, raised seed beds of 90 to 100 cm width and of convenient length are prepared to which well decomposed organic matter has been incorporated. After sowing the seeds, mulch with green leaves and irrigate with a rosecan daily in the morning.

Remove the mulch immediately after germination of the seeds. Restrict irrigation one week before transplanting and irrigate heavily on the previous day of transplanting. Protray seedlings can also be used.

#### Time of planting

For a rainfed crop, transplant the seedlings during May-June before the onset of south-west monsoon. Planting can also be done during September-October for an irrigated crop.

#### Land preparation and transplanting

Land is prepared to a fine tilth by thorough ploughing / digging. Well rotten organic manure is incorporated in the soil and seedlings are transplanted in shallow trenches / pits during May or on ridges / level

lands during rainy season. Transplanted seedlings may also be given temporary shade for three to four days during summer.

#### Spacing

Transplant less spreading varieties at 45 cm x 45 cm. For spreading cultivars like White Kanthari provide a wider spacing of 75 cm x 45-60 cm.

#### Manuring

Apply well rotten FYM / compost @ 20-25 t ha<sup>-1</sup> at the time of land preparation and mix well with the soil. A fertilizer dose of 75:40:25 kg N:P<sub>2</sub>O<sub>5</sub>: K<sub>2</sub>O per ha may be given. Half of nitrogen, full phosphorus and half of potash may be applied as basal dose before transplanting. One fourth of nitrogen and half of potash may be applied 20-30 days after planting. The remaining quantity may be applied two months after planting.

#### After cultivation

Irrigate at three to four days interval during summer. Stake the plants if necessary. Weeding followed by fertilizer application and earthing up may be done at one and two months after transplanting.

#### Plant protection

Damping off : Soil solarization of nursery beds for 30 days prior to sowing and seed treatment with Trichoderma (5 g kg<sup>-1</sup> seed) is effective in managing the disease.

Uproot and destroy the plants affected by mosaic and bacterial wilt. Cultivate resistant varieties like Ujwala and Anugraha in bacterial wilt prone areas.

Spray quinalphos 0.05 per cent or Dimethoate at 0.05% for managing sucking pests like mealy bugs, lace wing bugs and aphids. Apply spiromesifen 22.9 SC @ 96 g ai ha<sup>-1</sup> or fenpyroximate 5 EC @ 15 g ai ha<sup>-1</sup> against thrips

#### Chilli mite

It is an important sucking pest infesting all stages of plant. Feeding of mite causes downward curling of the leaves and become brittle and tubular. Spray dimethoate at 0.05% or spiromesifen 22.9 SC @ 96 g ai ha<sup>-1</sup> or fenpyroximate 5 EC @ 15 g ai ha<sup>-1</sup>

It can also be managed by the application of neem oil 5 per cent and neem oil+garlic emulsion 2 per cent.

## TOMATO (*Solanum lycopersicum*)

#### Varieties

Bacterial wilt resistant varieties: Sakthi, Mukthi, Anagha and Vellayani Vijai, Manulekshmi and Manuprabha.

Rain shelter variety : Akshaya

Seed rate : 400 g ha<sup>-1</sup>

#### Raising seedlings

Tomato is a transplanted vegetable. Seeds

are sown in the nursery and one month old seedlings are transplanted to the main field. For sowing the seeds, raised seed beds of 90 to 100 cm width and of convenient length are prepared to which well decomposed organic matter has been incorporated. After sowing the seeds, mulch with green leaves and irrigate with a rose-can daily in the morning. Remove the mulch immediately after germination of the seeds. Restrict

irrigation one week before transplanting and irrigate heavily on the previous day of transplanting. Protray seedlings can also be used.

#### Time of planting

Transplant the seedlings during October-November for an irrigated crop.

#### Land preparation and transplanting

Land is prepared to a fine tilth by thorough ploughing or digging. Well rotten organic manure is incorporated in the soil and seedlings are transplanted in shallow trenches / pits / levelled lands. Transplanted seedlings may be given temporary shade for three to four days during hot days.

#### Spacing

Transplant the seedlings at 60 cm x 60 cm

#### Manuring

Apply FYM @ 20 t ha<sup>-1</sup> along with AMF, Pseudomonas, Trichoderma and Azotobacter each @ 5 kg ha<sup>-1</sup> as basal dose and cultivate cowpea as a catch crop in these fields.

A fertilizer dose of 75:40:25 kg N:P<sub>2</sub>O<sub>5</sub>:K<sub>2</sub>O per ha may be given. Half the dose of nitrogen, full phosphorus and half of potash may be applied as basal before transplanting. One fourth of nitrogen and half of potash may be applied 20-30 days after planting. The remaining quantity may be applied two months after planting.

#### After cultivation

Irrigate at two or three days interval. Stake the plants if necessary. Weeding followed by fertilizer application and earthing up may be done at one and two months after transplanting.

#### Plant protection

Damping off : Management as in Brinjal. Soil solarization of nursery beds for 30 days prior to sowing and seed treatment with Trichoderma (5 g kg<sup>-1</sup> seed) is effective in managing the disease.

Uproot and destroy the plants affected by bacterial wilt and mosaic. Cultivate resistant varieties like Sakthi, Mukthi and Anagha in bacterial wilt prone areas.

## VEGETABLE COWPEA (*Vigna unguiculata*)

### Varieties

#### 1. Vegetable type:

(a) Bushy: Bhagyalakshmy, Pusa Barsathi, Pusa Komal., Kashi Kanchan.

(b) Semitrailing: Kairali, Varun, Anaswara, Kanakamony (PTB-1), Arka Garima.

(c) Trailing type: Sharika, Malika, KMV-1, Lola, Vyjayanthi, Manjeri Local, Vyalathur Local, Kurutholapayar, Vellayani Jyothika and Geethika.

#### Seeds and Sowing

#### Seed rate

### For vegetable type

Bush : 20-25 kg ha<sup>-1</sup>

Trailing : 4-5 kg ha<sup>-1</sup>

Spacing : 25 cm x 15 cm Dibbling two seeds per hole

Bush : 30 cm x 15 cm

Trailing : 2 m x 2 m (on pandal @ three plants per pit)

#### Plant protection

Apply Glycicidia @ 4.5 t ha<sup>-1</sup> along with neem cake @ 1 t ha<sup>-1</sup> and Trichoderma (1 kg/ 100 kg FYM) to manage root rot and collar rot.

## COOL SEASON VEGETABLES

### CABBAGE (*Brassica oleracea* var. *capitata*)

Cabbage can be grown successfully in the plains as well as high ranges of Kerala. Well drained soil with open sunlight is ideal for growth of the crop.

#### Varieties

NS 43, NS 160, NS 183.

#### Planting requirements

Since it is a cool season crop sowing is to be done during October - November. Seed rate is 600 - 750 g/ha<sup>1</sup>. Seeds are to be sown in nursery beds or in protrays. The trays should be filled with a mixture of well decomposed cocopeat, perlite and vermiculite (3:1:1 by volume). Germinated seedlings should be fertigated with 19:19:19/20:20:20/30:10:10 water soluble fertilizer @ 0.05 - 0.2% depending on the stage of growth of seedlings. The seedlings will be ready for transplanting within 3-4 weeks. Damping off disease in nursery beds can be controlled by applying copper oxy chloride (0.3%).

The main field is prepared by ploughing the soil well. Trenches of 20 cm depth should be taken at a spacing of 60 cm. Apply the basal dose of organic manures and fill the trenches up to 10 cm using top soil. Plant the seedlings in trenches at a spacing of 60 cm.

#### Manures and Fertilisers

Apply 25t/ha FYM or compost. Fertiliser dose is N:P<sub>2</sub>O<sub>5</sub>:K<sub>2</sub>O 150:100:125 kg/ha. Apply half the dose of N, K and full dose of P<sub>2</sub>O<sub>5</sub> 5-7 days after transplanting. Apply the remaining N & K after one month of planting.

#### After cultivation

A continuous supply of moisture is necessary for proper development of curds. Very shallow hoeing should be done at weekly intervals to remove weeds and better aeration of soil. Earth up the plant one month after transplanting.

#### Plant protection

Army worms and semi loopers are the major pests. Spraying quinalphos 0.25% controls the pests. Black rot is a serious problem which can be controlled by spraying streptomycin 300 ppm. Weekly application of *Pseudomonas fluorescens* 2% solution after the head initiation also controls the disease. Collar rot is observed in soils with poor drainage and aeration. Incidence of collar rot can be managed by weekly hoeing. Drenching *Pseudomonas fluorescens* 2% controls the disease.

### CAULIFLOWER (*Brassica oleracea* var. *botrytis*)

Cauliflower can be grown successfully in the plains as well as high ranges of Kerala. Well drained soil with open sunlight is ideal for growth of the crop.

#### Varieties

Basant, NS 60, Pusa Meghna.

#### Planting requirements

Since it is a cool season crop sowing is to be done during October - November. Seed rate is 600 - 750 g/ha. Seeds are to be sown in nursery beds or in protrays. The trays should be filled with a mixture of well decomposed

cocopeat, perlite and vermiculite (3:1:1 by volume). Germinated seedlings should be fertigated with 19:19:19/20:20:20/30:10:10 water soluble fertiliser @ 0.05 - 0.2% depending on the stage of growth of seedlings. The seedlings will be ready for transplanting within 3-4 weeks.

The main field is prepared by ploughing the soil well. Trenches of 20cm depth should be taken at a spacing of 60 cm. Apply the basal dose of organic manures and fill the trenches up to 10 cm using top soil. Plant the seedlings in trenches at a spacing of 60 cm.

#### Manures and Fertilisers

Apply 25t ha<sup>-1</sup> FYM or compost. Fertiliser dose is N:P<sub>2</sub>O<sub>5</sub>:K<sub>2</sub>O 150:100:125 kg ha<sup>-1</sup>. Apply

half the dose of N, K and full dose of P<sub>2</sub>O<sub>5</sub> 5-7 days after transplanting. Apply the remaining N & K after one month of planting.

#### After cultivation

A continuous supply of moisture is necessary for proper development of curds. Very shallow hoeing should be done at weekly intervals to remove weeds and better aeration of soil. Earth up the plant one month after transplanting.

#### Plant protection

Damping off disease in nursery beds can be controlled by applying copper oxy chloride (2 g l<sup>-1</sup>).

## CARROT (*Daucus carota*)

Carrot can be grown in high ranges from August to January. Well-drained sandy loam soil is best suited for the crop.

#### Varieties

Pusa Kesar, Nantes, Pusa Meghali, Pusa Nayanjyothi F<sub>1</sub> (suited for commercial cultivation in the tropical plains of Kerala).

#### Planting requirements

Seed rate is 5-6 kg ha<sup>-1</sup>. It is usually sown on ridges to facilitate good root production. Ridges of about 20 cm height are made 45 cm apart and seeds sown 10 cm apart on the rows. The seed is mixed with fine sand and sown in rows by hand and covered with soil to make it firm around it.

#### Manures and fertilizers

Apply 25 t ha<sup>-1</sup> FYM before sowing.

Fertilizer recommendation is 75:62.5:50 NPK kg ha<sup>-1</sup>. A fertilizer dose of 37.5 kg N, 62.5 kg P<sub>2</sub>O<sub>5</sub> and 50 kg K<sub>2</sub>O per ha as basal. Topdressing with 37.5 kg N per ha may be done one month after sowing.

#### After cultivation

It is necessary that enough soil moisture is available to help uniform seed germination and growth of plant. Uproot excess seedlings (thinning) three weeks after sowing leaving a plant to plant spacing of 10 cm to facilitate better tuber growth. Weeding should be done at regular intervals to keep down the weeds. Shallow hoeing is necessary to facilitate root growth. When the root starts growing, earthing up should be done.

## BEEET ROOT (*Beta vulgaris* Var. *esculenta*)

Beet root can be grown in high ranges from August to January. Well-drained sandy loam soils are best suited for the crop.

Varieties: Detroit Dark Red

Planting requirements

Seed rate is 7 to 8 kg ha<sup>-1</sup>. It is usually grown on ridges to facilitate good root production. Ridges of about 20 cm height are formed 45 cm apart and seeds sown 15-20 cm apart on the rows. The seeds are mixed with fine sand and placed in rows by hand and covered with soil to make it firm around it.

Manures and fertilizers

Apply FYM 20 t ha<sup>-1</sup> as basal. N:P<sub>2</sub>O<sub>5</sub>:K<sub>2</sub>O

75:37.5:37.5 kg ha<sup>-1</sup> is recommended. Full dose of P<sub>2</sub>O<sub>5</sub> and K<sub>2</sub>O and half dose of N are applied as basal. Remaining half dose of nitrogen is applied as topdressing when the plant starts growing vigorously.

After cultivation

It is necessary that enough soil moisture is available to help uniform seed germination and growth of plant. Thinning the population may be done as in carrot. Weeding should be done at regular intervals to keep down the weeds. Shallow hoeing is necessary to facilitate root growth. When the root starts growing, earthing up should be done.

## RADISH (*Raphanus sativus*)

Radish can be grown in high ranges from June to January. Well drained sandy loam soils are best suited for the crop.

Varieties

Japanese White, Arka Nishanth, Pusa Chethki, Pusa Reshmi and Pusa Desi.

Planting requirement

Seed rate is 7 to 8 kg ha<sup>-1</sup>. It is usually grown on ridges to facilitate good root production. Ridges of about 20 cm height are taken 45 cm apart and plants are grown 10 cm apart on the rows. The seed is mixed with fine sand and sown in rows by hand, covered with soil to make it firm around it.

Manures and fertilizers

Apply 20 t ha<sup>-1</sup> FYM as basal. N: P<sub>2</sub>O<sub>5</sub>:K<sub>2</sub>O 75:37.5:37.5 kg ha<sup>-1</sup> is the fertilizer requirement. Full dose of P<sub>2</sub>O<sub>5</sub> and K<sub>2</sub>O and half dose of N are applied as basal. Remaining half dose of nitrogen is applied as topdressing when the plant starts growing vigorously.

After cultivation

It is necessary that enough soil moisture is available to help uniform seed germination and growth of plant. Thinning may be done at 10 cm distance as in carrot. Weeding should be done at regular intervals to keep down weeds. Shallow hoeing is necessary to facilitate root growth. When the roots start growing, earthing up should be done.

## POTATO (*Solanum tuberosum*)

Potato can be successfully cultivated in the high ranges of Kerala. It is being cultivated in the rain shadow areas of Idukki district throughout the year. A day temperature of 20-30°C is optimum for growth and tuberisation in potato. Tuber formation is adversely affected, if the temperature goes above 30°C.

### Season

Crops can be raised as shown below in the eastern part of Idukki district.

Summer	:	March-April
Autumn	:	August-December
Spring	:	January-February

### Varieties

Among the high yielding varieties, Kufri Jyothi (early), Kufri Muthu (medium) and Kufri Dewa (late) can be tried in the high ranges of Kerala.

### Soil

Loose friable sandy loam or silt loam, rich in organic matter are ideal for potato. Hard clay should be avoided. Optimum pH range is 5.2-7.0.

### Planting

Whole potato tuber or cut pieces (50-60 g size) longitudinally cut from bud-end to stem end can be used for planting. For

planting 1 ha, 1000-2000 kg seed tubers are required. Seed tubers are treated with 1 ppm of GA 3 for one hour and then dried in shade for getting uniform sprouting. Tubers are filled in gunny bags after drying and kept in vertical position in well-ventilated dark room for 10 days for encouraging sprouting. Seed pieces should be treated with mancozeb (@ 1 kg in 450 litres of water) before planting to protect them from soil borne diseases. Tubers can be planted on ridges 50-60 cm wide at a spacing of 15-20 cm between the plants. Earthing up is needed during the growing phase (30 days after planting) and 70 days after planting.

### Manuring

A basal application of FYM (20 t ha<sup>-1</sup>) is required during field preparation. Fertilizer recommendation is 120:100:120 kg NPK ha<sup>-1</sup>. Apply 60 kg N, 100 kg P<sub>2</sub>O<sub>5</sub> and 120 kg K<sub>2</sub>O as basal. Top dressing with 60 kg N, 30 days after planting at the time of first earthing up is essential.

### Plant protection

Early blight and late blight are the important fungal diseases. Copper fungicides can control both diseases.

Cut worms, aphids and jassids are common pests of potato. To control aphids and jassids spraying dimethoate (0.05 per cent) is effective.

## ONION (*Allium cepa* L.) (Ad hoc recommendation)

Onion can be successfully cultivated in mid lands of Kerala during October - November. It requires a cool climate during vegetative growth phase and a dry spell during maturity

of bulbs. Fertile and well drained soils are ideal for cultivation. The crop will not tolerate water logging. Open sunlight is essential for good yield.

Varieties: Agri Found Dark Red and Arka Kalyan are suited to Kerala conditions.

#### Nursery preparation and transplanting

The nursery should be raised in a rain shelter. Seeds can be sown in nursery beds or pro-trays during September. Incorporate well rotten compost mixed with Trichoderma in the nursery beds. Six to eight week old seedlings having 0.6 - 0.8 cm collar girth can be transplanted to the main field during October - November. About 1500 - 2000 seedlings will be required to plant one cent (40 m<sup>2</sup>) area in the main field.

Plough the land thoroughly, incorporate FYM @ 20 t/ha. Liming should be done so as to maintain a pH range of 5.8- 6.5. Seedlings can be transplanted in flat beds at the rate of one seedling per hill. A spacing of 15 - 20 cm between rows and 10 cm between plants should be given.

Planting on ridges or raised beds can also be adopted to ensure good drainage. Gap filling if necessary may be done at 10-15 days after planting. Weeding and hoeing may be done at 10 days intervals up to 30- 40 DAP. A fertilizer dose of 80:40:60 N: P<sub>2</sub>O<sub>5</sub>: K<sub>2</sub>O kg/ha may be applied in two split doses, half N and K and full P basally and remaining N and K at one month after transplanting. Only light earthing up may be done after fertilizer application. Need based irrigation must be given. Irrigation should be withheld one week before harvest.

#### Harvesting

The crop will be ready for harvest by 3.5 - 4 months after transplanting (February - March) when the bulbs are fully matured and 75% leaves are dried off. The individual plants are raked out or pulled out from the soil. The tops are cut from the bulb leaving 2 cm length from the bulb and dried in shade for 3-5 days.

Average yield of bulbs is 6-8 t ha<sup>-1</sup>.

## GARLIC (*Allium sativum*)

Garlic requires cool and moist period during vegetative growth and a dry spell during maturity of the bulbs. Fertile, well-drained loamy soils are ideal for garlic cultivation. Heavy clay soils may result in deformed bulbs. In high ranges of Kerala garlic can be planted during October-November.

Varieties: Ooty-1, G 50

#### Planting requirements

Cloves or bulbils are used for propagation. For planting one hectare, 500 kg of cloves is

required. The cloves for planting should be stored for 2-3 months after harvest and cloves weighing 4 g are ideal for planting. The cloves should be soaked in water followed by dipping for 15 minutes in a solution containing 1 g of carbendazim dissolved in 1 litre of water for 15 minutes. After drying in shade, cloves can be used for planting. Dig the land thoroughly and prepare beds of 15 cm height at a width of 1 m and of convenient length. The cloves should be dibbled at a spacing of 15 cm x 8 cm. Germination will start on the fifth day and it will be completed within 10-15 days.



**Manuring**

Apply N:P<sub>2</sub>O<sub>5</sub>: K<sub>2</sub>O @ 60:120:120 kg ha<sup>-1</sup> 20 days after transplanting (DAP). Top dressing of N should be done @ 60 kg ha<sup>-1</sup>, 45 DAP.

**After cultivation**

Earthing up should be done 60 DAP.

**Plant protection**

To control blast, spray mancozeb (2 g l<sup>-1</sup>).

**Harvest**

Harvesting can be done 120-130 DAP. Yield may vary from 5-10 t ha<sup>-1</sup>.

## MINOR VEGETABLES

**Dolichos bean (*Lablab purpureus*)**

Pole varieties : Hima, Grace and Pusa Early Prolific

Bush variety : Arka Vijay

Pole varieties are sown in pits (three plants per pit) at a spacing of 1.25 m x 0.75 m and bush varieties in ridges and furrows at a spacing of 60 cm x 15 cm. Seeds are to be sown during July-August. The plants are trailed over pandals, trellis or stakes. FYM is applied @ 20 t ha<sup>-1</sup>. N:P<sub>2</sub>O<sub>5</sub>: K<sub>2</sub>O recommendation for the crop is 50:100:50 kg ha<sup>-1</sup>. The leaf caterpillar is a common pest of the crop. It is also affected by Fusarium wilt, collar rot, anthracnose and powdery mildew. Average yield is 6-10 t ha<sup>-1</sup>.

**Winged bean**

(*Psophocarpus tetragonolobus*)

The common varieties in use are Revathy, PT-62, PT-16, PT-49 and PT-2. Seeds @ 15 to 20 kg ha<sup>-1</sup> are planted at a spacing of 125 cm x 50 cm during August-September and are trailed over pandal, trellis or stakes. FYM is applied @ 20 t ha<sup>-1</sup>. N, P<sub>2</sub>O<sub>5</sub> and K<sub>2</sub>O recommendation for the crop is 50:100:50 kg ha<sup>-1</sup>. The crop is comparatively free from pests and diseases. Average yield is 10-15 t ha<sup>-1</sup>.

**Cluster bean (*Cyamopsis tetragonoloba*)**

Pusa Naubahar and Pusa Sadabahar are the

common varieties. Seeds @ 10 to 12 kg ha<sup>-1</sup> are planted at a spacing of 45-60 cm x 20-30 cm in February-March and June-July. During rainy season, the seeds are sown 2-3 cm deep on ridges and in furrows during summer months. FYM is applied @ 25 t ha<sup>-1</sup>. N, P<sub>2</sub>O<sub>5</sub> and K<sub>2</sub>O recommendation for the crop is 20:60:80 kg ha<sup>-1</sup>. Aphids and powdery mildew are the common pest and disease of the crop. Average yield is 5 to 6 t ha<sup>-1</sup>.

Sword bean (*Canavalia gladiata*) and Jack bean (*Canavalia ensiformis*)

Sword bean is trailing and red seeded while Jack bean is bushy and white seeded. Sword bean is to be planted at a spacing of 4 m x 3m whereas Jack bean is to be planted at 60 cm x 60 cm.

May-June and September- October are the usual sowing time and the seed rate followed is one or two seeds per pit. FYM is applied at the rate of 5 t ha<sup>-1</sup>. The N:P<sub>2</sub>O<sub>5</sub>:K<sub>2</sub>O mixture (7:10:5) may be applied as basal dose and top dressing at several splits. There is no serious pest or disease incidence in the crop. Average yield is 10-15 kg per plant.

**Clove bean (*Ipomoea muricata*)**

The crop can be grown throughout the year and are trailed over trellis or stakes. The seeds @ 6-7 kg ha<sup>-1</sup> are planted at a spacing of 1.0 m x 0.6 m. FYM is applied @ 10 t ha<sup>-1</sup>.

N:P<sub>2</sub>O<sub>5</sub>:K<sub>2</sub>O recommendation for the crop is 35:50:25 kg ha<sup>-1</sup>. There is no serious pest or disease incidence in the crop. Average yield is 5-6 t ha<sup>-1</sup>.

Ivy gourd (*Coccinia grandis*)

Variety - Sulabha

Local varieties are grown in May-June and September-October by trailing over pandals and stakes. Stem cuttings with three or four nodes and 30-40 cm length, selected from high yielding female vines are used as planting material. These are planted at a spacing of 4 m x 3 m. FYM @ 25 kg per pit is given in two doses. No serious pests or diseases are reported except mild attack of fruit flies and gall insects.

Smooth gourd (*Luffa cylindrica*)

Pusa Chickni is the common variety in use. The crop is planted in February-March and May-June at a spacing of 2 m x 2 m. The seed rate is 2.5-3 kg ha<sup>-1</sup>. The crop is trailed over pandal, stakes or trellis. FYM @ 25 t ha<sup>-1</sup> is given in two doses. N:P<sub>2</sub>O<sub>5</sub>:K<sub>2</sub>O recommended for the crop is 70:25:25 kg ha<sup>-1</sup>. No serious pests or diseases are reported. The average yield is 10-15 t ha<sup>-1</sup>.

Ridge gourd (*Luffa acutangula*)

The important varieties are Haritham, Pusa Nasdhar Co-2 and Deepthi. The crop is usually sown during February-March and May-June. Seed rate recommended is 2.5-3.0 kg ha<sup>-1</sup> with a spacing of 2 m x 2 m. FYM @ 25 t ha<sup>-1</sup> and N:P<sub>2</sub>O<sub>5</sub>:K<sub>2</sub>O @ 70:25:25 kg ha<sup>-1</sup> are recommended. It is usually trailed over pandals or trellis. Average yield is 10 to 15 t ha<sup>-1</sup>.

Bell pepper

(*Capsicum annuum* var. *grossum*)

Hungarian Wax, California Wonder and Early Calwonder are the promising

varieties. Plant the crop during September-October at a spacing of 60 cm x 30 cm. The seed rate is 400-600 g ha<sup>-1</sup>. Raising of seedlings, transplanting, irrigation etc. are same as in chilli. FYM @ 25 t ha<sup>-1</sup> and N:P<sub>2</sub>O<sub>5</sub>:K<sub>2</sub>O @ 150:75:50 kg ha<sup>-1</sup> are to be given. The average yield is 12-15 t ha<sup>-1</sup>.

Drumstick (*Moringa oleifera*)

Variety: Anupama (Early flowering habit and suitable for Central Zone).

The major planting season is May-June. Stem cuttings of 1.0-1.5 m length and 15-20 cm girth are used as planting material. Plant the cuttings in polybags and later sprouted cuttings can be shifted to main field. For one hectare, 625 cuttings are required. These are planted at a spacing of 4 m x 4 m. FYM @ 10-20 kg per pit and N:P<sub>2</sub>O<sub>5</sub>:K<sub>2</sub>O @ 60:80:40 g per pit are recommended. Green caterpillar and hairy caterpillar are the common pests. The average yield is 10-15 kg per tree per year.

Chekkurmanis (*Sauropus androgynus*)

Stem cuttings of 6-12 months old, 20-30 cm length are to be planted in May-June. These are usually grown on borders of kitchen gardens. To check the height of the plant and to get frequent harvests, the tips are clipped off intermittently. FYM @ 5 kg per plant per year and N:P<sub>2</sub>O<sub>5</sub>:K<sub>2</sub>O (7:10:5) mixture @ 30 g per plant are recommended. The average yield is 2 - 5 kg per m<sup>2</sup> per year.

Indian spinach (*Basella* sp.)

Seeds or stem cuttings of 20-30 cm length are to be planted during May-June and September-October. The spacing recommended is 1.0 m x 0.6 m. These are usually trailed over pandals or stakes. FYM @ 2-5 kg per m<sup>2</sup> is to be given. The average yield is 1-2.5 kg per m<sup>2</sup>.

**Water leaf (*Talinum triangulare*)**

This is a shade loving leafy vegetable grown in May-June and September-October. Semi hard stem cuttings of 10-15 cm length are planted at a spacing of 30 cm x 10 cm. FYM @ 2-5 kg per m<sup>2</sup> is given. The average yield is 2.0-2.5 kg per m<sup>2</sup>.

**Curry leaf (*Murraya koenigii*)**

It is usually planted in May-June. Root suckers are used as planting material. The recom-

mended spacing is 4 m x 4 m with 625 plants per hectare. FYM @ 10 kg per plant per year is given. N:P<sub>2</sub>O<sub>5</sub>:K<sub>2</sub>O @ 60:80:40 g per adult plant per year is recommended. Major pests are citrus butterfly and psyllid. Diaphorina pink disease is also seen. The average yield is 2-2.5 kg per m<sup>2</sup>.

Waiting periods for insecticides on vegetables

Waiting periods for insecticides on vegetables are given in the Table 31.

Table 31. Waiting periods for insecticides on vegetables

Vegetable	Quinalphos	Malathion	Dimethoate	Spiromesifen 22.9SC @ 96 g ai/ha	Fenpyroximate 5EC @ 15 g ai/ha	Thiamethoxam 25WG @ 50 g ai/ha	Diafenthiuron 50WP @ 300 g ai/ha
Okra	3 days	3 days	3 days	-	-	-	-
Bitter gourd	5 days	4 days	2 days	-	-	-	-
Brinjal	3 days	3 days	3 days	5 days	-	3 days	3 days
Snake gourd	6 days	1 days	3 days	-	-	-	-
Tomato	-	1 days	5 days	-	-	-	-
Chilli	-	1 days	4 days	7 days	7 days	-	-

Note: Washing vegetables in 2 percent table salt solution or 2 percent vinegar and thorough washing in water using scrubber were found to remove residues of contact insecticides.

## TIPS FOR VEGETABLE SEED PRODUCTION

### General principles

The seed production programme envisages to produce genetically pure quality seeds and to store them in a viable condition for a reasonable period of time, until it reaches the farmers. The seeds should have genetic purity, uniformity in size and shape, high germination and vigour. The seeds should be free from mechanical damages, insect and fungal infestation and other crop and weed

seeds. A commercial seed production programme has three aspects—seed production, seed processing and seed storage.

#### a. Seed production

Important aspects of seed production are as follows:

1. Basic knowledge on the specific requirement of the crop (climate, soil requirement etc.), specific characteristics of the

- variety, pests and diseases and their control measures are essential before taking up the seed production programme.
2. In general, September to January is the most suitable season for taking up seed production in Kerala.
  3. Site selected for seed production should be open, receiving good sunlight, well drained and fertile soil, free from infectious pest and disease organisms.
  4. Seeds for multiplication should be obtained from reliable sources.
  5. Proper isolation distance should be maintained between varieties and related species.
  6. Scientific roguing (removal of off-types at nursery stage, vegetative phase, flowering, fruiting and harvest stages) should be practiced.
  7. All plants infected by diseases should be removed from the seed production plot. No objectionable weeds are permitted in seed production plot.
  8. In general, for most vegetable crops, taking one or two vegetable harvests is found ideal for economic seed production.
  9. Provide one additional topdressing with N and  $K_2O$  at fruit development phase, adequate irrigation and plant protection measures.
  10. General cultivation and plant protection practices recommended for vegetable production can be adopted in seed crop also.
  11. Harvest the crop at optimum fruit maturity, since immature and over mature fruits affect the seed quality.
- b. Seed processing
1. Seed processing involves extraction of seeds from the fruits and reducing the seed moisture content to a level of 6-8 per cent.
  2. Wet and dry methods of seed extraction are adopted depending on the nature of the crop. Slow drying at low temperature (below  $38^{\circ}C$ ) is advisable rather than quick drying at high temperature.
  3. Exposing seeds to open sunlight during peak hours of sunshine (12 noon to 3 p.m.) should be avoided.
  4. Spread the seeds in thin layer and give frequent raking for aeration while drying to avoid fungal infestation.
  5. Clean the seeds by removing inert matter, damaged and underdeveloped seeds etc. to get uniform quality seeds.
- c. Seed storage
1. Store seeds under cool and dry conditions to maintain the viability.
  2. Seed moisture content of 6-8 per cent, atmospheric temperature of  $22^{\circ}C$  and relative humidity of 45 per cent are the most ideal conditions for seed storage. The sum of storage temperature ( $^{\circ}C$ ) and humidity (per cent) should not exceed 80.
  3. Pre-storage seed treatment with fungicides (captan or thiram @  $2.5\text{ g kg}^{-1}$  of seeds) would protect the seeds from various fungal and insect infestations.
  4. Store the treated seeds in 700 gauge polythene bags in sealed conditions. Specific recommendations for seed production of the individual crops other than the general aspects mentioned above are given below:
- Solanaceous vegetables
- Tomato
- The best time for planting tomato for seed production is October. Give an isolation distance of 50 m for foundation seed (FS)

production and 25 m for certified seed (CS) between varieties. Rogue out off-types and virus infected plants. Maximum off-types and diseased plants permitted is 0.1 per cent each only. Seeds should have a minimum purity of 98 per cent and germination of 70 per cent. Maximum permitted inert matter content is 2 per cent, other crop seeds 0.1 per cent, weed seeds 0.1 per cent, and maximum moisture content 8 per cent.

#### Brinjal

Give an isolation distance of 200 m for FS and 100m for CS. Remove off-types and plants infected by little leaf disease. No objectionable weeds are permitted in the seed production plot. Maximum level of off-types and plants infested by designated diseases are 0.1 per cent each. Seeds should have a minimum purity of 98 per cent and germination of 70 per cent. Maximum inert matter content permitted is 2 per cent, other crop seeds 0.1 per cent, weed seeds 0.1 per cent and maximum moisture content 8 per cent.

#### Chilli

Provide an isolation distance of 400 m for FS and 200 m for CS. Remove off-types and plants infected by virus diseases. No objectionable weeds are permitted in the seed production plot. Maximum level of off-types and plants infested by designated diseases are 0.1 per cent each. Fruits of 45-50 days maturity may be harvested for seed extraction in the case of Jwalasakhi and Ujwala. Seeds should have a minimum purity of 98 per cent and germination of 70 per cent; maximum inert matter content permitted is 2 per cent, other crop seeds 0.1 per cent, weed seeds 0.1 per cent and maximum moisture content 8 per cent. Seed treatment with Trichoderma @ 5 g/kg seed is effective in managing seed borne

diseases and damping off in chilli and to get maximum germination and seedling vigour.

#### Okra

Provide an isolation distance of 400 m for FS and 200 m for CS. Remove off-types and plants infected by yellow vein mosaic disease. No objectionable weeds are permitted in the seed production plot. Maximum level of off-types and plants infected by yellow vein mosaic is 0.1 per cent each. It is economical to take two vegetable harvests and then retain the crop for seed production. Fruits of 36 days maturity may be harvested for seed extraction in the case of Arka Anamika. At this stage the pod colour completely turns to brown and tips dry. Seeds can be stored in polythene bags of 700 gauge thickness. Seeds should have a minimum purity of 99 per cent and germination of 65 per cent. Maximum inert matter content permitted is 1 per cent; no seeds of other crops or weeds are permitted and maximum moisture content permitted for open storage is 10 per cent and for storing in moisture proof containers is 8 per cent.

#### Cucurbits

##### General

An isolation distance of 800 m for FS and 400 m for CS is required between varieties and related species. Remove off-types, wild cucurbits and plants infected by designated diseases. No objectionable weeds are permitted in the seed production plot. Maximum level of off-types and plants infected by yellow vein mosaic diseases is 0.1 per cent each. Seeds should have a minimum purity of 99 per cent and germination of 60 per cent. Maximum inert matter content permitted is 1 per cent. No seeds of other crops or weeds are permitted and maximum moisture content should not exceed 7 per cent.

### Bitter gourd

Taking two vegetable harvests and then leaving the crop for seed production is economical. Fruits of Preethi variety should be harvested 21-24 days after anthesis to get maximum recovery of good quality seeds. At this stage, lower one third of fruit turns yellow. Ripe fruits of 24 days maturity in Preethi, when the whole fruits turn to bright orange colour, can be harvested for seed extraction. Seeds may be dried in the sun, avoiding peak sunshine hours of 12 noon to 3 p.m. Seeds can be stored in 700 gauge thick polythene bags. Soaking seeds for 3 hours in 1:10 solution of 150 ppm  $\text{KNO}_3$  increases seed germination and seedling vigour.

### Snake gourd

Fruits can be harvested for seed extraction 36 days after anthesis (Harithasree), when yellowing of fruits start from the stylar end. Big and medium sized fruits (above 85 cm length and 2 kg weight in Kaumudi) give maximum quantity of quality seeds.

### Oriental pickling melon

Harvest fully ripe fruits with deep orange colour (30 days after anthesis in Mudicode), when the vines wither. Select big and medium sized fruits (above 1.25 kg in Mudicode) for quality seeds.

Machine extraction (without fermentation of pulp) and drying under shade for one day and then in sun avoiding peak hours (12 noon to 3.00 pm) to 8 per cent moisture gives good quality seeds.

### Ash gourd

Ash gourd fruits of 70 days maturity after anthesis are suitable for seed extraction. At this stage the vines wither and the sticky

thick ashy coating on the fruits dries into white powder, which can be removed on rubbing. Fruits of medium and large size (above 5 kg in KAU Local) give bolder, quality seeds. It is advisable to have a post-harvest storage of fruits for three months to get higher germination.

Manual extraction of pulp from the fruits and fermenting the pulp for 48 hours is better to get quality seeds without mechanical damage.

Acid treatment of pulp using 2 per cent HCl (1:10) for 30 minutes followed by drying under shade to 8 per cent moisture also gives good quality seeds.

Pre-storage treatment of seeds with captan @ 2.5 g  $\text{kg}^{-1}$  and storing in sealed polythene bags of 700 gauge thickness is the best for seed storage.

### Water melon

Manual extraction with acid treatment using 1 per cent HCl (1:10) for 30 minutes and drying under shade for one day and then in sun, avoiding peak hours (12 noon to 3.00 p.m) to 8 per cent moisture gives good quality seeds.

### Vegetable cowpea

Dried pods can be harvested for seed purpose. These pods are further dried in the sun before seed extraction. Good drying and pre-storage seed treatment of seeds is essential to protect them from Bruchus and fungal infestations.

### Amaranth

It is economical to take one vegetable harvest at 30 days after planting and then leaving the crop for seed production.

## GUIDELINES FOR HOMESTEAD CULTIVATION OF VEGETABLES IN RAIN SHELTERS

Site selection: Shade free areas in garden lands with good drainage.

Rain shelter Size: 40 m<sup>2</sup> (9.0m length and 4.5m width), Centre height 3.8 - 4.0m and side height 2.5 m (Length and breadth can be varied according availability of suitable land).

Roof: 200  $\mu$  UV stabilized polythene sheet with sides open.

Cropping sequence: 10 - 12 rows of crops, crop arrangement with no mutual shading.

Ist crop: (June - July to Sept. - Oct.)

Bush : Cowpea, Bhindi, Tomato, Chilli, Amaranthus, Cluster beans.

Trailing: OP melon, Cucumber, Bitter gourd, Yard long bean, Snake gourd.

IIInd crop: (Oct - Dec - Jan)

Bush: Cabbage, Cauliflower, Bhindi, Brinjal, Chilli, Tomato and Amaranthus.

Trailing: Bitter gourd, Snake gourd, Yard long bean.

IIIrd crop: (Jan - May)

Bush: Amaranthus, Brinjal and Chilli.

Trailing: Yard Long Bean and Cucumber.

Varieties:

Tomato : Manuprabha, Manulakshmi, Anagha, Akshaya

Brinjal : Neelima

Bhindi : Arka Anamika, Varsha Uphaar

Chilli : Anugraha

Amaranth : CO 1, Arun, Renusree

Bittergourd : Preethi, Priya

Snake gourd : Baby

OP melon : Sowbhagya

Cucumber : AAU C 2

Yard long bean : Vellayani Jyothika

Spacing: Row to row - 60 cm for non trailing types and 1m for trailing types.

10 plants each of bhindi, brinjal, chilli, tomato and cluster bean in each row

15 - 20 plants of bush cowpea, cabbage, cauliflower and amaranthus in each row

4 - 5 plants of trailing crops in each row

Crop management: Mulching, trailing on trellis and drip/channel irrigation recommended. In summer 25% shade to be provided and non chemical methods for plant protection are effective.

Maintenance: After 3 years replacement of UV sheet recommended.

## FRUITS

### BANANA (*Musa* spp.)

Banana prefers tropical humid lowlands and is grown from the sea level to 1000 m above MSL. It can also be grown at elevations up to 1200 m, but at higher elevations growth is poor. Optimum temperature is 27°C. Soils with good fertility and assured supply of moisture are best suited.

#### Season

Rain fed crop : April-May

Irrigated crop : August-September

Adjust planting season depending upon local conditions. Avoid periods of heavy monsoon and severe summer for planting. Adjust the time of planting so as to avoid high temperature and drought at the time of emergence of bunches (7-8 months after planting).

#### Varieties

Nendran (Clones): Nedunendran, Chengalikodan, Manjeri Nendran, Zanzibar, Big Ebanga. Growth and yield characteristics of popular banana Nendran varieties are given in Table 32.

Table varieties: Monsmarie, Robusta, Giant Governor, Dwarf Cavendish, Chen-

kadali, Poovan, Palayankodan, Njalipoovan, Amritsagar, Gros michael, Karpooravally, Poomkalli, Koopillakannan, Chinali, Dudhsagar, BRS-1, BRS-2 and Yangambi.

Culinary varieties: Monthan, Batheesa, Kanchikela, Nendrapadathy

Njalipoovan, Robusta, BRS-1 and BRS-2 are particularly suitable for intercropping in coconut gardens both under rainfed and irrigated conditions. Dudhsagar is highly resistant to major pests and diseases. The variety Bodles Altafort is recommended for high range region (ad hoc).

#### Preparation of land

Prepare the field by ploughing or digging and dig pits for planting. Size of pits depends upon soil type, water table and variety. In general, pit size of 50 cm x 50 cm x 50 cm is recommended. In low-lying areas, take mounds for planting suckers.

#### Selection of suckers

Select 3-4 month old disease free sword suckers from healthy clumps. In the case of Nendran variety, cut back pseudostem to a length of 15-20 cm from crown and remove old roots. The rhizomes are to be smeared with cowdung solution and ash and dried in the sun

Table 32. Growth and yield characters of Nendran

Clonal name	Plant height (cm)	Pseudostem girth (cm)	No. of leaves	Crop duration (days)	Bunch weight (kg)	No. of hands	No. of fruits	Fruit weight (g)
Nedunendran	292.0	46.0	14.0	290.0	10.50	5.53	47.6	157.6
Chengalikodan	332.0	49.0	14.0	333.0	12.60	6.25	65.0	172.3
Zanzibar	351.0	56.0	15.0	331.0	11.75	2.30	23.0	390.0
Big Ebanga	346.0	53.0	15.0	335.0	12.70	7.00	45.0	250.0
Manjeri Nendran	327.0	52.0	16.0	336.0	14.00	6.86	65.0	180.5



for about 3-4 days and stored in shade upto 15 days before planting.

#### Spacing

Spacing may be provided as indicated below:

Variety	Spacing (m)	Suckers/ha
Poovan Chenkadali Palayankodan Monthan	2.1 x 2.1	2260
Nendran	2.0 x 2.0	2500
Gros michael	2.4 x 2.4	1730
Robusta, Monsmarie, Dwarf Cavandish	2.4 x 1.8	2310

#### Planting

Plant suckers upright in the centre of pits with 5 cm pseudostem remaining above soil level. Press soil around the sucker to avoid hollow air spaces.

#### Manuring

1. Apply compost, cattle manure or green leaves @ 10 kg/plant at the time of planting.

For double sucker planting at a spacing of 3 m x 2 m, 133 per cent of recommended dose for single sucker planting in six splits is needed when farm yard manure is used as the organic source. The recommended dose for single sucker itself is sufficient with vermicompost as organic source. This should be accompanied with in situ green manuring @ 15 g cowpea seeds per pit (25 kg ha<sup>-1</sup>) at the time of planting. Incorporate the cowpea crop into soil 40 days after sowing.

Plant crop followed by two ratoon crops gives maximum yield. Two suckers per clump should be retained for ratooning.

2. Apply N:P<sub>2</sub>O<sub>5</sub>:K<sub>2</sub>O at the following dose (g/plant/year).

Nendran (irigated): 190:115:300

Other varieties depending upon soil fertility level: 160-200 : 160-200 : 320-400  
Palayankodan (rainfed): 100:200:400  
Palayankodan (reclaimed alluvial soils of Kuttanad)

Plant crop : 100:200:400

First ratoon : 150:200:800

Second ratoon : 150:200:800

Apply the fertilizer 60-75 cm around the plant in two equal split doses; the first, two months after planting and the second, four months after planting. For ratoon crop, the entire fertilizers have to be applied in a single dose immediately after the harvest of the preceding crop. Irrigate immediately after manuring.

Note: For Nendran, apply the fertilizers in six split doses as detailed below which will be beneficial to improve the finger size and bunch weight, provided the farmers can afford the cost of application.

Time of fertilizer application	N:P <sub>2</sub> O <sub>5</sub> :K <sub>2</sub> O g/plant
One month after planting	40:65:60
Two months after planting	30:50:60
Three months after planting	30:00:60
Four months after planting	30:00:60
Five months after planting	30:00:60
Just after complete emergence of bunch	30:00:00
Total	190:115:300

In Onattukara, for Njalipoovan, apply N, P<sub>2</sub>O<sub>5</sub> and K<sub>2</sub>O @ 200:200:400g/plant/year in two equal split doses: the first, two months after planting and the second, four months after planting.

For Palayankodan (rainfed), planting may

be done in January and the suckers may be given pot irrigation @ 9 litres of water once in 15 days until April-May.

After planting banana, sow sun hemp / daincha / cowpea adopting a seed rate of 50 kg ha<sup>-1</sup>. Incorporate the crop into the soil 40 days after sowing. Repeat sowing of green manure crop and incorporate into soil 40 days after sowing.

Incorporation of cowpea in the inter-spaces of banana cv. Nendran with 75 per cent recommended dose of fertilizer (143:85:225 g N: P<sub>2</sub>O<sub>5</sub>: K<sub>2</sub>O /plant) can be done as INM practice for highest BC ratio.

#### Irrigation

1. During summer months, irrigate once in three days.
2. Ensure good drainage and prevent water logging.
3. About 6-10 irrigations per crop may be given depending upon soil conditions.
4. Banana var. Nendran (October planting) grown under deep water table conditions (below 2 m from ground level) needs 10 mm (40 l/plant) irrigation once in two days during summer season to ensure higher bunch yield and better water use efficiency. Mulching the basin with 3.5 kg paddy straw (waste quality) will considerably improve the bunch yield.

#### Weed control

During early stages, complete control of weeds could be obtained by raising cowpea in the interspaces. In gardens where this is not possible, pre-emergence application of diuron 1.5 kg ha<sup>-1</sup> or oxyfluorfen 0.2 kg ha<sup>-1</sup> is effective. Weeds emerging later could be controlled by the application of glyphosate 0.4 kg ha<sup>-1</sup>. If hand weeding is resorted to, give 4-5 surface diggings depending on weed growth. Avoid deep digging. Do not disturb soil

after plants start producing bunches. If green manure crop is grown, weeding operations can be reduced to 1-2 diggings.

#### Desuckering

Remove side suckers produced till the emergence of bunch. Retain one or two suckers produced after the emergence of bunch.

#### Intercropping in Nendran variety

Cucumber and amaranth can be cultivated profitably with banana raised in September-October without affecting the bunch weight. For vegetable purpose, cucumber may be harvested within 95 days and for seed purpose the duration may be about 130 days. Greater yam and elephant foot yam can be profitably intercropped with Nendran.

#### Pre harvest bunch spray

Pre harvest bunch sprays of 3 per cent K<sub>2</sub>SO<sub>4</sub> (3 g in 100 ml of distilled water) twice, the first two weeks after bunch emergence and the second four weeks after bunch emergence increases the fruit yield substantially and consumer preferences in Nendran banana.

#### Tissue culture Nendran banana (Ad hoc recommendation)

Tissue culture offers a rapid method of multiplication of quality, uniform, pest and disease free production of planting materials in large quantities in banana. The productivity of banana can be increased by cultivation of tissue culture plants of selected elite ecotypes of different varieties.

#### Spacing

Give spacing of 2 m x 2 m (2500 plants/ha). Tissue culture plants can also be used for high density planting in Nendran banana to achieve higher returns. The spacing recommended for high density planting is as follows: (a) 2 m x 3 m with two plants / pit

(3332 plants in 1666 pits per ha) (b) 1.75 m x 1.75 m with one plant per pit (3265 plants / ha).

Pit size

50 cm x 50 cm x 50 cm

Method of planting

Prepare pits 15 days in advance of planting. Fill the pits with topsoil and FYM 15-20 kg per plant per pit. Plant the tissue culture plants on the top of the pit at ground level. Remove the polythene cover completely before planting without damaging the roots. Planting may be done preferably during evening hours. Provide partial shade to plants to protect against sun scorching for about two weeks. Irrigate the crop daily during initial days of establishment.

Plant protection

Adopt integrated plant protection measures to control major pests and diseases.

Manures and Fertilizers

Apply FYM @ 15-20 kg per plant and lime 1 kg per plant at the time of land preparation. Apply N:P<sub>2</sub>O<sub>5</sub>:K<sub>2</sub>O @ 300:115:450 g per plant in six split doses as shown below.

Time of application	N:P <sub>2</sub> O <sub>5</sub> :K <sub>2</sub> O g/plant
1 month after planting	50:65:65
2 months after planting	50:00:65
3 months after planting	50:50:65
4 months after planting	50:00:65
5 months after planting	50:00:65
7 <sup>th</sup> month (i.e. after bunch emergence)	50:00:125

Organic production package for Banana var. Nendran

a. Sucker treatment

 Select healthy, disease and insect free suckers

 Dip suckers in cow dung + ash slurry containing neem oil 5% to control rhizome weevil

b. Manurial practices at planting

 Neem cake @1 kg/plant

 FYM @ 10 kg/plant+10 g Azospirillum

c. Plant protection

 To control pseudostem weevil uniform spray of neem seed oil 5% +garlic to the leaf axils and pseudostem during third and fourth MAP

 Lime 500g/plant

 Sow green manure seeds around the banana sucker. *Pseudomonas fluorescens*. spray @ 2% at two MAP

Nutrient recommendation

Any of the following combinations of organic manures can be applied as two splits (planting and 3 MAP)

 FYM 28 kg/plant+ash 4kg/plant - best treatment

 Poultry manure 14 kg/plant+ash 4 kg/plant

 Coir pith compost 10 kg/plant+ash 5 kg/plant

 Vermicompost 10 kg/plant+ash 4 kg/plant

Plant protection

Pests

Banana pseudostem weevil

The weevils resemble the rhizome weevil. Adult female weevil punctures and inserts eggs into the pseudostem. Grubs emerging out feed extensively on the pseudostem and thereby the entire plant collapses.

Management

1. Field sanitation is the most important factor in the prophylactic and curative control of this pest.

2. Remove affected plants along with the rhizome in full and destroy them by burning the life stages of the insect using kerosene or by burying the material in deep pits in soil.
3. Destroy the parts of rhizome and pseudostem of harvested plants in the field as described above.
4. Remove the dry outer sheaths of the pseudostem of all infested and un-infested plants in the endemic areas and spray any of the recommended insecticides. Drenching all the leaf axils, rhizome and surrounding soil and all round the entire pseudostem inserting the nozzle through the bore holes made by the larvae if any and also within the outer sheaths by slightly raising the same at different spots is also effective. Apply quinalphos 0.05 per cent or chlorpyrifos 0.03 per cent. Repeat the treatment after 3 weeks if the infestation persists.
5. Set traps using pseudostem of approximately 0.5 m length, which are split lengthwise and laid in the field. Adults attracted to it during nights may be collected and destroyed.
6. Application of Thiamethoxam 25 WG 0.2 g/l or 1g/5l or Fipronil 0.3G 10g formulation/plant at planting followed by two applications 2 and 5 months after planting.
7. Sucker treatment with *Pseudomonas fluorescens* @ 20 g/l + Sucker treatment with entomopathogenic nematode, *Heterorhabditis bacteriophora* @ 4:infected wax moth larvae/plant at planting followed by two applications 2 and 5 months after planting.

#### Aphid

Act as vector for the transmission of the dreadful bunchy top disease in banana.

#### Spindle leaf miner

Spray dimethoate 0.05 per cent on the spindle for controlling the leaf miner:

#### Nematodes

Major species are burrowing nematode, root knot nematode, root lesion nematode and cyst nematode.

In case of severe infestation there will be severe reduction in number of leaves, total bunch weight and number of fruits.

#### Management

Pare the rhizomes and apply neem cake @ 1 kg/plant at the time of planting.

For managing nematodes paring+ banana sucker treatment with *Bacillus macerans*/*Paecilomyces lilacinus* @ 5g/sucker + pit application @ 10g/pit 45 days after planting can be recommended.

#### Diseases

##### Bunchy top disease

This is a virus disease transmitted by aphids.

#### Banana rhizome weevil

The attack by this pest is reported to be serious in all localities where banana is cultivated. Female adults puncture healthy rhizomes and insert eggs through it. Grubs tunnel into the rhizome and feed on it resulting in the stunting of rhizome. If the infestation occurs on a mature rhizome, damage symptoms such as reduction in leaf number, bunch size and the fruit number appear.

#### Management

1. Adopt strict field sanitation.
2. Select only healthy planting material.
3. Deep ploughing of the land so as to expose the inner soil layer to sun.
4. Cut and remove the outer layer of the rhizome and sundry for 3-4 days after smearing it with slurry of cowdung and ash.

### Management

1. Eradicate disease affected plants.
2. Use disease free suckers for planting. Karpooravally, Kanchikela, Njalipoovan and Koompillakannan are less susceptible varieties.
3. Use of virus indexed tissue culture plants.

### Panama wilt (*Fusarium wilt*) (*Fusarium oxysporum* f. *cubense*)

1. Dip suckers of susceptible varieties in  $2 \text{ g l}^{-1}$  carbendazim solution to prevent spread of the disease.
2. Drench the soil around affected clumps with  $2 \text{ g l}^{-1}$  carbendazim solution to prevent spread of disease.
3. Remove and destroy affected clumps along with corms.
4. Apply lime @  $1 \text{ kg pit}^{-1}$  and allow to weather. Varieties such as Palayankodan, Robusta and Nendran are resistant to the disease.

### Sigatoka leaf spot (*Mycosphaerella* sp.)

1. Cut and burn all severely affected leaves.
2. Spray 1 per cent Bordeaux mixture with sticker soon after the appearance of the initial symptoms of the disease. The disease appears with the commencement of southwest monsoon. Five to six sprayings at fortnightly intervals are to be given depending upon the severity of the disease.
3. Petroleum based mineral oil 1 per cent emulsion is also effective in controlling the disease.
4. Spray carbendazim  $1 \text{ g l}^{-1}$  or give alternate sprays of mancozeb ( $2 \text{ g l}^{-1}$ ) and carbendazim ( $1 \text{ g l}^{-1}$ ) soon after the appearance of initial symptoms of the disease. Three to four sprays at fortnightly intervals are to be given depending on the severity of disease.

5. Spraying of cow's urine (10%) / sucker treatment with *Pseudomonas fluorescens* 5% + Spraying 2% *Pseudomonas fluorescens* and vegetable oil ( $2.5 \text{ ml l}^{-1}$ ) + baking soda ( $2.5 \text{ g l}^{-1}$ ).

### Kokkan disease (Banana bract mosaic virus)

Kokkan disease was found to affect other varieties like Palayankodan, Kodappanillakunnan, Monthan, Kanchikela, Poovan (Rasthali), Karpooravally, Chenkadali and Nendran. Nendran is a highly susceptible variety.

During the young stage of Nendran banana plant (two months old), pinkish streaks can be seen on the pseudostem. All the kokkan affected plants may not show this symptom. Necrotic streaks are another important symptom of the disease. The streaks are initially brown, which later turn black. It occurs on all aerial parts of the affected plant except on lamina, the length being a few mm to 10 cm. All the kokkan-affected plants will exhibit the necrotic streaks from third month onwards at one stage or other. Some of the affected plants retain the necrotic streaks throughout the growth period. In certain cases it disappears with the senescence of the affected portion. Leaves of the infected plants also show travellers palm like leaf arrangements.

The affected plant produces only a small bunch. The fingers are small, curved and widely divergent with pale green to ashy green colour as compared to healthy ones. The abnormal colour and reduction in the size of bunch depend upon the severity of the disease.

Suckers should not be taken from affected plants, which show necrotic streaks or abnormal colour of the pseudostem. When the young plants show the symptom of pinkish streaks, they should be uprooted and destroyed.

Infectious chlorosis (Cucumber mosaic virus disease)

The disease is noticed in varieties such as Nendran, Palayankodan, Karpooravally, Kosthabontha, Peykunnan, Bhimkhel, Mottapoovan, Dakshinsagar, Madhuraga, Rasthali and *Musa ornata*.

The most characteristic symptoms are the loss of leaf colour in patches, appearance of parallel chlorotic streaks on the younger leaves giving a striped appearance of the leaves. As the disease progresses, leaves emerge distorted, margins become irregularly wavy, often with blotches of necrotic tissues and the lamina is reduced in width. In severe cases, rotted areas are found throughout the leaf sheath and pseudostem. The affected plants produce only small bunches. This is a virus disease transmitted by aphids.

1. Use disease free suckers for planting.
2. Eradicate disease affected plants.
3. Avoid growing leguminous and cucurbitaceous vegetables as intercrop in banana in disease prone areas.

#### Banana streak disease

Banana streak disease is caused by Banana streak badna virus and transmitted by pineapple mealy bug (*Dysmicoccus brevipes* Cockerell) and striped mealy bug (*Ferrisia virgata* Cockerell). It is predominant on Palayankodan variety, also noticed on other varieties like Nendran, Chinali and Mottapoovan. The symptoms appear on different parts of the plant such as leaf lamina, midrib, pseudostem and on bunches. Linear chlorotic streaks appear on leaf lamina which later turned brown streaks. Such dark brown

linear lesions appear on petiole, midrib, pseudostem and bunches. Under severe conditions, necrosis and death of cigar leaf is noticed and such plants fail to flower and lead to total yield loss.

For the control of the disease, eradicate diseased plants, do not select planting materials from infected clumps. Avoid growing colocasia as intercrop and control of mealy bug vectors.

#### Process Protocol for Banana flour production

The banana powder is prepared by drying banana slices at 70°C for 24 h, which was pre-treated with 0.5% citric acid for 10 min, in a convective dryer. An ethnic health mix was also developed out of Nendran banana flour and sugar (75:25). The best proportion of Nendran banana flour and sugar were selected based on the nutritional and sensory quality parameters. The new product could be stored for more than six months using suitable packaging technology.

#### RTE Snacks from starch based food products

An extruded Ready To Eat (RTE) snack food product was developed out of starch based food products such as rice, cassava and Nendran banana at optimized process parameters viz; temperature (180°C), screw speed (100 rpm) and moisture content (16%) using a single screw extruder. The best proportion of rice: banana and cassava (10:80:10) was selected based on the nutritional, engineering, textural and sensory quality parameters. The new RTE product could be stored for more than six months using suitable packaging technology.

## GUAVA (*Psidium guajava*)

Guava thrives well in places receiving medium rainfall not exceeding 100 cm. In heavy rainfall areas, plants grow luxuriantly, but produce insipid and low quality fruits. It grows well on any type of soil. Red sandy loam soil with good drainage is the most ideal for commercial cultivation of guava.

### Varieties

Allahabad Safeda, Sardar (Lucknow-49), Red Fleshed, Apple Coloured and Pear Shaped.

### Planting material

Air layering is widely adopted for propagation of selected varieties. Layers strike roots within 3-5 weeks. When the roots grow through the ball of moss, the stem may be severed below the girdled area in stages. The polythene film is removed from the finally severed rooted stem, which is then potted and kept in the shade until new leaves appear. When the new flushes are produced, the plant can be hardened in full sunlight preparatory to transplanting in the field.

### Planting

Pits of one metre cube are made 6 m apart. Fill the pits with topsoil, sand and cowdung. Layers are planted in the centre of the pit. Staking of plants is also done, if necessary. After planting, mulching with dry leaves should be done to conserve moisture. June-July is the ideal time for planting. Plants should be irrigated in summer. Square system of planting facilitates easy orchard operations. Guava can be grown as an intercrop in coconut gardens.

### Manuring

A fully grown-up bearing plant should be manured with about 80 kg of FYM, 200 g N, 80 g  $P_2O_5$  and 260 g  $K_2O$ . These may be applied in two or three split doses when there is sufficient moisture in the soil.

### Yield

Guava layers start bearing from 3-4 years after planting. About 500-800 fruits per year can be obtained from a 10 year old tree.

### Plant protection

#### Fruit rot disease

This is a serious disease of guava especially during rainy season. The symptoms are manifested as development of dark brown circular spots at the blossom end of the immature green fruits.

#### Guava wilt

In affected trees, the branches wither and die one after another and in a few weeks or months the tree, which seemed entirely healthy will be dead. Remove such trees as soon as the symptoms are identified to prevent the spread of the disease.

#### Fruit fly

This is a serious pest of guava. The insect affects the fruit when it matures. The infested fruits show depression with dark green punctures. As a precautionary measure, the crop should be sprayed just before fruit maturity with dimethoate (0.05 per cent).

## INDIAN GOOSEBERRY (*Phyllanthus emblica*)

Indian Gooseberry/Emblica/Nelli is quite hardy and can be grown with little care in all types of soil except very sandy type. It prefers a warm dry climate and is found in the dry deciduous forests of Kerala.

### Varieties

Much genetic variability exists in this species. However, a high yielding larger fruited variety was located from the rain shadow region of the Western Ghats and popularized as "Chambakad Large". Other varieties are Banarasi, Krishna and Kanchan.

### Cultivation

Emblica is usually propagated by seeds and vegetatively by wedge grafting. The seeds are enclosed in a hard seed coat, which renders the germination difficult. The seeds can be extracted by sun drying ripe fruits for about

2-3 days till they split open releasing the seeds. The seeds can be directly sown. Gooseberry can be vegetatively propagated through root suckers also.

One year old seedlings can be planted in the field during rainy season at a spacing of 8 m x 8 m. It can be planted as windbreak around the orchard.

No serious pests or diseases are generally found in this crop.

### Harvesting

Seedlings will commence bearing from the 10<sup>th</sup> year and the grafts in 3-4 years. The vegetative growth of the tree continues from April to July. Along with the new growth in the spring, flowering commences. Fruits will mature by January-February. Yield ranges between 30-50 kg per tree per year when full grown.

## JACK (*Artocarpus heterophyllus*)

Jack comes up well in humid regions up to an elevation of 1000 m. Soil should be deep and well drained. Any rise in water table or poor aeration of the soil is detrimental to the crop.

### Varieties / types

Jackfruit differs in size, shape and quality. The jackfruit may be classified into two groups: (i) soft fleshed (koozha) and (ii) firm fleshed (varikka). The firm fleshed type is highly tasty, sweet and crisp. The two groups are further classified depending on the taste, size of fruit, odour of flesh and also the nature, shape and diversity of prickles on the rind.

Two distinct types with desirable qualities recommended for Kerala are:

1. Muttom varikka which is a firm fleshed, sweet scented variety.
2. Singapore or Srilanka jack which is an introduced variety from Srilanka. It bears fruits in 3 years after planting and is extremely precocious in habit. The fruits are more or less the same size as the common jack fruit. A tree may yield as many as 250 fruits.
3. Sindhoor - Highly sweet variety with attractive sunset orange coloured flakes. Bear medium sized fruits (11-12 kg) twice a year.

### Planting materials

Use grafts for planting. For grafting, raise



seedlings in polythene bags and when they are 9-12 months old, do inarching. One month after grafting, behead the rootstock above the graft joint.

Epicotyl grafting can be undertaken successfully in jack. Three to four month old, 10 cm long scions are grafted on five days old rootstocks in polythene bags by the cleft method during the month of June and keep under moist conditions. The scions should be pre-cured 10 days before grafting by clipping the leaf blades and keeping the petioles intact on the twig. The graft union establishes by 80 days after grafting operations.

A new method of approach grafting utilizing sprouted jack seedlings (maximum 20 days old) as root stock and tender shoot tips of 2 to 3 weeks old with one or two tender leaves as scion is successful, fast and cost affective.

#### Season

Plant one year old grafts at the onset of monsoon showers.

#### Planting

Prepare pits of size 60 cm x 60 cm x 60 cm at a spacing of 12-15 m. Fill pits with mixture of topsoil and 10 kg compost or FYM per pit to a level higher than the adjoining ground. Plant the grafts in the same depth as they were in the containers, preferably in the late evening. Deep planting results in poor growth of the graft. Ensure that the graft joint is above the soil level. Stake the plants to prevent snapping at the graft joints. Excellent drainage and adequate watering result in better performance. At no stage it should be exposed to drought or frost. It is useful to provide some

protection, especially to young trees. Jack is rarely manured. Even without fertilizer application, the jack trees come up well under Kerala conditions.

#### Harvesting

The seedlings generally bear after eight years and the grafted plants after three years of planting. The fruiting season lasts about four months from January-February to May-June. The average yield from one tree is about 50-100 fruits per year.

#### Plant protection

The important pests of jack are shoot borer caterpillar, mealy bug and jack scale.

The common diseases that attack the tree are the pink disease, stem rot and fruit rot. Pruning of affected plants and protecting the cut ends with Bordeaux paste are recommended against these diseases.

#### Ready to cook tender jack fruit

A process protocol developed for canning of tender jack fruit involves treatment combinations like blanching process, thermal processing parameters viz; time, temperature and preservatives were optimized based on the quality analysis and shelf life studies. The study concluded that the samples which were blanched for one minute at 100°C and pasteurized at 90°C for F value 10 were found to be superior. A shelf life of 2 years could be achieved for pasteurised and sterilised tender jack fruit at refrigerated storage and ambient condition respectively, using this new technology. The product resembled the fresh sample, available to the consumers in a ready to cook form throughout the year.

## MANDARIN ORANGE (*Citrus reticulata*)

Mandarin orange is a subtropical fruit growing in the high ranges of Kerala. It requires deep soil rich in humus. The crop cannot withstand waterlogging. It is grown in regions having good drainage.

### Preparation of land

Dig pits of size 70 cm x 60 cm x 70 cm at a spacing of 7-8 m at least one month in advance of planting.

### Planting material

Use budded plants for planting. For raising seedlings, extract seeds from selected fruits by squeezing. Wash the seeds free of pulp and dry them. Make seedbeds 1.5 m long, 1 m wide and 15 cm height. Sow the seeds giving a spacing of 13 cm in a row and 3 cm between the rows. Thin the seedlings if necessary or plant selected seedlings in secondary nursery. For budding, use rough lemon (*jambhiri*) seedlings as rootstock. Raise the rootstock seedlings in a nursery and when they are 18-24 months old, budding may be done by the inverted "T" method. The best time for budding is from July to September. A month after insertion, lop off the vegetative growth of the seedling above the bud joint completely. The budded plants are ready for planting in 6-12 months.

### Time and method for planting

Planting is done during July-August. Lift the plants carefully with a ball of earth around the roots and plant them carefully without disturbing the roots. While planting, remove the bandage around the bud joint and keep the bud joint at least 10-15 cm above soil surface. Remove the vegetative growth arising below the bud union periodically.

### Manuring

The manuring schedule recommended is given below.

Time after planting	FYM kg/plant	N:P <sub>2</sub> O <sub>5</sub> :K <sub>2</sub> O g/plant/year
1 <sup>st</sup> year	2	40:20:25
2 <sup>nd</sup> year	4	80:35:50
3 <sup>rd</sup> year	6	160:75:100
4 <sup>th</sup> year	8	300:100:150
5 <sup>th</sup> year	10	600:175:300
6 <sup>th</sup> year	10	800:275:750
7 <sup>th</sup> year onwards	10	800:275:1000

Apply organic manure in May and fertilizers in two equal split doses during June-July and in September-October. In addition to the above manures and fertilizers, spray micronutrients such as zinc sulphate 500 g, copper sulphate 500 g, manganese sulphate 300 g and lime 500 g in 100 litres of water per ha twice in a year during March and October-November.

### After cultivation

Give a light digging or ploughing when the rains start.

### Pruning

In the early stages, give some formative pruning to establish a strong framework. Remove all shoots arising from rootstock below the bud union. Remove dead branches and smear the cut ends with Bordeaux paste. Do not prune the roots.

### Intercropping

Crops like coffee, cardamom, banana and pineapple can be planted as intercrops depending on soil fertility status.

### Plant protection

For controlling citrus butterfly, hand picking of caterpillars and spraying with a contact insecticide are to be done.

To control stem borer incidence, chip off the affected new shoots inject 1 per cent dichlorvos into the tunnels. To control aphids apply dimethoate 0.05 per cent.

Stem borers (*Chelidonium* sp., *Chloridolum* sp. and *Nupserha* sp.) cause withering of branches. Gum exudes from holes on stems and branches. Accumulation of wood dust on ground around the base is another symptom of borer damage.

Cutting and burning of the affected branches and injecting petrol during May is recommended against the borers.

Among diseases, dieback, root and collar rot are important. Periodical removal of dried twigs and application of Bordeaux paste on cut ends and application of Bordeaux mixture 1 per cent can control dieback disease.

Against root and collar rot, removal of soil from the base of the trunk, scraping of the dead bark and application of lime sulphur are to be done. As an alternative, smear Bordeaux paste over the treated roots and stem. Exposing the main roots to a depth of about 30 cm is also advised.

## MANGO (*Mangifera indica*)

Mango is adaptable to a wide range of climate and soil conditions and grows well from sea level up to about 1500 m above mean sea level. It withstands both fairly dry conditions and heavy rainfall.

### Varieties

Alphonso, Kalapady, Neelum, Mundappa, Pairi, Baneshan, Alampur Baneshan, Mulgoa, Suvamarekha, Bangalora, Bennet Alphonso (Sindhuram), Prior (Priyur), Muvandan, Vellaikolamban (Kolambu mavu), Chandrakaran (Juicy/suitable for tender mango pickle).

### Hybrids

Hybrid No.45 (Bennet Alphonso x Himayuddin), Hybrid No.87 (Kalapady x Alampur Baneshan), Hybrid No.151 (Kalapady x Neelum), Ratna.

### Season

Plant one year old grafts with the onset of monsoon showers so that they get established before the rains. If rainfall is heavy, planting should be done during August-September.

### Vegetative propagation

Stone grafting is successful in mango. August is ideal for the operation. Select four month old scion materials. Defoliation of scion shoots 10 days prior to grafting is beneficial. Grafting of 8 cm long scion on rootstocks at a height of 6 to 8 cm is most successful. The dieback disease of grafts caused by *Colletotrichum* can be controlled by spraying 1 per cent Bordeaux mixture.

### Planting

Select good grafts for planting. Planting can be done in square system or hexagonal system. Prepare pits of size 1 m x 1 m x 1 m at a spacing of 9 m, one month before planting and allow to weather. Refill pits with mixture of topsoil and 10 kg of compost or FYM per pit to a level higher than the adjoining ground. Plant the grafts at the same depths as they were in the containers, preferably in the late evening. Deep planting results in poor growth of the plant. Ensure that the graft joint is above the soil level. Tie the plants to stakes

to prevent snapping at the graft joints.

#### Manuring

Apply FYM/compost and fertilizers at the rate indicated below:

Age of plant	FYM kg/plant/year	N:P <sub>2</sub> O <sub>5</sub> :K <sub>2</sub> O (g/plant/year)
1 <sup>st</sup> year	10	20:18:50
2 <sup>nd</sup> year	15	50:27:75
3-5 years	25	100:36:100
6-7 years	40	250:172:200
8-10 years	50	400:144:400
Over 10 years	75	500:360:750

Green leaves (25 kg/plant) and wood ash (10-15 kg/plant) may be applied additionally. Apply organic manures in May-June with the onset of monsoon. Apply the fertilizers in one dose during May-June until bearing stage and thereafter in two equal split doses, the first during May-June and the second during August-September. Apply manures and fertilizers in trenches 30 cm deep taken at a distance of 2.5 to 3 m from the base of the tree.

Induction of flowering and improvement of yield in adult mango trees (> 15 years old)

Apply Paclobutrazol @ 5.0 g / tree,

Time of application: September avoiding rainy periods

Method of application: Dilute in 10 litres of water and drench soil at about 60 cm away from tree trunk.

#### Precautions

- i) Soil should be wet at the time of application.

- ii) Keep the soil moist by watering at an interval of 15-20 days.

- iii) Proper management practices should be followed to maintain the health of the trees.

#### After cultivation

Base banding technique for Loranthus management: To manage the mistletoes in mangoes, base banding with a strip of cotton cloth (20cm long, 1cm width) soaked in 2% 2,4-D on a fresh wound, either on the root system or lower most portion of the parasite stem will be effective.

Irrigate twice a week during summer months till the plants are 4-5 years old. Grow vegetables, horse gram, black gram, pineapple and banana as intercrops in young orchards. Carry out intercultural operations by ploughing or digging twice during the year in June and October. For reducing fruit drop and to improve productivity, NAA at 10-30 ppm concentration may be sprayed to the entire inflorescence at the peak stage in the second week after fruit set.

#### Plant protection

Base banding technique for Loranthus management: To manage the mistletoes in mangoes, base banding with a strip of cotton cloth (20 cm long, 1cm width) soaked in 2% 2,4-D on a fresh wound, either on the root system or lower most portion of the parasite stem will be effective.

The important pests of mango are hoppers, stem borers, shoot midges, leaf feeding insects, fruit flies and psyllids. The common diseases are the powdery mildew, anthracnose and dieback. To control mango hopper spray malathion 0.1 per cent at the time of flowering. To control mango stem borer, apply paste made of crude carbolic acid (130 ml), soft soap (1 kg) and hot water (3.7 litres)

to holes in the bark and plug the holes. To control fruit fly, spray malathion 0.1 per cent emulsion / suspension containing 2 per cent sugar. Collect and destroy attacked fruits that rot and drop down. Fruit flies can be effectively managed by keeping Ocimum trap @ 4/tree and collection and destruction of fallen fruits by taking deep pits having at least 60 cm depth, setting up of Pheromone trap (methyl eugenol trap) @ 1 trap per 15 cents, swabbing the tree trunk with jaggery 10% containing malathion 0.1% @ 1 litre/tree during fruiting season at fortnightly intervals, soil application of

*B. bassiana* formulation @ 10 litre solution / 40m<sup>2</sup> under tree canopy (containing 20 g formulation/litre) during fruiting season and post harvest treatment of harvested fruits with luke warm water (48°C) containing 1% salt for 15 minutes is recommended.

To control shoot midge, which causes the drying of tender shoots, spray dimethoate 0.05 per cent. Apply wettable sulphur for the control of powdery mildew. To control dieback of twigs and branches, cut the affected twigs below the infected region and apply Bordeaux paste to the cut ends.

## PAPAYA (*Carica papaya*)

Papaya thrives well in tropical climate. The occurrence of low temperature and frost limits its cultivation. The optimum temperature for the growth and development of papaya is 22-26°C. In Kerala, the limiting factors for commercial cultivation are high rainfall and severe drought in summer. However, this is best suited as a homestead fruit crop. The papaya prefers a rich, well-drained soil. It will not tolerate water logging around the trunk.

### Varieties

Washington, Honey Dew, Coorg Honey Dew, Solo, Pusa Dwarf, Surya, Co-7, Pusa Nanha, Pusa Giant; Co-2 and Co-5 are suitable for papain extraction.

### Propagation

Papaya is propagated almost entirely by seeds. The best time for raising papaya seedlings is from February to March. The seeds are sown in raised seedbeds of 2 m x 1 m made 15 cm above the ground level or in polythene bags. A mixture of sand, leaf mould and dried FYM is spread over the seedbed. The seeds are sown 2-3 cm deep at a distance

of 5 cm in rows 15 cm apart. To raise seedlings for planting in a hectare, 250 g seeds are required. Seed beds should be watered daily, if there is no rain.

Papaya seedlings raised in polythene bags can stand transplanting better than that raised in seedbeds. Polythene bags of 20 cm x 15 cm size and 150 gauge thickness are used as containers. They are filled with a mixture of FYM, soil and sand in equal proportions. Two seeds are sown in each bag and after germination, only one seedling is retained. Vegetative propagation by mound layering is also possible.

### Planting

Two months old seedlings are transplanted in the main field in May-June at a spacing of 2 m x 2 m. Pits of size 50 cm x 50 cm x 50 cm are taken and filled with topsoil. Male plants are removed as soon as they flower and the female and hermaphrodite plants are retained. In pure female plantations, one male plant is retained for every 10 female plants. Seedlings are shaded to protect them from

excessive sunlight until they establish. In hermaphrodite or monoecious types male plants may not be required.

#### Manuring

Organic manure may be applied @10 to 25 kg/plant/year at the onset of southwest monsoon in basins around the plant. Each papaya plant should also be supplied with 40 g N, 40 g P<sub>2</sub>O<sub>5</sub> and 80 g K<sub>2</sub>O at bimonthly interval.

#### Intercultivation and intercropping

Keep the papaya plot free of weeds. Two hand diggings, one in the beginning of the rainy season and another in January-February are necessary. When papaya is grown as the main crop, vegetables can be profitably cultivated as intercrop for about six months from planting of papaya seedlings.

#### Irrigation

The crop should be irrigated in summer. The ring system of irrigation is better for papaya than the basin system because the ring system prevents irrigation water coming into contact with the stem, thus preventing collar rot.

#### Harvesting

The seedlings flower and set fruit within 3-5 months after transplanting. The number of fruits harvested per tree per year varies from 25 to 30. Fruits showing streaks of yellow colour are harvested. Although papaya trees bear flowers and fruits continuously for many years, it is not economical to retain the trees after 2.5 to 3 years.

#### Extraction of papain

Papain is an active enzyme present in the latex or milky secretion of papaya plants and immature fruits. Half to three-fourth matured fruits (about 70 to 100 days from fruit set) are

preferred for papain extraction. Tapping of fruits can be done early in the morning by giving longitudinal skin depth incisions (3 mm) on the surface of the fruits from the stalk end to tip. Stainless steel blades or knives or bamboo splinters are used for incising papaya fruits. The milky latex is collected in arecanut spathes or aluminium or glass vessels. The incisions are repeated in two or three subsequent occasions at 3 to 4 days intervals. The latex collected in this way is dried in the sun or in an artificial drier at 50-55°C. A small quantity of potassium metabisulphite is added to the liquid latex to extend the storage life of papain. The dried latex can be stored in airtight polythene or glass containers for a period of six months. Tapped fruits are equally tasty as untapped fruits, although impaired in appearance.

#### Plant protection

##### Papaya mealy bug

Bio-control of papaya mealy bug using parasitoid - See page 332.

##### Damping off

It causes rotting of seedlings in the nursery. This can be prevented by sterilizing the soil of the seedbed with 2.5 per cent formaldehyde solution and covering it for 48 hours with polythene sheets. This treatment is given 15 days before sowing.

##### Collar rot or stem rot

Waterlogging and poor drainage are the chief contributing factors. Application of Bordeaux paste on the stem and soil drenching with Bordeaux mixture 1 per cent are control measures.

##### Anthracnose

It causes premature fruit fall and leaf fall. To control, spray 1% Bordeaux mixture. Papaya mosaic and papaya leaf curl are two serious virus diseases of papaya. Remove the affected plants and burn them immediately.

## PINEAPPLE (*Ananas comosus*)

Pineapple is mostly grown at low elevations in areas with a temperature range of 15 to 30°C. Pineapple is tolerant to drought because of the special water storage cells. They can be grown with a wide range of rainfall from 600-2500 mm/annum, the optimum being 1000-1500 mm. Pineapple can be grown in a wide range of soils, but does not tolerate waterlogging. It can be grown as a pure crop on plantation scale or as an intercrop in coconut gardens.

### Season

The planting season is May-June. Planting should be avoided during the periods of heavy rains.

### Varieties

There are three varieties viz., Kew, Amritha and Mauritius.

#### 1. KEW

Kew is a variety recommended for large scale commercial cultivation in Kerala. The Package of Practices recommendations for its cultivation is detailed below.

### Preparation of the land

Prepare the land for planting by ploughing or digging followed by levelling. Depending on the nature of land, prepare trenches of convenient length and about 90 cm width and 15-30 cm depth. The trenches are to be aligned at a distance of 165 cm from centre to centre.

### Selection and treatment of suckers

Select healthy suckers of uniform size weighing 500-1000 g. Keep suckers in open space under shade in a single layer for about 7 days for drying. Strip off a few lower old dried leaves. Allow the suckers to dry and cure for

another 7 days. Dip the cured suckers in 1 per cent Bordeaux mixture at the time of planting.

### Planting

Rake the soil and plant the suckers in double rows at spacing of 45 cm x 30 cm.

Limit the depth of planting to 7.5 to 10 cm. Adopt triangular method of planting in each trench so that the plants in two adjacent rows are not opposite to each other (plant population 40400 / ha).

### Manuring

Apply compost / cattle manure at 25 t ha<sup>-1</sup> as basal dressing. Apply fertilizers at the following dosage:

Dose	N:P <sub>2</sub> O <sub>5</sub> :K <sub>2</sub> O
Per plant per year (g)	8:4:8
Per hectare per year (kg)	320:160:320

Apply full dose of P<sub>2</sub>O<sub>5</sub> at the time of planting. Nitrogen and K<sub>2</sub>O may be applied in four splits, during May-June (at planting), August-September, November and May-June (2<sup>nd</sup> year).

Note: In places where rains are scanty during November, N and K<sub>2</sub>O may be applied in three equal splits - two doses in 1<sup>st</sup> year (May-June and August-September) and the third in May-June of the second year. After application of fertilizers, cover with soil by scraping the sides of trenches.

### Irrigation

During summer months, pineapple should be irrigated wherever possible at 0.6 IW/CPE ratio (50 mm depth of water). It requires five or six irrigations during dry months at an interval of 22 days. Mulching the crop with dry leaves at 6 t ha<sup>-1</sup> will help to conserve moisture.

### Weed control

For effective and economic weed control, use weedicides. Pre-emergent spray with diuron 3 kg or bromacil 2.5 kg in 600 litres of water per hectare completely controls all types of weeds in pineapple plantation. If there is subsequent growth of weeds, herbicide application may be repeated at half the above dose. Spraying should be done when there is adequate moisture in the soil. Avoid periods of heavy rainfall for spraying.

### Induction of flowering

For inducement of uniform flowering, apply 25 ppm ethephon (2-chloro ethyl phosphonic acid) in aqueous solution containing 2 per cent urea and 0.04 per cent calcium carbonate as follows:

The mixture (50 ml/plant) is to be applied pouring into the heart of 10-12 months old plants (39-42 leaf stage) during dry weather. For treating 1000 plants, 50 litres of the solution would be required. (The ingredients for preparing 50 litres of the aqueous solution are ethephon 1.25 ml, urea 1 kg and calcium carbonate 20 g, made up to 50 litres with water. The dosage has to be fixed depending on the availability of commercial formulation and the active ingredient contents). Fruits will be ready for harvest by 5  $\frac{1}{4}$  - 5  $\frac{3}{4}$  months after the application of growth regulator.

Flowering will commence from 40<sup>th</sup> day after application and complete by 70<sup>th</sup> day.

## 2. MAURITIUS

Mauritius is recommended for commercial cultivation for table purposes and distant marketing, due to its shorter duration, better fruit quality, keeping quality and transportability.

### Season

Main season of planting is April-May and

August-September, but can also be planted in all months except during heavy rain of June-July. The best time for planting is August. For getting maximum price and better keeping quality, the best planting time is April-May. During summer months, if there are no summer showers after planting, irrigation should be given three weeks after planting for proper establishment.

### Cropping system

Mauritius can be grown as a pure crop in garden land, reclaimed lowlands and wetlands and as an intercrop in coconut and newly planted rubber plantations. In rubber plantation, it can be grown for the first 3-4 years only.

### Land preparation

Pure crop : Prepare the land by digging the area to be planted at 90 cm width in rows/strips, leaving the interspaces undisturbed. However, ploughing can be adopted in level land. Planting is done in paired rows of 45 cm distance between rows and 30 cm between suckers. Suckers may be planted in triangular method in the paired rows. Interspace between the paired rows is kept at 150 cm. Contour planting may be adopted in sloppy areas.

Intercropping in coconut garden: Land preparation, spacing and planting are the same as described above. There can be three-paired rows in between two rows of coconut.

Intercropping in rubber plantations: System of planting is in paired rows at 45 cm x 30 cm. There will be only one paired row of pineapple in between two rows of rubber.

Cowpea, sunhemp or daincha can be sown in the interspaces and covered with soil soon



after planting the suckers. The biomass can be uprooted at flowering and applied to pineapple plots as manure. This will also help to control the weeds by smothering them up to four months.

**Wetlands / lowlands:** Pineapple is highly sensitive to water stagnation and high moisture regimes. Hence it is important to provide good drainage, if grown in wetlands. In paddy lands, pineapple is planted in paired rows at 45 cm x 30 cm spacing on ridges taken at 60-90 cm height, depending on the water table and drainage requirement. The ridges are separated by drainage channels having 60 cm width. The width of the ridges varies from 120-150 cm. Wherever water stagnation and poor drainage are expected, a wider and deeper channel is given in between ridges.

#### Selection of suckers

Suckers are selected from disease and pest free healthy plants. Suckers are to be graded into those having 500-750 g and 750-1000 g. The graded suckers are planted in different blocks or plots, to get uniformity in growth and flowering. Bigger suckers give early yield. Dipping in 1 per cent Bordeaux mixture and 0.05 per cent quinalphos will protect the suckers against diseases and pests.

**Prophylactic treatment of suckers:** A combination of Mancozeb (0.03 per cent a.i.) and Chlorpyrifos (0.05 per cent a.i.) can also be used for sucker treatment. Dipping suckers in 0.2 per cent Pseudomonas is also effective to control suckers from diseases.

#### Planting

After preliminary land preparations, planting is done in small pits of 10-15 cm depth at a spacing of 45 cm between rows and

30 cm between plants in the rows. There is no need to plant the suckers in trenches.

#### Manuring

Apply compost / FYM @ 25 t ha<sup>-1</sup> at the time of planting. Application of 10 t ha<sup>-1</sup> (250g/plant) of poultry manure or vermi-compost, or 2 t ha<sup>-1</sup> (50g/plant) of neem cake along with 2.5kg of Azospirillum (1g/plant) and 2.5kg of Phosphobactor is also equally effective. Apply fertilizers @ 8:4:8 g N:P<sub>2</sub>O<sub>5</sub>:K<sub>2</sub>O per plant per year. Full dose of P<sub>2</sub>O<sub>5</sub> is applied at the time of planting. Nitrogen and K<sub>2</sub>O are applied as four equal split doses after planting. First dose may be applied at 40-50 days after planting and thereafter at 60-70 days intervals.

#### Intercropping

Vegetables and tuber crops can be grown as rainfed intercrops. Plant ginger or coleus (in four rows at 30 cm x 30 cm spacing in raised beds) or brinjal or bhindi (in two rows at 75 cm x 60 cm spacing) in the inter space in May last week. This will help to obtain additional returns and also control weed growth.

#### Irrigation

Wherever irrigation facilities are available, providing irrigation in summer months at two weeks intervals results in good fruit size and high yield. If there is no irrigation facility, the crop should be scheduled for harvest before summer months (before March).

#### Weed control

Pre-emergence (within a few weeks after planting) spray of diuron @ 1 kg ha<sup>-1</sup> in 600 litres of water can keep the field free of weeds for about four months. For subsequent weed control, herbicide application is repeated. For controlling Mikania micrantha

(vayara valli or American valli), spot application of diuron can be adopted. Spraying should be done in moist soil, but avoid rainy periods. Weeds in interspaces can be controlled by spraying glyphosate  $0.8 \text{ kg ha}^{-1}$ . While spraying in interspaces, care should be taken that the weedicide shall not fall on pineapple plant.

#### Flower induction

For inducing uniform flowering, 25 ppm ethephon is applied on physiologically mature plants having 39-42 leaves (7-8 months after planting). The solution for application in 1000 plants is prepared by adding 1.25 ml of ethephon (3.2 ml of 39 per cent ethrel or 12.5 ml of 10 per cent ethrel), 1 kg urea and 20 g calcium carbonate to 50 litres of water. Pour 50 ml of the prepared solution to the heart of the plant during dry weather conditions (when there is no rain during the time of application).

Flowering starts by 30 days and completes within 40 days of growth regulator application. Fruits will be ready for harvest by 130-135 days after the application of growth regulator. Harvest over different months / seasons could be obtained by carefully phasing / planning the planting and growth regulator application.

#### Plant protection

Sun burn: During summer months it is necessary to protect the fruits from scorching sun by putting dried grasses, coconut or arecanut leaves.

#### Diseases

Root rot / heart rot / fruit rot caused by *Phytophthora* sp. is common in poor drainage conditions. Providing drainage is most essential. The water table should be at least 60 cm below the soil surface. Badly affected

plants should be destroyed and the remaining plants should be drenched with 1 per cent Bordeaux mixture in the soil. Leaf spot can be controlled by spraying 1 per cent Bordeaux mixture or mancozeb  $2 \text{ g l}^{-1}$ .

#### Pests

Mealy bugs (*Dysmicoccus brevipes*/*Pseudococcus bromeliae*): Spray quinalphos 0.05 per cent, chlorpyrifos 0.05 per cent or dimethoate 0.05 per cent. Care should be taken that the spray shall reach the base and also the sides of the plant. The plot should be kept weed free. For the control of mealy bugs, control of ants is a must.

Pineapple wilt associated virus is transmitted by mealy bugs (*Dysmicoccus brevipes* Cockerell). Mealy bugs are mobilized by ants. For the management of the disease, preventive methods like, destruction of diseased plants, treating suckers by dipping in chlorpyrifos 0.05 per cent before planting, keeping pineapple fields weed free and control of mealy bugs by spraying/drenching with chlorpyrifos 0.05 per cent are to be adopted.

Scale insects (*Diaspus bromeliae*): Spraying of chemicals for the control of mealy bugs, mentioned above, will be sufficient for the control of scale insects.

#### Ratoon cropping

The plant crop after harvest can be retained as ratoon crop for two more years. After the harvest of the plant crop, chopping the side leaves of the mother plant should be done for easy cultural operations. The suckers retained should be limited to one or two per mother plant. Excess suckers if any should be removed. Earthing up should be done. Other management practices are same as for the plant crop.

## SAPOTA (*Manilkara zapota*)

Sapota requires a temperature range of 11 to 34°C and an annual precipitation of 225-375 cm. It can be grown in all types of soil, but well drained soil is necessary for good growth.

### Varieties

Cricket Ball, Oval, Kalipatti, Badami, Baramasi, Calcutta Round, Pala and PKM-1

### Propagation

It is propagated through layers and grafts. *Manilkara hexandra* (khirmi) is the best rootstock for inarching sapota.

### Season

The season of planting is May-June. Planting should be avoided during the periods of heavy rains.

### Planting

Planting is done in pits of 60 cm x 60 cm x 60 cm at a square spacing of 7-8 m.

### Manuring

The recommended nutrient dosage for a full-grown sapota tree per year is:

FYM	55 kg
N:P <sub>2</sub> O <sub>5</sub> :K <sub>2</sub> O	500:360:750g

Apply FYM in May-June with the onset of monsoon. Apply the fertilizers in two equal split doses, the first during May-June and the second during August-September.

Apply the manures and fertilizers in trenches 30 cm deep taken at a distance of 1 m from the base of the tree.

### Irrigation

Irrigation may not be necessary except during the early stages and in the hot weather; but good crops can be obtained with irrigation.

### Training and pruning

No pruning is necessary; but in old trees, lower branches can be removed up to 1 m height.

### Flowering and fruiting

The tree flowers continuously in several flushes at short intervals throughout the year. But there are two seasons when flowers will be produced profusely i.e., October to November and February to March. Grafted sapota begins to bear in the third year after planting. Fruit production increases with age up to 30 years followed by a decline. Fruits mature about 4 months after flowering.

### Harvesting

Mature fruits, which are dull brown in colour, are harvested and stored for about five days before they are fully ripened for consumption. Ripe fruits can be kept for about 5 to 7 days.

## WEST INDIAN CHERRY (*Malpighia puniceifolia*)

West Indian cherry, also known as Barbados cherry is the richest source of vitamin C. It is a medium sized shrub, which thrives well in tropical climate. It is best suited as a homestead fruit crop and prefers a rich well drained soil.

### Varieties

Two distinct types are seen.

### Pink flower type

Flowers are pink and are born in clusters in leaf axils. Fruits are large in size

(about 6 g) and red coloured when ripe.

#### White flower type

Flowers are white and are borne in clusters in leaf axils. Fruits are small (about 1 g) and orange coloured when fully ripe.

#### Planting materials

West Indian cherry is usually raised from layers. Vegetative propagation by means of hardwood cuttings along with leaves is feasible, though the percentage of rooting is very low. Airlayering is highly successful when treated with IBA. Layers strike roots within 3-4 weeks. When the roots peep out through the ball of moss or coir pith, the stem may be severed in stages. The rooted layer is potted after removing the polythene film and kept in shade till new flushes appear. Plants may be hardened in full sunlight prior to transplanting. Chip budding, shield budding, side grafting and veneer grafting are also successful to a limited extent.

#### Planting

For planting, pits of size 0.5 m x 0.5 m x 0.5 m are made, 6 m apart. Fill the pit with topsoil and 10 kg cowdung. After planting, mulching may be done with dry leaves to conserve moisture. July to December is considered to be the best time for planting. Irrigation once in four days during early stages of growth up to one year of planting and later on, once in 7-10 days is necessary.

#### Manuring

A fully grown, bearing plant should be top

dressed with fertilizers @ 100 g N, 160 g P<sub>2</sub>O<sub>5</sub> and 260 g K<sub>2</sub>O. These may be applied in two splits, in June-July and again in January, when there is sufficient moisture in the soil.

#### Pruning

Pruning is done once in a year to maintain regular shape. Pruning consists of removal of dried and diseased wood and also the drooping branches.

#### Flowering, fruiting and harvesting

Rooted cuttings and layers flower in six months. Flowering commences in the middle of May and extends up to August. The harvest of fruits commences from August and continues up to November. Rarely, flowering is noticed in March and the crop comes to harvest in April / May.

#### Yield

The average yield during fourth year is 2 kg per plant.

#### Processing

The fruits may be consumed fresh or its pulp can be used for preparation of juice, jam, jelly, preserve, syrup etc. The juice or pulp may also be used to fortify ascorbic acid content of various other products. Its juice can be used to blend with other fruit juices to give delicious mixed fruit cocktails and also to improve their nutritive value. As the richest natural source of vitamin C.

## APPLE (*Malus sylvestris*)

Apple is an important temperate fruit suited for growing in the high ranges of Kerala. Sloping sites to allow free drainage are considered more suitable than level tops. The ideal soil types are loam, sandy loam and silt loam with open porous and well-drained subsoil.

#### Preparation of land

The planting distance in India varies from 7-10 m, depending upon the vigour of plant. The pit should be of 1 m wide and 20 cm deep so that all roots may be accommodated in a well spread condition.

### Planting material

Apples are ordinarily propagated by budding or grafting on seedlings of Crab apple, Yellow Newton or Golden Delicious. Winters are best for whip grafting. Shield budding is done in June with the season's bud. Both whip grafting and shield budding are widely practiced in India. Low chilling varieties are suitable for Kerala.

### Time and method of planting

Apples are planted in the ground free of weeds. Regularly irrigated for about two years in the beginning. Planting is done late in winter. For adequate root development a temperature of 7°C is considered ideal.

### Pruning

Pruning and training are important in apple cultivation. One year old plants are cut back at about 80-100 cm above ground. If branches are present at this time, only 4 to 5 of them ought to be retained and shortened in length. No shoot is retained upto 50 cm from ground. At the time of first dormant pruning, the main scaffold branches are cut back to about half a metre in length.

Secondary branches arise from these main limbs. Some of the new shoots arising early in the second summer are rubbed off in order to develop only a few vigorous

secondary branches. During the second dormant pruning, the crowded, misplaced or diseased secondary branches are removed and the extra vigorous ones headed back. This process is continued for 4 or 5 years, at the end of which there are 8 to 10 scaffold branches.

It is desirable to add 100-150 g of nitrogen as sulphate of ammonia. Similar quantities of phosphate and potash should be added when required. Five quintals of bone meal and 10 quintals of wood ash per hectare are given annually besides the fertilizers. Fertilizers should be mixed with the soil at a radius of 1 m from the plant.

### Thinning of fruit

Thinning of fruit is also practised in order to improve fruit colour and fruit size. It is desirable to retain one fruit for every 40 leaves. This spaces the fruit at about 15-20 cm apart and there will be only one fruit per spur.

### Harvesting

Much of the success in apple production depends on proper picking, storage and disposal. When a fruit separates easily from the spur, firmness of flesh and taste are desirable. The harvested fruits may be stored for 120-150 days at 4-5°C, provided there is good circulation of air.

## ORNAMENTAL PLANTS

### ANTHURIUM (*Anthurium* spp.)

Anthurium is one of the important economic flowers of export potential. There are more than 500 species and several varieties. Few of them are commercially important.

*Anthurium andreanum*, is economically cultivated for cut flowers. They are partially epiphytic in growth habit. Plants prefer to grow under shade. The tolerable level of light in the tropical region during summer is 20-30 per cent. Excess light causes yellowing and scorching of leaves. Very low light intensity causes excessive vegetative growth and low flowering. It is preferable to grow anthurium in the open, under artificial shade structures for better growth and yield. Plant prefers to grow under a relative humidity of not less than 60 per cent and a temperature of not more than 18-28°C.

#### Propagation

Anthurium is multiplied by seed and vegetatively by stem cuttings or by separation of basal sprouts. Propagation by seed is not recommended as a commercial propagation method as it results in high variability. Plants can be multiplied in large number by micro-propagation techniques from the tender leaf bits.

#### Varieties

The economic varieties suitable for Kerala condition are Lima White, Cuba, Agnihotri, Liver Red, Can Can, Tropical, Nitta, Sunburst, Linda-de-Mol, Tinora, Acropolis, Gino Orange and Midori.

#### Planting and after care

Plants are propagated vegetatively by

separating suckers from flowering plants as and when available and planted in the medium. Cutting the thick main stem into 3-4 cm long discs and then into vertical bits can also be done. Each bit should have minimum two lateral buds. Cut-pieces are treated with a fungicide solution and planted on a medium of clean river sand. Cuttings will take 1-2 months for sprouting.

Seedlings and sprouted cuttings of 5-10 cm height are transferred to the main field or pots. Planting in pots is preferred in the plains. Cultivation in beds is good at higher altitudes (about 1000 m above MSL). A loose medium above the ground is suitable for anthurium. Old and chopped coconut husk (3 cm size) mixed with brick pieces and charcoal are filled in narrow trenches 10 cm below and above ground level.

Pots can also be filled with the same mixture. An ideal pot should be 30 cm diameter at top with 3 large holes at the bottom on sides. One plant can be planted in a pot. On ground, the spacing is 45 to 60 cm depending upon the variety. Fresh cowdung or neem cake mixed with 10-15 times of water, kept for 4-5 days, can be sprayed on the plants after filtering. Cow's urine can be sprayed or drenched after mixing with 25 times of water. Water soluble fertilizer (19:19:19) 2 g / l is applied in the medium once a week. Slow release fertilizers, if used, need be given only once in 2-3 months. Pruning of older leaves, removal of suckers at young stage, cleaning of crown before rains etc. are other operations to be carried out in order to have a better growth and flowering.

## Plant protection

### Diseases

The two major diseases are bacterial blight and anthracnose. Blackening of the stem and decay of leaf axils are the symptoms of bacterial blight. Spraying a mixture of turmeric powder and sodium bicarbonate in the proportion 10:1 @ 0.15 per cent at weekly interval from the initiation of the disease is effective for the management of bacterial blight of anthurium.

Tiny circular black spots appear on leaf and spadix in case of anthracnose. Spraying mancozeb 0.3 per cent or carbendazim 0.05 per cent can control the disease.

Root rot caused by *Pythium* and *Phytophthora* can be controlled by the application of potassium phosphonate 0.3 per cent.

### Pests

The major pests are scales and bugs, which are controlled by spraying malathion @ 2 ml per litre of water. Snails also cause damage to young roots. Use of metaldehyde can prevent the attack of snails.

### Harvesting

The flowers are harvested with its long stem when 1/4<sup>th</sup> to 3/4<sup>th</sup> flowers on the spadix are open, indicated by the change of colour. Colour change varies with the varieties.

## ORCHIDS

Orchids are noted for their bewitchingly beautiful, long lasting flowers, widely differing in shape, size and colour. They belong to the family Orchidaceae, reported to comprise over 600 genera, 30000 species and about 1.5 lakhs man made hybrids. They have varying habitats but epiphytic orchids dominate the trade. They are also classed as monopodials (stems having a vertical growth, nonbranching, with aerial roots) and sympodials (stems having a horizontal growth, producing pseudobulbs in clusters, no aerial roots).

The ideal location for orchid growing is in the open conditions, under appropriate level of shade. In Kerala certain orchids are grown under the shade of old coconut trees.

Most attractive orchids belong to the group of epiphytes, which require free moving air at all times. They produce aerial roots, which absorb water and nutrients from

the atmosphere. Both terrestrial and epiphytes grow under varying levels of shade. Plants grown under deep shade will have good vegetative growth and poor flowering. Hence shade and light regulations are very important operations for better flowering. A humid and warm atmosphere is congenial for the growth of most of the tropical orchids. Better results are obtained when the atmospheric humidity is 50 to 80 per cent. Orchids require proper temperature for good growth and flowering. Accordingly there are tropical, subtropical and temperate orchids.

### Genera/varieties

The popular genera of orchids that are suitable for growing in Kerala are *Arachnis*, *Aranthera*, *Vanda*, *Phalaenopsis* (monopodials); *Aranda*, *Mokara* (inter-generic monopodials); *Dendrobium*, *Cattleya*, *Oncidium* (sympodials).

Dendrobium is the most popular genus of Kerala. Some of the important varieties belonging to this genus are given below, grouped according to colour:

Purple and white: Sonia 17, Sonia 28, Sonia Bom Jo and Earsakul

Purple: Renappa, New Wanee, Sabine Red, Julie Red, Master Delight and Velvet Soft

White: Emma White, Fairy White, Kasem White and Snow White

Pink: Sakura Pink, New Pink, Lemon Glow and Pink Cascade

Yellow: Sherifa Fatimah, Kasem Gold and Tongchai Gold

Magenta: Deep Blush

#### Propagation

The conventional method of propagation is by vegetative means. Monopodial orchids are propagated by stem cuttings. Terminal cuttings with one or two healthy aerial roots are ideal as planting material. Basal cuttings of 30 cm length with a few roots and leaves are also good. But they take longer time to sprout and grow. Sympodial orchids are propagated by separation of pseudobulbs. A plant with minimum two or three pseudobulbs with the basal root is ideal for planting. Some of the sympodial varieties produce sprouts at the top of pseudobulb called as keikis. Keikis when fully grown can be separated and planted. Besides, back-bulbs or spent canes (shoots that have ceased to produce flowers) before they get shrivelled can be severed from the mother plant and placed horizontally over the medium to stimulate sprouting of new shoots.

Seed propagation is possible only under aseptic conditions. Seedlings produced by embryo culture will take 2-5 years for flowering, depending on the genus.

Meristem culture is very effective in large scale propagation of orchids.

#### Planting

Terminal cuttings of monopodial orchids are planted loosely on old coconut husks at a spacing of 30 cm between plants and 45 cm between rows in long beds. There can be two or three rows in a bed. Basal cuttings will sprout within a period of two months. Partial shade up to 50 per cent is required for sprouting. Basal cuttings are planted close to each other in nursery beds for sprouting. After sprouting they are planted at the recommended spacing. Monopodial orchids can be grown on ground above soil level. A thick bed of 15-20 cm height is loosely arranged. Well-dried coconut husks are better than fresh husks. Sympodial orchids are grown on benches above ground level or suspended from above. Slotted wooden baskets filled with small pieces of dried coconut husk or partially burnt charcoal is good for plant growth. Planting is done above the medium with a support for proper anchorage.

Planting can also be done in pots or other containers. Mud pots of 10-20 cm diameter with several large holes on the side and bottom, filled with tile bits, chopped coconut husk or charcoal are used for planting. A clear solution of fresh cowdung can be used for irrigation for a few days. Dipping in fresh cowdung solution before planting also gives good results.

#### Manuring

Monopodial orchids grown on ground can be given cowdung slurry once in a month. One kg fresh cowdung mixed in 5 litres of water is sufficient for one square metre. Two to three applications can be given in a year. Sympodial orchids are sprayed with the supernatant liquid of cowdung slurry. Nutrition of plants from the



natural sources is not sufficient to support the plants for economic production. Hence additional feeding is required. Foliar feeding is very effective in orchids. Fertilizer mixture of  $N:P_2O_5:K_2O$  3:1:1 can be applied during vegetative period and 1:2:2 can be applied during flowering period. The usual dose of such mixture is 2-3 g per litre of water, applied twice a week.

#### Plant protection

#### Diseases

The important fungal diseases are leaf spot, leaf blight, collar blotch, collar rot and orchid wilt.

These can be controlled by application of mancozeb, carbendazim etc. at the recommended dose. Spraying should be done prior to the commencement of monsoon and at fortnightly intervals during heavy

monsoon. Important virus diseases are mosaic and ring spot. Destroying the affected plants can control spread of these diseases.

#### Pests

The common pests attacking orchids are thrips, aphids, spider mite, soft scale, mealy bugs, orchid weevil, ants etc. Other very serious pests of orchids are snails and slugs. They feed on the tender young shoots, roots and buds. Hand-picking is effective, if the number of plants is less. They move out during late night and hide before early morning. Damage is caused during this period. All the pests can be controlled by application of contact and systemic insecticides at appropriate concentration.

#### Harvesting

The spikes are harvested before the opening of all the buds of the spike, depending on the genus.

## JASMINE (*Jasminum* spp.)

Jasmine is an important flower crop that could be grown on a commercial scale in Kerala. *Jasminum sambac* is the most ideal species for cultivation in Kerala. The flowers are used for preparing garlands. The jasmine oil has great export potential in addition to its use for medicinal purpose.

#### Important cultivars

There are trailing, climbing and erect growing species and cultivars. Three important species and their varieties are given as follows:

1. *Jasminum sambac*: Gundumalli, Motia, Virupakshi, Sujimalli, Madanabanam, Ramabanam.
2. *Jasminum grandiflorum*: Co-1 Pithi, Co-2 Pithi, Thimmapuram, Lucknow.
3. *Jasminum auriculatum*: Co-1 Mulla,

Co-2 Mulla, Long Point, Long Round, Short Point, Short Round.

#### Soil and climate

Jasmine can be planted on a wide range of soils. Well-drained sandy loams and red loams are ideal for its cultivation. In clayey soils, there is increased vegetative growth and reduced flowering. They give good yield in low rainfall conditions.

#### Propagation

Layering and cutting are the main propagation methods. Better rooting of cuttings can be obtained by planting in coarse sand and also by using any of the rooting hormones like IBA (5000 ppm), IAA (1000 ppm) and NAA (5000 ppm). Simple and compound layering methods are followed

during June-July to October-November. Layers will be ready for planting within 90-120 days.

#### Planting

After ploughing the land, pits of about 40 cm x 40 cm x 40 cm size are taken and filled with topsoil and 15 kg well rotten FYM. Planting distance depends on the species as given in table below and also on soil and environmental conditions.

Species	Planting distance
J. sambac	1.2 m x 1.2 m
J. auriculatum	1.8 m x 1.8 m
J. grandiflorum	2.0 m x 1.5 m

Planting is usually done during June-August.

#### Manuring

Each plant requires a fertilizer dose of 120 g N, 240 g P<sub>2</sub>O<sub>5</sub> and 240 g K<sub>2</sub>O. The fertilizers are mixed together and applied in two split doses during January and July. This has to be supplemented with organic manures like neem cake, groundnut oil cake etc. @ 100 g per plant per month.

#### Pruning

Pruning is essential and is done at a height of 45 cm from the ground level during mid

December-January.

#### Weed control

Manual weeding is usually done which is effective but expensive. Mulching also reduces weed population.

#### Irrigation

Constant and adequate water supply during peak flowering season (March-October) is essential for high yield of flowers. After flowering is over, water supply can be cut off. During summer, irrigate twice a week.

#### Diseases

Leaf blight: Can be controlled by spraying 0.2 per cent mancozeb.

Fusarium wilt: Prevented by drenching the soil with 1 per cent Bordeaux mixture.

#### Yield

Yield of flowers and jasmine oil vary according to the species and management practices as presented below.

Species	Flower yield (t ha <sup>-1</sup> )	Oil yield (kg ha <sup>-1</sup> )
J. sambac	5	15.44
J. auriculatum	5	28.00
J. grandiflorum	6	29.00

## GLADIOLUS (Gladiolus spp.)

Gladiolus is grown for its attractive flower spike having florets of huge form, dazzling colour and varying sizes, with long vase life.

#### Varieties

Friendship, Spic and Span, Mansoer Red, Dr. Fleming, Peter Pears and White

Friendship are some of the common varieties. Varieties evolved in India are Sapna, Poonam, Nazrana, Apsara, Agnirekha, Mayur, Suchithra, Manmohan, Manohar, Muktha, Archana, Arun and Shobha.

#### Soil

It can be grown in a wide range of soils,

light sandy to clay loam. Deep well-drained acidic soils with a pH of 5.5-6.5 are the best for cultivation.

#### Propagation

Gladiolus is propagated by corms and comels. Size of the corm markedly influences the growth and flowering of gladiolus. Medium and large sized corms are preferred for planting, as small corms produce only small flower spikes.

#### Planting

The land is ploughed two or three times and FYM @ 25 t ha<sup>-1</sup> is applied and mixed well with the soil. Ridges are made 20 cm apart. Fertilizer application is made @ 50:60:60 kg N:P<sub>2</sub>O<sub>5</sub>:K<sub>2</sub>O per ha. The corms are planted at a distance of 30 cm and at 5 cm depth. About one lakh plants can be accommodated in a hectare. Top dress the crop with 50 kg N, 45 days after planting and earth up. Best season for planting is September-November.

#### Irrigation

The crop has to be irrigated once in two or

three days depending upon soil and weather conditions.

#### Plant protection

Several species of aphids like green peach aphid, potato aphid and melon aphid damage developing foliage and flowers. They can be controlled by using dimethoate. Thrips and caterpillars can be controlled with dimethoate.

Brown and Fusarium wilts are the major diseases. Spraying the crop with 0.3 per cent copper oxychloride or drenching carbendazim 0.05 per cent is recommended when diseases are noticed.

#### Harvesting and yield

The plant starts flowering in 2-3 months after planting based on the variety. The entire spike along with two leaves is cut, when the basal flower bud starts opening. Nearly 2 lakh flower spikes can be obtained from one hectare.

After harvest of flowers, the plants are left undisturbed in the field. When they start yellowing, the plants are uprooted for harvest of corms and comels.

## TUBEROSE (*Poliantha tuberosa*)

Tuberose occupies a very special position among the ornamental bulbous plants because of its prettiness, elegance and fragrance. It has good economic potential for loose/cut flower trade and essential oil industry.

#### Cultivars

There are three groups of cultivars as given below:

1. Single: Flower is pure white and has only a single row of corolla segments. Cultivars are Sringar, Culcutta Single, Mexican Single and Suvama Rekha.

2. Double: Flowers are white, tinged with pinkish red. Petals are in several whorls. Cultivars are Suvasini, Culcutta Double and Pearl.

3. Semi-double: Similar to double but with only 2 to 3 rows of corolla segments.

This classification is based on floral characters.

#### Soil

Porous, well-drained sandy loam soils are best suited for tuberose cultivation.

### Propagation

Propagation is by bulbs. Boat shaped bulbs of size 2 to 3 cm are preferred for planting. About 1.25 to 1.50 lakh bulbs (800 to 900 kg) are required for planting one hectare.

### Cultural practices

Land is prepared well by ploughing two or three times. FYM @ 30 t ha<sup>-1</sup> is mixed well with soil. Best time for planting is May-July. The bulbs preferably those of size 2-5 cm or above are to be planted at a depth of 7-10 cm, with a spacing of 20 cm x 25 cm. A fertilizer dosage of 100:50:50 kg ha<sup>-1</sup> N:P<sub>2</sub>O<sub>5</sub>:K<sub>2</sub>O is recommended. Of these, half N, full P<sub>2</sub>O<sub>5</sub> and K<sub>2</sub>O are applied at the time of planting. Remaining N is applied when the flower spikes start to appear. A heavy irrigation once in 5-10 days is necessary depending upon the weather conditions. The peak flowering is between June and October.

### Ratoon crop

After the harvest of the main crop, the flower stalks are headed back and the plot is manured and irrigated. Three or four ratoon crops can be taken from single planting.

### Plant protection

Slugs and grass hoppers, which feed on the leaves and thrips which damage and cause distortion of the spikes are the major pests. Malathion is effective against these pests. No major disease is noticed.

### Harvest and yield

Tuberose is harvested by cutting the spikes from the base for table decoration or the individual flower is picked from the spike for making garlands and other floral ornaments:

The average yield of flower is as follows:	
Plant crop:	5-10 t ha <sup>-1</sup>
First ratoon:	9-12 t ha <sup>-1</sup>
Second ratoon:	4-6 t ha <sup>-1</sup>

## CROSSANDRA (*Crossandra infundibuliformis*)

Crossandra flowers are very popular for their bright orange colour, light weight and keeping quality. The flowers are of great demand for garlands and hair adornments.

### Cultivars

Yellow Orange, Lutea Yellow and Delhi (triploid) are the important varieties.

### Soil

Crossandra can be cultivated in a wide range of soils. Fertile, red loamy soils with pH range of 6.0 to 7.5 are ideal.

### Propagation

Propagation is by seeds or stem cuttings. Seedlings are ready for transplanting when they

have four or five pairs of leaves. In the case of triploid varieties like Delhi, cuttings are used. Cuttings should be transplanted when sufficient roots are developed.

### Cultural hints

The land has to be ploughed three or four times. FYM @ 25 t ha<sup>-1</sup> is incorporated and mixed well in the soil. Ridges are prepared 60 cm apart. A fertilizer dose of 33.3:60:60 kg ha<sup>-1</sup> N:P<sub>2</sub>O<sub>5</sub>:K<sub>2</sub>O is applied as basal. The seedlings or cuttings are transplanted at a spacing of 30 cm.

The crop is topdressed twice with 33.3 kg N per ha each time, the first at 3 months after transplanting and the second

8-9 months after transplanting. The application of fertilizers is to be necessarily followed by irrigation. Weeding, application of fertilizer and earthing up are combined together for easy maintenance of the crop.

#### Plant protection

Scales, plant bugs and white flies are the important insect pests, which can be controlled by phosalone (0.07 per cent).

Wilt caused by *Fusarium solani* will result in yellowing of leaves and death of the

plants. The incidence of the disease is found to be more in the presence of root lesion nematode.

#### Harvest and yield

Crossandra flowers within two to three months after planting and continues to bear flowers throughout the year with a lean production season during rainy months. Flowers are to be picked early in the morning by pulling the corolla out of the calyx. Harvesting of flowers is to be done on alternate days. The yield of flowers is about 5 t ha<sup>-1</sup>.

## MARIGOLD (*Tagetes* spp.)

Marigold is a popular annual flower that can be grown on a commercial scale. It has gained popularity on account of its easy cultivation and wide adaptability. Free flowering habit, short duration to produce marketable flowers, wide spectrum of colour, shape, size and good keeping quality make marigold an acceptable commercial crop.

#### Cultivars

There are two species of marigold, namely, African marigold (*Tagetes erecta*) and French marigold (*Tagetes patula*). Inter-specific hybrids between these two species also have been evolved, which are known as Red and Gold hybrids. Varieties under this group are Nugget, Show Boat and Red Seven Star.

#### African marigold varieties

Apricot, Primrose, Sun Giant, Guinea Gold, Fiesta, Golden Yellow, Hawaii, Crown of Gold, Honey Comb, Cupid, Pusa Narangi Gaintha and Pusa Basanti Gaintha.

#### French marigold varieties

Rusty Red, Naughty, Marietta, Flame, Star of India and Harmony.

#### Soil

A wide range of soils with good drainage is suitable for cultivation of marigold. Sandy loam soil with pH 5.6 to 6.5 is ideal.

#### Propagation

Seeds are used for raising the crop.

#### Cultural practices

Prepare nursery beds of 6 m length, 1.2 m width and 10-20 cm height. Apply 30 kg FYM along with 0.5 kg of 15:15:15 fertilizer mixture and mix them well in the soil. Sow the seeds in rows 7.5 cm apart. Cover the seeds with fine FYM and irrigate. The seedlings will be ready for transplanting within one month.

For the main-field, the land should be ploughed well and FYM @ 20 t ha<sup>-1</sup> should be incorporated to the soil. Apply a basal dose of fertilizers @ 112.5 kg N, 60 kg P<sub>2</sub>O<sub>5</sub>, and 60 kg K<sub>2</sub>O per ha. Transplant the seedlings at a spacing of 30 cm x 30 cm in case of French marigold and 45 cm x 45 cm in case of African marigold on one side of the ridge and irrigate.

Top dress the crop with 112.5 kg N per ha at the time of pinching (30-45 days after transplanting) and earth up. Pinching is done to increase the total yield. It consists of removing terminal portion of the plant 30-45 days after transplanting.

Irrigate once in 4-6 days depending upon soil moisture and weather conditions. Weeds have to be removed at monthly intervals.

#### Plant protection

Marigold is not attacked by many pests. However, flower beetles, leaf hoppers, stalk borers, mites etc. cause occasional problems. These plants are rarely attacked by

diseases. In poorly drained soils, foot rot caused by *Phytophthora* may occur. Stem rot caused by *Sclerotinia sclerotiorum* is also reported. Soil drenching with copper oxychloride 0.3 per cent is helpful in checking foot rot, while stem rot is controlled by drenching with fungicides.

#### Harvest and yield

Marigold flowers will be ready for harvest in about 2½ months time from the date of transplanting. The plant continues to bear flowers for another 2-2½ months. The flowers are harvested when they have attained full size. Harvest the flowers in the evening along with a portion of stalk. Yield of French marigold will be 8-12 t ha<sup>-1</sup> and that of African marigold 11-18 t ha<sup>-1</sup>.

## CHINA ASTER (*Callistephus chinensis*)

China aster is a free blooming, colourful annual flower. It is grown on a commercial scale in many parts of India. Bright coloured flowers of China aster are in much demand for the preparation of bouquets and flower arrangements.

#### Varieties

Ostrich Plume, Comet, Poomima, Kamini, Sasank, Violet cushion etc. are some of the commercial varieties.

#### Soil

Though it could be cultivated on a wide range of soils, well-drained red loamy soil is ideal.

#### Propagation

Commercially propagated by seeds.

#### Cultural practices

Seedlings are to be raised in nursery beds of size 7.5 m long, 1.2 m wide and 10 cm height for preparing planting materials for an area of one hectare. The seeds are sown thinly and

covered with fine FYM. The seedbeds are irrigated immediately after sowing. The seedlings will be ready for transplanting in about four weeks.

For transplanting, prepare the main field by ploughing land three or four times. FYM is applied @ 10-15 t ha<sup>-1</sup> and mixed well with the soil. Chemical fertilizers @ 90 kg N, 120 kg P<sub>2</sub>O<sub>5</sub> and 60 kg K<sub>2</sub>O per ha are required as basal dose. Seedlings of 4 weeks are transplanted at a spacing of 30 cm x 30 cm. The crop has to be top dressed with 50 kg N at 40 days of transplanting. The crop has to be irrigated once in 4-5 days depending upon the soil and weather conditions. Earthing up has to be done twice at 30 days intervals.

#### Harvest and yield

China aster blossoms will be ready for harvest within 10-12 weeks of transplanting. Generally the entire plant is harvested when most of the flowers in the plant are opened and made into bundles of 10-12 each. The yield will be 10-12 t ha<sup>-1</sup>.

## MEDICINAL AND AROMATIC PLANTS

### EUCALYPTUS (*Eucalyptus citriodora*)

Eucalyptus thrives both in the tropics and subtropics. High humidity and plenty of rainfall are conducive to its luxuriant growth. It can be grown in varied types of soils. The essential oil is used in the preparation of cosmetics, hair oil and soap.

#### Preparation of land

Clear the land of jungle growth. Take pits of size 45 cm x 45 cm x 45 cm at a spacing 2 m x 2 m at least one month prior to planting and allow to weather. Fill up the pits with soil completely so as to prevent water stagnation.

#### Planting

Nursery is raised and 4-5 months old seedlings are planted with the commencement of southwest monsoon. After planting, press the soil around the seedling and form mound to prevent stagnation of water.

#### Manuring

Manuring is not usually done. However, application of 400 g ammonium sulphate, 60 g superphosphate and 25 g muriate of potash per plant per year during August from

third year onwards is found to be useful in increasing leaf yield.

#### After cultivation

During first year, cultivate the rows in both directions to prevent weed growth. Hand weeding is done around the seedlings. Fire belts are to be provided all around.

#### Intercropping

Eucalyptus can be grown along with coffee, lemongrass and palmarosa. In the first four years, intercropping with pineapple, yam and vegetables can be done.

#### Harvest and curing

Pruning of side branches may be started from second year onwards. Lopping at a height of 2 m is done during third or fourth year and thereafter lopping is resorted to at half-yearly intervals leaving only one branch. For extracting oil, steam distillation is resorted to. Optimum time for distillation is two hours and the average recovery of oil is 1.5 - 1.8 per cent of the net weight of leaves. Wilting of the cut leaves under shade for 24 hours before distillation will increase the oil recovery percentage.

### KACHOLAM (*Kaempferia galanga*)

An attractive medicinal plant used in various medicines. The aromatic essential oil of the rhizome is widely used in perfumery, as a condiment and as a folk medicine. Asians employ the rhizomes and leaves as a perfume in cosmetics, hair washes and powders. Rhizomes are used to protect the clothing against insects and are chewed with betel nut.

Kacholam is a plant adapted for tropical climate. Fertile loamy soil having good drainage is ideal for the crop. Laterite soil with heavy organic manure application is also well suited.

#### Preparation of land

Prepare the land to a good tilth during March by ploughing or digging. On receipt of

pre-monsoon showers in April, prepare beds of 1 m width 25 cm height and of convenient length with spacing of 40 cm between beds.

#### Seed materials

Whole or split rhizome with at least one healthy sprout is the planting material in kacholam. Select well developed healthy and disease free rhizomes. Rhizomes can be stored in cool dry place or pits dug under shade, plastered with mud or cowdung. Two weeks before planting of the new crop, smoking the rhizomes by spreading it on *Glycosmis pentaphylla* (panal) leaves is practised in certain localities.

#### Varieties

Rajani and Kasthuri are high yielding varieties with an yield potential of more than 2 tonnes dry rhizomes per ha and have good aroma and flavour. Local types are also under cultivation.

#### Season and method of planting

Planting is done during the month of May with the receipt of pre-monsoon showers. Take small pits in the beds in rows with a spacing of 20 cm x 15 cm and at a depth of 4-5 cm and plant rhizomes with at least one viable healthy bud facing upwards. Adopt seed rate of 700-800 kg ha<sup>-1</sup>.

#### Manuring

Apply FYM or compost as basal dose @ 20 t ha<sup>-1</sup>, either by broadcasting and ploughing or by covering the rhizome in pits after planting. Apply N, P<sub>2</sub>O<sub>5</sub> and K<sub>2</sub>O @ 50, 50 and 50 kg ha<sup>-1</sup> at the time of the first and second weeding.

#### Mulching

After planting, mulch the beds with dry or

green leaves @ 15 t ha<sup>-1</sup>.

#### After cultivation

Remove weeds as and when necessary. Apply fertilizers and earth up the crop during the first and second weeding (45 and 90 days after planting). Avoid water stagnation in the beds. Further weeding is not necessary as the spreading leaves smother the soil surface.

#### Plant protection

During heavy rains, leaf rot disease occurs in certain localities. For controlling this disease, drench the beds with 1 per cent Bordeaux mixture or thiram 0.2 per cent.

For controlling nematodes (*Meloidogyne incognita* and *Radopholus similis*) associated with Kacholam, rhizome treatment with *Pseudomonas fluorescense* @ 3 per cent weight by weight of seed material or by green leaf mulching with neem and glyricidia @ 5kg/m<sup>2</sup> at 30 DAP can be recommended.

#### Harvesting and curing

The crop can be harvested seven months after planting. Drying of the leaves is the indication of crop maturity for harvest. Harvest the crop carefully without damaging the rhizomes, remove dried leaves and roots, wash the rhizome in water and dry. With sharp knife, chop the rhizomes into circular pieces of uniform size except the end portion, which has to be cut separately. Spread the cut rhizomes uniformly on clean floor and allow drying for four days. On fourth day, heap the rhizomes and keep it overnight. On the next day it is again spread and dried. Clean the dried produce, bag and store in cool dry place or market it. Prolonged storage can cause insect and fungus attack.



## LEMONGRASS (*Cymbopogon flexuosus*)

Lemongrass prefers warm climate with a well-distributed rainfall and well-drained soil. Usually it is grown on poor, gravelly soils. Lemongrass is a perennial grass mainly cultivated on hill slopes as a rainfed crop. The crop provides maximum yield from the second to fourth year of planting and economic yield up to the sixth year. Thereafter, the yield declines considerably. The leaves yield an aromatic oil, containing 70-90 per cent citral. The oil is used in soaps, cosmetics and disinfectants and is a raw material for manufacturing ionones and vitamin A.

### Seeds and sowing

The crop is propagated mostly through seeds. It can also be propagated vegetatively through planting of slips.

Sugandhi is the improved variety of lemongrass recommended for cultivation.

Seeds can be sown directly in the field or seedlings are raised in a nursery and then transplanted. Transplanted crop is found superior to direct-sown crop in respect of grass yield, oil content and citral content in oil. Seeds are sown in well prepared nursery beds during April-May with the onset of pre-monsoon rains and covered with thin layer of soil. The seed rate is 3 to 4 kg ha<sup>-1</sup>. Seeds collected in the season should be sown latest by August of the same year. The seedlings will be ready for transplanting in 2 to 2.5 months.

### Preparation of land

The land is prepared by digging. Raised beds of 75-80 cm width and of convenient length are formed with a spacing of 30-35 cm between beds. On sloppy terrain, the beds are formed along the contours. At the early southwest monsoon (June-July), two or three seedlings

or slips per hill are transplanted on the beds at a spacing of 15-20 cm in 4-5 rows. Before planting, the top leafy portion of the seedling is cut off leaving the plant stalk about 15-20 cm length.

### Manuring

Application of compost made of spent lemongrass (refuse obtained after distillation) and wood ash @ 2500 kg ha<sup>-1</sup> and 1875 kg ha<sup>-1</sup> respectively is found beneficial. Application of nitrogenous fertilizers @ 100 kg ha<sup>-1</sup> in four splits (each after 1<sup>st</sup> to 4<sup>th</sup> harvest) has been found to increase oil yield considerably.

### After cultivation

Regular weeding depending on weed growth and earthing up at least once in a year along with manuring is recommended. Serious pests or diseases do not generally infest the crop.

### Harvesting

Harvesting is done by cutting the grass 10 cm above ground level. During the first year of planting, three cuttings are obtained and subsequently five to six cuttings per year are taken subject to weather conditions. The harvesting season begins in May and continues till the end of January. The first harvest is taken about 90 days after planting and subsequent harvests at intervals of 40-50 days. The optimum interval between harvests to obtain maximum quantity of oil is 40-45 days for local types of lemon grass. For Sugandhi, the optimum interval was found to be 60-65 days when grown in hill tops and 45-55 days in valleys and lower areas.

### Seed collection

The crop for seed production is left without cutting to get maximum seeds. The

crop flowers during November-December and the seeds are collected during January-February. The whole panicle is cut and dried for one or two days and then threshed and sieved to collect the seeds.

#### Distillation

Essential oil from lemon grass leaves is extracted by hydro-steam distillation. Time required for distillation is two hours including the time required for charging and discharging. A light yellow, lemon scented volatile oil is obtained. When crop area is large enough, steam method is found to be more economical. Coal is used as fuel.

The cut grass is chopped into smaller pieces before feeding to the distillation unit. It can be stored up to 3 days under shade without any

adverse effect on yield or quality of oil.

#### Storage of oil

Lemongrass oil can be stored up to 3 years without affecting the quality of oil, if kept in aluminium containers sealed air-tight using wax. The containers are to be kept in darkness.

#### Yield

The grass yield during the first year will be about 10 t ha<sup>-1</sup>, which gives about 28 kg of oil. From the second year onwards, the grass yield will be about 25 t ha<sup>-1</sup> giving about 75 kg of oil. The average recovery of oil is 0.30-0.35 per cent with 70 per cent citral for local types of lemongrass while OD-19 variety gives 0.40-0.45 per cent oil recovery and 85-90 per cent citral content.

## PALMAROSA (*Cymbopogon martinii* var. *motia*)

Palmarosa (rosha grass) is adapted to marginal areas and poor soils. The flowering tops and foliage contain sweet smelling oil emitting a rose like odour and is widely used in soaps, cosmetics and perfumery industries. The oil is also used as a raw material for producing geraniol, which is extensively used in the perfumery industry.

#### Propagation

The crop can be propagated by seeds and slips. Seedlings establish quicker and are better than slips. So seedlings are preferred as planting materials under Kerala conditions. Prepare the seedbed in well pulverized soil after 15<sup>th</sup> April. Seed rate is 4-5 kg ha<sup>-1</sup>. Seeds collected in January-February must be sown latest by August.

#### Planting

Prepare the main field for planting, form beds and plant the seedling, two on a hill, at a spacing of 30 cm x 20 cm. Apply organic manures like compost made of spent grass and wood ash @ 6 t ha<sup>-1</sup> and 2.5 t ha<sup>-1</sup> respectively at the time of formation of beds.

#### Harvesting

By about 3.5 to 4 months, the plants attain a height of 150-200 cm and they start producing inflorescence. The grass is cut one week after flowering. Generally two cuttings are made during the first year of planting. From second year onwards 3 to 5 cuttings are possible.

### Distillation

As in the case of lemongrass, extraction of palmarosa oil is done by the hydro-steam method. It takes two hours to complete one distillation. The average recovery of oil from ODP-1 (Amaravathy type) is 0.40 to 0.45 per cent. Allowing the cut grass to wilt in shade for 24 hours during monsoon season and 48

hours during the post-monsoon will increase the oil recovery.

### Plant protection

Pink globular root aphids (*Tetraneura*) occur on the roots and cause withering of the crop in patches due to desapping. Dig out and burn the affected patches and irrigate with water charged with fish oil soap or emulsion spray oil to control the aphids.

## VETIVER (*Chrysopogon zizanioides*)

Vetiver is a perennial grass, commonly known as 'khus' and mainly cultivated on hill slopes as a rainfed crop. The essential oil is extracted from the roots and known as 'khus khus oil'.

It prefers a warm climate and grows in areas up to 600 m elevation. Even though vetiver grows almost in all soils, a rich and fairly well drained sandy loam is the best. An annual rainfall of about 100 to 200 cm, temperature ranging from 25 to 40°C and moderate humidity are ideal for its growth.

Its root contains fragrant oil, which is a perfume by itself. The dry aromatic roots are made into curtains, mats, fans, etc. to emit scented cool aroma when moistened. The oil is used as a valuable fixative for blending perfumes and cosmetics.

### Varieties

Two types of vetiver namely, South Indian and North Indian (khus) are generally under cultivation. South Indian types produce higher root and oil yield, but North Indian types have superior oil quality. Among the South Indian types, the Nilambur type (ODV-3) on an average produces 5 t ha<sup>-1</sup> of root, yielding 20-30 kg oil ha<sup>-1</sup>.

### Planting

The crop is propagated through slips. June-July is the optimum period for planting. Two to three ploughing are given so that the soil is well loosened and ridges or beds of convenient length are made. Slips are planted in two rows on 1 m wide beds.

### Manuring

Usually 5 t ha<sup>-1</sup> of FYM or compost is applied at the time of bed preparation. Application of 22.5 kg each of P<sub>2</sub>O<sub>5</sub> and K<sub>2</sub>O per ha is found to be beneficial for increasing root and oil yield.

### Harvesting and distillation

The optimum period of harvest of roots to get the maximum oil yield is 18 months. Harvesting is done with the digging forks. The roots are washed gently to remove the earth and are chopped into bits of 4-5 cm length. The oil is extracted by hydro-distillation.

### Vetiver as a soil binder

Vetiver has a deep, dense and strong fibrous root system. The perennial and sterile characteristics of the crop with its hardness and unpalatability to livestock make

it an excellent soil-conserving crop. It may be planted as a contour hedge on sloppy lands or

can be used to protect the banks of major irrigation canals.

### CHETHIKODUVELI [CITRAKA] (*Plumbago rosea*)

This is an attractive erect rambling shrub with long tuberous roots and bright red flowers in long terminal spikes. The root tubers are the medicinally important parts. This is an esteemed remedy for leucoderma and other skin diseases. The synonyms of fire like 'agni', 'analah' etc. are attributed to this drug to indicate the caustic action of roots causing blisters on the skin. The drug is used only after adequate curing and purification. Roots contain plumbagin, which is responsible for the therapeutic action of the drug.

Varieties: Mridhula and Agni.

Planting materials

Propagated by single, double or three node semi-hard wood stem cuttings. Cuttings are planted in nursery beds of convenient length and 1 m width for rooting.

Land preparation

Prepare the land to a good tilth by ploughing two or three times. Make ridges of about 30 cm height and 50 cm apart for planting rooted cuttings. Two to three month old rooted cuttings can be planted on the ridges at a spacing of 15 cm in June-July.

Manuring

Cattle manure or compost @ 10 t ha<sup>-1</sup> may be applied as basal dose at the time of land preparation. The fertilizer dose for chethikoduveli is N:P<sub>2</sub>O<sub>5</sub>:K<sub>2</sub>O 50:50:50 kg ha<sup>-1</sup>. Entire P<sub>2</sub>O<sub>5</sub> has to be applied as basal dose and N and K<sub>2</sub>O in two split doses, 2 months and 4 months after planting.

After cultivation

Weeding has to be done two or three times depending on weed growth. Earthing up may be done two times along with topdressing of fertilizers.

For controlling nematodes (*Meloidogyne incognita* and *Radopholus similis*) associated with Chethikoduveli, apply *Pseudomonas fluorescens* @ 10g/plant at the time of transplanting rooted cuttings.

Harvesting

The crop can be harvested in about 12-18 months after planting. After digging out, the root tubers are cleaned by washing in water and marketed.

### NEELA AMARI [NILI] (*Indigofera tinctoria*)

Nili is a reputed drug for the promotion of hair growth. Due to antitoxic property it is also a good remedy for poisons. This plant, which is the original source of natural indigo, is an erect shrub with imparipinnate leaves. Leaves

are important in medicine and form a major ingredient of preparations like 'Nilibhringadi'.

Land preparation

Prepare the soil to fine tilth by ploughing two or three times.

### Seeds and sowing

Seeds are very small and the seed rate is 3 kg ha<sup>-1</sup>. Seeds require pretreatment for good germination, as the seed coat is hard. Seeds are mixed with sand and ground gently to break the seed coat. An alternate method for enhancing germination is dipping the seeds in boiling water for a second. After pre-treatment seeds are broadcasted. Broadcast the seeds preferably mixed with sand 2-3 times its volume to ensure uniform coverage. Seeds germinate within a week. Alternatively, 1 to 1.5 months old seedlings raised on beds or in polybags can be transplanted at a spacing of 45 cm x 30 cm.

### Seasons

The best time for sowing is September-October.

### Manuring

Apply cattle manure @ 10 t ha<sup>-1</sup> as basal dressing and incorporate into soil along with last ploughing.

### After cultivation

Weeding has to be done twice, three weeks and six weeks after sowing.

### Harvesting

Plants start flowering 2-3 months after sowing. Harvesting is done by cutting the plants at this time, at a height of about 20 cm from ground level. Irrigate plants after harvest. Subsequent harvests can be made at 1.5 - 2 months interval. Four to five cuttings can be taken in a year depending on the growth.

### Seed collection

A few plants per plot are left without cutting to set seeds. Ripe pods are to be harvested in the early morning to prevent loss of seeds by shattering during harvest.

### Pests

The psyllid *Arytaina puctipennis* infest top shoot causing curling up and drooping of leaves and shoots and wilting of plants.

## CHENGAZHINIRKIZHANGU (*Kaempferia rotunda*)

Indian crocus, also known as bhucampaka in Sanskrit, abhuyicampa in Hindi and chengazhinirkizhangu in Malayalam is a medicinal herb with aromatic rhizome. The rhizomes are used for the treatment of tumours, swellings and wounds. It helps to remove blood clots and other purulent matters in body. It is used in many ayurvedic formulations including 'Chyavanaprasam' for improving complexion and curing burning sensation, gastric complaints, mental disorders and insomnia.

### Climate and soil

The plant is distributed in the tropics and

subtropics of Asia and Africa. It grows wild in wet, humid or shaded forest ecosystems of South India. It is also cultivated as an intercrop with other commercial crops. Moist loamy soil is ideal for the crop. Laterite soil with heavy organic manure application is also well suited.

### Propagation

It is propagated through rhizomes.

### Varieties

At present, only local types are available for cultivation.

### Season

The optimum time of planting is with the receipt of pre-monsoon showers in May-June.

### Land preparation

Plough the field to good tilth. Incorporate organic manure at 10-15 t ha<sup>-1</sup>. Prepare raised seed beds of 1 m breadth and of convenient length.

### Seed rate

Use rhizome bits of size 10-15 g for planting. About 2500-3000 kg rhizomes are required for planting one hectare. Smoking the rhizomes for 2-3 weeks is good for the development of healthy sprouts. At times, rhizomes are stored in *Glycosmis pentaphylla* leaves in underground pits covered with coconut fronds.

### Planting

Pits are made at 20 cm spacing on the seed bed. Whole or split rhizomes with at least one healthy sprout is planted 5 cm deep with the sprout facing upwards and covering the pit with FYM.

### Mulching

Mulch the beds thickly with green leaves or straw @ 15 t ha<sup>-1</sup> immediately after

planting and again after two months along with weeding and topdressing. Mulching is absolutely essential for good growth.

### Fertilizer application

Fertilizer application can be skipped in fertile soils. In poor and marginal soils a moderate dose of 50:50:50 N:P<sub>2</sub>O<sub>5</sub>:K<sub>2</sub>O kg ha<sup>-1</sup> may be applied; P<sub>2</sub>O<sub>5</sub> as basal and N and K<sub>2</sub>O in two or three split doses.

### After cultivation

Remove weeds, apply manure and fertilizers and earth up two and four months after planting, followed by mulching.

### Plant protection

During rainy months, rhizome rot is noticed which can be prevented by drenching 1 per cent Bordeaux mixture.

### Harvesting and yield

The crop matures in 7-8 months. Drying up of the leaves is the indication of maturity. Dig out the rhizomes carefully, remove leaves and clean. The rhizomes with attached tubers are usually marketed afresh. Prolonged storage may cause insect and fungus attack. The average yield is 12-15 t ha<sup>-1</sup>.

## KASTHURIMANJAL (*Curcuma aromatica*)

*Curcuma aromatica* known as vanharidra in Sanskrit and kashurimanjal in Malayalam is a rhizomatous herbaceous medicinal plant. The rhizome is an odoriferous ingredient of the cosmetics used for the cure of chronic skin diseases caused by impure blood. It is used as appetizer and tonic to women after childbirth. It is also useful against high fever and worm infestation.

### Climate and soil

It is distributed in Southeast Asia. The plant grows wild in the eastern Himalayas and in moist deciduous forests of Kerala and Karnataka. It is grown as a subsistence crop in backyard, kitchen garden and interspaces of other crops in areas with good rainfall. Well-drained rich loamy soils are ideal for the crop.

**Propagation**

It is propagated vegetatively by rhizomes.

**Varieties**

At present, only local types are available for cultivation.

**Land preparation**

Clear the area, remove all the pebbles and stones and plough the field to good tilth. Incorporate FYM or organic manure @ 10-15 t ha<sup>-1</sup>. Prepare raised seedbeds of 1.2 m breadth and of convenient length.

**Seed rate**

A healthy disease free mother rhizome with at least one germinated sprout is the planting material. It is required @ 1500 kg ha<sup>-1</sup>.

**Planting**

Take small pits at 60 cm x 40 cm spacing on the seedbed and plant seed rhizomes with the germinating sprout facing upwards. Cover the rhizome with FYM and mulch the bed with leaves or straw.

**Fertilizer application**

Apply fertilizers @ 100:50:50 N:P<sub>2</sub>O<sub>5</sub>:K<sub>2</sub>O

kg ha<sup>-1</sup>; entire P<sub>2</sub>O<sub>5</sub> as basal and N and K<sub>2</sub>O in two equal splits at planting and two months after planting.

**After cultivation**

Carry out gap filling if necessary within one month. Remove weeds two months after planting followed by topdressing, earthing up and mulching.

**Plant protection**

No serious pests and diseases are encountered in the crop.

**Harvesting and yield**

The crop matures in 7 months. Drying up of leaves is the indication of maturity. Dig out the rhizomes without causing damage. Remove the dry leaves and roots. The cleaned rhizomes are either marketed or dried and stored. The average yield of fresh rhizome is 28 t ha<sup>-1</sup> which on drying gives 27 per cent recovery.

**Processing**

The rhizome is thinly sliced and steam distilled for 3-4 hours for extracting the essential oil and the yield is 90 litres per ha. Oil recovery is 0.33 per cent on fresh weight basis and 1.05 per cent on dry weight basis.

## CHITTARATHA (*Alpinia calcarata*)

*Alpinia calcarata* is also known as rasma in Sanskrit, kulainjan in Hindi and chittaratha in Malayalam. It is a perennial herb with non-tuberous pungent rootstock. It grows to a height of 1.5 m and produces around 24 suckers per clump per year. The economic part is rhizome, which is a major constituent of many

formulations of indigenous system of medicine for relieving throat inflammation, stimulating digestion, purifying blood and improving voice.

**Climate and soil**

*Alpinia* comes up well in tropical climate. It grows on a wide range of climate and soil.

Well-drained hilly areas and places up to 1400 m altitude are good for its cultivation. Fertile red loams to forests soils are suitable.

#### Propagation

It is propagated vegetatively by rhizomes.

#### Varieties

At present, only local types are available for cultivation.

#### Season

Rainfed crop is planted with the onset of monsoon in May-June. Irrigated crop can be planted at any time.

#### Land preparation

Plough the field to good tilth. Remove all pebbles and stones. Incorporate FYM or organic manure at 10-15 t ha<sup>-1</sup>. Prepare raised beds of convenient length and breadth to facilitate drainage.

#### Seed rate

Fresh healthy disease-free rhizome bits with at least one shoot is the planting material, which is required @ 1000-1500 kg ha<sup>-1</sup>.

#### Planting

Take small pits on the seedbed and plant 5 cm long rhizome bits. Cover rhizome with FYM and mulch the seedbed with leaves or straw. The optimum spacing is 40 cm x 30 cm under good fertility and 30 cm x 20 cm under poor fertility conditions.

#### Fertilizer application

Apply fertilizers @ 100:50:50 N:P<sub>2</sub>O<sub>5</sub>:K<sub>2</sub>O kg ha<sup>-1</sup> per year in two or three split doses.

Application of biofertilizer Azospirillum @ 10 kg ha<sup>-1</sup> and in situ green manuring with cowpea are beneficial for the crop.

#### After cultivation

Carry out gap filling, if required, within one month; remove weeds two months after planting followed by topdressing, earthing up and mulching. Thereafter no weeding is required as the crop smothers the weeds.

#### Plant protection

Usually pests and diseases are not serious enough to take up any control measures. Occasionally shoot borers and leaf eating caterpillars are observed. Blight disease can be controlled by spraying 1 per cent Bordeaux mixture.

#### Harvesting and yield

Though the crop can be harvested after 18 months, the optimum stage of harvest for obtaining maximum rhizome and oil yield is 36-42 months after planting. Cut and remove the shoot portion and carefully dig out the rhizomes and roots. Harvesting is very arduous due to strong and extensive root ramification. Separate the roots, clean the rhizomes and cut into 5 cm long pieces, which are dried in the sun for 3-5 days to 10 per cent moisture for marketing. The average yield of rhizomes is about 23 t ha<sup>-1</sup>, which on drying gives 25 per cent recovery.

#### Processing

The fresh rhizomes on steam distillation for 3-5 hours give 0.22 per cent essential oil. The oil recovery on dry weight basis is 0.93 per cent.



## NILAPPANA (*Curculigo orchioides*)

Black musli or Nilappana, one of the ayurvedic dasapushpas, is a small geophilous herbaceous plant with cylindrical rhizome. Rhizome is the economic part. It is a rejuvenating and aphrodisiac drug. It improves complexion and is useful in general debility, deafness, cough, asthma, piles, skin diseases, impotency, jaundice, urinary disorders etc. It is an ingredient of ayurvedic formulations like Vidaryadighrita, Vidaryati lehya, Mumma gulika, Musalyadi chuma, etc.

### Climate and soil

The plant is found through out India from near sea level to 2300 m altitude, particularly in rock crevices and laterite soil. It grows well in moist humus - rich soils especially in shady forest areas and rubber plantations. It is a shade loving plant and its growth, yield and quality are optimum under 25 percent shade. It can be grown as an under story crop or intercrop in plantations.

### Propagation

The plant is propagated through rhizome. New propagules also emerge from leaf tips in contact with soil during monsoon.

### Varieties

At present only local types are available for cultivation.

### Season

Rain fed crop is planted with the onset of monsoon in May-June. Irrigated crop can be planted any time.

### Land preparation

Plough the field to good tilth. Remove all pebbles and stones. Incorporate well

decomposed poultry manure at 2.7 t ha<sup>-1</sup> or FYM 20 t ha<sup>-1</sup>. Prepare raised beds of convenient length and breadth to facilitate drainage.

### Seed rate

Fresh healthy disease free rhizome with at least one shoot is the planting material, which is required at 750 kg ha<sup>-1</sup>.

### Planting

Fresh rhizome bits of 1.5-2 cm are planted at a spacing of 10 cm x 10 cm. 25 per cent shade is required for proper growth.

### Fertilizer application

Apply fertilizers at 10:8:5 kg N, P<sub>2</sub>O<sub>5</sub> and K<sub>2</sub>O ha<sup>-1</sup> for maximizing nutrient use efficiency and realizing highest yield of quality rhizome.

### After cultivation

Carry out gap filling, if any, within one month. Soil should be sufficiently moist to get maximum rhizome development. Two to three weedings are essential to control weeds. As the rhizome development is upward regular earthing up is required for high yield.

### Plant Protection

Seedling rot is found during rainy season and spraying 1 per cent Bordeaux mixture can control it. Rhizomes are found eaten by rodents and hence proper measures are to be taken for their control.

### Harvesting and Yield

Production of secondary rhizomes starts from fourth month. The plant grows actively upto 7 months, after which it could be

harvested for rhizome. During summer, the above ground portion dries up. Harvesting is done by digging out the rhizomes. The shoot portion and the roots are removed and the separated rhizomes are cleaned. Fresh rhizome

yield is 3-4 t ha<sup>-1</sup>. Rhizomes are sliced to 1 cm size, dried in sun and marketed or stored in gunny bags. The dried rhizome yield is 1-1.5 t ha<sup>-1</sup> (35-45 per cent dryage). Higher yield is obtained if harvested during second year.

## JEEVAKOM (*Seidenfia rheedii* Sw. Szkch)

Jeevakom is a medicinal orchid widely used in Ayurveda. It is available in the market in two forms, 'Jeevakom' and 'Edavakom'. Jeevakom belongs to the 'astavarga' group of drugs mentioned in Ayurveda. It is a short-stemmed fibrous rooted lithophytic herb with 5-7 leaves. Stem is swollen at the base forming a conical pseudo bulbil which is the part used in medicine. Jeevakom is a rejuvenating drug and an ingredient of many Ayurvedic formulations viz. Chavanaprash, Dhanwantharam kashayam, Dhanwantharam kuzhambu and Ashtavargam kashayam.

### Climate and soil

The plant is present in select pockets of India, mainly in the forests. In Kerala it occurs at altitudes ranging from 650 to 1000 m above MSL. In the forests jeevakom colonizes on decomposed organic matter on wet rocks amidst moss and grass. It is a shade loving plant and prefers 50%-75% shade for better growth, yield and quality. The crop can be grown under natural as well as artificial shade provided by shade net.

### Propagation

The plant is propagated through pseudo-bulbils. Mother bulbils cut into single node bits can also be used.

### Varieties

Only local cultivars (ecotypes) are available for cultivation.

### Season

Crop is raised as rainfed. Best time for planting is after the receipt of summer showers (May-June).

### Land preparation

Select an area receiving 50-75 percent shade (natural or artificial shade provided by shade net). Plough the field to good tilth. Incorporate dried FYM at the rate of 20t/ha<sup>-1</sup>. Prepare raised beds of convenient length and breadth to facilitate drainage.

### Seed rate

Stored pseudobulbils of previous year are used as planting material. Small side bulbils weighing 1 g or mother bulbils cut into 2g bits having single node can be used. Seed rate is 250 kg/ha<sup>-1</sup>.

### Planting

Bulbils are planted at a spacing of 10x10 cm. Bulbils are placed horizontally over the beds, they are just pressed gently into the soil. Beds are mulched heavily after planting with green or partially decomposed dry leaves.

### Manuring

Crop responds well to organic manures. Powdered FYM/leaf compost/vermicompost is applied @ 100g/m<sup>2</sup>, 60 days and 90 days after planting.

### After cultivation

Carry out gap filling if any within 30 days. Remove the weeds as and when they come

up. The crop performs well under moist condition. Cover the soil with mulch for the first 4-5 months, keep the soil moist always. Crop flowers 1-2 months after planting. Side bulbils start emerging from 4<sup>th</sup> month onwards.

#### Harvesting and yield

After six months of planting, aerial parts start yellowing. Leaves turn yellow and ultimately dry up. Bulbils are gathered from

the beds manually. Bulbils covered with the leaf sheaths are separated, roots removed. Mother and daughter bulbils are separated. Since the part used as drug and the propagule are one and the same, the mother bulbils are used as drug and the side bulbils can be used as planting material for next season. Total yield from a bed is 6.0 kg/3m<sup>2</sup>. The bulbils which are succulent in mature can be stored in earthen containers in a cool room for a period of 4-5 months without losing viability.

## ADAPATHIYAN (*Holostemma adakodien*)

*Holostemma* or *Adapathiyam* is a large, glabrous, laticiferous twining shrub, much branched, with shining stem and large conspicuous flowers. Root is the economic part. It is useful in ophthalmopathy, orchitis, cough, burning sensation, stomachalgia, constipation, fever and tridoshas. It is used in preparations of *Vidaryadi ganam*, *Dhanwandharam thaila*, *Manasa mithra vatakam*, *Balarishta* and *Anuthaila*. It is also useful in eye diseases and it imparts resistance to diseases.

It grows on a wide range of climate and soil. Well-drained hilly areas with an underlying hard pan is good for its cultivation. Fertile red loams to forest soils are suitable.

#### Propagation

The plant is propagated vegetatively by stem cuttings and by seeds. The seeds are collected from the plant in November-December before being dispersed. Seeds are cleaned, dried and stored for sowing. The stored seeds after soaking in water for 4-5 hours are sown on seedbeds. About one month old seedlings are planted in polybags, which are kept in shade

and irrigated. About 1-1.5 month old seedlings are ready for transplanting.

#### Varieties

*Jeeva* is a high yielding variety. It has purple colored stem with a yield of 4.5 t ha<sup>-1</sup> of fresh tubers.

At present, only local varieties are available for cultivation.

#### Seasons

Rainfed crop is planted with the onset of monsoon in May-June. Irrigated crop can be planted any time.

#### Land preparation

Plough the field to good tilth. Remove all pebbles and stones. Incorporate FYM or organic manure at 20 t ha<sup>-1</sup>.

#### Planting

Pits of 30 cm<sup>3</sup> size are taken at a spacing of 60 cm x 30 cm distance and filled with 10 kg dried cowdung and top soil and formed into a mound. Seedlings are transplanted on to the mounds from the polybags carefully.

**Fertilizer application**

Application of NPK @ 100:50:50 kg ha<sup>-1</sup> is beneficial.

**After cultivation**

Carry out gap filling, if any, within one month; remove weeds two months after planting followed by top dressing, earthing up and mulching. Thereafter no weeding is required as the crop smothers the weeds. Since the crop is twining in nature, pandal or stakes are to be provided to aid trailing. Regular irrigation is to be given till flowering.

**Plant protection**

Aphid infestation is seen in the crop, which can be controlled by spraying 0.05 per cent quinalphos.

**Harvesting and yield**

Flowering and fruiting occurs in November-December. Harvesting can be done one and half to two years after planting and it is better to harvest in January - February. The tubers are cut into pieces of 10 cm length and dried in sun before sale. Yield of dry tubers is about 1.5 t ha<sup>-1</sup>.

## ASOKA (*Saraca asoca*)

Asoka or Asokam is a medium sized beautiful evergreen tree growing upto 9 m in height with numerous spreading and drooping glabrous branches. The bark is useful in dyspepsia, fever, burning sensation, visceromegaly, colic, ulcers, menorrhagia, metropathy, leucorrhoea and pimples. The well-known Ayurvedic preparations are Ashokarishta and Ashokaghrita.

**Climate and soil**

Asoka grows well in areas with well-distributed rainfall and in slightly shady areas. The tree is grown throughout India except in northwestern part of the country upto an elevation of about 750 m. It grows on a wide range of soils.

**Propagation**

The plant is seed propagated. Seeds are formed usually during February-April. Seeds are collected when they are ripe and fall down.

They are sown after soaking in water for 12 hours on the prepared beds. Seeds germinate within 20 days. The seeds are then planted in polybags. 2 month old seedlings from the polybags are used for transplanting. Air layering in Asoka is found successful. Coir pith compost is the best rooting media. June-July is the ideal time for air layering.

**Varieties**

Aswani-1 is an improved variety that give high bark yield. Local varieties are also cultivated.

**Season**

The crop is planted with the onset of monsoon in May-June.

**Planting**

Square shaped pits of 60 cm depth are taken at 3 m spacing and filled with topsoil, sand and dried cow dung. 2 months old seedlings are then transplanted.

#### After cultivation

The base of the trees is to be cleared of weeds and FYM at 2 kg/tree/year may be applied twice; first in May-June and again in October-November. The dose is to be increased gradually to 10 kg from 5<sup>th</sup> year onwards. Chemical fertilizers are not usually applied. However its application during the initial years will help in better establishment of the plant. NPK at 90:45:45 g/tree/year is recommended.

#### Plant protection

No serious pests or diseases are generally noted in this crop.

#### Harvesting and yield

Asoka can be cut after 20 years for collection of bark, the medicinally useful part. It is cut at a height of 15 cm from soil level. If irrigation and fertilizers are given the stump will produce new shoots and it can be harvested again after 5 years. Alternatively, the bark can be collected without cutting down the tree. The bark is peeled off first, vertically from one side of the main trunk. The excised area is renewed with fresh bark in 1-2 years. Then, the bark on the other side can be peeled off. The process can be continued over years.

## KANJIRAM (*Strychnos nux-vomica*)

*Strychnos* or kanjiram is a large deciduous tree with a fairly straight and cylindrical bole having dark grey or yellowish grey bark and minute tubercles. *Strychnos* is highly toxic to man and animals producing stiffness of muscles and convulsions, ultimately leading to death. In small doses it can serve as efficacious cure for paralysis and other nervous disorders. Root and root bark is used in fever and dysentery.

#### Climate and soil

The plant is distributed throughout India in deciduous forests up to 1200 m. It prefers tropical and subtropical climate. It is grown in different soil types such as laterite, sandy and alluvial.

#### Propagation

It is propagated through seeds. Germination can be substantially increased by treating the seeds with hot water (50<sup>o</sup> C) for a period of six to twelve hours prior to sowing.

#### Season

Seedlings can be planted in main field with the onset of South-West monsoon in May - June.

#### Planting

Seeds are sown in poly bags. The saplings are later transplanted to the main field on to pits of about 1m x 1m taken at a spacing of 6m x 6m, filled with top soil and organic manure.

#### After cultivation

The basins of the trees are cleared of weeds and after application of manures and fertilizers covered with soil. FYM at 2 kg per tree is to be applied during early stages and the dose is gradually increased to 20kg from 5<sup>th</sup> year onwards.

#### Plant protection

No serious pests or diseases are generally noted in this crop.

### Harvesting and yield

Flowering is during March-April and fruiting during May-December. Fruits take about 8-9

months to mature. Mature pods are collected and seeds are extracted, washed, dried and stored for later use. The yield is 50-75 kg dry seed per tree per year.

## THIPPALI (*Piper longum*)

Thippali is one of the important medicinal plants used in many of the Ayurvedic drugs. Fruits as well as roots of the plant are attributed with numerous medicinal properties and are used for diseases of respiratory tract, carminative and as a general tonic for maintaining health, vigour and vitality.

It is a slender aromatic climber with perennial woody roots. It is a dioecious plant with female and male spikes seen in different plants. Male spikes are long and slender with green colour during immature stage and yellowish during mature stage. Female spikes are short and thicker and greenish in immature stage and deep black in mature stages. Dried mature female spikes are commercially marketed.

### Preparation of land

Thippali is highly adapted for warm humid tropical climate. Fertile, loamy soil having good drainage is ideal for this crop. Sandy soil with high organic content is also well suited. It is a shade loving plant and can be cultivated in middle aged coconut gardens and also in similarly shaded plantations.

### Seed materials

3-5 noded rooted cuttings are used for planting in the field.

### Varieties

Variety 'Viswam' is recommended for higher spike yield both in irrigated open and

shaded conditions. It recorded 800 to 850 kg dry spikes per hectare in open condition and 350 to 400 kg in coconut gardens during second year of planting.

### Season, method of planting and manuring

In a well ploughed land, beds of 1m width and of convenient length may be taken and pits are taken at a spacing of 60 cm x 30 cm. FYM @ 20 t ha<sup>-1</sup> is needed for one hectare. Between the beds channel of about 30 cm depth have to be provided for easy drainage of water. Two rooted cuttings per pit have to be planted during the month of May-June after the receipt of 4-5 pre-monsoon showers.

### Irrigation

If it is a sole crop irrigation may be provided once in a week and as an intercrop in irrigated gardens, irrigation for the main crop will be sufficient for this crop also. If irrigation is not possible during summer months mulching using dried leaves is recommended.

### Weeding

During the first year the field should be free from weeds and second year onwards the whole field will be covered by the growth of vines.

### Plant protection

For controlling nematodes (*Meloidogyne incognita* and *Radopholus similis*) apply

*Pseudomonas fluorescens* @ 10 g plant<sup>-1</sup> is recommended.

#### Harvesting and curing

Mature female spikes can be harvested seven months after planting. Black matured

female spikes can be harvested at weekly intervals. The spikes are to be dried under shaded conditions for two weeks. The dry spike yield will be 1/5<sup>th</sup> of the fresh weight of the spike.

## NEEM (*Azadirachta indica*)

Neem is known as Aryavepu in Malayalam, Neem in Hindi and Nimba in Sanskrit. All parts of the plant viz. stem, bark, leaves and root bark are useful. The bark gives bitter tonic and is an astringent and is useful for fevers and skin diseases. It is also having insecticidal property.

#### Climate and soil

The tree is well distributed throughout the tropics and subtropics. It is also grown in homesteads of Kerala, Tamil Nadu, Karnataka etc. Well drained loamy soils are suitable for its cultivation.

#### Propagation

It is propagated through seeds. Seeds are to be extracted from fresh fruits after pulping and sown without delay.

#### Cultivation

Plough the field and pits of size 60 cm x 60 cm x 45 cm are taken at a distance of 4 m. The pit is covered with FYM @1 kg/pit and top soil. The seedlings are planted in the centre of pit. Irrigate the crop regularly. Mulching the crop in the early stages is found to be good.

## PATHIMUGHAM (*Caesalpinia sappan*)

The Heart wood is the economic part used for medicinal purpose. Natural dye extracted from the heart wood of the tree is used for coloring textiles, liquors etc. on a commercial scale.

#### Cultivation

It can be grown in any type of soil but cannot tolerate waterlogging. Seeds are used for propagation. The seeds are dipped in water for 12 hours before sowing in the nursery. Six months old seedlings can be transplanted to the field by the onset of South West monsoon.

Plough the field and pits of size 60 cm x 60 cm x 45 cm are taken at a distance of 2.5-3 m. It is best grown as a fence crop.

#### Management

Prune the side branches from 1<sup>st</sup> year onwards and allow one or two branches to grow.

#### Harvesting

The harvesting can be done from 7-8 years after planting. About 20kg heart wood is obtained on an average from a single plant. The stump regenerates and a ratoon crop is also obtained.

## CHITTADALOTAKAM (*Adathoda beddomei*)

Chittadalotakam is known as 'vasa' in Sanskrit. It is used in many ayurvedic preparations against cough, rheumatic complaints, bronchitis etc. The whole plant, leaves and roots are the economic parts.

### Varieties

Ajagandhi and Vasika.

### Propagation

It is propagated by soft wood cuttings. Well-drained loamy soils are best suited for cultivation. It can tolerate shade and can be grown as inter crop in coconut and rubber gardens. It can be planted on mounds or ridges in levelled field. In sloppy areas pits can be taken for planting. The soft wood cuttings are

planted in poly bags and when they attain 4-5 leaves in 2 months, they are transplanted in the main field. FYM @ 10 t ha<sup>-1</sup> is applied at the time of planting. Cuttings are planted at a spacing of 60 cm x 30 cm. Irrigate the crop at an interval of 4 days. The crop can be harvested 2 years after planting.

### Harvesting

The leaves can be collected one year after planting. The roots are harvested two years after planting and it is better to harvest in December-January. After the harvest the roots are washed in water, dried and can be stored in air tight steel containers upto five months without quality deterioration.

## KOOVALAM (*Aegle marmelos*)

In Sanskrit it is known as vilwam and it is one of the ingredients of "Dasamoola". The drug comprises of ripe or half ripe fruits of the tree. The fruit is very useful in chronic diarrhoea and dysentery. The unripe or half ripe fruits improve appetite and digestion. The leaves and roots are effective against stomach complaints and diabetes. There are 2 types of Koovalam, North Indian type and South Indian type, of which North Indian type is suitable for cultivation. The fruits of these are edible.

### Propagation

The fruits mature by December-January. The seeds are extracted from the fruit and dried

under sun. The seeds are dipped in water for 6 hours and are sown in furrows. Mulch the furrows with dried leaves. The seeds will germinate within 15 - 20 days after planting and they are transplanted to poly bags at 5 - 6 leaf stage. 2 months old seedlings are used for field planting.

### Land preparation and planting

Plough the field, and pits of size 60 cm x 60 cm x 45 cm are taken at a distance of 4 m. The pit is covered with FYM @ 1 kg/pit and top soil. The seedlings are planted at the centre of pit. Irrigate the crop regularly.



## THULASI (*Ocimum tenuiflorum*)

Indians are having age-old practice of growing thulasi in their homes. The whole plant of thulasi is used for medicinal purpose. It is used for extraction of oil and as an antibiotic and astringent. It is effective against cough complaints.

### Cultivation

It is grown in well-drained soil and cannot tolerate waterlogging. The propagation is by seeds. The seeds are sown in nursery beds two months before planting. Apply FYM/compost @ 2 kg/bed and mix well with soil. The seeds are sown at a depth of 1-2 cm and cover with soil or FYM. Irrigate using sprinkle hose. Since the seeds are very small, mix with sand @ 4 times the quantity of seeds for sowing and the seed rate is 500 g ha<sup>-1</sup>. The seeds

germinate by 8 – 12 days and are ready for transplanting by 6 weeks after planting.

The field is ploughed to a fine tilth and ridges are taken at a distance 40 cm. Apply FYM or compost @ 10t ha<sup>-1</sup>. The 2 months old seedlings are transplanted at a spacing of 30 cm. Irrigate the crop in alternate days up to 2 weeks after planting. After 2 weeks, irrigate the crop @ 2 irrigations/week. Remove the weeds 2 or 3 times. Earth up the field at 2 months after planting.

Harvesting can be done 90–95 days after planting. The above ground portion is cut at a height of 15-20 cm from the ground level. Harvest the crop in a sunny day to increase the oil content of the plant. Keep the harvested produce in the field for 4-5 hrs to reduce the water content and weight of the produce.

## KARINOCCHI (*Vitex negundo*)

In Sanskrit it is known as Nurgundi. The flush as well as the stem portion are used for medicinal purpose. It is effective against rheumatic and cough complaints and used in several ayurvedic preparations.

### Propagation and planting

Propagated by rooted cuttings. Plough the field and pits of size 45 cm<sup>3</sup> are taken at a distance of 3 m. From second year onwards up to 10<sup>th</sup> year after planting the leaves can be harvested at regular intervals.

## KATTARVAZHA (*Aloe vera*)

Kattarvazha is known as kumari in Sanskrit. The leaves are used for medicinal purpose. It is grown well in open areas receiving good amount of sunlight. The suckers are used for propagation. The field is ploughed to a fine tilth and the suckers are planted at a spacing of 45 cm x 30 cm. Apply FYM or

compost @ 5t ha<sup>-1</sup> at the time of land preparation. The mature leaves can be harvested from the bottom of the plants. After each harvest apply FYM along with earthing up. The harvesting of leaves can be done up to 3 years at 2 months interval. The side suckers can be used as planting material.

## ARROW ROOT (*Maranta arundinacea*)

Rhizomes are used for the production of starch. Starch grains are small and easily digestible. Hence it can be used as food for infants. It has also medicinal value against dysentery.

### Propagation

It is propagated vegetatively by rhizomes. Healthy disease free rhizomes with at least one germinated sprout is the planting material. Small pits at 50 cm x 30 cm spacing on the

seed bed are taken and plant seed rhizome with germinated sprout facing upwards. Cover the rhizome with FYM and mulch the bed with leaves or straw. Weeding is done 2 or 3 times along with earthing up and mulching.

The crop matures in 7 months. Drying of leaves is the indication of maturity. Dig out rhizomes without damage. Remove the dry leaves and roots. The cleaned rhizomes are either marketed or dried and stored.

## DANTAPPALA (*Wrightia tinctoria*)

Dantappala, known as Vettuppala in Tamil and Ivory wood in English has much importance in both Ayurveda and Siddha medicines. It is very effective medicine for the dreadful skin disease psoriasis.

### Climate and Soil

The tree is well distributed in Western Ghats, Deccan, parts of Gujarat and Konkan areas. Well drained forest soil and laterite loamy soils are suitable.

### Propagation

It is propagated through seeds. The seeds can be collected from the trees during August-September. The seedlings can be raised in polybags containing potting mixture and will be ready to transplant after three months of growing. The seedlings are transplanted at a spacing of 5m x 5m in pits of

size of 60 cm x 60 cm x 45cm covered with farm yard manure @ 2kg/pit and top soil. Irrigate the plants regularly till it establishes. Mulching the plant in early stages is found to be good.

### Dantappala oil

Dantappala oil prepared from the leaves of this plant is used for curing psoriasis. Mature leaves plucked from the trees will be crushed immediately and exposed to sunlight in fresh coconut oil in the ratio of 1kg dantappala leaves and 1kg coconut oil for psoriasis and 500g dantappala leaves and 1kg coconut oil for dandruff and pre-mature greying. The exposure of leaves to sunlight may be repeated for three days consecutively till the coconut oil will turn into deep violet colour. It is filtered and stored.

## BRAHMI (*Bacopa monnieri*)

Brahmi is used as a memory booster and nerve tonic. It is a safe cardiac stimulant. Brahmi is used in ayurvedic preparations like Brahmigritham, Saraswatarishtam, Brahma thailam etc.

It grows in moist and marshy areas. It comes up well on borders of water channels, wells and irrigated fields. It is propagated vegetatively through stem cuttings.

The field is prepared by ploughing and

shallow beds of about 5 cm deep are prepared to maintain the moist condition during the crop growth. Two-three noded healthy disease free vine cuttings are planted at a spacing of 20 cm x 10 cm in the field. Apply farmyard manure @ 10 t ha<sup>-1</sup> at the time of field preparation. During crop growth period wet condition should be maintained by providing irrigation. Weeding is done two times along with slight raking of soil during the first weeding. The optimum stage for harvesting is five months after planting. Harvesting is done by uprooting the whole plant and by cutting the plants. When harvested by cutting regrowth

takes place from nodes above soil. Apply farmyard manure after each harvest. Subsequent harvests can be done at three months interval. Three cuttings can be taken in a year depending on growth and can be continued up to two years after which it is replanted. The marketing is done in fresh form as well as after drying depending on the fluctuation of price in the market. The fresh form is marketed immediately after harvest. The harvested produce is washed and dried under shade. The dried material can be stored up to 6 months without damage in air tight containers. The weight of herbage is reduced to 1/4<sup>th</sup> of the fresh weight after drying.

### KURUMTHOTTI (*Sida alnifolia*)

*Sida* prefers open condition for maximum yield and quality. The best time for planting *Sida* is before the onset of monsoon.

Optimum spacing : 50 x 25 cm.

Optimum stage of harvest is 8 months after planting.

### MEDICINAL PLANTS AS INTERCROPS IN HOMESTEADS

Neelamari is recommended as intercrop in homesteads of coconut based intercropping situation with 20 to 40 per cent shade intensity.

Thulasi, Panikoorka and Kiriya are recommended as intercrop in homesteads of coconut and coconut + arecanut based

intercropping situation with 20 to 60 per cent shade intensity.

Kasthurimanjal is recommended for cultivation under intensive homestead system with Coconut + Arecanut + Pepper based intercropping situation.

## FODDER CROPS

### GUINEA GRASS (*Panicum maximum*)

Guinea grass is a popular fodder grass of the tropics suited to the agro-climatic conditions of Kerala. It can be profitably grown as a component of agro-forestry systems and comes up well under coconut and other trees. As an excellent fodder it is much valued for its high productivity, palatability and good persistence.

It is a perennial bunch grass, 0.5 to 4.5 m high. The stem is stout to slender, erect or ascending, glabrous or hairy. Leaves are 10 to 100 cm long and 3.5 cm wide. Panicle loose and much branched, the lower most branches being in a distinct whorl. The small seeds are enclosed in smooth glumes. The seeds shatter. The root system is deep, dense and fibrous.

The important varieties are Makueni, Riversdale, Hamil, PGG-4, FR-600, Haritha, Marathakom and Harithasree. Makueni is a drought resistant cultivar suited to rainfed situations in the state.

Guinea grass thrives well in warm moist climate. It can grow from sea level to 1800 m altitude. It is frost sensitive. It thrives between a temperature range of 15 to 38°C. The grass tolerates shade and grows under trees and bushes and is best suitable as an intercrop in coconut gardens. The grass is adapted to a wide range of soils. It usually grows on well-drained light textured soil, preferably sandy loams or loams, but is better suited to medium to highly fertile loams. It cannot tolerate heavy clays or prolonged waterlogging.

Under Kerala conditions, the best season

of planting is with the onset of south west monsoon during May-June. As an irrigated crop planting can be done at any time of the year.

Seeds and slips can be used as planting material. Since seed germination is poor vegetative propagation is preferred. To obtain slips for planting, old clumps are uprooted and slips with roots are separated. For planting one hectare, 1.25 lakhs of slips are required. If seeds are used (3 kg ha<sup>-1</sup>), it should be sown in nursery and the seedlings transplanted in the main field.

The grass requires thorough cultivation to prepare a weed-free seedbed for establishment. For this, two or three ploughings and one levelling are sufficient. In the prepared field, trenches of 10 cm width and 20 cm depth are made. In these trenches, FYM should be applied along with phosphorus and potassium fertilizers. Mix with soil and cover the trenches and form ridges of 15 cm height for planting slips. In acid soils, application of lime @ 500 kg ha<sup>-1</sup> in alternate years is desirable.

Slips are planted on ridges @ three slips per hill. The spacing of 40 cm x 20 cm is followed when grown as an intercrop. For a pure crop, a wider spacing of 60 cm x 30 cm is required.

A basal dose of 10 tonnes of FYM, 50 kg P<sub>2</sub>O<sub>5</sub> and 50 kg K<sub>2</sub>O ha<sup>-1</sup> (applied in trenches) is recommended. For top dressing, use 200 kg N ha<sup>-1</sup> in two split doses, the first dose immediately after first cutting and the second dose during the northeast monsoon period. If irrigation facilities are available, top dressing can

be given in more splits. The fertilizer may be applied on either side of the plants, along the row and earthed up.

At planting two irrigations are required within seven to ten days for quick establishment. The crop should be subsequently irrigated depending upon the rainfall and soil type. Usually irrigation once in 7-10 days is required. Irrigation with cowshed washing or sewage water within 3-4 days after cutting gives better growth.

The delicate seedlings or newly emerged shoots from slips or cuttings require protection from weeds in the first two months. Two intercultivations should be given during this period. Later, intercultivation may be necessary after three

or four cuttings.

The crop is ready for harvest when it reaches 1.5 m height. Cutting at 15 to 20 cm above the ground level is advised. The first cut is usually ready in 9-10 weeks after planting and subsequent cuts are taken at 45 to 60 days intervals. About six to seven harvests can be made in a year.

Approximately 80-100 t ha<sup>-1</sup> of green fodder is obtained per year.

Guinea grass can be grown mixed with leguminous fodder crops such as cowpea, stylo and siratro.

The grass is nutritious, palatable and free from oxalates. It makes good hay and silage. The crude protein and the crude fibre content of this grass vary from 8 to 14 per cent and 28 to 36 per cent respectively.

## GAMBA GRASS (*Andropogon gayanus*)

Gamba grass is also known as 'Sadabahar'. It is a tufted perennial grass and the stems are usually 1-2 m high. The inflorescence is a large spathe or panicle.

The grass tolerates drought and suits areas where dry season lasts for five months or so. In areas with less severe drought it can remain green throughout the year. It tolerates deep seasonal flooding. The grass avoids heavy soil, is resistant to grass fires and develops new leaves and shoots a few days

after burning. The crop comes up well in partial shade and is a good intercrop in coconut gardens. The crop can be propagated through rooted slips or seeds lightly drilled.

Cultural operations and management are similar to that of guinea grass.

In general about 50 to 80 t ha<sup>-1</sup> of green matter is produced in the first year. From the second year onwards there is a slight increase in green fodder yield. The grass has excellent palatability with 5.5 per cent crude protein and 32.6 per cent crude fibre.

## SETARIA GRASS (*Setaria anceps*)

*Setaria anceps* is also called as Golden Timothy. The grass comes up well in the medium rainfall areas in the tropics and subtropics.

Important varieties are Nandi, Narok and Kazungula.

The grass is a tufted perennial with erect stems and grows 1-2 m in height. Leaves are

about 40 cm long, 8-20 cm wide and green to dark green in colour. Panicle is dense, cylindrical, about 10 to 30 cm long and orange to purplish in colour. Spikelets are two in number; the lower one is the male or sterile and the upper one is bisexual.

Usually the grass grows under an annual rainfall of over 750 mm. It grows vigorously under high annual rainfall ranging from 1000 to 1500 mm. It can also survive long, hot and dry seasons. The grass grows well at 20 to 25°C. It is more cold tolerant than most of other tropical and subtropical grasses. It can come up in a variety of soil types.

This perennial grass requires thorough land preparation; two or three ploughings/diggings followed by one levelling. The land should be free from weeds.

Propagation is through rooted slips as well as through seeds. Seedlings can be raised in nursery and transplanted during rainy season under rainfed conditions. If irrigation facilities are available, planting can be done at any time between February and November.

As a pure crop it is planted at 50 cm x 30 cm spacing. The row-to-row distance may be increased to 60-70 cm when the soil is poor and irrigation facility is absent. For intercropping with legumes, 100 cm x 30 cm spacing is followed. If seeds are used, seed rate varies from 3.5 to 4.0 kg ha<sup>-1</sup>. In case of rooted slips, the number of slips required varies from 33500 to 67000 per ha. Organic manure, either FYM or compost @ 10 t ha<sup>-1</sup> may be applied at the time of land

preparation. The crop responds well to application of fertilizers especially N. The fertilizer requirement depends on the initial nutrient status of the soil.

The grass flourishes in moist, but not wet soils. Setaria plots should be well drained during rainy season. At establishment, the crop requires two successive light irrigations in 7-10 days interval. Subsequent irrigation should be given as and when necessary.

One or two weeding or intercultivation is given in the first 2 to 3 months. To control weeds and to encourage fresh sprouts, one or two intercultivation has to be carried out every year.

The crop is ready for harvest by 9-10 weeks. Subsequent cuts can be taken after every 40 to 60 days depending on the crop growth. At harvest, a stubble height of about 8 to 10 cm is left for good regeneration.

Generally, about 25-40 t ha<sup>-1</sup> of green fodder can be harvested per year under rainfed situation. Irrigated crop yields about 75-150 t ha<sup>-1</sup> per year.

The grass can be used as green cut fodder, silage and hay. The grass gives satisfactory silage with molasses. The crude protein and crude fibre content of the grass range from 4.8 to 18.4 per cent and 24 to 34 per cent respectively.

Seed yields are low due to prolonged emergence of panicles, prolonged flowering of the same panicle, early shedding of spikelets, bird damage etc. Denser stands give more uniform panicle emergence than widely spaced plants. Fertilizer application is compulsory in seed production.

## HYBRID NAPIER (*Pennisetum typhoides* x *P. purpureum*)

Napier grass is also called as elephant grass due to its tallness and vigorous vegetative growth. The plants tiller freely and a single clump may produce 50 tillers under favourable climatic and soil conditions. Unfortunately, the grass is coarse-textured, the leaf blade and sheaths hairy, leaf margins sharply toothed and stems less juicy and fibrous. In 1953, a cross was made in India with bajra which is more succulent, leafy, fine textured, palatable, fast growing and drought resistant than Napier to combine these qualities with its high yielding potential.

Compared to Napier grass, Hybrid Napier produces more tillers and numerous leaves. It grows faster and produces more herbage but the stems are hard and the plants less persistent. Pusa Giant Napier has larger leaves, softer and less persistent hairs on leaf blades and sheaths and less sharp leaf edges. The stems are also less fibrous than Napier. The tillers are more numerous and grow faster.

The grass grows throughout the year in the tropics. The optimum temperature is about 31°C. Light showers alternated with bright sunshine are very congenial to the crop. Total water requirement of the grass is about 800-1000 mm. Hybrid *Pennisetum* can grow on a variety of soils. Light loams and sandy soils are preferred to heavy soils. The grass does not thrive well on waterlogged and flood prone lands. Phenomenal yields are obtained from very deep fertile soil rich in organic matter. It tolerates pH ranging from 5 to 8.

Hybrid Napier requires a deep, thorough weed free and compact seedbed. Three or four ploughings followed by disc harrowing is ideal.

The popular hybrids are Pusa Giant Napier;

Gajraj, NB-5, NB-6, NB-21, NB-35, Suguna and Supriya.

Planting is done with the onset of southwest monsoon. Being a sterile hybrid, the grass is planted by rooted slips or by stem cuttings. Cuttings of moderately mature stems (3 months old) and preferably from the lower two thirds of the stem length sprout better than the older stems. The cuttings with three nodes are stuck into the soil with the basal end down, either vertically or at an angle to such a depth that two nodes remain within the soil and one above the soil surface. The under ground nodes develop roots and shoots while the upper ones develop shoots only.

A spacing of 60 cm x 60 cm is recommended for pure crop of Hybrid Napier. In intercropping system, spacing is adjusted to accommodate the companion crops. The planting rate depends upon the spacing and the weight of the cuttings or rooted slips used. It is modified in crop mixtures or intercropping with other forage crops.

Farm yard manure @ 25 t ha<sup>-1</sup> and P<sub>2</sub>O<sub>5</sub> and K<sub>2</sub>O @ 50 kg ha<sup>-1</sup> each may be applied at the time of land preparation. Apply N @ 200 kg ha<sup>-1</sup> in two or three split doses followed by gentle raking, if possible.

The field should be provided with good drainage during the rainy season, as the crop cannot withstand water stagnation. Frequency of irrigation depends upon the rainfall and weather conditions.

Early intercultivation once or twice is necessary before the plants establish and grow vigorously. Subsequently, intercultivation should be given as and when necessary.

The first cut is taken 9-10 weeks after planting. Subsequent cuts are taken after four to six weeks or when the plant attains a height of 1.5 m. Annually at least six to eight cuts are possible. In order to encourage quicker regeneration from the basal buds, stubbles of 10-15 cm is left out at harvest.

Green fodder yield ranges 200-250 t ha<sup>-1</sup> per year from 6-8 cuttings.

The grass can be intercropped with legumes such as cowpea, *Calapogonium*, *Centrosema* and *Glycine*. Intercropping with legumes improves the quality of fodder.

Hybrid Napier is superior in quality than Napier grass and contains about 10.2 per cent crude protein and 30.5 per cent crude fibre. The leaves are larger and greener; the sheaths are softer and the margins less serrated and

hence the herbage is more palatable. It is juicier and succulent at all stages of growth. It is less fibrous and more acceptable. The oxalate content of some of the varieties may be high. It can be mitigated if harvested at longer intervals (45 to 60 days).

The grass is ideal for green fodder, silage and hay.

The fodder may be cut into pieces using a chaff cutter and ensiled. Legume fodders may be mixed with the grass in the ratio of 1:2 to produce balanced silage. The fodder can also be converted into hay during the dry summer periods. The chaffed material is exposed in the sun by spreading uniformly for a day. Further drying is done under the shade to preserve colour. The quality of the silage or hay remains more or less the same as green fodder.

## PARA GRASS (*Brachiaria mutica*)

This grass is also known as buffalo grass, water grass, Angola grass and Mauritius grass. The crop responds well to sewage irrigation and is usually grown near large sewage disposal farms.

It is a coarse, trailing perennial that spreads by surface runners which root profusely at the nodes with flowering stems 1 to 2 m high. The culms are erect, leafy, hollow, succulent and glabrous with hairy nodes. The leaf blades are dark green in colour; 25 to 30 cm long and 1 to 2 cm broad. Inflorescence is a panicle. Flowering is hastened in shorter photoperiods.

The grass prefers hot and humid climate of the tropics and subtropics with high annual rainfall ranging between 1000 and 1500 mm.

It can withstand short term flooding and waterlogging but cannot be grown in dryland in arid and semi-arid regions. It is sensitive to cold. It makes no growth during winter months.

The grass grows in moist, but not in highly wet soils. It thrives best on highly fertile clay loam to clayey textured soils with high moisture retention capacity. It can be grown even on sandy soils with good irrigation facility. It tolerates slightly acid to alkaline soils. It is highly tolerant to saline or sodic soil conditions. It grows well on field bunds, banks of streams and canals, lowlands and soils too wet for normal farm crops.

Prepare the land thoroughly by three or four ploughings and remove weeds.

Planting can be done at any time other than



winter months. The rainfed crop is planted with the first monsoon showers.

Stem cuttings or pieces of creeping shoots 15 to 30 cm long with about three joints are generally planted in a slanting position. In order to save time and labour, the planting materials are scattered in the field and covered by ploughing crosswise during monsoon season. Seeds can also be used for direct sowing or sowing in nursery for transplantation. However, poor seed setting usually discourages seed propagation.

Slips can be planted 50 to 60 cm apart both ways between plants and rows. The growing runners quickly root at the joints, tiller profusely and cover the field.

The requirement of slips for planting ranges from 27000 to 40000 per ha. The seed rate recommended is 2.5 to 3.5 kg ha<sup>-1</sup>.

The crop is highly responsive to irrigation with cattle-shed washing or sewage water. Apply 40 tonnes of FYM or compost along with 30 kg P<sub>2</sub>O<sub>5</sub> and 30 kg K<sub>2</sub>O per ha as basal dose. Topdressing N 40 kg ha<sup>-1</sup> after each harvest is found to enhance the forage production.

Two or three light irrigations are to be provided for the initial establishment of the crop.

Later on, irrigation once in 10 to 15 days in summer is advantageous.

The land should be kept weed free for the first two months. Since it is a sturdy and aggressive grass, once it gets established, the weeds that appear later are suppressed.

The competitive vigour of para grass interferes with the co-existence of legumes. First harvest is done about three months after planting when the grass attains a height of about 60 to 75 cm. Subsequent cuts are taken at 30 to 40 days interval. Annual yield of about 70 t ha<sup>-1</sup> is obtained.

As para grass herbage dries slowly when cut, it is not suitable for hay-making. However, it can be used for ensiling. It is a nutritious high yielding and palatable forage grass. The grass appears to be free of any toxic effect. Nutritive value is comparatively less. The crude protein ranges from 2.8 to 16.1 per cent and crude fibre from 28 to 34 per cent.

Seed yields are generally low. It is observed that shorter or longer day lengths hasten flowering. The correct stage of harvest is soon after the end of anthesis. Germination is affected if the seed is harvested late. There is no post-harvest dormancy for seed.

## CONGOSIGNAL GRASS (*Brachiaria ruziziensis*)

Congosignal can be grown as a sole crop in open areas and as an intercrop in coconut gardens. It is a creeping perennial with dense foliage and therefore can be used for soil conservation purpose as strip crop. It grows to a height of about 50 to 100 cm and produces 30 to 40 tillers on an average.

It prefers a warm moist tropical climate. It can be grown in almost all types of soils but

cannot tolerate waterlogging. It also tolerates shade. So it is recommended as an intercrop in coconut garden. It can be grown either as a pure crop or mixed with other grasses and legumes.

The crop is generally planted in May-June and September-October with the onset of rains. Prepare the land by ploughing one or two times, removing weeds and levelling. Both

seeds and slips can be used. A seed rate of 2-5 kg ha<sup>-1</sup> is recommended. For sowing, a fine seedbed is required and seeds are broadcast at 1-2 cm depth. To protect the seeds from ants, dusting carbaryl 5 per cent DP at the time of sowing is effective. When slips are used, they are planted at a spacing of 40 cm x 20 cm.

Basal application of 5 t ha<sup>-1</sup> of FYM along with 50 kg ha<sup>-1</sup> each of P<sub>2</sub>O<sub>5</sub> and K<sub>2</sub>O is recommended. Nitrogen @ 100-150 kg ha<sup>-1</sup> may be applied in two or three splits.

Intercultivation during early growth stages is advisable to check weed growth.

It can also be grown as a crop mixture with leguminous fodder crops.

The first harvest can be done 50 days after planting and subsequently at 30-40 days interval. Rainfed crop yields about 35-45 t ha<sup>-1</sup> of green fodder whereas the yield will be increased to about 50-100 t ha<sup>-1</sup> under irrigated conditions.

## FODDER TREES

### SUBABUL (*Leucaena leucocephala*)

Subabul is also known as leucaena or ipil-ipil. It had its origin from Mexico and is now widely spread throughout the tropical and subtropical countries of the world.

It is a perennial hardy evergreen shrub. It has deep and strong taproot and even the seedlings are deep rooted. The leaves are bipinnate, 15 to 20 cm long with 10 to 15 pairs of pinnate leaves. Inflorescence is globular and the flowers are white. There are four types of subabul as described below.

Hawaiian type: The plants are short bushy and remarkably drought tolerant. It is suited to hilly terrains in drought prone areas. It is a prolific seed producer and is good for fodder purpose. K-341 is a Hawaiian variety.

Salvador type: Tall, tree like and fast growing having maximum annual biomass production. Possesses large leaves, pods and seeds than Hawaiian types. Responds to high fertilization. Variety K-8 is useful for fodder.

Peru: Tall and extensively branching type and is ideal for fodder purpose.

Cunningham: It is a cross between Salvador and Peru types.

Subabul is best suited for warm regions and grows well between 22 and 30°C in regions of 500 to 2000 mm annual rainfall. Because of its strong and deep root system, the tree is highly drought resistant. It is restricted to elevations below 500 m but it withstands variations in rainfall, sunlight, windstorm, slight frost and drought. It cannot withstand waterlogging. It requires a deep well drained neutral soil and can tolerate saline and acid soil. It can also be grown in steep slopes, hilly terrains, gravelly areas and sandy loams.

Planting of seedlings can be done with the onset of rains in May-June or September-October.

Seed viability is high, but possess dormancy because of hard seed coat. To hasten germination seeds are to be dipped in concentrated sulphuric acid for four minutes and then washed or put in hot water at 80°C for four minutes. Sundry the seeds afterwards for about one hour before sowing.

A seed rate of 3-4 kg ha<sup>-1</sup> is recommended. Sowing is preferably done during February-March in a nursery or polythene bags or in situ at 2-3 cm depth. Give irrigation if there is no rain. Seedlings (1.5 to 3 months old with 6-8 leaves) are planted in the main field. A spacing of 1 m x 0.1 m is recommended for a pure crop of fodder, 1.5 m x 0.2 m for planting in boundaries and borders of coconut gardens and 2 m x 0.2 m when raised along boundaries.

It can grow under a wide range of conditions as a range plant, roadside plant, in pastures etc. The land should, however, be cleared of bushes, ploughed and levelled before sowing.

A basal application of N:P<sub>2</sub>O<sub>5</sub>:K<sub>2</sub>O @ 20:50:30 kg ha<sup>-1</sup> is recommended.

Since the early growth of the crop is slow, the tender plants are to be protected from aggressive weeds. Two or three inter-row cultivation is essential to check weeds in early life. Once established, even vigorous grasses seldom smother the plants.

*Leucaena* combines well with many

grasses like guinea, pangola, dinanath, Hybrid Napier etc.

Subabul is a highly nutritious leguminous tree fodder with 27-34 per cent protein. The fodder is rich in carotene and vitamin A. Pro vitamin A content is the highest among all plant species. The foliage contains an uncommon amino acid, mimosine, which is toxic to non-ruminants at levels of about 10 per cent of the diet.

Subabul starts flowering at 125-150 days after planting. First cutting is done after 5-6 months at a height of 70-80 cm from the ground level at a time when the plants reach a height of 1.5-1.75 m. Subsequent harvests can be made at 50-60 days interval depending on the re-growth. When planted in boundaries, the main shoot is not cut; only side branches are cut for fodder, leaving the top three branches.

In gravelly soil and in low rainfall areas, a yield of 25-30 tonnes per ha per year may be obtained. The irrigated crop may produce 100 t ha<sup>-1</sup> of green fodder per year in seven to eight cuttings.

## HEDGE LUCERNE (*Desmanthus virgatus*)

It is a small shrub, 2 to 3 m tall and roughly resembles *leucaena*. It is a native of tropics and subtropics of the new world, palatable, aggressive, persistent and tolerant to heavy grazing. It has 22 per cent protein in leaves and 10-15 per cent in stems. It is

highly productive, yielding about 40 to 70 tonnes of green fodder per ha per year. No poisonous principle is observed in the foliage. Because of its pithy stem, the harvesting is easier. It is an ideal plant for wasteland development.

## AGATHI (*Sesbania grandiflora*)

The outstanding feature is its extremely fast growth rate, especially during the first three to four years. Average wood yield of 20 to 25 m<sup>3</sup>

per ha is commonly achieved. It is easy to propagate by direct seeding. Prolific nodulation and extremely large nodules are

its characteristic features. Cattle relish both its leaves and pods. After cutting, shoots re-sprout with vigour. It is not toxic to cattle. It can be planted very densely @ 3000 stems per ha. It has been viewed as a source of pulp for paper industry. Leaves contain

36 per cent crude protein. Agricultural crops continue to grow well when intercropped with *S. grandiflora* whose open crown allows sunlight to pass. It is adapted to the moist tropics with annual rainfall in excess of 1000 mm.

### SHEVRI (*Sesbania aegyptica*)

It is a promising perennial fodder shrub for both dry and wet areas. The sub-marginal lands that are not suited for agricultural purposes can be used for growing this fodder plant. The leaves and young twigs form

nutritious forage to animals. The plants can be sown at a spacing of 100 cm x 50 cm. When cut at 50 cm height at 60 days interval, green fodder yield of 12 tonnes per ha per year can be obtained.

## FODDER LEGUMES

### FODDER COWPEA (*Vigna unguiculata*)

Cowpea is the most important leguminous fodder crop suitable for both summer and rainy seasons, mainly due to its quick growing habit and high yielding ability.

Cowpea is indigenous to Africa and India. It has been cultivated from very early times for human consumption. Fodder cowpea can be profitably grown as a summer crop in rice fallow of sandy loam soils where water is not available to raise a subsequent crop. It can be considered as a complementary crop in the rotation sequence of rice-rice-cowpea because of the leguminous organic residues available for fertility enrichment.

Cowpea is grown as a seasonal crop, which is bushy, trailing or climbing. Stems are 1 to 3 m long, glabrous or slightly hairy. Leaves are trifoliolate, inflorescence auxiliary having a few to several flowers. Pods are linear and cylindrical.

A number of varieties like Karnataka local, RS-9, UPC-1956, UPC-5287 and UPC-

9805 are recommended for cultivation for fodder purpose.

Cowpea is best suited for moderately humid areas of the tropics and subtropics. It usually grows in latitude between 30°N and S and up to 1500 m elevation. The plant cannot withstand frost, excessive and prolonged waterlogging, while some varieties are resistant to heavy rains. The optimum temperature required for its growth varies from 15 to 27°C. Cowpea can be grown on a wide range of soils from heavy to sandy loam with a pH range of 5.0 to 6.5. Saline, alkaline or waterlogged soils should be avoided. Heavy clays encourage vegetative growth with less seed production.

Cowpea for fodder purpose can be grown in any month if irrigation facilities exist. In Kerala, it is raised as a rainfed crop during May and also as summer crop in rice fallows.

Two to three ploughings are required to produce a coarse seedbed for the crop.

Shallow furrows at 3 m apart for leading irrigation water may also be provided. It can be broadcasted or drilled in lines. For seed crop, line sowing is preferred. Seed rate recommended is 40 to 50 kg ha<sup>-1</sup> for a broadcast crop and 15 to 40 kg ha<sup>-1</sup> for drill sown crop. For drilling, spacing of 30 to 40 cm between rows and 6 to 15 cm between plants is recommended.

For rainfed crop, at the time of land preparation, FYM @ 10 t ha<sup>-1</sup> is applied and basal application of N, P<sub>2</sub>O<sub>5</sub> and K<sub>2</sub>O @ 25, 60 and 30 kg ha<sup>-1</sup> is recommended. For irrigated crop in addition to the basal dose of 40: 30: 30 kg N: P<sub>2</sub>O<sub>5</sub>: K<sub>2</sub>O ha<sup>-1</sup>, topdressing of N and K<sub>2</sub>O each at 10 kg ha<sup>-1</sup> after each cut is to be given.

A pre-sowing irrigation is important for the proper germination of the crop. If there is lack of soil moisture, shallow irrigation at 3-4 cm depth once in 15 days during summer and once in a month during post-monsoon period is good.

One or two weeding may be required in the early growth stages to combat weed problems. Usually high seed rates are effective in smothering weeds.

Cowpea is tolerant to moderate shade. So it can be successfully grown as intercrop with maize, sorghum, bajra, guinea grass, napier grass etc. to get high yields. In Kerala cowpea is also raised as an intercrop in coconut gardens.

As a fodder crop, the first cutting can be given 45 days after planting and subsequent two cuttings at 30 days intervals. A single cut crop yields 25 to 30 t ha<sup>-1</sup> whereas green matter yield of 40 t ha<sup>-1</sup> is obtained from multi-cut cowpea.

Cowpea is used as fodder crop for green feeding, hay-making, grazing and also for ensiling in mixtures with sorghum or maize. The grains are used as human food as well as animal feed. Cowpea is also used as green manure crop and as cover crop in plantations. The feeding value of cowpea forage is high. It is superior to other legumes like soybean because of its low fibre content and minimum wastage in feeding livestock. It has about 16 per cent crude protein and 20 per cent crude fibre.

Cowpea is a self-pollinated short day plant. The percentage of hard seed is low and viability under storage lasts for 3 years.

## STYLO (*Stylosanthes* spp.)

*Stylosanthes* is a genus of summer growing perennial pasture / fodder legumes. Most of its species are native of south and central America and the Caribbean Islands. This is a fodder cum leguminous cover crop, which is suited for intercropping in coconut gardens, either alone or in combination with other fodder grasses. The crop controls soil erosion by giving a protective soil cover. It also helps to smother weed growth.

The genus *Stylosanthes* consists entirely of herbs and small shrubs. Usually they have a crown of growing points near the soil surface. This enables the plants to overcome the excessive damage caused by grazing animals. They have indehiscent seeds, regulating dormancy. The seed has hooks for dispersal through animals. The seeds can also pass through the digestive system of animals. In some species due to the presence of viscid hairs, they are not eaten in some

seasons of the year. The plant thrives well in light soils due to its deep rooting system.

The crop is suited for growing in warm, humid tropical climate. It is fairly drought resistant and shade tolerant. It can be cultivated in areas receiving less than 1000 mm of rainfall and in less fertile soil, acid soils, gravelly sandy soils and also in ill-drained soils.

In humid tropical environments, *S. guianensis* thrives very well and can withstand flood and drought lasting for short periods. Germination and growth are favoured at high temperatures.

In less fertile soils like sandy coastal soils, phosphorus fertilizers should also be added along with sowing of seeds so as to help the development of root nodules.

Sowing is to be done with the onset of southwest monsoon during May-June. Irrigation is required if there is no proper soil moisture at the time of sowing.

The following are the perennial types of *Stylosanthes*, ideally suited for growing in the state.

**Brazilian lucerne (*Stylosanthes guianensis*)** : This is used as a pasture legume in a number of tropical countries; Varieties are usually erect to semi-erect. They are generally not profusely branched at the base. It can grow up to 1.5 m in height, particularly when it gets support from the associate grasses. The trifoliate leaves are long, rather narrow and pointed. The stems are coarse and hairy. In some of the varieties the leaves are sticky. The flowers are small and yellow producing single seeded pods. It does not tolerate shade and can grow very well in areas receiving 900 to 4000 mm of rainfall. It is very tolerant to low fertility, but responds well to phosphate and is sensitive to copper deficiency. Stylo seed

should not be sown below 7 to 13 mm. A seed rate of 2 kg ha<sup>-1</sup> is usually satisfactory. Although Stylo is usually nodulated by naturally occurring *Rhizobium* strains, these however, will not be as effective as the commercial strains. The main variety commercially grown is Schofield. This is an erect variety and very late in flowering. Other varieties are Cook, Endeavour and Graham.

**Townsville stylo (*Stylosanthes humilis*)** : This annual type stylo is also found suitable for growing in Kerala.

**Caribbean stylo (*Stylosanthes hamata* cv. Verano)** : This is a short-lived perennial legume similar to Townsville stylo. It is slow growing and develops a flat crown under grazing. Erect stem may grow up to 80 cm. The stems of Verano are smooth. As against the bristly stems of Townsville stylo it has a line of very fine, short white hairs on one side only. The flowering spike of Verano produces double seeds; the upper has a reduced hook about 3 to 5 mm long, while the lower seed has no hook. Verano combines many of the virtues of both annuals and perennials.

**Shrubby Stylo (*Stylosanthes scabra*)** : This is a perennial shrub. Its deep root system enables the plant to remain green even in very dry season. The recommended varieties of shrubby stylo are Seca and Fitzroy.

Seeds of stylo are very small. The seed rate is 2 to 3.5 kg ha<sup>-1</sup> when grown as an intercrop in coconut gardens. For grass legume mixtures, 1.5 kg ha<sup>-1</sup> is sufficient. Seeds are soaked in water overnight and mixed with *Rhizobium* culture before sowing.

Prepare a fine seedbed. Seeds are mixed with sand when sown as a pure crop or mixed with grass seeds for mixtures. Seeds are sown broadcast and covered with thin layer of soil or dibbled at a spacing of 30 cm

between rows. The depth of sowing should be 5-10 mm. Seeds germinate within a week.

The variety Cook produces seeds well. A seed rate of 5 kg ha<sup>-1</sup> is better for seed production. Apply phosphorus @ 120 kg and lime @ 375 kg per ha for maximum yield. For seed production, irrigate with 33 mm of water once in 9 days during summer months from January to March. A total of 10 such irrigations are required during the period.

Recommended dose of N, P<sub>2</sub>O<sub>5</sub> and K<sub>2</sub>O for both annual and perennial stylosanthes are 20, 80 and 30 kg per ha respectively. For perennial crops, phosphorus @ 80 kg ha<sup>-1</sup> and potash @ 30 kg ha<sup>-1</sup> may be applied in

subsequent years. Application of lime @ 375 kg ha<sup>-1</sup> is also recommended in acid soils.

Gap filling may be done 15 days after sowing. First weeding is given 45 days after sowing. A second weeding and hoeing may also be done after the first harvest. Gentle raking of the interspace after the application of fertilizers in the subsequent years may be done.

First harvest is taken 3-4 months after sowing and subsequent harvest at 45 days intervals or according to the growth of the crop. A maximum of 4-5 harvests can be taken in a year for a perennial crop, which will remain in the field for 3 years. The crop yields 25-30 t ha<sup>-1</sup> green fodder per year.

## FODDER CEREALS

### FODDER MAIZE (*Zea mays*)

Maize grows best in warm climate where the day temperature is fairly light. Heavy rains and dry hot winds are not suitable. Favourable annual rainfall is 60-100 cm. The crop comes up well in soils with good drainage and fair moisture status.

The optimum season for sowing is the last week of June to second week of July and September to October. The crop can be raised throughout the year in areas where irrigation facilities are available. The land is ploughed two or three times and beds and channels are formed. Seeds can be either broadcasted or dibbled at a spacing of 30 cm between rows and 15 cm between plants.

Hybrid varieties are Deccan, Ganga-5, Ganga safed-2, and Ganga-3 and composite variety Vijay.

Seed rate for broadcasting is 80 kg ha<sup>-1</sup> and for dibbling 40-60 kg ha<sup>-1</sup> (to be dibbled at 5-6 cm depth @ two seeds per hole).

FYM @ 10 t ha<sup>-1</sup> may be applied at the time of preparation of land as basal dressing. N, P<sub>2</sub>O<sub>5</sub> and K<sub>2</sub>O at the rate of 120, 60 and 40 kg/ha respectively, may be given as topdressing. Weeding may be done according to necessity.

First cutting of maize can be taken after 60 days of planting or at the milky stage of the crop. A second cut can also be taken if there is sufficient moisture in the soil.

## FODDER SORGHUM (*Sorghum* sp.)

Fodder sorghum is an ideal tropical forage crop. It is fairly drought resistant and suited for areas where moisture is a limiting factor for crop growth. The crop can be raised during both monsoons. All soils except sandy

soils are suited for the crop. Apply N, P<sub>2</sub>O<sub>5</sub> and K<sub>2</sub>O fertilizers @ 60, 40 and 20 kg per ha, respectively. Important varieties are M.P.Chari, MPKV-1, JS-20, S-1049 and JS-3.

## GREEN MANURE CROPS

### Sunn hemp (*Crotalaria juncea*)

It is a vigorous growing green manure crop, which can be incorporated at 10 weeks after sowing. It does not withstand waterlogging. The seed rate is 25-35 kg ha<sup>-1</sup>. The green matter yield is 15-20 t ha<sup>-1</sup>. Quantity of nitrogen fixed by the crop is 75-80 kg ha<sup>-1</sup>.

### Daincha (*Sesbania aculeata* and *S. rostrata*)

#### *Sesbania aculeata*

It is a quick growing succulent green manure crop, which can be incorporated at about 8 to 10 weeks after sowing. This crop adapts to varying conditions of soil and climate. It can be grown even under adverse conditions of drought, waterlogging, salinity etc. Recommended seed rate is 20 to 25 kg per ha. The green matter yield is 10-20 tonnes per ha. Quantity of nitrogen fixed is 75 to 80 kg per ha.

#### *Sesbania rostrata*

It is a green manure crop, which has nodules both on the stem and root. It thrives well under waterlogged condition. The normal seed rate is 30 to 40 kg per ha. To get early, uniform germination and vigorous seedlings, seeds have to be scarified with concentrated

sulphuric acid for 15 minutes and then washed thoroughly with fresh water and sown immediately. A green matter yield of 15 to 20 t ha<sup>-1</sup> equivalent to 150-180 kg N ha<sup>-1</sup> is obtained within a period of 8 to 10 weeks.

### Wild indigo or kolingi

#### (*Tephrosia purpurea*)

It is a slow growing green manure crop suitable for light soils. It resists drought but does not withstand water stagnation. The seed have a waxy, impermeable hard seed coat and do not quickly germinate. To hasten germination, the seeds are to be abraded with sand or steeped in hot water at 55°C for two to three minutes. The seed rate is 20-25 kg ha<sup>-1</sup> and the green matter yield varies from 8 to 10 t ha<sup>-1</sup>. When kolingi is sown in an area for two or three seasons continuously, scattered seeds will give rise to volunteer plants and there is no need for further sowing.

### Indigo / Bengal indigo

#### (*Indigofera tinctoria*)

Indigo resembles kolingi, but has more leafy habit. It shows resistance to drought. Better yield is obtained when two irrigations are given and when grown in clayey soil. Seed rate is 20 kg ha<sup>-1</sup>. Green matter production is 8-10 t ha<sup>-1</sup>.



## GREEN LEAF MANURE CROPS

### Gliricidia (*Gliricidia maculata*)

It is a shrub, which takes up a tree habit under favourable conditions of soil and climate. For green leaf purposes, the shrub should be kept low by pruning or lopping at a height of 2-3 m. The shrub can be pruned two or three times a year and it withstands repeated lopping. Within two years after planting, the plants are ready for lopping. Each plant gives 5 to 10 kg of green leaves annually.

### Subabul (*Leucaena leucocephala*)

This species, a native of Central America, occurs as a branched shrub. It is a promising forage tree crop, the leaves of which contain about 3-4 per cent of N. *Leucaena* fixes about 500-600 kg N ha<sup>-1</sup> per year.

### Cassia (*Cassia auriculata*)

Propagated by seeds. During flowering tree is topped (stem and branches cut) and loppings used for green leaf manuring.

## AGROFORESTRY

Agroforestry refers to land management systems that integrate agricultural crops with forest crops. It is a collective term for all land use systems and practices in which woody perennials are deliberately grown on the same land management unit as crops or animals, either in some form of a spatial arrangement or in a time sequence and in which there is a significant interaction between the woody perennials and the crops or animals.

### Types of Agroforestry

The major classes of agroforestry include, agrisilviculture, silvopastoral, agrosilvopastoral and other (miscellaneous) systems.

Agrisilviculture refers to systems in which agricultural crops are integrated with trees on the same land management unit either in time or space. Examples include taungya, alley cropping, multipurpose trees either as woodlots or as scattered trees on farmlands or on farm boundaries, crop combinations involving woody perennial plantation crops, growing commercial crops in association with planted shade trees or trees in natural forests, shelterbelts, energy plantations, enriched fallow and so on.

Silvopastoralism represents land management systems in which forests including forest plantations are managed for the

concurrent production of wood and livestock. They also refer to situations in which trees are scattered in pasture/grasslands, protein banks/cut and carry fodder production system involving woody perennials and the like.

Agrosilvopastoral systems, the most intensive form of land management, are systems in which the land is managed concurrently for the production of agricultural and forest crops and for rearing of domesticated animals.

In addition, there are many agricultural practices associated with forest that strictly do not fall under the above categories. These include, collection of non-timber forest products from forests, growing trees around wetlands and other water bodies in which fish culture is practised, apiculture with trees and multipurpose woodlots etc.

### Trees in Agroforestry

Many tree species (woody perennials) are encountered in agroforestry. These include common timber species such as ailanthus (matti), teak, wild jack and multipurpose tree species such as mango, jack, tamarind, erythrina, gliricidia etc. Species-specific recommendations for some important timber (softwood and hardwood) trees are given below.

## AILANTHUS OR MATTI (*Ailanthus triphysa*)

*Ailanthus* trees flower in February-March and the fruit, a reddish brown samara, ripens in March-April, which represents the ideal time for seed collection. The seeds can be stored only for a few months. Alternate wetting and drying improves seed

germination. The procedure involves soaking the entire quantity of seeds in cold (room temperature) water in the evening and draining the water next morning, followed by drying the seeds under shade during the day. The cycle is repeated for two to three days.

### Nursery practices

Raised beds of 10 m x 1 m are formed. Preferably sand, soil and FYM (1:1:1 ratio) must form the top layer of the beds. Sowing is done after the bed is watered. Usually sowing is done by broadcast method (or dibbling) in Nov-December, for June planting and March-April, for October-November planting. After sowing, a thin layer of soil is sprinkled on the beds to cover the seeds. The beds are also mulched with green leaves to reduce the evaporation losses and dusted with carbaryl 10 per cent to prevent insect attack. Seed rate is 1 kg per bed. After sowing, watering is done with a fine rose-can twice a day for 10-15 days and once a day afterwards. The nursery beds also must be weeded as and when necessary.

### Pricking out

Germination takes place in about 8-10 days after planting and the seedlings attain a height of 10-15 cm in six weeks time. They are then pricked out into polythene bags containing 1:1:1 mixture of sand, soil and FYM.

### Planting practices

Containerised stock (commonly in polybags, but also in root trainers) is planted in pits (15-20 cm cube) at 2 m x 2 m spacing with the onset of rains, in the case of monospecific woodlots. To suit the requirements of intercropping, the row-to-row spacing can be altered. *Ailanthus* is ideal for planting in the

homestead or farm boundaries either in single or staggered paired rows at a spacing of 2.5 m x 2.5 m.

Two to three weedings may be necessary in the initial years to keep the plantation weed-free. Fertilizers may be applied @ 30-40 g N, 15-20 g P<sub>2</sub>O<sub>5</sub> and 15-20 g K<sub>2</sub>O per year per sapling from the second year to the fifth year and thereafter once in three years for a pure plantation.

In case too many lateral branches are produced, pruning may be practised. The trees can be felled/harvested over a period of 8 to 10 years.

### Pests

Nursery: The two major pests are shoot webber (*Alteva fabriciella*) and defoliator (*Eligma narcissus*). Shoot webber is economically more important because it will damage the terminal shoot and can result in epicormic branch formation. It can be controlled by application of quinalphos at 0.05 per cent.

Young plantations: The above two are the major pests in young plantations also, but control measures may not be cost effective. If required, 0.1 per cent quinalphos can be applied using rocker sprayer. Shoot webber affects seed production. Usually control measures are not adopted but any insecticide, which is recommended under the nursery, can be used.

## CASUARINA (*Casuarina equisetifolia*)

*Casuarina* is a large evergreen tree with a straight bole and numerous, long, slender, drooping, jointed, leafless branchlets arising from rough woody branches. The jointed branchlets, which are partly deciduous, are

green and perform the functions of leaves. Leaves are minute scale like and arranged in the form of a cup at the joints of the branchlets. Bark is brown, rough, fibrous and exfoliating in longitudinal strips. Wood is very

hard, but liable to crack and split. It is used as timber, poles, pulp and paper besides fuel-wood. Casuarina is grown as an ornamental tree throughout the tropical and subtropical parts of India. In addition, it can be grown in agroforestry combinations involving diverse crops. Fodder grasses, other agronomic crops such as pulses, oil seeds and vegetables, coconut palms and tree crops such as teak and ailanthus are important in this respect.

#### Propagation

Propagation is by seeds or through vegetative means. For seedling production, about half kg seeds are sown on raised nursery beds of 10 m x 1 m. This will produce about 10,000 good quality seedlings. If the soil is sandy, mix farmyard manure with the topsoil. After sowing the seeds, a thin layer of sand is sprinkled to cover the seeds. Usually sowing is done in Nov-December. Regular watering and shading of the nursery beds are necessary to facilitate rapid seed germination. Germination takes about 10 days and seedlings attain a height of 10-15 cm in 6 weeks. They are then pricked out into polythene bags or transplanted into beds of size 1 m x 10 m in January-February.

Vegetative propagation is by branch cuttings, stump cuttings and layering. For vegetative propagation by rooting of branch cuttings, treat 5-7 cm long cladode cuttings with rooting hormones. The hormone-treated cladodes are transferred to presoaked vermiculite and kept in a mist chamber. About hundred per cent rooting is obtained within 15 days. The rooted cuttings are then transferred to a mixture of sand, soil and farm yard manure (2:1:1) for hardening. After 15 days, the hardened propagules can be transferred to the field.

#### Planting and stand management

Casuarina has a wide environmental adaptability and hence occupies sites

ranging from arid regions to coastal zones. Being an actinorhizal plant, casuarina is capable of biological nitrogen fixation. Therefore, it thrives best on sandy soils low in nitrogen and has the potential to improve the nitrogen capital of impoverished sites.

Site preparation includes ploughing the land 2-3 times and making 30 cm x 30 cm x 30 cm pits before the onset of monsoon. The pits are filled with FYM and topsoil. Planting is done immediately after the first rain. Block planting, row planting and line or strip planting are common. Spacing varies depending on the objective and the end product. Usually a spacing of 75 cm x 75 cm is adopted. One or two weeding is done immediately after the rains. When the trees are about 3 m in height, the lateral branches are pruned to a height of about 2 m. Pruning is usually done at the end of the second year or after the beginning of the third year. In plantations established at close spacing (75 cm x 75 cm), one thinning in the second year or third year depending on tree growth is desirable, where 25-50 per cent of the trees are felled. In mixed species systems such as agroforestry, spacing and thinning practices are mainly dependent on the cropping systems and the nature of the associated species. If the associated crops are shade intolerant generally wider spacing and or intensive thinning are recommended. Fertilizers may be applied at the rate of 20-25 g N, 15-20 g P<sub>2</sub>O<sub>5</sub> and 15-20 g K<sub>2</sub>O per seedling per year from the second year to the fifth year.

#### Injuries and protection

Damping off, seedling blight, stem canker and seedling rot are encountered in the nurseries. Stem wilt or bark blister disease caused by *Trichosporium vesiculosum* is a serious disease in the plantations. The disease affects trees of 3-4 years and causes mortality up to 80 per cent.

Maintaining a soil pH of 6.5 to 6.8 and treating the plantation with fungicidal sprays can control this disease. Other diseases include stem canker and dieback caused by *Phomopsis casuarinae*, pink disease caused by *Corticium salmonicolor*, root rot disease caused by *Ganoderma lucidum* and heart rot caused by *Polyporus glomeratus*, *Fomes fastuosus* and *F. senex*. Stem canker and dieback can be controlled by spraying carbendazim @ 0.05 per cent.

Insect pest problems to the tune of regular

epidemic infestations inflicting extensive economic losses rarely occur in casuarina.

#### Harvest

Casuarina seedlings growing rapidly at the rate of about 1.2 to 1.5 m per annum during the initial seven to eight years are usually harvested in about 7-10 years. Yield of high density fuel-wood plantations varies from 10-20 tonnes per ha per year on 7-10 years rotations. Higher yields are reported from irrigated and fertilized sites.

## EUCALYPTUS (*Eucalyptus* spp.)

*Eucalyptus* is an Australian genus comprising of 140 species. They are evergreen species, all more or less aromatic and containing oil glands in their leaves. Mysore gum (*Eucalyptus tereticornis*), flooded gum (*Eucalyptus grandis*), blue gum (*Eucalyptus globulus*) and lemon-scented gum (*Eucalyptus citriodora*) are the important eucalyptus species grown in Kerala. Of these, Mysore gum and flooded gum are important timber species in the low- and mid-altitudinal zones of the state, respectively. The cultivation practices of these two species are described below.

*E. grandis* grows best in deep, permanently moist, well-drained soils. *E. tereticornis* also prefers moist and well-drained soils such as loamy sands or alluvial loams, with high nutrient availability. A certain degree of salinity is tolerated, but strongly acid soils are ill suited. *E. tereticornis* adapts to a variety of sites, but responds poorly to excessively long dry periods. It is very easy to regenerate both species and they are good coppicers. The number of seeds per kilogram for *E. grandis* is 2.5 million, whereby roughly 630 viable seeds can be expected per gram. In the case of

*E. tereticornis* one gram contains approximately 540 seeds.

#### Planting stock

Three-month-old containerized stock (polybag seedlings or root trainer seedlings) is recommended for planting. For seedling production, sow the seeds in seed tray in February. Trays should be kept moist with a fine spray of water until germination begins. Germination begins 7-9 days after sowing. The seedlings should be pricked out when they have two pairs of leaves into polybags of size 22 cm x 10 cm or root trainers. Planting stock of high yielding disease resistant clones are available at the KFRI / Kerala Forest Department nurseries.

#### Planting and stand management

Best time for planting is the beginning of rains. Planting is usually done in 20 cm x 20 cm x 20 cm pits (for clones use 30 cm cube pits) at 3 m x 3 m spacing. For production of pulpwood and fuel-wood, 6-10 year rotations are used without thinning. Depending on site conditions, *E. grandis* and *E. tereticornis* may respond to mineral fertilization with accelerated growth. Fertilizers may be

applied at the rate of 30 g N, 30 g P<sub>2</sub>O<sub>5</sub> and 15g K<sub>2</sub>O per sapling per year during the second, third and fourth years.

#### Injuries and protection

Polyphagous insects seem to attack the nursery stock. Quinalphos or malathion 0.05 per cent is recommended against them. Drenching the containers with chlorpyrifos is a preventive measure against termite attack in plantations. Quinalphos 0.05 per cent solution is recommended to control stem borer attack.

Cylindrocladium leaf blight and pink diseases are common in eucalyptus trees. To control Cylindrocladium leaf blight, spray carbendazim 1 g l<sup>-1</sup>. Bordeaux paste is

recommended against pink disease. Use disease tolerant clones for preventing the incidence of both diseases.

#### Uses

*E. grandis* wood is pink to pale reddish brown in colour. It has good bending properties. It is used for housing construction, floors, furniture, crates, and veneers, in the paper industry and as fuel-wood. *E. tereticornis* produces dark red wood. It is hard, strong, tough, heavy, very durable and resistant to termite attack. It is used for a wide range of construction applications, suited for trench linings and fuel-wood. *E. globulus* and *E. citriodora* leaves are used for commercial production of Eucalyptus oil.

## MANGIUM (*Acacia mangium*)

Mangium is a major fast-growing tree species in forestry plantation programmes in Asia and the Pacific. It tolerates varied site conditions and has adaptability to different planting objectives. Mangium shows most vigorous growth on well-drained, fertile soils in high rainfall areas (>2000 mm annually) in the humid tropics.

#### Propagation

Flowering in mangium is precocious. It starts to flower and produces seeds 18-20 months after planting. Pods can be collected from the trees in January-February under Kerala conditions, when the pods turn very dark-green to light-brown in colour. Seeds are extracted manually after sun-drying. Pods and seeds should not be left to dry in the sun for long. Store the seeds under dry and insect/rodent-free conditions. The number of seeds in one kg of pure seed varies among trees (mean: 125,000 seeds per kg).

#### Pre-sowing treatment and nursery practices

To break dormancy of mangium seeds, hot water treatment is recommended. The seeds are tied in porous cloth and immersed in near boiling water (90°C) removed from the heat source for not more than 30 seconds. Pour off the water. Add cold water (room temperature) 20 times of the seed volume. Let stand overnight to imbibe and sow the seeds in the nursery beds/seed trays. Seed inoculation with appropriate rhizobial strain is recommended before sowing. Mangium seedlings are ready for pricking out in 6-10 days after sowing. Polythene bags are the most common containers used in the tropics for pricking out. Mangium seedlings attain a target size of 25-40 cm height in about 12 weeks. Seedlings are hardened by progressively reducing watering and removing shade in the nursery. If the seedlings have grown larger than the target size in the nursery, they may be lopped.

### Planting and stand management

Planting is usually done in pits of 20 cm depth and 10-12 cm diameter. In monospecific stands, spacing of 2 m x 2 m or 2.5 m x 2.5 m is common. However, if saw-log production (large diameter stems) is the objective, wider spacing (3-3.5 m between rows and between plants) should be followed. In agroforestry situations, spacing within rows and between rows must consider the effect of shade and root competition on the yield of associated crops. Shade tolerant crops such as turmeric and ginger can be intercropped with Mangium trees planted at 2 m x 4 m or 4 m x 4 m spacing. The crops can be raised in one meter wide beds laid in between the planting rows of Mangium.

First weeding must be carried out two months after planting and thereafter at regular intervals depending on weed growth. On favourable sites, mangium plants emerge and dominate the weeds within two years, thus not requiring any further weed control. Fertilizers may be applied @ 30-40 g N, 15-20 g P<sub>2</sub>O<sub>5</sub> and K<sub>2</sub>O per seedling per year from the second year to the fifth year. Mangium needs regular pruning and thinning if the plantation objective is to produce quality sawlogs on 15 to 20 year rotation. These

operations in general are not required for pulp wood production on 6 to 8 years rotation. However, multi-stemmed seedlings may be 'singled'. In pruning, branches are carefully removed in one or more steps along the bottom trunk up to about 6-7 m height. For saw log production regimes is given as Table 33. Silvicultural schedule is recommended. The average wood yield per tree<sub>3</sub> on a 15 years rotation is about 0.7 to 1.0 m<sup>3</sup>.

### Injuries and protection

Although root rot disease caused by *Ganoderma* sp. (red rot), *Phellinus* sp. (brown rot) and *Rigidoporus lignosus* are major problems in mangium stands, there are no specific control recommendations against these fungi. Signs of the disease are evident on the roots after the tree has fallen or upon excavation. Depending on, which fungus causes the disease, there may be dark reddish granular rusty brown encrustation or white thread-like rhizomorphs on the surface of the rots. The usual method of controlling root rot caused by fungi that spread by root contact is to remove and destroy all diseased roots and woody debris.

Chemical protection against pink disease (*Corticium salmonicolor*), especially in

Table 33. Silvicultural management schedule for mangium saw log regime

Age	Activity	Remarks
4 months after planting	General slashing	Uproot all climbers within 45 cm radius of each plant. Remove branches at height less than 30 cm from the ground.
6 months after planting	General slashing	As above
12 months after planting	General slashing and first pruning	Remove all branches up to 1.5-2.0 m height.
2 years after planting	First thinning and high pruning	Remove 300 trees/ha, retaining 600 trees per ha. Prune branches up to 6 m height of the 200 selected trees (to be retained till end).
4-5 years after planting	Second thinning	Remove another 200 trees/ha retaining 400 trees/ha.
8-9 years after planting	Final thinning	Remove another 200 trees/ha.

endemic areas, can be achieved by using copper fungicides. The best way to prevent pink disease, however, is to plant tolerant varieties.

Progressive decay of the heartwood (heart rot) is another malady afflicting mangium trees. Normally, fungi that decay heartwood do not attack sapwood; such trees continue to grow to maturity and may outwardly appear healthy and vigorous. However, since heart rot is progressive, there will be considerable decay cull at the end of the rotation. A variety of basidiomycete fungi have been associated with this malady. At present there are no control measures against mangium heart rot. The best way is to avoid injury to trees and wound dressing.

Although about 30 insect species are reported to be pests of mangium, only a few such as root feeders, branch and stem borers and the red coffee borer are considered economically important. Root feeders (*Sermocera aequignata*) can be controlled by

chlorpyrifos application to the soil or seedbeds. To prevent branch and twig borer (*Sinoxylon anale*) occurrence, remove and burn all broken branches in which breeding takes place. The only effective method to control red coffee borer (*Zeuzera coffeae*) damage is to inject insecticide into the holes where larvae push out their frass.

#### Utilization of mangium wood

Timber is used for a variety of purposes like wood-based panels, pulp and paper industry etc. Mangium wood gives attractive furniture, cabinets, moulds and door/window components. However, the presence of flutes and incidence of rots and termite attack will detract both the quality and quantity of sawn timber from mangium logs. Therefore, mangium has greater potential as a component of composite wood products such as veneer and plywood, laminated veneer lumber, fibre boards etc. and for chemical uses such as pulp, paper and tannin production, besides fuel-wood.

## TEAK (*Tectona grandis*)

Teak is the paragon among Indian timbers. It is a large tree that attains a height more than 30 m. Teakwood is extensively used in construction, for making door/window shutters and frames, furniture, cabinets, railway coaches and wagons, and ship/boat building. It is an ideal wood for parquet and decorative flooring and excellent wood for wall panelling. The species is indigenous to India and the Southeast Asian region. In India teak is distributed naturally in the peninsular region. It prefers a warm moist tropical climate with mean annual precipitation of 1100-2000 mm and a well-drained fertile soil.

Being a strong light demander it does not tolerate overcrowding and does not withstand waterlogging.

#### Propagation

Seeds (fallen fruits) should be collected from vigorously growing middle-aged trees characterized by straight boles, desirable branching habit, good form and less fluting. Freshly fallen intact fruits with inflated calyx from such trees can be collected during December-February. The ground must be cleared before hand by removing litter and other materials to facilitate seed collection.



After cleaning and drying the seeds may be safely stored in gunny bags or sealed containers. Seeds of diameter greater than 9 mm are usually collected. For convenience in storage and transport, the bladder like calyx of the fruit is removed. This is done by half-filling a bag with the fruits and vigorously rubbing and shaking it or by beating with sticks, after which the remains of the calyces are separated from the nuts by winnowing. Due to hard seed coat, germination of one-year old seeds is better than that of fresh seeds.

#### Pre-sowing seed treatment

1. Teak seeds kept in jute sacks should be soaked in water during night time and dried in sun during day time. This practice is to be continued for one week.
2. Termite feeding: Spread the teak fruits on the ground in a 5 cm layer immediately after collection. After about five weeks the termites remove the exocarp and subsequent germination after alternate wetting and drying is found to be better.

#### Nursery practices

Raised beds (30 cm high, supported with split areca stems) of 10 m x 1 m are formed. Sand and soil mixed with FYM form the top layer. Sowing is done after the bed is watered. Usually the sowing is done by broadcast method or dibbling in April-May. Seed rate is 3-5 kg of seeds per bed. After sowing, the seeds may be pressed into the beds. A thin layer of soil also can be sprinkled to cover the seeds. The beds are also mulched with green leaves to reduce evaporation losses. The bed is then dusted with carbaryl 10 per cent to prevent insect attack. Traditional mulching materials may be substituted with a single layer of newspaper.

One-year-old seedlings of 1-2 cm (thumb thickness) at the thickest portion below the collar are uprooted from mother beds and used for making stumps. Stumps with 15-20 cm of root at 2-3 cm of stem prepared with sharp knife are commonly used for planting. Teak seedlings can be produced in shorter duration by using polythene bags or root trainers. Three to four month old teak seedlings are pricked out from the germination beds into polythene bags (30 cm x 20 cm) in the month of March/April. Three-month-old root trainer seedlings are also popular, of late.

#### Planting

With the pre-monsoon showers, stump planting is done in crowbar holes during April-May (four to six weeks before the onset of regular monsoons). The site must be cleared of stubble or other competing vegetation, if any. If containerized planting stock (polybags, root trainer) is used, then optimal time of planting may be after the onset of southwest monsoon in June-July. They are usually planted in pits of size 30 cm x 30 cm x 30 cm. Spacing recommended for monospecific woodlot is 2 m x 2 m. However, if intercrops are proposed to be raised, then row-to-row distance can be altered. For one or two row strip plantings at farm boundaries, a closer plant-to-plant spacing of 1 m could be employed initially and later thinned to attain better size.

#### Weeding and fertilization

Six or seven weeding may be necessary during the first two years. Teak is very susceptible to weed competition. Fertilizers may be applied @ 30-40 g N, 15-20 g P<sub>2</sub>O<sub>5</sub> and 15-20 g K<sub>2</sub>O per plant per year from the second year to the fifth year and thereafter once in three to four years for 10-12 years. In agroforestry situations, if the intercrops are

fertilized, the quantities of chemical fertilizers applied to teak can be proportionately reduced or even skipped. Providing life-saving irrigation during the summer season favours teak growth.

#### Thinning

For a fifty-year rotation, monospecific teak plantation on a good site (initial spacing 2 m x 2 m), thinning may be carried out at 4, 8, 12, 18, 26 and 36 years after planting. Thinning in short rotation (25-30 years) high input plantations can be at 4, 8, 12 and 16 years. The thumb rule governing thinning is that trees should not be allowed to compete with each other for site resources, as intense competition may depress teak growth. Therefore, considering the site characteristics, tree growth rate and merchantability of the thinned out materials, a flexible thinning schedule can be adopted. A teak density management diagram can be used for this purpose. In general thinning is delayed on poor sites.

#### Mixed plantations

Fruit/spice/medicinal trees also can be successfully intercropped with teak throughout its growth. Additionally, inclusion of nitrogen fixing trees such as *Gliricidia* or *Leucaena* (subabul) either in alternate rows or every third row not only improves teak growth but also saves chemical nitrogenous

fertilizers. However, manage (by lopping or pruning) the nitrogen fixing tree component in such a way that it does not compete with teak for light.

#### Pests, diseases and their control

White grubs feed on roots in the nursery. Vascular wilt disease (*Burkholderia solanacearum*) is noticed in nursery and young plantations. As preventive measures against this disease, maintain proper drainage and avoid root injury. Leaf spot disease (*Phomopsis* sp. and *Colletotrichum gloeosporioides*) in nursery and young plantations can be controlled by carbendazim 0.05 per cent application. Against pink disease (*Corticium salmonicolor*) in young plants, apply Bordeaux paste.

Defoliators (*Hyblaea parea*) and skeletonisers (*Eutectona machaeralis*) can be controlled by quinalphos 25 EC 0.05 per cent spray. However, only in small plantations / woodlots chemical control through insecticide spray is advocated. For controlling stem borer (*Sahyadrassus malabaricus*) apply 0.2 per cent quinalphos at the site of infection after removing the frass. Avoid injury to root and collar to prevent bud rot and heart rot occurrence. Cut and remove the parasitic plants (*Dendrophthoe falcata* var. *pubescens*) before fruiting.

## THORNY BAMBOO (*Bambusa arundinacea*)

Bamboos are woody perennial grasses that occur in the tropical and subtropical evergreen and deciduous forest formations of Asia-Pacific. Important uses of bamboo include paper and pulp industry, fuel, food, feed, house construction and scaffolding, making several articles of everyday use, besides

controlling soil erosion. One hundred and thirty wild and cultivated bamboo species are reported to occur in India. They exist under diverse ecological conditions, often as an under-storey in many forest types. In agroforestry, thorny bamboo is perhaps the most important species in Kerala.

## Propagation

Bamboos are propagated either by seeds or vegetative means (offsets, division, culm/rhizome cuttings or layering). In general, bamboos are monocarpic, i.e. they flower only once and die after producing seeds. Most of the economically important bamboos flower gregariously at long intervals of 30-40 years. Although large quantities of seeds are produced during gregarious flowering, they are viable only for about six to eight months. Seeds can be germinated in nursery beds and pricked out into polybags of size 18 cm (flat width) x 22 cm. One year-old seedling can be used for planting. However, when seeds are not available, bamboos are propagated vegetatively.

Propagation by offsets is the common method of vegetative propagation. One-year-old culms in a clump are given a slanting cut at about 90 to 120 cm above the ground. The rhizomes to which they are attached are dug out with the roots intact. The shoot portion is then cut off to a length sufficient to include a well-developed bud. These offsets are planted out sufficiently deep in the soil to cover the first two or three nodes. Planting should be carried out immediately before the rainy season. During extraction care must be taken to avoid damage to roots and rhizomes of mother clumps.

Work at the KFRI has shown that using rooted culm cuttings is a viable alternative to the laborious offset method. For vegetative propagation using culm cuttings, extract 2 to 3 year old culms from healthy clumps by cuttings just above the first node during March-April. Trim the leaves and side branches without injuring the axillary buds. Prepare two-node cuttings (leaving about 5-7 cm on either side of the nodes) using a sharp knife or saw. Make a small slit (about 2 m long and 1 cm wide) or drill holes (about 7 mm diameter)

in the middle of the inter node. Wrapping in moist gunny bag or embedding in boxes containing moist saw dust might minimize exposure of the cuttings. Pour about 200 ml of NAA (1-naphthalene acetic acid) solution (100 ppm) carefully into the culm cavity through the slit and close the slit/hole by wrapping with a polythene strip. Ensure that the polythene wrapping is tight so that the solution does not leak out. After extraction, the culm cuttings should be treated with NAA as quickly as possible.

Prepare raised nursery beds of 10 m x 1 m and fill with a mixture of soil and sand (3:1). One week prior to planting, drench the nursery bed with 30 litres of carbendazim 0.05 per cent to prevent fungal attack. Place the cutting horizontally (the opening facing upwards) across the nursery bed. About 50-60 cuttings may be conveniently planted in a raised nursery bed. Cover the cuttings with a thin layer of soil. Provide shade and water the beds regularly till the onset of monsoon but avoid waterlogging. Rooted cuttings can be transplanted to the field in about four months. Cuttings sprouted and rooted at both the nodes of a culm cutting must be separated carefully through the middle to get two plants.

Propagation by division is usually done in the case of dwarf bamboos, which are easy to handle. It involves splitting/dividing the mass of rhizomes and planting out the culms in small clumps with two or three culms attached. Other methods of vegetative propagation include rhizome cuttings and air layers. Sections of fresh living rhizome of the preceeding year about 15 to 30 cm long containing at least one bud and air layers form successful means of propagating some bamboo species.

## Planting and fertilization

Spacing recommended for mono-specific

bamboo plantations is 10 m x 10 m. Propagules can be planted in pits of size 45 cm x 45 cm x 45 cm. Fertilizers may be applied @ 40 g N, 10 g P<sub>2</sub>O<sub>5</sub> and 75 g K<sub>2</sub>O per plant per year in 1-2 year old plantations.

#### Competitive interactions in bamboo-based agroforestry

Being perennial grasses, bamboos have higher root length densities than dicots. Thus in mixed species system, bamboos may out-compete the field crops or other tree crops grown in association. However, interspecific competition in bamboo-based agroforestry systems can be overcome by planting crop 8-9 m away from the bamboo clumps. Trenching (30-40 cm wide and 50-60 cm deep at 5-6 m away from the clumps) to spatially isolate bamboo roots from the rest of the crops is recommended, if crops are to be planted at shorter distances. Bamboo root competitiveness is usually a function of its rooting intensity with crown radius. Larger clumps have wider foraging zones usually extending to about 8 to 9 m. Therefore canopy reduction treatments such as pruning and culm thinning are appropriate to surmount interspecific competition. Pruning up to a height of 1.5 above the ground is recommended in plantations of

four year and above. Also remove the dry and dead culms from the centre of the clump to reduce congestion.

#### Pests and diseases

The bamboo plantations in Kerala do not face any serious insect problems. Young plants, however, are likely to be affected by shoot borers and sap suckers. In bamboo nurseries, damping off caused by *Rhizoctonia solani* is a major disease. It can be controlled by prophylactic fungicidal treatment and by regulation of shade and watering. In young plantations, rhizome bud rot (*Pythium* sp., *Fusarium* sp.), rhizome decay (*Pseudomonas* sp.) and basal culm decay (*Fusarium* sp.) are important.

#### Extraction of bamboo culms

Either all the old culms, i.e. those more than three years old (six years in the case of clumps regenerated from seedling) or a certain number of mature culms are removed annually. Older culms in the interior of the clumps should be removed in a horseshoe pattern. The height of cuttings is usually at 30-50 cm above ground. It is necessary that cuttings should leave at least one node above the ground to prevent rainwater soaking into the rhizome.

### WILD JACK OR AINI (*Artocarpus hirsutus*)

Ideally suited for boundary planting and as scattered trees on the farm field.

Performance under monocultural situations is not promising. Seeds or wildlings (scattered seedlings found profusely on

the farm fields) can be collected during the monsoon season and planted at the desired spots in the field. On farm boundaries, closer plant-to-plant spacing (1 m) can be adopted.

### ROSEWOOD (*Dalbergia latifolia*)

Rose wood is an important timber yielding tree of South India. It is the costliest timber in the world trade. It varies in size according to locality and attains its maximum growth in the

southern region of Western Ghats. It reaches to a maximum height of 40 m and a girth of 6.0 m. Uncontrolled felling caused the widespread removal of rose wood from our forests.

Wayanad district of Kerala is famous for the abundance of rose wood trees.

#### Artificial Propagation

Propagation is possible both by direct sowing and by planting seedlings, root suckers and sections of lateral roots. Stump planting of nursery seedlings is favoured, particularly in the west coast. Mature pods are collected from the trees during November-December. For direct sowing it is advisable to break the pods into one seeded parts. It can be stored up to 6 months after sun drying. Seed weight is 18000 seeds/kg. Soaking in cold water for 24 hours before sowing will result in 80 per cent germination. Instead of direct sowing, nursery raised seedling or stumps are also used to raise plantations. Seeds are sown in raised nursery beds during rainy season. Seeds start germinating within one week. The beds are regularly watered and weeded. One year old seedlings are used to prepare stumps. Stumps are prepared by pruning shoots having a diameter of more than 3 cm and roots at a length of 30 cm. Seedlings of 30 cm tall, 3 cm collar diameter, 30-40 leaves, 10-15 cm root length are normally transplanted. Through tissue culture, good planting materials can be produced which was proved by the research work carried at the Kerala Agricultural University, College of Forestry. During initial years, the seedlings should be protected from weeds, cattle and fire.

#### Natural regeneration

Under natural conditions, regeneration by seeds and root suckers takes place. Wind dispersed seeds will germinate in the early part of the rainy season. The conditions favourable for seed germination and seedling growth are moderate shade, loose and fairly

moist soil. For the further development of saplings overhead light is necessary. The seedlings should be protected from fire, weeds and cattle. The tree produces a large number of root suckers from its long, horizontal, superficial root branches. Root suckers can also be used for propagation. Wounding of roots by digging around trees stimulates root sucker production.

#### Planting and stand management

Saplings of rosewood can be planted in pits of 30 cm cube made at a spacing of 5 x 5 m. Pits are taken before the onset of monsoon and filled with 5 Kg of FYM and top soil. Initial growth of tree is found to be relatively low. Even though habitat is deciduous, it is evergreen in the moist zone of its distribution. In dry areas it shed leaves during February-March and then flushes soon. White flowers will be produced during January-February. Fruit will start developing during March and takes 7-8 months to mature. It is drought resistant. It stands a fair amount of shade, especially when young, but benefits greatly by overhead light. In too open situations, it tends to become crooked and branchy. Though it can withstand fire, fire protection measures are beneficial for the economic development of Indian rose wood forests. The growth of the tree is very slow. It thrives best on well drained, deep, moist soil, particularly in the neighbourhood of perennial streams. Weeding particularly during the early stages are recommended. Depending up on the age and size, about 50-70g of N, 30-50 g P<sub>2</sub>O<sub>5</sub> and 30-50g K<sub>2</sub>O along with 30 Kg of FYM per plant is applied from second year onwards during monsoon.

#### Plant protection

Fungi belonging to the genus *Polystictus*, *Schizophyllum*, *Trametes* etc. produce rot

diseases. Damping off disease by *Phytophthora* is also common particularly in nursery which can be controlled by drenching Bordeaux mixture 1 per cent. Pests of Coccidae and Membracidae family also attack these plants. Shoot webber *Atteva* sp. and defoliator *Eligma* is seen in some places which can be controlled by Quinalphos 0.05 per cent.

#### Timber

The sapwood is narrow and pale yellowish white in colour, often with a purple tinge. The heart wood ranges in colour from golden brown through shades of light rose, purple with darker streaks to deep purple with rather distinct black lines, darkening with age. It is fragrant, heavy, narrowly interlocked grained and medium coarse textured. The timber is stronger and much harder than teak and has a

slightly higher elastic limit than Burma teak. Harvesting is done after 60-70 years. One cubic meter wood weighs about 880 kg.

#### Uses

Indian rosewood ranks among the finest woods for furniture and cabinet work. It is also a valuable decorative wood suitable for carving and ornamental ply boards and veneers. It is used for making windows, doors, agricultural implements etc. It is grown in coffee plantations as a shade tree. The bark of the tree contains tannin. Parts of the tree are reported to be useful as stimulant and appetiser and also used for the treatment of dyspepsia, diarrhoea, leprosy, obesity etc. Leaves are used as fodder. It increases the soil nitrogen content. So it is used in agro forestry and social forestry programmes.

## SANDAL (*Santalum album*)

Sandal is a beautiful sacred tree and has been widely described in the ancient Hindu scriptures and epics. The tree is a native of India. This crooked thin branched evergreen tree is one of the costliest timbers. The world famous sandal wood oil is extracted from its heartwood. Full grown trees will attain about 12-13 m height and 1-2 m diameter. It is found in most parts of India. Sandal, which is distributed from sea level up to about 1800 m height, is found to grow in a variety of soils. Sandal which grow on sandy soil are more fragrant. Places where average annual rainfall is about 700-1600 mm is best suited for its growth.

#### Artificial propagation

Usually nursery raised seedlings are transferred to field. Pods are collected during the month of April, May, September and October. Collected pods are soaked in

water and dried well after removing fleshy portion. 1 kg pod contains 6000 seeds. Dipping seeds in Gibberellic acid 50 ppm will be effective for germination. Cold water dipping for 24 hrs will result in 30-40 per cent germination. Soil beds of size 10 x 1 m are used for sowing. Before this, soil has to be thoroughly mixed with Ekalux. 2 ½ kg seeds can be sown in each bed. Beds have to be covered with hay. Healthy seedlings are to be transferred in polythene bags. If seedlings are to be retained in the polythene bags beyond one year, host plants are necessary. Host plant will help it in its early stages of growth. Branches of the host have to be cut down (removed) frequently.

#### Natural regeneration

Natural regeneration is by bird dispersed seeds. Seedlings are naturally seen in shrubby

areas / places well surrounded by thick vegetation. This is meant for protection against sun rays, animals, drought etc. Natural propagation becomes easier if soil is wet and a host plant like Lantana is available near:

#### Planting and management

After a period of 8-10 months, seedlings of size of 20 cm tall, 5cm girth with 20-25 leaves with brownish stem and small branches are transferred to field. Three methods are used for field preparation. In one method, seeds are allowed to germinate by placing in small pits. This method is practiced usually in shrubby areas, where sprouting seedlings are well protected during rainy season.

In the second method, seeds are placed in large pits / soil mound along with host plants. In the third method, seeds are allowed to germinate within polythene bags and transferred to field in 50 cm x 50 cm x 50 cm pits with a spacing of 3 m between plants filled with 5kg FYM. Host plant is also planted along with each sandal seedling. This is the best method. Suitable host plants are *Pongamia pinnata* and *Casuarina equisetifolia*.

Sandal is a semi root parasite. It means that during the early stages of its development, it absorbs food from another plant (host plant). Flowering begins after 2-3 years of vegetative growth. It happens twice in a year from March to May and September to December. As these two flowering seasons coincide, both buds as well as mature pods are found on the same plant. Simultaneously, shade bearing capacity changes gradually and the tree later becomes a light dependent one. Small root suckers are seen arising from the cut portions. Sunlight will produce small cracks on the outer skin surface of the plant especially in the case of young trees. In extreme conditions, the wood may get exposed and the

plant will undergo total damage. In order to give protection from this, the surrounding vegetation has to be retained. Fertilization is done with 30-50 g N, 25-50g P<sub>2</sub>O<sub>5</sub> and 30-50g K<sub>2</sub>O in addition to 40 g FYM per plant per year depending upon the size and age of plant.

#### Plant protection

Sandal spike disease is a serious problem. This is believed to be caused by mycoplasma like organisms. In affected plants, growth of leaves gets stunted (assumes a spike like form and hence the name "spike disease") and later premature leaf fall occurs. Within 2-3 years, plant will die. A preventive measure is yet to be known. However, removal of affected plant parts or plants as a whole from the field is recommended against spike disease. Spike disease is transferred by pests like *Jassidus indicus*, *Moono albimaculata* etc. These vectors can be controlled by quinalphos 0.05 per cent. Sandal is also affected by stem borers such as *Zeuzera coffeae*, *Aristobia octo-fasiculata* etc. which can be controlled by spraying dimethoate 0.05 per cent.

#### Timber

Sapwood is whitish or yellowish white with no smell. Heartwood changes in colour from yellowish brown to reddish brown and has a good smell. Heartwood is produced only after 20 years of growth. Usually trees are uprooted instead of cutting from the ground level as oil content in roots is greater. One cubic meter wood weighs about 897-1137 kg. The "Kerala Preservation of Trees Act 1986" has put restriction on cutting this tree. Permit is needed for its collection, retention or sale. One can keep up to 3 kg of sandal for domestic purposes without licence. A sanctioned certificate of ownership from Tahsildar is to be submitted before Divisional Forest Officer by people who

have sandal tree at home. About 75 per cent of the selling price of a sandal tree goes to its owner. On the basis of quality, grade 1 kg sandal costs about Rs. 250-500/-.

#### Uses

Dark red coloured oil from seeds is used in making varnishes. It is also found to be

effective in skin diseases. Sandal wood oil from heartwood and roots is useful for the synthesis of powder, soap, perfumes and other cosmetic items. Sandal wood and oil are medicinal and also has religious importance. Sandal wood is used in making small boxes, stationery items, jewellery boxes etc.

## KAMPAKAM (*Hopea parviflora*)

In Kerala, Kampakam is also known as Thampakam, Irippu, Irumpakam etc. This round headed huge tree is found in the wet evergreen forests of Western Ghats. Full grown tree usually attains 30-37 m height and 4-4.5 m breadth at the end of 40 years. Mostly distributed in areas which are located in between sea level and 1100 m above it. Heavy rainfall and properly drained and aerated soil are necessary for its growth. Seen abundantly along river banks and hill slopes with fertile soil.

#### Artificial propagation

Artificial propagation is by seeds. Seeds can be stored in sacks up to 20 days. 1 kg will contain about 2500 seeds. Both direct sowing or by transferring nursery raised seedlings to fields are practiced. It is good to sow seeds soon after collection as they are recalcitrant. In the case of direct sowing, shady and weed free localities are preferable. Shade trees should be removed after 4-5 years of growth. Usually a distance of 3m x 3 m or 4 m x 4m are used. If nursery raised seedlings are used for planting, shady areas have to be preferred. After sowing, soil covering of thickness not more than 4 mm is given. If there is no rainfall, regular watering is essential. Germination takes place within 2-3 weeks.

#### Natural regeneration

Seen in forests by germination of wind dispersed seeds during rainy season. Only in

sunny regions, seedlings are found to grow well.

#### Planting and management

Seedlings of 14 to 16 months old plants are to be transferred to fields. Planting is done in pits of 45 cm cube with the onset of monsoon at a spacing of 4m x 4m filled with 5 kg FYM. Weeding and thinning are necessary for seedling growth. From second year onwards depending on size of plant, 50-70g N, 40-50g P<sub>2</sub>O<sub>5</sub>, 40-60g K<sub>2</sub>O along with 30 kg FYM are applied to each plant. If the area is fertile, within 40 years, timber of above 20 m height and 150 cm diameter will be obtained.

Even though Kampakam is an ever green tree, it will drop mature leaves during the months of December and April. They will produce pale yellowish flowers during January to February. Seeds attain maturity during the months of May-June. They can overcome drought as they are deep rooted. They prefer wet areas. Although they are shade tolerant during their early stages of growth later it becomes a light demander. Dense vegetation will destroy its seedlings. It is sensitive to fire and frost.

#### Plant protection

Usually the tree is affected by fungi like *Fomes lamarocnis*, *Trametes spongipellis* etc. which will cause rotting. Leaf spot by *Botryodiplodia theobrommae* is serious in



some parts. Plants are also affected by stem borers like *Xyleborus*, *Mussicus* etc. which can be controlled by quinalphos 0.05 per cent.

#### Timber

Timber is having more strength, weight and hardness than teak. One cubic meter timber weights about 945 kg. It is not easy to differen-

tiate heartwood and sapwood. Reddish brown timber possess white patches here and there.

#### Uses

As bark contains tannin, it is used in tanning industry. Termite and pest infections are rare, so it used in manufacture of furniture, railway sleeper, buildings etc.

## IRUL (*Xylia xylocarpa*)

Locally this is also known as Irumullu, Kadamaram, Iruppool, Panka, Pankali etc. These large sized trees are commonly seen in the deciduous forests. Mostly found in places located about 600 m above sea level. In the forest areas of malabar, a large number of trees having 30 m height and 2.5 m diameter can be seen. Profusely branched stem is its characteristic feature. Reddish ash bark is very rough and cracky. In dry areas stunted growth is reported. Grows well in places where annual rainfall is above 1000 mm and atmosphere is hot as well as humid. River banks and places with red soil are best suited for its growth. Lateritic soil is also found to be good for this species. Poor growth in clay soil.

#### Artificial propagation

This is effected by direct sowing or by planting stumps and seedlings from nursery or seedlings from forest. Sun dried seeds are used for sowing in the field. This method is found to be the most efficient one. Soaking the seeds in cold water overnight enhances germination. Seeds are sown on loose soil. Avoid clay soil. Weeding is necessary during seedling stage. Soaking the seeds in growth hormones like IAA 250 ppm or GA 50 ppm for 30 minutes will enhance germination to 70 per cent.

#### Natural regeneration

Large number of seedlings are naturally found growing in forests. They are fire and drought resistant.

#### Planting and management

Planting in the field is done at a spacing of 4m x 4m. Standard pits are filled with rich top soil and FYM 5 kg. In addition to FYM, from second or third year onwards, 50-70g N, 50-60 g P<sub>2</sub>O<sub>5</sub> and 50-70g K<sub>2</sub>O is also added to each plant depending on size. Growth is fast during favourable season. It attains a diameter increment of about 6 cm/year. Felling can be done after a period of 30-50 years growth.

At the end of the winter season, leaf fall will start. Soon after new sprouts and flowers will be produced. Light yellow flowers possess a good smell. Pods are of length 10-15 cm and diameter 4-5 cm and these brownish red pods have the shape of shoes. 8-10 seeds are present in one pod. 1 kg pod contains more than 3000 seeds. During the early stages of growth, shady regions are preferred. Later they become light demanding. Root suckers are abundantly produced in certain regions. It is a very good coppicer also.

### Plant protection

In fire damaged areas, xylia trees are found to be infected by fungi like *Fomes*, *Polystictus* etc. Stem borers and defoliators also cause severe damage. Growing of trees in healthy environmental conditions, preventing fire, grazing etc. is found to be more effective than using pesticides, fungicides etc.

### Timber

Reddish brown heartwood possesses white lines. Sapwood is pale coloured. Has more strength and hardness than teak. One cubic meter timber weighs about 832-944 kg. Wood is termite resistant. Sawn wood can be stored for about 10-15 years without any preservative treatment.

### Uses

Due to the presence of resin in the wood, they can resist the attack of fungi, termites etc. Hoopa timber was used in the manufacture of railway sleepers. It is also used in making pillars of huge buildings, bridges etc. It can resist damage by water. Pulp is used in paper industry. During the ancient period, the timber was used for making coal in iron furnace. Bark is having medicinal value. Powdered bark mixed with honey is a good medicine for diarrhoea, vomiting, gonorrhoea etc. Skin contains tannin also. Pod is edible. Leaves can be used as a bio fertilizer. Suitable for rearing Lac insect.

## MAHAGONY (*Swietenia macrophylla*)

It is an evergreen tree attaining a height of about 30-40 m and a diameter of about 3-4 m within a span of 30-35 years. This is an exotic species with bark peeling feature. Abundant growth occurs in places with average annual rainfall of 1500-5000 mm and in fertile laterite soil.

### Artificial propagation

Easiest method of propagation is by using seeds. Seeds are obtained by drying the collected pods. Viability lasts for only up to 7 months. Seeds are placed in small pits at a distance of 7.0 cm x 7.5 cm or 10 x 10 cm.

Germination starts within 2 weeks. Seedlings of height of 30 cm, 2 cm diameter with about 20 leaves are transferred to pits in the field. Direct sowing is found to be successful. Seedlings can also be transplanted in polythene bags. Polybagged seedlings having a height of 30 cm with 20 leaves are found to be better

planting materials in the main field.

### Natural regeneration

By the germination of fallen seeds. Removal of shade is essential for its germination.

### Planting and management

Poly bagged seedlings are the best planting materials in the main field. Planting is done in pits of 35 cm cube filled with top soil and 10 kg of FYM. Pits are taken with the onset of monsoon and planting is done during June-July. Unlike other species slightly wider spacing of 3m x 3m is given in the main field. Though the trees are evergreen in nature, leaf fall occurs during the months of February, March. Red coloured young leaves appear to develop at about the beginning of April-May months. Pod maturation occurs in a year. The tree is somewhat shade tolerant. Extreme shade is detrimental. Frost

sensitive. Can be cultivated as a mixed crop in teak plantations. Fertilization at the rate of 30-50 g N, 40-50 g P<sub>2</sub>O<sub>5</sub>, 50-70g K<sub>2</sub>O along with 20-30 kg FYM per plant depending on size is good from second year onwards.

#### Plant protection

Fungi like *Botryodiplodia theobromae* and *Coletotrichum gloeosporioides* produce leaf spot disease. This can be controlled by spraying carbendazim 0.05 per cent. The stem borer, *Hypsophylla robusta* is also found to infect the tree. Cultivating mahagony in blocks, along

with cashew tree will prevent the attack of stem borers.

#### Timber

One cubic meter of timber with annual rings weighs about 560 kg and is of light reddish in colour. The wood is durable, attractive and has high demand in the market.

#### Uses

Wood is used for making furniture and oil from seed is used in soap industry. It is one of the best materials for staining and design works.

## THEMBAVU (*Terminalia tomentosa*)

This tree is known as "Crocodile barked tree" as the thick, dark coloured, spitted bark looks like the skin of a crocodile. Very suitable for afforestation purposes in open places with clayey soil. It grows to about 36 m height and attains a diameter of about 4 m if the climate is favourable. It grows well in places located at about 800 m above sea level.

#### Artificial propagation

By direct sowing or by planting nursery raised seedlings. In the case of direct sowing, seeds are sown in lines keeping a distance of 12 cm between. Soaking the seeds in cold water for 24 h will result better germination. Weeding is necessary. Thinning is also essential for their healthy growth.

#### Planting and management

Planting is done in pits of 30 cm cube along with onset of monsoon at a distance of 5m x 5m. Plants are generally sensitive and watering and weeding are important during the initial years of establishment

of plantation. Leaf fall occurs during January-February. Young leaves appear during March and April. Bunches of white flowers are produced during the months of May-June. Pods get matured within 5-6 months. Root system grows deeply in the soil. Small suckers are seen sprouting out from the exposed roots. Best coppicer also. Though the tree can grow in almost all types of soils, laterite soil with proper drainage is best suited. It is drought sensitive and frost resistant.

#### Plant protection

Wood rot is caused by *Dacdalea flavida*, *Fomes melanoporus*, *Ganoderma lucidum* etc. *Metanestria hyrtaca*, *Denia litura* etc. cause premature leaf fall. Fungal diseases can be controlled by spraying carbendazim 0.05 per cent.

#### Timber

Heartwood is dark ash coloured with black spots and lines. Sap wood is reddish white. Though this is not good as that of teak, industrially it is very important. One cubic meter wood weights about 375-761 kg.

### Uses

Wood is used for making building, furniture, railway sleepers etc. Tassar silkworm moths eats its leaves. Bark contains tannin, hence

used in tanning industry. Gum from the tree has medicinal value. Juice from bark is a good colouring agent for cotton and silk cloths.

## VENGA (*Pterocarpus marsupium*)

Venga is one of the largest trees of deciduous forests. Highly branched (spreading) crown is its characteristic feature. Reddish gum is seen flowing through the timber. It attains a height of about 30 m and diameter of about 2 ½ m. Grown in steep hill slopes and plain areas. In Kerala, it is found in regions located about 1070 m above sea level. Even though they grow in almost all types of soil, good drainage is essential. Regions having rainfall 75-200 cm is best suited. This light dependent tree becomes frost sensitive during the later stages of growth.

### Artificial propagation

Artificial propagation is by seeds. Seeds are collected from full grown trees and soaked in cold water for about 2-3 days before sowing. Germination starts within 10-15 days. Seedlings of 10cm height are transplanted in polythene bags filled with potting mixture. Bagged seedlings are kept under partial shade in nursery. One kg of seed lot contains about 1000 seeds.

### Natural regeneration

Natural propagation is by seeds. In the seedling stage, shade is necessary. Protecting trees from animals and fire and also ploughing the soil enhances natural propagation.

### Planting and management

Site preparation includes ploughing the land and making 30 cm cube pits before the onset of monsoon. Pits are filled with red soil and 5 kg FYM. Planting is done at a spacing of 4m

x 4m along with south west monsoon. Fertilizer mixture of 60-70 g N, 50-60 g P<sub>2</sub>O<sub>5</sub>, 50-70 g K<sub>2</sub>O along with 25-30 kg FYM per plant is recommended from 2<sup>nd</sup> or 3<sup>rd</sup> year onwards. In the seedling stage shading is necessary. Lateral branches are pruned from third year onwards.

### Plant protection

The fungi, Polyporus gilvus, Ganoderma lucidum, Fomes fastuosus etc. are commonly found to infect this tree. Common fungicides can be used to prevent their attack.

### Timber

Sapwood is pale white. Yellowish brown heartwood possess dark lines. 1 m<sup>3</sup> timber weighs about 800 kg. The timber is highly durable upto or more than 20-22 years. Drying of timber in sun light, after soaking in water for about 6 weeks is effective in improving durability and also useful for removing stains.

### Uses

This tree is best suited for agroforestry and social forestry. Used as a shade tree in the tea and coffee plantations of South India. Gum-keno obtained from *Pterocarpus* is used for dyeing, printing, tanning etc. Leaves are used as cattle feed and green manure. Flowers and bark have medicinal properties also.

Timber is used for the manufacture of posts, buildings, beams, furniture, boat, agricultural instruments etc.

## CHADACHI (*Grewia tilifolia*)

Chadachi, also known as Uthi, has the timber looks like that of teak and is most commonly found in the moist deciduous forests of Kerala. Usually they attain a height of 12 m and 1.5 m diameter. But remarkable growth is seen in trees growing along the Western ghats which possess a height of 24 m and a diameter of 2 m. This grows well on soil which is best suited for teak plantations. Even though best growth occurs in full sun light, they are shade tolerant. It is also frost sensitive. Root suckers are produced abundantly. This species is also a good coppicer. Leaf fall occurs during the month of March and new leaves are produced during the month of April. Flower production is in February and seeds begin to mature during May.

### Artificial propagation

Seeds can be collected during the months of June-August and can be stored up to 4 months. Artificial propagation is possible by direct sowing or by planting stumps or nursery raised seedlings in the field. Warm water treatment of seeds are found to be good for better germination.

### Planting and management

Planting and management practices are similar to that of venga.

### Plant protection

In the case of old trees, wood rot is caused by the fungus *Ganoderma* sp. Therefore, aged trees have to be cut and removed as early as possible. Grown up trees are also affected by stem borers and defoliators, which can be controlled by spraying quinalphos 0.05 percent.

### Timber

Heart wood is reddish brown with black patches. Brown colour of sapwood deepens with age. More strong and elastic than Teak. One cubic meter timber has about 785 kg weight. Easy for felling and sawing.

### Uses

Timber is used for making furniture, vehicle parts, windows, doors etc. Skin and timber have some medicinal property. Coir is made from skin fibres. Seeds are edible. Leaves are good cattle feed. Mucilaginous extract from leaves is good for hair health.

## PUNNA (*Calophyllum ionophyllum*)

This is a medium sized evergreen tree best suited for protecting sea shores. Ash coloured or dark green leaves are its characteristic features. Grown well in sandy and alluvial soils. Mostly distributed along sea shores and also in the tropical evergreen forests. Cultivated as shade giving plants along road sides and also as ornamental one.

### Artificial propagation

Artificial propagation is by direct sowing or by planting nursery raised seedlings. Pods are collected during the month of March. One kilogram contains about 250 seeds. Hard coat is to be removed. Soaking the seeds in cold water for 12 hours or warm water for 40 minutes is recommended for enhancing

germination. Soaking in dilute sulphuric acid for 20 minutes is also found to enhance germination.

#### Planting and management

Planting is done mainly during the monsoon season. Pit planting is recommended at a spacing of 3m x 3m. It prefers a sandy loam soil. Watering is essential in summer months particularly during initial stages of development. It can be raised both as pure crop and also interplanted with banana or pepper. Two to three weeding are necessary during the initial stages of development. Fertilizers at the rate of 25-30 g N, 15-20 g P<sub>2</sub>O<sub>5</sub> and 20-25 g K<sub>2</sub>O can be applied depending up on size and age. There is regional variations in flowering seasons. In Kerala, flowers are produced during the months of March-April. Pods get matured at the time of May-June. This is a light demanding tree. Fire and wind will cause severe damage.

#### Plant protection

Rotting is caused by fungi belonging to the genus *Fomes*. Young plants are also infected by fungi like *Trichosoma* which can be controlled by spraying 1 per cent Bordeaux mixture.

#### Timber

Sapwood has pale reddish white colour. Heartwood is reddish brown with mottled dark lines. Felling and sawing are very easy. It can be kept in water for a long period of time without any damage. One cubic meter timber weighs about 655 kg.

#### Uses

Wood is used for making posts, beams, furniture etc. Used in plywood industry also. Dark green coloured oil from seeds is a good fuel and used for making soap, varnishes etc. Oil cake is a fertilizer. Saponin in the leaves is detritus to fishes.

## AGROFORESTRY SYSTEM

### Agrisilvicultural systems

Shade loving crops such as ginger perform better in the inter-spaces of tree species such as ailanthus (at four years of age, planted at a spacing of 2 m x 2 m; with 60 per cent of the light in the open).

Multipurpose tree species like ailanthus, teak, vellapine, silver oak and green manure yielding trees can be successfully interplanted in the older coconut plantation (preferably above 30 years of age), often in association

with other field crops including medicinal plants such as kacholam. Depending on the space available (between coconut palms), one or two rows of multi-purpose trees can be accommodated in the middle (spacing 1-2 m between plants). Tree management such as lopping/pollarding etc. is important to prevent any possible inter-specific competition between the multipurpose tree component and the coconut palms.

## AGRO-ECOLOGICAL ZONES OF KERALA

Agricultural productivity and agrobiodiversity of an area are largely governed by the overhead climate and qualities of land and soil. In the tropics and subtropics, where sunlight and temperatures are not limiting, it is often the precipitation and the capacity of the land and soil to retain water that control biological productivity. An agro-ecological delineation is characterised by distinct ecological responses to the macro-elements, which are reflected in the vegetation, soils and agricultural land use.

The concept of agro-ecological delineations was developed by FAO (1976, 1978) with strong emphasis on comparable agro-climatic parameters to delineate agriculturally potential areas suitable for particular crops or combination of crops so that optimum production potential is achieved. The significance of homogeneous agricultural environment, as realised in the agro-ecological unit is of particular importance in effective and sustainable land use to enhance agricultural output for meeting the increasing demand for food, fodder, fibre and other products. With the growing demand for food, fodder and fibre, there is overuse of land or faulty planning of land use that has resulted in soil health hazards such as soil degradation and deterioration of land quality.

The Planning Commission, consequent to a mid-term appraisal of the planning targets of the VII Plan (1985-1990), divided the country into 15 broad agro-climatic zones based on physiography and climate. In the scheme the entire Kerala State formed part of zone 12, West Coast Plains and Ghat region. The process emphasized development of resources and their optimum utilization in a sustainable manner within the framework of resource constraints and potentials of each

region. This implied a departure from the previous practice of planning with focus on specific crops and fertilizers, treating the state as a unit of planning. The State Agricultural Universities were advised to divide each zone/state into subzones, under the National Agricultural Research Project (NARP). Accordingly a map of 127 subzones was prepared, based primarily on rainfall, existing cropping patterns and administrative units. For Kerala State 8 subzones were delineated.

- 1) Northern zone
- 2) Southern zone
- 3) Central zone
- 4) High altitude zone
- 5) Onattukara zone
- 6) Kuttanad and Kole zone
- 7) Pokkali zone, and
- 8) Low rainfall zone

Kerala Agricultural University revised the NARP delineation of agro-ecological subzones to generate an Agro-ecological Zones Map of the state (Kerala Agricultural University, 2007). The basis of spatial delineations was variability in altitude, rainfall pattern, soil type and topography. The revision resulted in delineation of 13 agro-ecological zones for the state.

The National Bureau of Soil Survey and Land Use Planning (NBSS & LUP) generated a map of Agro-ecological Regions of the country (Sehgal et al., 1992) by integrating climate, physiography, length of growing period and soils, an improvement on the agro-climatic zone map of the Planning Commission which considered only physiography and climate for delineation of zones. The agro-ecological regions (AER) map of NBSS & LUP had 20 regions and the entire state of Kerala formed part of region 19: Western Ghats and Coastal Plains, hot humid-perhumid eco-region, with

red, laterite and alluvium-derived soils and growing period of 210+ days. The Bureau also generated an agro-ecological subregion map by subdividing the 20AER's into 60 subregions (Velayutham et al., 1999). Two subregions found a place in the scheme for Kerala, Subregion 19.2, Central and South Sahyadri: hot, moist subhumid to humid agro-ecological subregion and Subregion 19.3, Coastal Plain: hot humid to per-humid agro-ecological subregion.

It was felt by researchers and planners of the state that the delineations by Planning Commission, NBSS & LUP and KAU fell short of fully characterising the agro-ecological variability in the state. In order to address the problem and to generate an agro-ecological units map of the state, the Kerala State Planning Board commissioned a project to National Bureau of Soil Survey and Land Use Planning in 2008. The analysis of agro-ecology of Kerala State based primarily on climate, geomorphology, land use and soil variability resulted in delineation of five agro-ecological zones and twenty three agro-ecological units.

#### AGRO-ECOLOGICAL ZONES

Agro-ecological zones are broad spatial divisions with emphasis on physiographic features. The state has been divided into five agro-ecological zones (AEZ's). Figure 1 present the spatial distribution of the agro-ecological zones in the state.

##### 1. Coastal Plain

The Coastal Plain agro-ecological zone comprises the nearly level to gently sloping lands along the coast at elevation below 30 metres and lying between the sea and the midlands. It includes sandy beaches, sandy plains, coastal laterites and low lying areas such as estuaries, backwaters, submerged lands, swamps, marshes, kayal lands and broad valleys. The zone covers 5,09,246 ha (13.10 %) in the state.

##### 2. Midland Laterites

Midland Laterites agro-ecological zone comprises undulating to rolling lands interspersed with narrow valleys between the coastal plain on the west and foothills and hills on the east, extending from the southern end to the northern end of the state. The elevation ranges from 30 to 300 metres. The zone covers 10,56,385 ha (27.18 %) in the state.

##### 3. Foothills

The undulating to rolling lands and low hills between the midland laterite on the west and high hills on the eastern side constitute the Foothills agro-ecological zone. The terrain has only very narrow valleys. The elevation ranges from 300 to 600 metres. The zone covers 4,60,074 ha (11.84 %) in the state.

##### 4. High Hills

The hilly region comprising Western Ghats and plateaus extending from south to north constitute the High Hills agro-ecological unit. The Western Ghats and highland plateaus rise 600 metres above mean sea level, with a number of peaks well over 1800 metres. The Western Ghats comprise Central Sahyadri, the Nilgiris and South Sahyadri. The mountains are essentially plateau remnants of two or three altitudinal zones. Slopes of hill ranges can be as high as 80 per cent. The zone covers 15,53,225 ha (39.97 %) in the state.

##### 5. Palakkad Plain

The Palakkad Gap, resembling an inland plain with low elevation, is a prominent physical feature along the valley of the Bharathapuzha river. The gently sloping lands of Palakkad, east of Kuthiran hills, flanked on the south and north by Nelliampathy hills and Attappady hills, respectively and merging to Tamil Nadu uplands through the gap in Western Ghats constitute the agro-ecological zone, covering 1,60,006 ha (4.12 %) in the state.



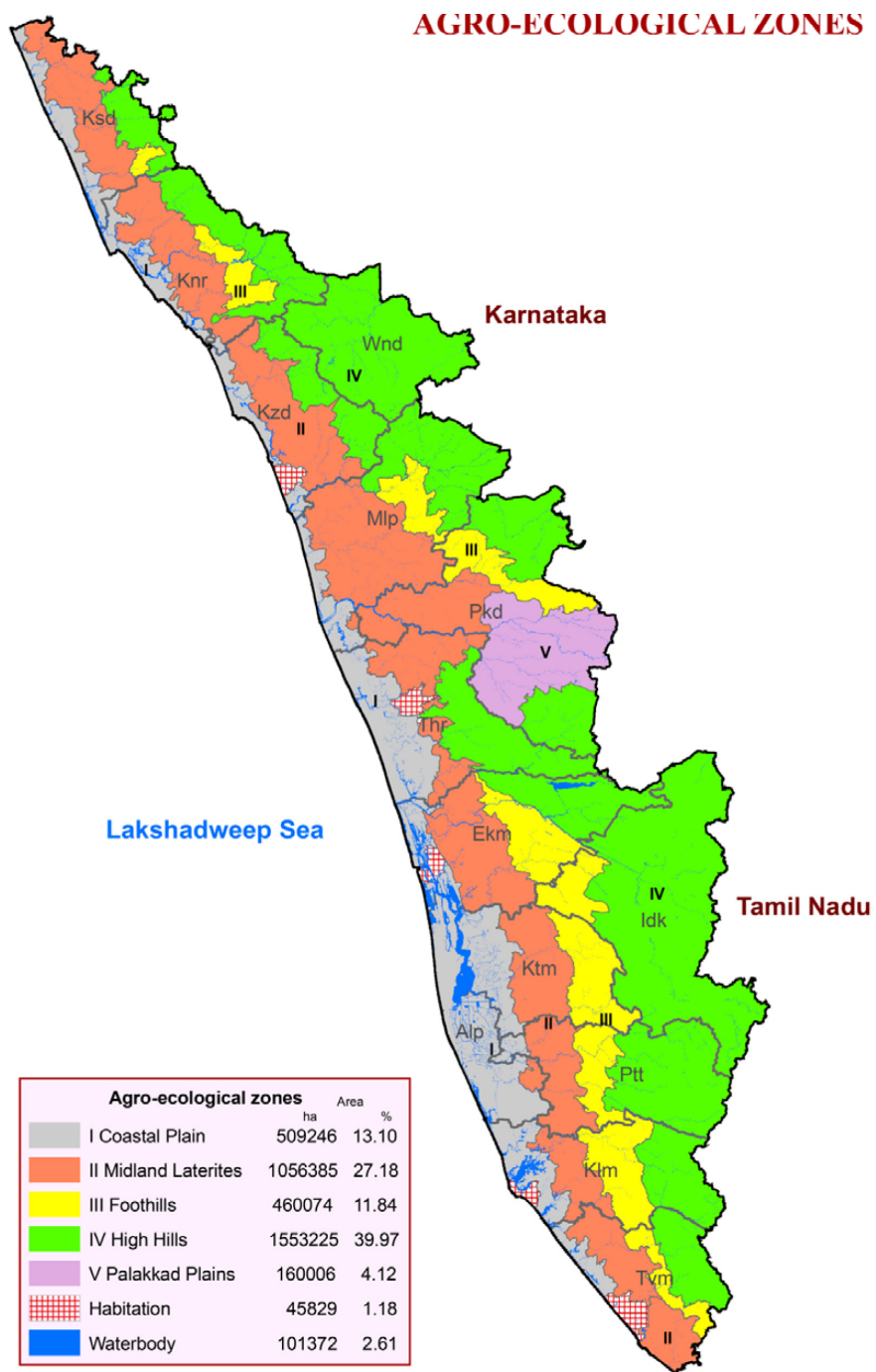

Fig. 1 Agro-ecological Zones of Kerala

## AGRO-ECOLOGICAL UNITS

Twenty three agro-ecological units (AEU's) have been delineated for the state based on climatic variability, landform and soils. Of them, five are identified for the special soil and hydrological conditions in the coastal zone requiring unique management strategies. The spatial bounding limits (external) of the agro-ecological units have been made to correspond to the administrative boundaries of panchayats. That is to say that any agro-ecological unit is a collection of panchayats. This has been done to facilitate planning of development activities on an administrative basis. Figure 2 present the spatial distribution of the agro-ecological units and Table 1 provides the area covered by the units.

### AEU 1: Southern Coastal Plain

The Southern Coastal Plain agro-ecological unit is delineated to represent the nearly level coastal lands where sands are the dominant soil type. The unit comprises 42 panchayats along the coast from Thiruvananthapuram to Ernakulam district. The climate is tropical humid monsoon type (mean annual temperature 27.6°C; rainfall 2360 mm).

Probability of annual moderate drought is one year in a block of ten years. Probability of moderate drought during NE monsoon period is twice in ten years. Probability of two consecutive weeks receiving more than 20 mm rainfall is high from mid-April to 1<sup>st</sup> week of December. Soil moisture is generally adequate for crops from mid-April to 3<sup>rd</sup> week of December. Length of growing period for annual crops is 33 weeks and dry period (duration of soil moisture deficit) 19 weeks. Coconut plantations on uplands and rice in lowlands are the major land use. The unit covers 56,782 ha (1.46%) in the state.

### AEU 2: Northern Coastal Plain

The Northern Coastal Plain agro-ecological unit represents the coastal plain north of Ernakulam district and comprises 77 panchayats along the coast from Thrissur till the northern end of the state. The unit with tropical humid monsoon climate (rainfall 3133 mm; mean annual temperature 28°C) has dominantly sandy soils on nearly level lands.

Probability of annual, moderate drought is once in ten years. Probability of moderate drought during NE monsoon period is twice in ten years. Probability of two consecutive weeks receiving more than 20 mm rain fall is generally high from 2<sup>nd</sup> week of May to 1<sup>st</sup> week of November in a year. Soil moisture is usually adequate for crops from 2<sup>nd</sup> week of May to end of November. Length of growing period for annual crops is 30 weeks and dry period (duration of soil moisture deficit), around five months. Coconut plantations on uplands and rice in lowlands are the major land use. The unit covers 1,22,970 ha (3.16 %) in the state.

### AEU 3: Onattukara Sandy Plain

The special agro-ecological unit Onattukara Sandy Plain is delineated for the sandy plains extending into the midlands from coast and covering 43 panchayats in Kollam and Alappuzha districts. Climate is tropical humid monsoon type (mean annual temperature 27.6°C; rainfall 2492 mm) and soils are sandy.

Probability of annual moderate drought is negligible. However, probability of moderate drought during NE monsoon period is twice in ten years. Probability of two consecutive weeks receiving more than 20 mm rainfall is high from April to November. Soil moisture is adequate for crops from 2<sup>nd</sup> week of April to 2<sup>nd</sup> week of December. Length of growing period of annual crops is 37 weeks and dry

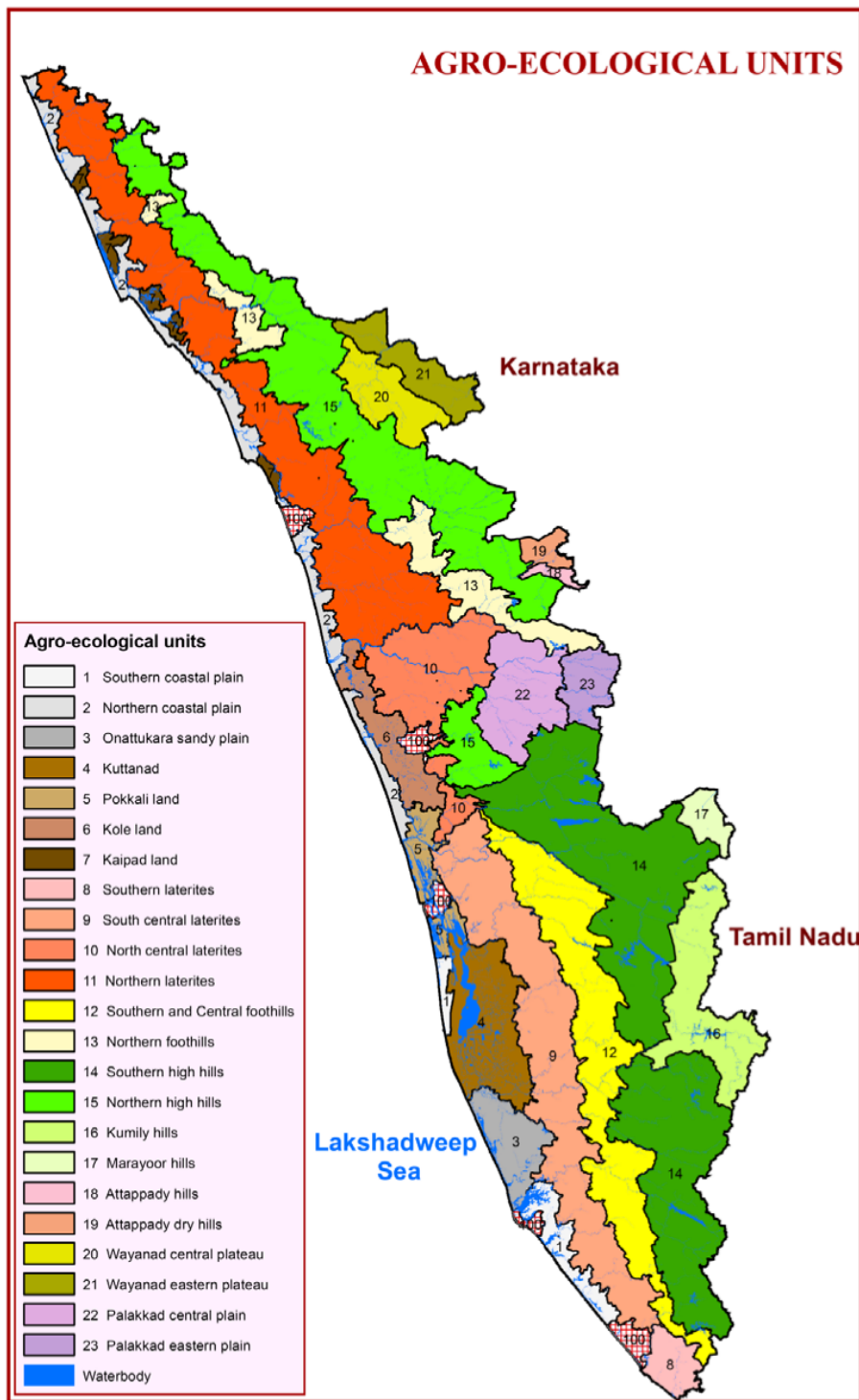

Fig. 2 Agro-ecological Units of Kerala

period (duration of soil moisture deficit), around four months. Coconut plantations on uplands and rice in lowlands are the major land use. The unit covers 67,447 ha (1.74 %) in the state.

#### AEU 4: Kuttanad

Kuttanad is a special agro-ecological unit delineated to represent the waterlogged lands spread over 69 panchayats of Alappuzha, Kottayam and Pathanamthitta districts. Large parts of these lands are below, at or just above sea level. Climate is tropical humid monsoon type (mean annual temperature 27.6°C; rainfall 2,746.1 mm).

Probability of annual moderate drought is negligible. However, probability of moderate drought during NE monsoon period is probable in one year for a block of ten years. Probability of two consecutive weeks receiving more than 20 mm rainfall is high from mid-April to end of November. In the limited areas of upland soil, moisture availability is adequate from mid-April to 3<sup>rd</sup> week of December. In the uplands length of growing period for annual crop is 34 weeks and length of dry period (duration of soil moisture deficit) is around four months.

Hydromorphic soils, often underlain by potential acid-sulphate sediments and unique hydrological conditions characterize the unit. Seawater ingress into Kuttanad is controlled through bunds and barrages to facilitate rice cultivation. Lowlands which dominate the unit, are under water the year round. Rice cultivation is made possible by dewatering (pumping out water from fields). Coconut is grown on the uplands and bunds of the unit and rice in lowlands. The unit covers 1,26,931 ha (3.27%) in the state.

#### AEU 5: Pokkali Lands

Pokkali Lands, another special agro-ecological unit, is delineated for the lowlands,

often below sea level, in coastal areas of Emakulam district and extending to parts of Thrissur and Alappuzha districts. The unit covers 34 panchayats. Climate is tropical humid monsoon type (mean annual temperature 27.6°C; rainfall 3,049 mm).

Probability of annual drought is negligible but the probability of moderate drought during NE monsoon period is twice in ten years. The probability of two consecutive weeks receiving more than 20 mm rainfall is high from 3<sup>rd</sup> week of April to 3<sup>rd</sup> week of November. Soil moisture is adequate for crops on uplands from mid-April to mid-December. Length of growing period for annual crops is 34 weeks while the length of dry period (duration of soil moisture deficit) is around four months.

Hydrology and soils are similar to those in Kuttanad. However, seawater inundation is not controlled and hence soils are acid-saline. Coconut is raised on uplands and a special kind of rice cultivation, locally known as Pokkali cultivation, is done in lowlands. The unit covers 39,765 ha (1.02%) in the state.

#### AEU 6: Kole Lands

The Kole Lands agro-ecological unit, spread over the coastal part of Thrissur district and extending to southern coastal parts of Malappuram district covers 40 panchayats. Climate is tropical humid monsoon type (mean annual temperature 27.6°C; rainfall 2,902 mm).

Probability of annual, moderate drought is once in ten years. The probability of moderate drought during NE monsoon period is twice in a block of ten years. A severe drought during NE monsoon period may occur once in a block of ten years. Probability of two consecutive weeks receiving more than 20 mm rainfall is high from 2<sup>nd</sup> week of May to 1<sup>st</sup> week of November. In the upland, soil moisture is

adequate for crops from 2<sup>nd</sup> week of May to end of November. The length of growing period for annual crops is 30 weeks while the length of dry period (duration of soil moisture deficit) is almost five months.

These lands too are, for most part, below sea level. Seawater ingress into these lands is controlled through barrages and weirs to facilitate rice cultivation. The soils are hydromorphic acid clays, often underlain by potential acid-sulphate sediments. Coconut is grown on the uplands of the unit and bunds and rice in lowlands. The unit covers 71,142 ha (1.83 %) in the state.

#### AEU 7: Kaipad Lands

The Kaipad Lands agro-ecological unit occurs along the coast of Kozhikkode, Kannur and Kasaragod districts as isolated stretches of waterlogged lands. The unit covers only 16 panchayats. Climate is tropical humid monsoon type (mean annual temperature 27.3°C; rainfall 3,254 mm).

Probability of annual drought is negligible. However, the probability of moderate drought during NE monsoon period is three years in a block of ten years. Probability of two consecutive weeks receiving more than 20 mm rain fall is high from mid May to 2<sup>nd</sup> week of November. In uplands soil moisture is adequate for crops from mid-May to last week of November. The length of growing period for annual crops is 27 weeks and length of dry period (duration of soil moisture deficit) is around five months.

The lowlands, often below sea level, do not have any protection against sea water inundation. The hydromorphic, acid-saline, clay soils are often underlain by potential acid-sulphate soils. Coconut is grown on the uplands of the unit and bunds and rice in lowlands. The unit covers 24,209 ha (0.62 %) in the state.

#### AEU 8: Southern Laterites

The Southern Laterites agro-ecological unit spread over 24 panchayats in south-western part of Thiruvananthapuram district is delineated to represent the uniqueness of climate and soils. The area with tropical moist subhumid monsoon climate receives low rainfall compared to the other areas of midland laterites (mean annual temperature 27.1°C; rainfall 1,884 mm). However, the well-distributed rainfall from both SW and NE monsoon restricts the dry period to just three months in a year.

Probability of moderate annual drought is once in ten years and of drought during NE monsoon period twice in ten years. Probability of two consecutive weeks receiving more than 20 mm rainfall is high from 3<sup>rd</sup> week of April to 3<sup>rd</sup> week of December. Soil moisture is generally adequate for crop production from mid-April to mid-January of the following year. The length of growing period for annual crop is almost 38 weeks and the dry period (duration of soil moisture deficit) is only for 3 months.

The soils, though acid and having low-activity lateritic clay, unlike in other parts of laterite terrain, are practically free of gravel and plinthite. Coconut on uplands intercropped to a variety of annual and other perennial crops and rice, tapioca, banana and vegetables on lowlands are the major land uses. The unit covers 38,727 ha (1.02%) in the state.

#### AEU 9: South Central Laterites

The South Central Laterites agro-ecological unit is delineated to represent midland laterite terrain with typical laterite soils and short dry period. The unit covering 161 panchayats of midlands extends from Thiruvananthapuram to Emakulam district. The climate is tropical humid monsoon type

(mean annual temperature 26.5°C; rainfall 2827 mm).

Probability of annual drought is negligible. However, moderate drought in the NE monsoon period may occur once in ten years. Probability of two consecutive weeks receiving more than 20 mm rainfall is high from 2<sup>nd</sup> week of April to end of November. Soil moisture is adequate for crops from 2<sup>nd</sup> week of April to end of December. The length of growing period for annual crop is almost 38 weeks and length of dry period (duration of soil moisture deficit) is three and half months.

Unlike the southern counterpart, the strongly acid, lateritic clay soils herein are gravelly and often underlain by plinthite. The lowlands have strongly acid, low-activity, non-gravelly clay soils with impeded drainage conditions. Mono-cropped rubber and coconut intercropped to a variety of annual and other perennial crops is the major land use on uplands and rice, tapioca, banana and vegetables on lowlands. The unit covers around 3,65,932 ha (9.42 %) in the state.

#### AEU 10: North Central Laterites

The North Central Laterites agro-ecological unit is delineated to represent midland laterite terrain with longer dry period than its southern counterpart, but less than the one in the north. The unit is spread over 62 panchayats, 3 municipalities and a corporation in Thrissur and Palakkad districts. The climate is tropical humid monsoon type (mean annual temperature 27.6°C; rainfall 2795 mm).

Probability of annual drought is negligible. Probability of moderate drought during NE monsoon period is twice in a block of ten years. Probability of two consecutive weeks receiving more than 20 mm rainfall is high from 2<sup>nd</sup> week of May to 3<sup>rd</sup> week of November. Soil moisture is adequate for crop growing from

2<sup>nd</sup> week of May to mid December. Length of growing period for annual crop is 32 weeks and length of dry period (duration of soil moisture deficit) is four and a half months.

The uplands have strongly acid, gravelly, lateritic, low-activity, clay soils, often underlain by plinthite. The lowlands have strongly acid, non-gravelly clay soils with impeded drainage. Coconut intercropped to a variety of annual and other perennial crops is the major land use on uplands and rice, tapioca, banana and vegetables on lowlands. The unit covers 1,71,469 ha (4.41 %) in the state.

#### AEU 11: Northern Laterites

The Northern Laterites agro-ecological unit is delineated to represent midland laterites from Malappuram to Kasaragod districts experiencing long dry period. It is spread over 163 panchayats and 6 municipalities. The climate is tropical humid monsoon type (mean annual temperature 27.3°C; rainfall 3217 mm).

Probability of annual drought is negligible. Probability of moderate drought during NE monsoon period is once in ten years. Probability of two consecutive weeks receiving more than 20 mm rainfall is high from 2<sup>nd</sup> week of May to 2<sup>nd</sup> week of November. Soil moisture is adequate for crops from second week of May to first week of December. The length of growing period for annual crops is almost 31 weeks, while the length of dry period (duration of soil moisture deficit) is 4.5 to 6 months, increasing from south to north in the unit.

The uplands have strongly acid, gravelly, lateritic, low-activity, clay soils often underlain by plinthite. Laterite duricrusts are also frequent in the unit. Coconut intercropped to a variety of annual and other perennial crops is the major land use on uplands and rice, tapioca, banana and vegetables in lowlands.

Cashew plantations are also extensive on uplands. The unit covers around 4,60,257 ha (12.36 %) in the state.

#### AEU 12: Southern and Central Foothills

The Southern and Central Foothills agro-ecological unit is delineated to represent the undulating lands with low hills, between midland laterites and the high hills of Western Ghats. It covers 90 panchayats from Thiruvananthapuram to Thrissur districts. The climate is tropical humid monsoon type (mean annual temperature 27.5°C; rainfall 3462 mm).

Probability of annual drought is negligible. However, moderate drought may occur during NE monsoon period once in ten years. Probability of two consecutive weeks receiving more than 20 mm rainfall is high from mid-March to end of November. Soil moisture is adequate for crops from mid March to 2<sup>nd</sup> week of January in the following year. Length of growing period of annual crops is almost 41 weeks and length of dry period (duration of soil moisture deficit) 2.5 months.

The strongly acid, gravelly, lateritic, low-activity, lateritic clay soils are rich in organic matter. The narrow valleys have similar but non-gravelly soils with impeded drainage conditions. Shorter dry period, absence of plinthite layer in soil and higher soil organic matter distinguish the foothills from midland laterites. Plantations of rubber, coconut, pepper and coffee abound in the unit. The unit covers 3,15,893 ha (8.13 %) in the state.

#### AEU 13: Northern Foothills

The Northern Foothills agro-ecological unit represents foothills from Thrissur to Kasaragod and differs from its southern counterpart for longer dry period. It covers 27 panchayats of Palakkad, Malappuram, Kannur and Kasaragod districts. The climate is tropical

humid monsoon type (mean annual temperature 27.5°C; rainfall 3462 mm).

Probability of annual, moderate drought is once in ten years. There is probability of one moderate and one severe drought during NE monsoon period in a block of ten years. Probability of two consecutive weeks receiving more than 20 mm rainfall is high from May to 3<sup>rd</sup> week of November. Soil moisture is adequate for crops from last week of May to 3<sup>rd</sup> week of December. Length of growing period for annual crop is 34 weeks and length of dry period (duration of soil moisture deficit) is four months.

The strongly acid, gravelly, lateritic, low-activity, clay soils are rich in organic matter. The narrow valleys have similar, but non-gravelly, soils with impeded drainage conditions. Shorter dry period, absence of plinthite layer in soil and enhanced levels of organic matter distinguish the foothill soils from north central and northern midland laterites. Plantations of rubber, coconut, pepper and coffee are the major land use. The unit covers 1,44,181 ha (3.71 %) in the state.

#### AEU 14: Southern High Hills

The Southern High Hills agro-ecological unit extending from Thiruvananthapuram to Nelliampathy in Palakkad district has elevation more than 600 metres. Besides elevation, the steep slopes of the terrain and lower temperatures distinguish the high hills from the foothills and midlands. Thirty panchayats in Thiruvananthapuram to Palakkad district constitute this unit. The climate is tropical humid monsoon type, but lower temperatures than in coastal plain and midlands (mean annual temperature 21.6°C; rainfall 3602 mm).

Probability of annual drought is negligible. Probability of moderate drought during NE monsoon period is once in ten years.

Probability of two consecutive weeks receiving more than 20 mm rainfall is high from mid-April to 3<sup>rd</sup> week of November. Soil moisture is adequate for crop from mid-April to end of January in the following year. Length of growing period for annual crops is 41 weeks, while the length of dry period (duration of soil moisture deficit) is only two months.

The steeply sloping hilly terrain has deep, well drained, strongly acid, organic-matter-rich clay soils. While forests cover major part of the unit, plantations of rubber, coconut, pepper, tea and coffee are not uncommon. The unit covers 6,72,675 ha (17.31 %) in the state.

#### AEU 15: Northern High Hills

The Northern High Hills agro-ecological unit extending from Thrissur to Kannur is similar to its southern counterpart except for the longer dry period. The unit comprises 61 panchayats spread over the northern districts. The climate is tropical humid monsoon type (mean annual temperature 26.2°C; rainfall 3460 mm).

Probability of moderate drought during NE monsoon period is twice in ten years. Probability of two consecutive weeks receiving more than 20 mm rainfall is high from 3<sup>rd</sup> week of April to mid of November. Soil moisture is adequate for crops from 3<sup>rd</sup> week of April to 3<sup>rd</sup> week December. The length of growing period for annual crops is around 37 weeks, while the length of dry period (duration of soil moisture deficit) is nearly four months, longer than in the southern counterpart.

The hilly terrain has deep, well drained, strongly acid, organic-matter-rich, clay soils. The valleys have deep, imperfectly drained, acid clay soils. While forests cover major part of the unit, plantations of rubber, coconut, pepper and coffee are not uncommon. The unit covers 5,28,434 ha (13.60 %) in the state.

#### AEU 16: Kumily High Hills

The Kumily High Hills agro-ecological unit is delineated to represent low-rainfall parts of the High Hills zone. The unit differs from Southern High Hills not only in the lower rainfall, but also the extensive occurrence of very deep, non-gravelly clay soils. Thirteen panchayats distributed in Peerumedu and Udumbanchola taluks of Idukki district constitute this unit. The climate is tropical humid monsoon (mean annual temperature 22.5°C; rainfall 1809 mm).

There is probability of one moderate drought and one severe drought during the NW monsoon period in a block of ten years. Probability of two consecutive weeks receiving more than 20 mm rainfall is high from May to mid-November. Soil moisture is adequate for crops from 1<sup>st</sup> week of May to 1<sup>st</sup> week of February (Fig. 2). Length of growing period for annual crops is 40 weeks, while the length of dry period (duration of soil moisture deficit) is often restricted to three months.

The soils for most part are very deep, well drained, acid, non-gravelly, low-activity clay. They are rich in organic matter. The highland valleys in the unit are similar, except for impeded drainage conditions. Plantations of cardamom, tea, coffee and pepper are the major land use. Forest cover is also substantial. The unit covers around 1,50,984 ha (3.81%) in the state.

#### AEU 17: Marayur Hills

The Marayur Dry Hills agro-ecological unit is delineated to represent the low rainfall region (rain-shadow) of the high hill zone and comprises only three panchayats of Idukki district. The climate is tropical subhumid monsoon type (mean annual temperature 23.7°C; rainfall 1276 mm).

Annual moderate drought is probable once in a block of ten years. Probability of moderate



drought during NW monsoon period is thrice in ten years. Probability of two consecutive weeks receiving more than 20 mm rainfall is high from 3<sup>rd</sup> week of May to 3<sup>rd</sup> week of November. Soil moisture in normal years is adequate for most crops from mid-May to mid-February of the following year. The length of growing period for annual crops is 39 weeks, while the length of dry period (duration of soil moisture deficit) is more than three months.

The unit distinguishes itself from other AEU's of high hill zone by the lower temperatures, low rainfall and soil qualities. The fertile, deep, clay soils, rich in organic matter with favourable soil reaction (slightly acid to neutral) are well supplied with bases. Land use, besides forest, comprises temperate fruits, potato, sugarcane, temperate vegetables and rice. The unit covers 28,968 ha (0.75 %) in the state.

#### AEU 18: Attappady Hills

The agro-ecological unit Attappaddy Hills, spatially distributed as a narrow strip of land along the valley in central part of the hills in North Palakkad, represents land areas of comparatively low rainfall. It comprises parts of Sholayur and Agali panchayats. The climate is subhumid tropical monsoon type (mean annual temperature 24.3°C; rainfall 1482 mm).

Probability of moderate annual drought is once in ten years. One year of moderate annual drought and one severe drought during NW monsoon period is probable in ten years. Probability of two consecutive weeks receiving more than 20 mm rainfall is high from 3<sup>rd</sup> week of June to 3<sup>rd</sup> week of November. Soil moisture is adequate for cultivated crops from mid May to 1<sup>st</sup> week of February of the following year. The length of growing period for annual crop is 39 weeks, while the length of dry period (duration of soil moisture deficit) is four months.

Besides the climate, the other distinguishing feature of the unit is the fertile, near neutral to slightly alkaline clay soils rich in organic matter and bases. Land use is mainly coconut plantations, banana, vegetables, maize and rice. The unit covers 8,872 ha (0.23 %) in the state.

#### AEU 19: Attappady Dry Hills

The Attappady Dry Hills agro-ecological unit represents land areas of very low rainfall and dry period around eight months in a year. This unit in the north-eastern corner of Palakkad district comprises parts of Puthur, Agali and Sholayur panchayats. The climate is tropical dry subhumid to semi-arid type (mean annual temperature 24.7°C; rainfall 856 mm). Much of the rainfall is received from the NE monsoon.

Probability of moderate drought during NE monsoon period is twice in ten years. Probability of a week being wet from 3<sup>rd</sup> week of September to end of December is high. Soil moisture is adequate only from 4<sup>th</sup> week of September to 2<sup>nd</sup> week of January of the following year. The length of growing period for annual crop is limited only to 15 weeks while the length of dry period (duration of soil moisture deficit) is more than eight and half months.

The hilly terrain has shallow, slightly acid or neutral, stony and gravelly clay soils. Thomy shrubs with occasional trees are the dominant land cover. Cultivation is confined to limited areas of valley lands and around tribal hamlets. The unit covers 18,495 ha (0.48 %) in the state.

#### AEU 20: Wayanad Central Plateau

The Wayanad Central Plateau agro-ecological unit represents highland plateau with low temperature and high rainfall. The unit covers 11 panchayats in Wayanad district.

Climate is tropical humid monsoon type (mean annual temperature 22.6°C; rainfall 2659 mm).

The probability of moderate annual drought is once in ten years. Probability of moderate drought during NE monsoon period, however, is twice in ten years. In addition, a year of severe drought may occur during NE monsoon period in a block of ten years. Probability of two consecutive weeks receiving more than 20 mm rainfall is high from mid-April to 1<sup>st</sup> week of November. Soil moisture is adequate from mid-April to 3<sup>rd</sup> week of January of the ensuing year. The length of growing period for annual crops extends to 39 weeks, while the length of dry period (duration of soil moisture deficit) is restricted to three months.

Upland soils are deep, acid clays and are fairly rich in organic matter. Valley soils are similar, but suffer from impeded drainage conditions. Plantations of coffee, tea, coconut, arecanut and pepper are the dominant land use on uplands and rice and banana in lowlands. Forests cover a significant area. The unit covers 74,471 ha (1.92 %) in the state.

#### AEU 21: Wayanad Eastern Plateau

The Wayanad Eastern Plateau agro-ecological unit represents parts of the high land plateau with lower rainfall. The unit comprises 6 panchayats, one in Mananthavady taluk and rest in Sulthan Bathery taluk of Wayanad district. The climate is tropical subhumid to humid monsoon type (mean annual temperature 22.6°C; rainfall 1394 mm).

Probability of moderate drought during NE monsoon period is thrice in ten years. Probability of two consecutive weeks receiving more than 20 mm rainfall is high from May to end of October. Soil moisture is adequate for most crops from May to mid-January of the next year in a normal year. The length of growing period for annual crops is almost

39 weeks and length of dry period (duration of soil moisture deficit) 4 months.

The unit differs from Central Plateau in having lower rainfall and longer dry period. Besides, the soils in this part have favourable soil reaction (slightly acid to neutral) and are well supplied with bases. Plantations of coffee, tea, coconut, arecanut and pepper are the dominant land use on uplands and rice and banana in lowlands. Forests cover a significant area. The unit covers 70,325 ha (1.81 %) in the state.

#### AEU 22: Palakkad Central Plain

The Palakkad Central Plain agro-ecological unit is delineated to represent the land areas of moderate rainfall and dry period around five months in the Palakkad plain. It is transitional to the drier eastern plain and humid western parts (AEU 10). The unit comprises 37 panchayats spread over Alathur, Chittur and Palakkad taluks and the Palakkad Municipality. The climate is tropical subhumid to humid monsoon type (mean annual temperature 27.6°C; rainfall 1966 mm).

One moderate annual drought may occur in a block of ten years. Probability of moderate drought during NE monsoon period is once in ten years. Again, severe drought in one year out of ten a might occur during NE monsoon period. Probability of two consecutive weeks receiving more than 20 mm rainfall is high from mid-May to mid-October.

Soil moisture is adequate for most crops from 2<sup>nd</sup> week of May to mid-December. The length of growing period for annual crops is 31 weeks and length of dry period (duration of soil moisture deficit) is 5 months. There is a high probability of soil moisture deficit for almost four weeks during the month of September.

The deep, well drained upland soils are non-gravelly loams and clays. Soil reaction is slightly acid or neutral and the soils are well supplied with bases. The valley soils are similar, but with impeded drainage conditions. Coconut intercropped to a variety of annual and perennial crops is the major land use on uplands and rice in lowlands. The unit covers 1,12,957 ha (2.91 %) in the state.

#### AEU 23: Palakkad Eastern Plains

The Palakkad Eastern Plain agro-ecological unit is delineated to represent the drier parts of Palakkad plain in the gap region of Western Ghats, having low rainfall, long dry period and fertile soils. The unit comprises 11 panchayats in eastern Palakkad. The climate is tropical dry subhumid monsoon type (mean annual temperature 27.6°C; rainfall 1340 mm) and dry period around six months.

Probability of moderate annual drought is thrice in ten years. The same probability holds for moderate drought during NE monsoon period as well. In addition, severe drought

during NE monsoon period might also occur for two years in a block of ten years. Probability of two consecutive weeks receiving more than 20 mm rainfall is high from 2<sup>nd</sup> week of June to 2<sup>nd</sup> week of November. Soil moisture is adequate for crops from 1<sup>st</sup> week of June to 3<sup>rd</sup> week of December (Fig. 2). The length of growing period for annual crop is almost 29 weeks while the length of dry period (duration of soil moisture deficit) extends to almost five and half months. There is a high degree of probability of soil moisture deficit from 34<sup>th</sup> to 40<sup>th</sup> std. weeks (mid-August to first week of October).

The uplands of the unit have slightly acid or neutral red clay soils well supplied with bases and plant nutrients. Lower parts of the uplands and lowlands have alkaline, swell-shrink clay soils. The fertile soils are rich in bases and plant nutrients. Lowlands have impeded drainage. Coconut, arecanut and mango are the major plantation crops. Annual crops include rice, groundnut, cotton, banana, maize, jowar and sugarcane. The unit covers 47,049 ha (1.21 %) in the state.

#### REFERENCES

- FAO (1976) A Framework for Land Evaluation. Soils Bulletin 32. Food and Agriculture Organisation, Rome, 17-32 pp.
- FAO (1978) Report on the Agro-ecological Zones Project. Vol I. Methodology and Results for Africa. Food and Agriculture Organisation, Rome, 15 pp.
- Kerala Agricultural University (2007). Package of Practices Recommendations: Crops, 13<sup>th</sup> Edition, Kerala Agricultural University, Thrissur, p. 334
- Sehgal, J., Mandal D.K., Mandal, C. and Vadivelu, S. (1992). Agro-ecological Regions of India, 2<sup>nd</sup> Edition, Tech. Bull., Publ. 24, p. 130, NBSS & LUP, Nagpur, India
- Velayutham, M., Mandal, D.K., Mandal, C. and Sehgal, J. (1999) Agro-ecological Subregions of India for Planning and Development. NBSS Publ. 35, 372 p. NBSS & LUP, Nagpur, India.

## COMPOSTING

### VERMICOMPOST AND COIRPITH COMPOST

Composting is a biological process in which microorganisms decompose organic matter and lower the carbon-nitrogen ratio of the substrate. It is generally prepared from organic waste material such as crop residue, household waste etc.

#### Methods of composting

The available residues in the farm are collected and stored till they form sufficient mass for compost making. A trench of suitable size, say, 4-6 m long, 2-3 m broad and 1-1.5 m deep is dug, the accumulated residues is well mixed and spread in a layer of 30 cm in thickness, along the length of the trench. This layer is well moistened by sprinkling cowdung slurry and water over it. A second layer of identical thickness of the mixed residues is then spread over the first layer. The process is repeated till the heap rises to a height of 45 cm to 60 cm above ground level. The top is then covered with a thin layer of soil. After three months of decomposition, the mass is taken out of the trench and formed into a conical heap above the ground, moistened with water if necessary and covered with soil. After one or two months, the manure will be ready for application in the field.

#### Vermicompost

Vermitechnology is a process by which all types of biodegradable wastes such as farm wastes, kitchen wastes, market wastes, biowastes of agro-based industries, livestock wastes etc. are converted to nutrient rich vermicompost by using earthworms as biological agents. Vermicompost contains major and minor nutrients in plant available

forms as well as enzymes, vitamins and plant growth hormones.

Species suitable: *Eudrillus eugineae* has been identified as the most ideal species of earthworm for vermitechnology under Kerala conditions.

#### Vermicomposting of farm wastes

Pits of size 2.5 m length, 1 m breadth and 0.3 m depth are taken in thatched sheds with sides left open. The bottom and sides of the pit are made hard by compacting with a wooden mallet. At the bottom of the pit, a layer of coconut husk is spread with the concave side up to ensure drainage of excess water and also for proper aeration. The husk is moistened and above this, biowaste mixed with cowdung in the ratio of 8:1 is spread up to a height of 30 cm above the ground level and water is sprinkled daily. After the partial decomposition of wastes for 7 to 10 days, the worms are introduced @ 500 to 1000 numbers per pit. The pit is covered with coconut fronds. Moisture is maintained at 40 to 50 per cent. After around 60 to 75 days, when the compost is ready, it is removed from the pit along with the worms and heaped in shade. The worms will move to bottom of the heap. After one or two days the compost from the top of the heap is removed. The undecomposed residues and worms are returned to the pit for further composting as described above. The vermicompost produced has an average nutrient status of 1.5 per cent N, 0.4 per cent P<sub>2</sub>O<sub>5</sub> and 1.8 per cent K<sub>2</sub>O with pH ranging from 7.0 to 8.0. The nutrient level will vary with the type of material used for composting.

### Precautions

1. The composting area should be provided with sufficient shade to protect it from direct sunlight.
2. Adequate moisture level should be maintained by sprinkling water whenever necessary.
3. Preventive measures should be adopted to ward off predatory birds, ants, rats, etc.

### Vermicomposting of coconut leaves

Weathered coconut leaves can be converted into good quality vermicompost in a period of three months with the help of earthworm, *Eudrillus* sp. On an average, 6-8 tonnes of leaves will yield 4-5 tonnes of vermicompost with about 1.2, 0.1 and 0.5 per cent N, P<sub>2</sub>O<sub>5</sub> and K<sub>2</sub>O respectively.

### Vermicomposting of household wastes

A wooden box of 45 cm x 30 cm x 45 cm or an earthen/plastic container with broad base and drainage holes may be selected. A plastic sheet with small holes may be placed at the bottom of the box / container. A layer of soil of 3 cm depth and a layer of coconut fibre of 5 cm depth may be added above it for draining of excess moisture. A thin layer of compost and worms may be added above it. About 250 worms are sufficient for the box. Vegetable wastes of each day can be spread in layer over the coconut husk fibre. Top of the box may be covered with a piece of sac to provide dim light inside the box. When the box is full, it can be kept without disturbance for a week. When the compost is ready, the box can be kept outside for 2-3 hours so that the worms come down to the lower fibre layer. Compost from the top, may be removed, dried and sieved. The vermicompost produced has an average nutrient status of 1.8 per cent N, 1.9 per cent P<sub>2</sub>O<sub>5</sub> and 1.6 per cent K<sub>2</sub>O, but composition will vary with the substrate used.

### Mass multiplication of earthworms

Earthworms can be multiplied in 1:1 mixture of cowdung and decaying leaves in a cement tank or wooden box or plastic bucket with proper drainage facilities. The nucleus culture of earthworms is to be introduced into the above mixture at the rate of 50 numbers per 10 kg of organic wastes and properly mulched with dried grass, straw or wet gunny bag. The unit should be kept in shade. Sufficient moisture level should be maintained by occasional sprinkling of water. Within 1-2 months, the earthworms multiply 300 times, which can be used for largescale vermicomposting.

### Preparation of vermiwash

#### Method 1

The system consists of a plastic basin having a capacity of 20 litres, a plastic perforated wastepaper basket and a PVC pipe of 5 cm diameter and 30 cm length. The waste paper basket is covered with a nylon net and placed at the centre of the basin upside down. A hole is made at the bottom of the waste paper basket so that a PVC pipe of 5 cm diameter can be placed into the basin through the hole in such a way that one end of it touches the basin. The PVC pipe is perforated so that the leachate from the basin seeps through the wastepaper basket and collects in the PVC pipe, which can be siphoned out by a kerosene pump. The basin outside the wastepaper basket, is lined with a layer of brick pieces at the bottom and a 2-3 cm thick layer of coconut fibre of 2-3 cm placed above it. After moistening this, 2 kg worms (about 2000) are introduced into it and 4 kg kitchen waste is spread over it. After one week, the kitchen waste turns into a black well decomposed compost. Two litres of water is sprinkled over the compost containing worms. After 24 hours, the leachate collected in the PVC pipe is removed by

siphoning. The collected leachate is called vermiwash, which is actually an extract of compost containing worms. This is used for soil application and foliar spray in different crops. Vermiwash is honey-brown in colour with a pH of 8.5 and N, P<sub>2</sub>O<sub>5</sub> and K<sub>2</sub>O content 200, 70 and 1000 ppm respectively. For large scale collection of vermiwash, a cement tank of size 80 cm x 80 cm x 80 cm with a side tap is constructed. A layer of small brick pieces or gravel is placed at the bottom of the tank. Above it a layer of fibre of 3-4 cm thickness is placed. A definite quantity of biowaste (4 kg) is added to the system along with 2 kg of earthworms. After two weeks, the entire mass of biowaste will turn to brownish black compost. It is sprinkled with 2 litres of water. Vermiwash is collected through the side tap after 24 hours. Biowaste can again be added to the system and the process repeated.

#### Method 2

This is a simple and economical technique to collect vermiwash. The system consists of an earthen pot of 10 kg capacity with a hole at the bottom, which is filled with pieces of stone up to a height of 10 cm from the bottom. A plastic net is spread over this. Then a thick layer of coir fibre along with humus containing 1500-2000 worms of *Eudrillus euginae* or *Isonia foetidae* is added to the pot. The hole situated at the bottom of the pot is fixed with a water tap through which vermiwash is collected. The kitchen waste of each day is added to the container. The composting process is allowed to continue for a week or more till brownish black mass of compost is obtained. Occasionally, two or three tablespoons of fresh cowdung slurry is poured on the humus as feed for the worms. After the formation of compost, the entire mass is soaked with two litres of water. After 24 hours, about 1.5 litre of vermiwash can be collected.

This process can be continued for one or two weeks till the brown colour of wash disappears. The less enriched compost that remains in the pot can be collected and used as fertilizer. Later, the pot can be emptied and set up again to continue the process.

The vermi wash, either alone or in combination with botanical pesticides can be used for pest management in kitchen gardens.

#### Recommendation for crops

When vermicompost is applied as organic manure instead of FYM, the quantity of in-organic fertilizers can be reduced to about half the recommended dose.

#### Coirpith composting

Coirpith, is produced in large quantities as waste material of the coir industry. Every year, approximately 2.5 lakh tonnes of coirpith accumulate in Kerala as waste. Coirpith has wide C:N ratio and its lignin rich nature does not permit natural composting process as in other agricultural wastes. Mushrooms belonging to the genus *Pleurotus* have the capacity to degrade part of the cellulose and lignin present in coirpith by production of enzymes such as, cellulases and lactases, bringing down the C:N ratio as well as lignin content.

#### Method of composting

Materials required: Coirpith 1 tonne, urea 5 kg, mushroom (*Pleurotus*) spawn 1.5 kg.

A shaded place of 5 m x 3 m dimension may be selected and levelled after removing weeds. 100 kg coirpith may be spread uniformly. Spread 300 g (one bottle or cover) of *Pleurotus* spawn on this and cover with a second layer of 100 kg coirpith. On the surface of the second layer, spread 1 kg urea uniformly. Repeat this

sandwiching process of one layer of coirpith with spawn followed by another layer of coirpith with urea upto 1m height. Sprinkle water if necessary to keep the heap moist. Allow the heap to decompose for one month.

The coirpith is converted into good manure after 30-40 days and the lignin content is reduced from 30 per cent to 40 per cent.

Another significant change is the lowering down of C: N ratio from 112:1 to 24:1.

This coirpith compost contains macro nutrients as well as micronutrients. It has the unique property of absorbing and retaining moisture to about 500-600 per cent. It improves the water infiltration rate and hydraulic conductivity of soil.

## BIOFERTILIZERS

The use of biofertilizers is important while practising integrated plant nutrient management as well as organic farming. Some of the commonly used biofertilizers in Kerala are as follows.

### 1. Rhizobium (Bradyrhizobium and Azorhizobium)

It induces better root nodulation and stem nodulation in inoculated plants and thereby brings down the requirement of nitrogen fertilizer for the cultivation of pulses, oil seeds and legume green manures. Commercially it is available as carrier based inoculum. Method of application is seed treatment.

### 2. Azotobacter

Suitable for upland crops like vegetables, tapioca, plantation and orchard crops. It is available as carrier-based inoculum. It fixes about 15-20 kg of N per ha under ideal upland conditions and thereby reduces the requirement of nitrogen fertilizers by 10-20 per cent. Methods of application are seed treatment, seedling dip and direct soil application.

### 3. Azospirillum

It is suitable for both upland and wetland conditions and is available as carrier-based

inoculum. It fixes about 20-25 kg N per ha under ideal conditions, thereby effecting a reduction of 25 per cent in the quantity of N fertilizers required. Treatment with *Azospirillum* also induces better root formation in inoculated plants. Hence this biofertilizer is also recommended for root induction in polybag raised seedlings of plantation and orchard crops as well as vegetables. The isolates of *Azospirillum brasilense* strains AZR 15 and AZR 37 from Kuttanad soils are highly effective for rice, vegetables and nursery plants.

#### Methods of application

**Seed treatment:** For treating 5-10 kg seeds, 500 g culture is required. Moisten the seeds by sprinkling water or rice-gruel water. Take 500 g culture in a plastic tray/basin, add moistened seeds, mix well and dry in shade for 30 minutes. This may be sown immediately.

**Seedling root dip (for transplanted crops):** Slurry of the culture is prepared by mixing 500 g culture with 50 ml of water and the roots are dipped in the slurry for 15-20 minutes before transplanting.

**Soil application:** Mix the culture with FYM or compost in the ratio 1:25 and apply directly in the soil.

Inoculation for paddy: Mix 2 kg of culture in 60 litres of water and soak the seeds required for 1 ha (60 kg) for 24 hours before sowing. At the time of transplanting, dip the roots of seedlings for 15-20 minutes in the culture slurry prepared by mixing 2 kg inoculum with 40 litres of water. This slurry can be used for treating seedlings required for 1 ha. Another 2 kg culture may be applied in the field along with FYM or compost.

#### 4. Blue green algae (BGA)

Mainly recommended for wetland rice cultivation. It is available as carrier-based inoculum and it fixes about 25-30 kg N per ha under ideal conditions. However, the use of this biofertilizer is not feasible in acidic soils with pH below 6.0.

#### Method of application

Broadcasting in the rice fields at the rate of 10 kg ha<sup>-1</sup> one week after transplanting.

#### 5. Azolla

It is suitable for wetland rice cultivation. The required quantity of azolla will have to be raised in the farmers field itself. Fixes about 25 to 30 kg N per ha.

#### Method of application

Apply fresh azolla at the rate of 10 t ha<sup>-1</sup> at the time of ploughing.

#### 6. Phosphate solubilising bacteria and fungi

Recommended mainly for upland crops raised in neutral and slightly alkaline soils. Available as carrier-based inoculum. Enables the efficient utilization of cheaper sources of phosphatic fertilizers such as rock phosphate by the crop plants.

Method of application: Seed treatment and direct application.

#### 7. Vesicular/Arbuscular mycorrhiza (VAM/AMF)

Vesicular arbuscular mycorrhiza (*Glomus* spp.) is mostly recommended for upland crops, especially for raising container and tissue culture plantlets and transplanted crops. It mainly improves the uptake of available P by inoculated plants. There is also an enhanced absorption of water and other nutrients such as N and K and certain micronutrients. Mycorrhiza inoculation can improve the survival and establishment of tissue culture plantlets under field conditions as well as induce better resistance against certain soil borne plant pathogens. It is commercially available as granular inoculum consisting of infected roots and soil with mycorrhizal spores. It is given as soil application.

VAM is suitable for tropical tuber crops. The inoculation can be done by placing inoculum (3-5 g/sett) beneath the sett before planting. The rate of spore load in the inoculum should be to the tune of 50 to 400 spores per 100 g soil medium.

#### Application techniques of biofertilizers

##### 1. Seed treatment

Five hundred grams of commercially available inoculum will be required for treatment of seeds for one hectare area. For this, thick slurry of the carrier-based inoculum is initially prepared by mixing 500 g of the inoculum in 1.25 litres of water. The stickiness of the biofertilizer on seed surface can be significantly improved by using 10 per cent jageny solution or 5 per cent sugar solution supplemented with 40 per cent boiled and cooled gum arabic solution or rice-gruel water. The required quantity of seed material is then gently mixed with this slurry without damaging the seed coat. The treated seeds are spread evenly over a gunny bag and dried in shade and sown



immediately in moist soil. The treated seeds should never be exposed to direct sunlight for a long period of time since the UV rays of solar radiation will reduce the population of inoculated bacteria on seed surface significantly.

## 2. Seedling treatment

This method is mainly recommended for transplanted crops. The roots of seedlings to be transplanted are dipped in water slurry of the biofertilizer (500 g in 2.5 litres of water) for 20 minutes, prior to transplanting.

## 3. Soil application

Soil application is generally recommended for all types of biofertilizers except *Rhizobium*, *Bradyrhizobium* and *Azorhizobium*. The method is to apply the biofertilizer after mixing with dried FYM, compost or vermicompost at the rate of 1:25. For crops of six-months duration, the recommended dose is 1-2 kg ha<sup>-1</sup>. This can be increased to 2-4 kg ha<sup>-1</sup> for crops of more than six months duration. For perennial crops, 10 to 25 g of the biofertilizer is to be applied in the root zone during the first year and 25 to 50 g during subsequent years. This can be done at the time of sowing, transplanting or during intercultivation.

Factors influencing the efficient use of biofertilizers in Kerala

1. Use adequate quantity of organic manure (as per the recommendation for each crop) along with biofertilizer application. This is essential to ensure better survival, growth and activity of the introduced microbial inoculum in acidic soils.
2. Liming is essential if the soil pH is below 6.0. In moderately acidic soils, the application of lime at the rate of 250 kg ha<sup>-1</sup> is recommended along with biofertilizer treatment.
3. Irrigation is essential during summer months after biofertilizer application to ensure the survival of the introduced microbial inoculum in the soil.
4. Since N biofertilizers can supplement only a part of the nitrogen requirement of the inoculated plant, low dose of nitrogen and full doses of phosphorus and potassium as per the recommendation may be applied. This is essential to ensure better plant growth and yield. Similarly, in the case of P biofertilizers, the full doses of nitrogen and potassium should be applied. However, there should be a gap of at least one week between application of biofertilizer and chemical fertilizer.
5. Use only biofertilizers, which are manufactured as per the quality parameters prescribed by the Bureau of Indian Standards. In the case of bacterial biofertilizers, the prescribed standard is that in the final product, the population of the desired bacterium should not be less than ten million per gram of the carrier material and there should not be any contamination with other microorganisms when examined at 1:100000 dilution. Further, it should have a shelf life of at least six months.
6. The commercially available biofertilizer should always be used before the expiry date marked on the culture packet.
7. Top dressing with superphosphate at the rate of 25 kg ha<sup>-1</sup> 10 days after inoculation of BGA will enhance its growth under field conditions.
8. Since the occurrence of green algae in rice field can affect the normal growth and proliferation of BGA, the population of green algae should be controlled initially by applying copper sulphate at the rate of 4 kg ha<sup>-1</sup>.

9. In moderately acidic soils of pH around 6.5, root nodulation by Rhizobium and Bradyrhizobium can be improved by pelleting with finely powdered calcium carbonate. (See recommendation under cowpea)
10. Application of  $P_2O_5$  at the rate of  $1 \text{ kg ha}^{-1}$  is recommended once in 4 days in  $P_2O_5$  deficient soils to ensure good growth of azolla. The development of a reddish purple colour in azolla is a typical symptom of  $P_2O_5$  deficiency.
11. Since a floating population of azolla can release its bound nutrients only during decay in the soil, it is essential to incorporate azolla in the soil prior to the transplanting of rice seedlings.

## GUIDELINES FOR MAXIMIZING FERTILIZER USE EFFICIENCY

Choice of a fertilizer depends on unit cost of nutrient present in it and its agronomic efficiency under a given situation. Fertilizer is a valuable input and measures should be taken to reduce its losses and to increase its uptake and utilisation by the crop. Selecting a situation-specific fertilizer and choosing the time and method of application according to crop demand would minimize losses and increase its efficiency.

### Nitrogenous fertilizers

Most crop plants recover only 25-35 per cent of the nitrogen applied as fertilizers. Losses occur by ammonia volatilisation, denitrification, immobilization to organic forms, leaching and run off. Utmost care should be bestowed in selecting the type of fertilizer as well as the timing and method of application.

### Choice of the nitrogen fertilizer

1. In submerged rice soil, ammoniacal and ammonia producing fertilizers like urea are most suitable since ammonia is the most stable form of nitrogen under such conditions.
2. For acidic upland soils, ammoniacal fertilizers are most suitable during rainy season since ammonium is adsorbed on soil particles and hence leaching losses are reduced. Adsorbed ammonium is gradually released for nitrification and thus becomes available to crops for a longer period.
3. In highly acidic upland soils, urea is preferred to ammonium sulphate as the former is less acid forming.
4. In alkaline upland soils of low rainfall regions, nitrate fertilizers are preferred to ammoniacal fertilizers or urea since ammonia may be lost by volatilization under alkaline conditions.

### Management of nitrogenous fertilizers

1. Almost all the nitrogenous fertilizers are highly amenable to losses and since most of the crops require nitrogen during the entire growth period, split application is necessary to ensure maximum utilization by crops.
2. More number of splits may be given for long duration crops as well as perennial crops.
3. Nitrogen losses from fertilizers are more in coarse textured soils with low cation exchange capacity (CEC) than in fine textured soils. Hence more number of splits is necessary to reduce loss of fertilizer nitrogen from sandy and other light soils.
4. For medium duration rice varieties, nitrogenous fertilizers should be given in three splits, as basal, at maximum tillering and at panicle initiation stage.
5. In coarse textured sandy or loamy soils, the entire dose of nitrogenous fertilizers may be applied in 3-4 splits at different stages of growth of rice crop.
6. In areas where split application of nitrogen is not feasible due to water stagnation after planting/sowing, full dose of nitrogen as basal may be given in the form of neem coated or coal tar coated urea.
7. In double cropped wetlands, 50 per cent of N requirement of the first crop may be applied in the organic form.

8. As far as possible, liming should be done one or two weeks prior to the application of ammoniacal or ammonia forming fertilizer like urea since ammonia is likely to be lost by volatilization if applied along with lime.
9. Almost 70 per cent of N in urea applied by broadcast to flooded soil is lost by volatilization, immobilization and by denitrification

Measures to reduce the loss of N from applied urea

1. Urea super granules or urea briquettes may be used in places where soil is clayey and has cation exchange capacity more than 10 cmol (+) per kg of soil.
2. Sulphur or lac coated urea is suitable where soil is liable to intermittent flooding and in situations where water management is difficult. This is more suitable for direct sown crop.
3. Urea may be mixed with moist soil and kept for 24-48 hours before application to the field. Alternatively, urea may be mixed with moist soil, made into balls of about three inch diameter and dried under shade. The balls may be placed deep into subsoil.
4. Mixing urea with one fifth its weight of neem cake (5:1) prolongs the period of nitrogen availability to the crop.
5. For submerged soils, coating urea with coal tar and kerosene (100 kg urea is mixed with 2 kg coal tar dissolved in one litre kerosene) before mixing with neem cake is preferred to simple mixing with neem cake.
6. Coating urea with neem extract (containing about 5 per cent neem triterpenes) at 1 per cent rate and shade drying for 1 to 1.5 hours before applying in direct seeded puddled lowland rice increases nitrogen use efficiency.

7. As far as possible, urea may be applied by deep placement or plough sole placement. Deep placement of prilled urea or super granules during the last ploughing followed by flooding and planting is beneficial in light soils. Urea briquettes or super granules may be placed between four hills of transplanted rice, whereas sulphur coated or lac coated urea may be broadcast on the surface.

8. Foliar spray of 5 per cent urea solution can be practised in situations where quick response to applied nitrogen is required. If power sprayers are used, the concentration may be increased to 15 per cent. Fresh urea should be used to avoid toxicity due to biuret.

#### Phosphatic fertilizers

Fertilizer phosphorus is an expensive input and its management poses serious problems due to several complexities in its behaviour in different types of soil. This often results in its poor recovery from applied fertilizers.

#### Choice of phosphatic fertilizer

1. In slightly acid, neutral or mildly alkaline soils, water soluble phosphatic fertilizers are more suitable.
2. In wetland rice soils, water soluble phosphatic fertilizers are preferable as pH of most of the submerged soils is near neutral.
3. In strongly acidic soils whose pH does not rise above 5.5 to 6.0 even on submergence, phosphatic fertilizers containing citrate soluble form of P like basic slag, dicalcium phosphate, steamed bone meal etc. are suitable.
4. For highly acidic upland soils or submerged soils whose pH will not rise

above 5.5 even on submergence, powdered rock phosphate is suitable. Soil acidity converts tricalcium phosphate in rock phosphate to plant available monocalcium form.

5. For short duration crops where quick response is required, water soluble phosphatic fertilizers are most suitable.
6. For perennial crops like rubber, oil palm, coffee, tea, cardamom etc. phosphorus in the form of rock phosphate can be applied.
7. In black soil (Chittur taluk of Palakkad District) phosphatic fertilizers containing water soluble phosphate like single superphosphate are most suitable.

#### Management of phosphatic fertilizers

1. Acid soils have to be amended with lime, dolomite or magnesium silicate and alkali soils with iron pyrite or sulphur before application of phosphatic fertilizers. This will help to reduce fixation and increase availability of P.
2. Surface application or broadcasting is preferred for shallow rooted crops whereas placement in the root zone is advantageous in deep rooted crops.
3. Rock phosphates can be used advantageously in rice, grown in acid soils during the virippu season. Powdered rock phosphate may be applied and mixed thoroughly with soil by ploughing. After two or three weeks, the field may be flooded, worked up and planted with rice. Under this situation, phosphorus in rock phosphate gets converted to iron phosphate, which on subsequent waterlogging becomes available to the rice crop.
4. When soil available P status is medium to high P application can be skipped. For low P status soil, P should be applied @ 45 kg  $P_2O_5$  ha<sup>-1</sup>.

5. K status of soil is maintained by straw incorporation. After straw incorporation, if soil analysis prior to cropping season indicates low K status, K should be applied @ 15 kg  $K_2O$  ha<sup>-1</sup>.
6. Rock phosphate can be used successfully as a phosphatic source for leguminous crop since its root system can extract phosphorous from rock phosphate.
7. In single crop wetlands where rice is grown in the virippu season, application of phosphatic fertilizers can be dispensed with for the rice crop, if the second crop (usually legume or green manure) is given phosphatic fertilizers.
8. In case of rice-legume cropping sequence in acid soils, application of rock phosphate to the pulse crop helps to skip phosphatic fertilizers in the succeeding rice crop.
9. Since phosphorus requirement of seasonal crops is confined to the early stages, phosphatic fertilizers are to be applied at the time of seeding or planting. Top dressing of phosphatic fertilizer leads to wastage of the fertilizer nutrient. Further, excessive phosphates may lead to deficiency of micronutrients such as zinc, boron etc.
10. Under adverse soil conditions and where quick result is required, spraying water-soluble phosphatic fertilizers like triple superphosphate or hot water extract of superphosphate can be resorted to.

#### Potassium fertilizers

For most crops, potassium can be supplied as muriate of potash. But in crops like tobacco and potato, muriate of potash may cause chloride injury, reducing quality of the produce. In such cases, K may be applied as potassium sulphate.

### Management of potassium fertilizers

1. In coarse textured soils and in heavy rainfall regions, potassium fertilizers should be applied in as many splits as possible, to reduce loss of potassium.
2. In fine textured soils, the entire dose of potassium fertilizers may be applied as basal.
3. In acid soils, potassium fertilizers should be applied only after lime application to prevent loss of potassium by leaching.

### Lime

Acid soils are characterised by high saturation of the exchange complex with hydrogen and aluminium. Crops grown in such soils suffer due to unavailability of most plant nutrients, especially calcium. Application of liming materials increases the availability of nutrients and alleviates Ca deficiency.

### Liming materials

Burnt lime [CaO], slaked lime [Ca(OH)<sub>2</sub>], powdered limestone [CaCO<sub>3</sub>] and dolomite [CaMg(CO<sub>3</sub>)<sub>2</sub>] are some of the materials used as sources of calcium.

### Management

1. In acidic submerged soils, flooding brings about rise in soil pH and hence response to lime is less marked.
2. Legumes are benefitted most by liming.
3. For better results, liming materials should be incorporated into the soil.
4. For seasonal crops and in situations where immediate results are required, burnt lime or slaked lime may be used. For perennial crops, powdered lime stone or dolomite is sufficient.
5. Extreme care should be taken while broadcasting burnt lime and slaked lime as they can cause scorching of leaves.
6. In case of wetland rice, drain the field prior to lime application and relood after 24 hours. Flushing the soil by sequential flooding and draining will help to wash out the displaced acid from the soil.
7. In extreme case of calcium deficiency, 1 per cent solution of calcium chloride may be applied by foliar spraying.

## BEEKEEPING (APICULTURE)

True honey bees belong to the family Apidae and genus Apis. They are social insects living in colonies. A colony consists of a queen, several thousand workers and a few hundred drones. There is division of labour and specialization in the performance of various functions. They build nests (combs) with wax secreted from the wax glands of worker bees. The bees use these cells to rear their brood and store food. Honey is stored in the upper part of the comb; beneath it are rows of pollen storage cells, worker brood cells and drone brood cells in that order. Some Apis species build single comb in open, while others build

multiple combs in dark cavities.

### Species of honeybees

There are four species of honeybees in India. They are:

Rock bee (*Apis dorsata*): They are giant bees found all over India in sub-mountainous regions up to an altitude of 2700 m. They build single comb nests with an area up to 1 m<sup>2</sup> or more. They are good honey gatherers with an average yield of 50-80 kg per colony.

Little bee (*Apis florea*): They are the smallest of the true honeybees found in plains

of India up to the altitude of 500 m. They build single vertical combs. They are poor honey yielders and yield about 200 – 900 g of honey per colony.

Indian bee (*Apis cerana indica*): They are the domesticated species, which construct multiple parallel combs with an average honey yield of 6-8 kg per colony per year.

European bee / Italian bee (*Apis mellifera*): They are also similar in habits to Indian bees and build parallel combs. They are bigger than all other honeybees except *Apis dorsata*. The average production per colony is 25 – 40 kg.

Stingless bee (*Trigona iridipennis*): In addition to the above, another species is also present in Kerala known as stingless bees. They are not truly stingless, but the sting is poorly developed. They make nests in the ground, hollows of trees, bamboo, rocks or cracks of walls. Honey and brood cells are separate in the nest. They are efficient pollinators. They yield 300-400 g of honey per year.

#### Swarming

Swarming is the natural instinct of honeybees to reproduce its colonies. By swarming, strong colonies are divided naturally. It occurs mostly when the colony population is at its peak. Some of the several reasons for swarming are sudden honey flow, sudden failure of queen to lay eggs, congestion in the colony, want of breeding space, bad ventilation etc. Dividing the colonies or keeping young queen or preventing over crowding of bees or adding new combs can prevent swarming.

#### Absconding

Absconding is the total desertion of colony from its nest due to incidence of disease / pest attack, too much interference

by human beings or robbing of honey by bees from other colonies. Proper hive management can prevent it.

#### Communication

The worker bees communicate with other bees about the exact location of nectar, pollen, water, next nesting site etc. by means of dances. Round dance is performed when the food is located within 100 m from hive and wagtail dance to communicate the location of food source when it is more than 100 m away from the hive.

#### Bee space

It is the space large enough to permit the free passage for worker bees but too small to encourage bees building a comb and too large for bees to deposit propolis in it.

#### Indian bee (*Apis cerana indica*)

This is the domesticated hive bee in Kerala. A colony consists of a queen, 20,000 to 30,000 workers and a few drones. This species has gentle temperament and responds to smoking. Lack of flora leads to absconding by bees. It also has a strong tendency for swarming. It yields 8-10 kg of honey per colony per year.

#### Bee-box

ISI Type-A box is recommended for the State of Kerala. A division board may be added to the bee box for adjusting the internal space depending on the strength of the colony. It can be procured from beekeepers. Wild feral colonies can be hived. Beekeepers in different regions use local hives made of low cost wood. The wood should not have a strong smell. Kail (*Pinus excelsa*), teak (*Tectona grandis*), toon (*Toona ciliata*) anjili (*Artocarpus hirsutus*), punna (*Calophyllum inophyllum*) etc., are some of the suitable woods. The hives should be preferably painted white on outside to protect the timber from weathering.

### Hiving wild colony

It is done during evening hours. Smoke the colony slightly, cut out the combs one by one and tie to the brood frames with plantain fibre. Arrange them in the box.

### Location of beehives

The apiary must be located in well-drained open area, preferably near orchards, with profuse source of nectar, pollen and water. Windbreaks may be provided by planting shrubs, flowering plants and also creepers like antigonon. Shade must also be provided. Ant wells are fixed around the hive stand. The colonies must be directed towards east, with slight changes in the directions of the bee box as a protection from rain and sun. Keep the colonies away from the reach of cattle, other animal, busy roads and streetlights.

### Management of colonies

Inspect the beehives at least once in a week during brood rearing/honey-flow seasons preferably during the morning hours. Bright, warm and calm days are suitable. If sunlight falls directly on the beehive spread cloth or a towel over the same. Look for freshly laid eggs to ensure that the colonies are healthy. Clean the hive in the following sequence, the roof, super/supers, brood chambers and floorboard. Observe the colonies regularly for the presence of healthy queen, brood development, storage of honey and pollen, presence of queen cells, bee strength and growth of drones. Look for the infestation by any of the following bee enemies.

**Wax moth (*Galleria mellonella*):** Remove all the larvae and silken webbings from the combs, comers and crevices of bee box.

**Wax beetles (*Platylolium* sp.):** Collect and destroy the adult beetles.

**Mites:** Clean the frame and floorboard with cotton swabs moistened with freshly made potassium permanganate solution. Repeat until

no mites are seen on the floorboard.

**Diseases:** The dead larvae due to Thai sac brood virus (TSBV) in the comb cells may be removed and destroyed.

### Management during lean season

Remove the supers and arrange the available healthy broods compactly in the brood chamber. Provide division board, if necessary. Destroy queen cells and drone cells, if noted. Provide sugar syrup (1:1) @ 200 g sugar per colony per week for Indian bees. Feed all the colonies in the apiary at the same time to avoid robbing.

### Management during honey flow season

Keep the colony in sufficient strength before honey-flow season. Congestion in the hive must be avoided and surplus honeybees are drawn to supers. Provide maximum space between the first super and the brood chamber and not above the first super. Place queen excluder sheets in between brood and super chamber to confine the queen to brood chamber. Examine the colony once in a week and frames full of honey should be removed to the sides of the super and such frames can be raised from brood to super chamber. The frames, which are three-fourth filled with honey or pollen and one-fourth with sealed brood should be taken out of brood chamber and in its place empty combs or frames with foundation is added. The frame with comb foundation should be placed next to the brood nest. The combs, which are completely sealed or two-third capped may be taken out for extraction of honey and returned to supers after honey extraction. This helps the colonies to activate the bees to collect and store more honey. Two or three such extractions are possible during a surplus flow. Extraction of uncapped honey will result in fermentation. Honey extraction, after the flow is over, should be avoided to save the bee colonies from robbing. Care should be taken to retain sufficient combs with honey in the brood chamber or reduce the lean period.



### Migratory beekeeping

The moving of bee colonies from one place to another to capture increased nectar flow of a particular flora is called migratory beekeeping. Copious flow of extra floral nectar available on rubber trees during January-April is exploited by shifting bee colonies to these plantations during this period.

Similar practice is done in cashew plantations and in other orchards too. Maintaining bee colonies in orchards will increase the yield, since pollination is more efficient in such orchards.

Shifting of colonies is done after sun set. Colonies should be prepared as follows. Extract available honey and fasten all the weak combs to frames with plantain fibres. Secure the frames to the chamber with packing. Close the bee entrance with cotton. Then secure the bee-box (floorboard, brood chamber, supers and roof) firmly with strong threads. Do not tilt or topple beehives while stacking them in the conveyance or during transit. Avoid strong jerks and shocks while transporting.

Set up the beehives as described above at the new site. Inspect the condition of combs and tighten loose threads, if any. This inspection should be done only in dim light. Next morning remove the cotton plug at bee entrance. Later provide comb foundation sheets, if necessary and provide sufficient space for storage of honey.

### Extraction of honey

Honey is extracted only from super combs using honey extractor. The sealing of cells on combs is removed with sharp knife before placing in the extractor. Extractor should be worked slowly at the beginning and at about 150 rpm at the end for about 1 to 2 minutes. Then the sides of the frames are reversed and the extractor is again worked. Extracted honey is filtered through muslin cloth. Providing a bee escape between the brood and

super on the day prior to honey extraction keeps the bees away from the super. Remove the escape soon after honey extraction.

### Processing of honey

Heat the honey to 45°C by keeping it in a water bath. Sieve it to remove wax particles, debris, dust and pollen. Again heat it to a temperature of 65°C in water bath and maintain it for 10 minutes. Then cool and filter it in 80-mesh muslin and store in glass, porcelain, earthenware, enamelware or stainless steel containers. Bulk storing can be made in mild steel containers lined with bee wax.

### Italian bee (*Apis mellifera*)

It is a native of Europe introduced to Himachal Pradesh and Punjab during 1962-64 and introduced to Kerala on a trial basis from Haryana in November 1992. It maintains a prolific queen, swarms less, has gentle temperament and is a good honey-gatherer. It is known to be resistant to TSBV. A healthy colony may contain 60,000 to 80,000 worker bees. The following modifications are to be followed in beekeeping with Italian bees.

### Bee-box

Langstroth beehive with ten frames each in brood and super chambers and a division brood chamber is recommended. The brood and super chambers are of the same size.

### Procuring bee colonies

Colonies can be obtained either by dividing existing colonies or by buying from other agencies.

### Location of beehives

Follow the practices as in Indian bees, but use a strong four-legged stand well protected from ants and other crawling insects by providing ant wells.

### Management of colonies

Apart from the management practices followed for Indian bee, the practices as

mentioned below may be followed.

Sources of pure water should be available near the apiary. Stagnant water or water in a container is not appropriate because it can spread nosema disease. Flowing water near the apiary should serve as a good source. As an alternative, water trickling from a container set on a stand and falling on a slanting wooden plank can be provided.

During the brood rearing season (growth period) from October to January, replacement of old queens by young healthy ones, uniting the weak colonies and giving supplementary feeding as and when required should be done. Colonies should be provided with enough space for brood rearing and food storage, by giving comb foundation sheets one at a time.

In areas where queen mating is a problem, especially when only a few colonies are kept in isolated pockets, the colony with virgin queen is to be transferred to areas where more number of colonies are kept so as to ensure the availability of queen in sufficient numbers and afterwards returned to the former apiary.

During honey flow season (January-April), provide raised combs in the super and the number of combs to be added depends on the strength of the colony. Only ripe honey is harvested when two-third of the comb cells are capped so that honey contains less than 20 per cent moisture. Care should be taken to see that the bee colonies are not stripped of all the honey stores. Enough stores of honey should be ensured in the hive at the end of honey flow for use during the following lean period. For migratory bee keeping, follow the practices as adopted for Indian bees.

#### Extraction of honey

The sealing of comb is removed with a sharp knife and the extraction done in an extractor designed for langstroth size frames.

Extracted honey is filtered through a coarse cloth to remove the impurities.

#### Processing of honey

To be done as described under Indian bees. During the lean season (May-September), remove the super chambers, arrange the available healthy brood combs in the brood chamber and use division boards to restrict the space. Provide artificial feeding once in a week by way of 1:1 sugar syrup in water. Each colony may require syrup prepared from 500-750 g sugar a week depending on the size of the colony and availability of stored food. When there is dearth of natural source, pollen substitutes may be provided in the colony.

#### Pests and diseases

Brood mite (*Tropilaelaps clareae*): Infests the brood and the infestation is severe during the major brood rearing season (October-January). These ectoparasites feed on the haemolymph of developing broods slowly killing them. Dusting sulphur on the topbars of the frames @ 200 mg/ frame at 7-14 days interval during brood rearing season is very effective in checking the infestation.

Yellow-banded wasp (*Vespa cincta*): These predatory wasps catch the bees from both the hive entrance and inside the hives. Locating and destroying their nests by burning or insecticidal usage is an effective control measure.

Wax moth (*Galleria mellonella*): Infests weak and unattended colonies. Proper cleaning of the hives periodically and keeping the hives without cracks and crevices can avoid infestation.

Black ants: Various species of black ants intrude beehives and take away honey and pollen and kill the brood and bees, which may lead to absconding of colony. The apiary should

be kept clean and the ant nests destroyed by insecticidal applications. Ant wells should be provided for the beehive stands.

#### Red tree-ant (*Oecophyla smaragdina*)

If not protected properly, the red tree-ants can cause considerable damage to the bees and the brood. The bees that come in contact with the ground are attacked and killed by the ants and dragged to their nests by a number of ants. In the apiary, if the branch of a tree with these ants happens to come in contact with the hive, the entire colony is attacked and destroyed. Providing ant wells will keep away the ants. Care should be taken not to keep the colonies near or under the trees having ant nests.

#### Bee-eater bird (*Merops orientalis*)

These predatory birds do much harm in certain localities. They pick the bees on wings and 30-43 honeybees have been found in the stomach of a bird. Attack by these birds is mostly seen during December-January. These birds are also very useful in keeping down the insect population in a locality and hence no large-scale measures against them can be recommended. Scaring them away from apiaries is suggested.

#### Thai sac brood virus

##### Symptoms

All the larval instars are susceptible to the disease, earlier instars being more susceptible. Affected larvae appear slightly plummy compared to healthy ones when examined on taking out of the comb cells. The infected larvae seen stretched on their back in the cells with the head directed outwards and turned upwards like the prow of a boat. The dead larvae look like a sac filled with milky white fluid when lifted up and it ruptures even with the slight pressure releasing the milky fluid. The cadavers change their colour from white to pale

yellow and sunk down to the floor of the cell and dry up in 10-15 days as brownish black boat-shaped scales, which are easily removable from the cells.

The sequence of visible symptoms found in the field is:

1. Presence of unsealed cells in brood area containing diseased larvae with their head directed outwards like the prow of a boat.
2. Dead larvae are seen lying stretched out on their back on the floor of brood cells and look like a sac filled with milky white fluid when lifted up.
3. Appearance of dead larvae strewn on the floorboards, hive entrance or on the floor near the hive.
4. Mottled appearance of brood combs with uncapped cells interspersed with capped cells or cells with perforated capping.
5. Appearance of more and more dead larvae left within the cells without being ejected by the worker bees.
6. Appearance of sac like remnants of dead larvae within the cells.
7. Lack of cleaning activity within the hive.
8. Decrease in egg laying rate and irregular placement of eggs.
9. Decrease in foraging activity and presence of idling workers inside the hive.
10. Dwindling of bee population of the colony.
11. Desertion of infected hives by the bees causing total loss to the apiary.

##### Management

Being a virus disease there is no known remedy. However, the following measures may help in minimizing the possibilities of further spread: a) Keep colonies strong; b) avoid exchange of hive parts, combs etc. from infected colonies to healthy colonies; c) avoid procurement of colonies or swarms from infected areas.

## SERICULTURE

### Moriculture

Mulberry can be grown under various climatic conditions ranging from temperate to tropical. Its growth depends on many climatic conditions such as temperature, humidity, rainfall etc. A temperature range of 24-28°C, humidity range of 65-80 per cent and 600-2500 mm rainfall are ideal for optimum growth of mulberry. The soil should be deep, fertile, well drained, clay loam to loam and with good moisture holding capacity. Slightly acidic (6.2-6.8 pH) soil free from injurious salts is ideal for the growth of mulberry.

### Land preparation

The field is levelled and ploughed deeply before the onset of monsoon. FYM may be applied @ 10 t ha<sup>-1</sup> for the rainfed crop and 20 t ha<sup>-1</sup> for the irrigated crop during land preparation.

### Method of planting and spacing

(a) Pit system (rainfed crop): Spacing 75 cm x 75 cm (pit size 30 cm x 30 cm x 30 cm). (b) Row system (irrigated crop): Spacing 60 cm x 60 cm (ridges and furrows).

### Planting material

The variety K2 gives higher yield and better quality leaves. Cuttings must be prepared from shoots of proper maturity (6-8 months) and thickness with well developed buds. Cuttings of 7-10 cm length and pencil thickness with 3 or 4 active buds are ideal.

### Planting

For irrigated crop, two cuttings should be planted at each spot along the margin of the ridge.

For rainfed crop, three cuttings are to be planted per pit in a triangular manner with a distance of 15 cm, keeping only one bud exposed.

### Maintenance of the garden (1<sup>st</sup> year)

After 8 months of planting, 50 kg each of N, P<sub>2</sub>O<sub>5</sub> and K<sub>2</sub>O should be applied per ha after weeding. First harvest can be taken six months after planting by leaf picking. Second dose of 50 kg N per ha should be applied 8 weeks after the first leaf harvest. Two more crops can be taken at an interval of 3 months, by leaf picking.

### Manuring

For rainfed crop apply FYM @ 10 t ha<sup>-1</sup> as a basal dose and topdress every year at the time of annual pruning. Fertilizers are applied @ 130:65:65 kg ha<sup>-1</sup> of N:P<sub>2</sub>O<sub>5</sub>:K<sub>2</sub>O in two split doses. For irrigated crop, FYM is given @ 20 t ha<sup>-1</sup> as basal dose. Fertilizers are applied @ 300:120:120 kg ha<sup>-1</sup> of N:P<sub>2</sub>O<sub>5</sub>:K<sub>2</sub>O in five split doses.

### Pruning

For rainfed crop, bottom pruning is done in May-June. Two top clippings in August/September and December/January are also practised. Middle pruning is done in October/November. For irrigated crop, bottom pruning at 15-30 cm height in May, two top clippings in August and December and two middle pruning at 60 cm height in October and February/March are practised.

### Pests

#### Tussock caterpillars (*Euproctis fraterna*)

Larvae eat the leaves of the mulberry plant. Their incidence is frequent during March to August. Collection and destruction of egg

masses and spraying 1 per cent DDVP are effective. Waiting period is 3 days.

#### Jassids (*Empoasca flarescens*)

Greenish hoppers feed on the underside of the leaf, suck sap and cause hopper burn. Spraying 0.05 per cent dimethoate is effective. Waiting period is 10 days.

#### Thrips

These are frequent during summer season. Attack is severe in rainfed gardens. Spraying 0.02 per cent DDVP is effective. Waiting period is 3 days.

#### Mealy bugs (*Maconelliococcus hirsutus*)

It causes 'tukra disease'. The affected leaves show curling and stunted growth at the growing point.

#### Scale insect

When attack is severe, branches dry and become yellow. Spraying lime sulphur solution is effective.

#### Leaf eating caterpillar (*Diacrisia obliqua*)

Appears frequently between November and January. Collection and destruction of egg masses, deep ploughing and flood irrigation to kill the pupae and application of 0.05 per cent DDVP on the leaves can prevent the attack.

#### Root knot disease (*Meloidogyne incognita*)

Common in sandy loam type of soil under irrigated conditions. Controlled by applying neem oil cake at the rate of 400 kg per ha per year in four equal split doses.

#### Diseases

##### Powdery mildew (*Phyllactina corylea*)

It is more common during November-February. White powdery patches appear on the lower side of the leaves.

##### Leaf rust (*Ceratelicum fici*)

The attacked portion of the leaves have whitish brown pustules on both sides, are deformed and non-nutritive. Infection is more in November-February. This can be controlled by spraying carbendazim 0.05 per cent or tridemorph 0.08 per cent.

##### Leaf spot (*Cercospora moricola*)

Diseased leaves have a number of circular or irregular brownish black spots of varying size. Infection is more common in rainy season. This can be controlled by spraying 0.05 per cent of carbendazim.

#### Yield

Rainfed crop : 12000-15000 kg/ha/year  
Irrigated crop : 25000-30000 kg/ha/year

#### Silkworm rearing

##### Requirements for silkworm rearing

1. Good quality mulberry leaves
2. Rearing house of approximately 20 m<sup>2</sup> for 100 dfls (disease free layings), with good ventilation, mild temperature (24-28°C) and humidity (65-85 per cent).
3. Rearing equipments like chawki stand (one), wooden trays (10), rearing racks (5), chopping board (one) and knife, wooden/bamboo rearing trays (50), chandrika/netrika (mountage) (40), leaf chamber, feeding stands, ant wells, rocker sprayer, wet and dry bulb thermometer and materials like formaldehyde / bleaching powder, paraffin paper, cleaning nets, foam rubber strips and RKO powder are required.

##### Rearing techniques

Disinfect the rearing house and equipments two-three days before rearing to prevent silkworm disease. First, wash the rearing house and the equipments with 2 per

cent bleaching powder. Then spray the room and equipments with 5 per cent bleaching powder or 2 per cent formaldehyde. Keep the rearing houses closed for 24 hours for the fumes to get diffused.

First incubate the dfls (egg card) at a temperature of 24-26°C and RH of 75-80 per cent, one day prior to hatching (blue egg stage); cover the eggs with black paper (black boxing). Next day morning, open it and expose to diffused sunlight. As the larvae emerge out, fresh tender leaves collected from the plant are chopped into 0.5 mm x 0.5 mm size and sprinkled over the hatched larvae. After half an hour, transfer the larvae to the paraffin paper spread in the chawky trays (wooden trays) using fine brush. Provide wet foam strips around and prepare a compact bed. Give another feeding in the bed. Cover with paraffin paper and stack the trays one over the other on the stand. Upto 20 layings can be brushed in a tray of 90 cm x 60 cm.

#### Feeding schedule (for 100 laying)

Instar	Leaf position from the tip	Quantity of leaf (kg)	Larval duration (days)
1	2 <sup>nd</sup> and 3 <sup>rd</sup>	2-2.5	3-4
2	3 <sup>rd</sup> , 4 <sup>th</sup> and 5 <sup>th</sup>	6-7	2-3
3	5 <sup>th</sup> , 6 <sup>th</sup> and 7 <sup>th</sup>	25-30	3-4
4	Lower leaves	75-80	4-6
5	Still lower leaves	600-650	6-7

At the end of each instar, larvae stop feeding and cast off old skin in 18-30 hours. When the worms set for moulting, paraffin paper should be removed and spread on the bed to dry up. If there are more feeding worms, a light and thin feeding may be given. All the worms settle in 6-8 hours. During moulting, worms should not be disturbed and full ventilation should be provided. Feeding is

resumed when 90 per cent of worms have moulted. RKO powder is dusted over the worms 30 minutes before feeding. After two consecutive feedings, the larvae with the net are transferred to a new tray. Mature larvae stop feeding and prepare themselves for spinning. Its body becomes translucent, shrinks in length and constrictions appear on 4<sup>th</sup> and 5<sup>th</sup> segments. They move towards the periphery of the trays. Such worms are picked and transferred to Chandrika/Netrakae. About 1000 worms (400-450 larvae/m<sup>2</sup>) can be mounted in a mountage. Mount the entire larvae within a maximum period of 48 hours and provide sufficient ventilation during spinning. Cocoon should be harvested on the fifth and sixth day after mounting. In rainy and cold seasons, it should be delayed for one more day. The cocoons are collected from Chandrika and transported in light gunny bags to cocoon market. The cocoon should be marketed immediately after harvest, so as to avoid adult emergence. Under average conditions, 100 dfls of bivoltine will yield 40-60 kg cocoons and cross breed will yield 30-50 kg cocoons.

#### Diseases

##### Pebrine

It is the most destructive disease of silk worms and is caused by protozoa, *Nosema bombyscis*. The worms become inactive with poor appetite, the skin becomes wrinkled and moulting becomes irregular.

##### Flacherie

It is caused by bacteria and poor rearing conditions like high temperature, high humidity, poor ventilation, bad leaf quality, over feeding etc. aggravates the disease. Digestive and circulatory systems are damaged and the symptoms are loss of appetite and diarrhoea.

### Grasserie

Mostly seen in ripening larvae. Caused by Borrelina virus. Infection is induced by extreme low and high temperature. Swelling of the inter-segmental region, shining skin, rupture of body wall, oozing of body fluid and endless crawling are symptoms. Such worms do not moult and spin.

### Muscardino

The fungi *Beauveria bassiana*, *Spicaria prasina* and *Isaria farinosa* are the causal agents. The infected larvae lose appetite. Specks of oozing oily substance without any clear-cut margins appear on the skin. Body generally hardens and becomes stiff.

### Prevention and control

1. Disinfect the rearing room and equipment before rearing.
2. Use only disease free layings from authorized agencies.
3. Dip the egg cards in 2 per cent formalin solution for 20 minutes before incubation.
4. Collect undersized larvae and destroy regularly by burning or burrowing in soil.

5. Feed good quality leaves of correct stages.
6. Avoid over feeding and under feeding
7. Clean the bed every day and burn the infested litter.
8. Use RKO powder at every moulting before resumption of feeding.
9. Maintain humidity only to the desired level.

### Pests

#### Uzi-fly (*Trycholyga bombycis*)

It is a serious parasite of silkworm larvae and pupae causing heavy loss. Adult is a large fly with prominent black and grey stripes. The fly prefers later instars to the earlier ones for oviposition.

### Management

Prevent the entry of fly into the rearing room by providing wire mesh or nylon net on doors and ventilators. Burn the parasitized larvae. Apply chlorpyrifos on the ground and crevices of walls of rearing house. Other pests include ants, lizards, rats, squirrels, demestid beetles and birds.

## RODENTS AND THEIR CONTROL

Rats are important non-insect pests and can be grouped into two different groups as domestic rats and field rats.

### Domestic rats

These are found near human dwellings.

1. House rats (*Rattus rattus*): There are two subspecies; one with white belly and the other with grey belly. Tail length is more than the length of head and body. They are found in houses and eat anything that man eats. They also cause qualitative damage by deposition of faecal matter, urine and hairs. It damages

gunny bags, plastic containers, clothes, electric wires etc. House rats damage tender coconuts and cocoa pods in the fields. They also act as carriers of several human and animal diseases.

2. House mouse (*Mus musculus*): Fur is short without spines. Tail is almost naked and larger than head and body. The mouse is very active and is found in houses and gardens. It can climb up walls. It damages clothes, plastic containers and food materials.

3. Large bandicoot rat (*Bandicota indica*): This is the largest domestic rat. Fur is

coarse. Tail length is almost equal to the body length. Body weight ranges from 750 to 1000 g. It damages all tuber crops. It also damages concrete buildings by making burrows under the basement.

#### Field rats

1. Large bandicoot rat (*B. indica*): Large bandicoot rats are also seen in the field. So this can be considered both as domestic and field rat.

2. Lesser bandicoot rat (*B. bengalensis*): It is a short tailed mole rat. Tail length is only 70 per cent of the body length. Fur is short and coarse. It is seen making burrows in the paddy field bunds and also in areas where crops like tubers, vegetables, coconut and young rubber are cultivated.

3. Field mouse (*Mus booduga*): Fur is short and coarse and is mostly found in gardens and fields. Tail is slender and nearly naked. Tail length is shorter than body and head. The burrows of this species are found in the paddy fields. They are found feeding on paddy grains in the mature crop as well as on seeds sown in the nursery.

4. White rat (*Tatera indica*): More than one rat per burrow is common in this species. The eyes are large. The tail is longer than the body and is provided with a terminal tuft of long hairs. It is double coloured.

5. Long tailed tree mouse (*Vandeleuria oleracea*): The fur is soft and tail is much longer than the body. They are found in most parts of India inhabiting trees and shrubs. They damage the inflorescence of arecanut and leafy vegetables by cutting its leaves.

6. Norway rat (*Rattus norvegicus*): These rats are found in waterlogged areas. This is a

medium sized rat with tail more or less equal to the length of the head and body. These rats damage paddy crop. It cuts the plants at the base and chews the cut portion. Maximum attack is at the booting stage. The attack ceases after initiation of flowering. The damage is usually observed in patches away from the field bunds.

7. Soft furred field rat (*Millardia melitana*): These rats are found in cultivated field in pairs or small groups of 5 or 6. They are soft furred without spines. These rats cut the rice plants in the transplanted crop. The damage starts at the time of planting and continues up to harvest. The tillers are cut at the water level.

8. Bush rat (*Golunda ellioti*): These rats are seen in places near forest area. They live under bushes in nests. These rats are destructive to coffee plants. They feed on their buds and flowers. They damage paddy by cutting the plants in dryland paddy areas.

#### Integrated control of field rats

Rats cause considerable damage to agricultural practices and other human possessions in addition to acting as carriers of several human and animal diseases. Diseases like bubonic plague and weils disease (due to contamination of food by the urine of rats) are caused by rats. It is necessary that the importance of rat control be understood by all. An integrated approach to control rats involves the joint utilisation of all feasible control measures in a complementary manner to maintain the rat population at a very low level. Integrated control of field rats involves the following: (a) preventing their entry into a region or a building by putting up mechanical barriers or treating with repellents; (b) encouraging predators such as snakes, cats, dogs, mongooses etc.; (c) causing death by a variety of methods.



## Methods of control

### Environmental control

In this method of control rats are rendered to a hostile environment in which they cannot survive. The mud walls in villages may be replaced by thorny hedges thereby preventing the rats from making burrows. Good house keeping is regarded as the most economical and effective way of reducing rat population. Proper sanitation should be maintained by keeping food material inaccessible to rats in rat proof containers. The heap of garbage and sweepings in streets and towns should not be kept for a long period. Designing rat proof godowns and other buildings is another step to ensure environmental control.

### Poisoning

Three types of poisoning are usually employed to control rats.

1. Acute poisons are those that can kill rats with a single dose; eg. zinc phosphide.
2. Multiple dose or chronic poisons require repeated ingestion over several successive days; eg. anticoagulants.
3. Fumigants are gases and are usually pumped or released from pellets or tablets put in through burrow entrances.

### Zinc phosphide

It is a dark grey powder and its toxic action is due to release of phosphine gas. When it is ingested, phosphine is released causing injury to the kidneys, liver and lungs followed by death after a few hours. Zinc phosphide is used in food baits containing 2 per cent active ingredient.

Pre-baiting for 3-4 days consecutively is necessary to overcome bait shyness. For pre-baiting and baiting, the same carrier material has to be used. Crushed wheat, maize,

bajra, puffed rice, popcorn or rice mixed with a little jaggery and oil are excellent carriers. To prepare the carrier, 95 parts by weight of cereal ingredient is to be mixed with 5 parts of jaggery.

For baiting, zinc phosphide is mixed with groundnut oil and carrier in the ratio 2:2:96 by weight. At each bait station, 30-40 g of the bait mixture will have to be exposed. The stations may be selected in areas where rats are frequent, such as areas around kitchen, store and in homesteads. Expose baits in the evening and collect them in the following morning. Conduct baiting for three successive days.

### Repellents

Chemical repellents include malathion and cyclohexamide which are repellents to house rats.

### Biological control

Both field and domestic rats are subjected to attack by a range of predators, parasites and pathogens. The predators include cats, dogs, snakes, owls, mongooses etc. The practice of rearing cats in house has been found to adversely affect rat population. The utilization of microbial pathogens has not proved successful in any part of the world.

### Trapping

Trapping is the oldest method of controlling rodents. Almost any trap will catch some rats, but the response varies with different species. The rats are easily caught in cage or box, but a rat trapped in such trap will be exposed to other rats which develop trap shyness and they avoid such type of traps. The most effective rat traps are those, which can completely conceal the rats trapped in it; eg. Moncompu trap. The rat traps can be grouped into a few categories.

### Live traps (cage or box trap)

1. Automatic traps: These have counter balanced entrances. When an animal enters this type of traps, its weight makes it fall into a cage below. The counter balance on the trap door brings it back into place, leaving the rodent in the cage. These are intended to catch more than one rat; eg. wonder trap.
2. Remote triggered trap: These work by upsetting a delicate balance when the bait stick is disturbed or when the weight is put on a treadle. Common type of this is the box or cage trap that captures one rat at a setting. A box trap is a wooden or metal box open at one or both ends, having one or two doors. Some have one or both will have overhead trigger on which bait is fastened and the door is released when the rat works on the bait. Others have a treadle in the floor on which the rat steps to drop the door.
3. Glues: A form of trapping in which a sticky substance entangles the animal.
4. Pot traps: These traps are extensively used for catching rice field rats. This trap consists of a wooden plank, a mud pot of 10 inch diameter, a metal strip which carry bait and a 'Y' shaped wooden peg to which needle is tied; eg. Moncompu trap.

The trap is to be set up in rice fields, after placing the base plank above the canopy level on a specially erected platform, on poles. The rats attracted by the bait climb over to the base plank and try to snatch off the bait tied on to the metallic strip. Slight disturbance of the strip dislocates the wooden needle from the strip slot and causes the pot to fall down abruptly over the rat. The pot and the plank are tightly held and removed in that position and immersed in water after inversion for killing the trapped rat. Since the live rat does

not see the captured ones, they do not develop shyness against this type of mechanical trap.

5. Snap traps: Most of the rat traps fall within this category and are widely used for trapping rats. These kill the rat instantly by snapping shut when the rat nibbles at the bait placed in the middle of the open trap. These are variously called as "break back traps", "guillotine", "spring traps", "saw toothed traps" and "bamboo traps" depending upon the materials used in making them.
6. Kerosene tin trap: It is made by cutting the top of the tin and filling it with water up to 15 cm from the top. Chaff is floated on the water surface so that the rat cannot see water. Attractive and strong smelling bait like dry fish, fried coconut etc. is pinned on to a piece of cork or lightwood and floated on the chaff. A plank is leaned against the side to enable the rat to climb to the top. Seeing no water and eager to get the bait the rat jumps on to the chaff and gets drowned.

Success or failure of trapping is dependent up on the following factors.

- a. Placement: Traps must be placed where animals will regularly encounter them.
- b. Concealment: It is not advisable to use new shining traps against rats. To overcome trap shyness it may sometimes be necessary to cover the trap with a slight coating of paper or dry leaves that does not interfere with the trigger or action.
- c. Size and design: Traps should be neither too small nor too large for the anticipated catch.
- d. Mechanical conditions: Putting out traps that are in poor working conditions is a waste of time and effort.
- e. Number of traps: Large number of traps

relative to the expected size of the rodent population should be used.

- f. Bait used: Fresh aromatic bait that is most attractive to the largest species should be used. Food grains in the houses should be properly covered so that the rat finds only the food in the trap.

Trapping is the preferred method of control in the houses and office building, because animals that get killed can be easily removed. Traps can be used profitably to deal with poison-shy and scattered survivors of poison campaign.

Control of important species of rats

Lesser bandicoot rat: These attacking tuber crops can be easily controlled by poison baiting in rodent burrows. Firstly, locate the burrows in the field. Open the burrows to a

length of 30 to 45 cm. The rats will come and close the burrows with soil within 30 minutes. Then it can be again opened and poison bait can be inserted into the burrow.

From bait preference studies indicate that, prawn powder as the most effective bait. Dry prawn available in the market is heated and powdered. A few drops of vegetable oil are added and zinc phosphide 1-2 percent is mixed with the bait. This zinc phosphide bait can be put inside the burrow preferably on a dry leaf. No pre-baiting is necessary for these rats in the garden lands since it has no bait shyness.

Norway rat: The most effective method of control has been found to be the Moncompu trap. Firstly, fresh rat-damages in the field have to be located. The rats have a habit of visiting the same area on subsequent days. Hence the traps should be placed in such spots.

## CONTROL OF LORANTHUS

Most of the tree crops of Kerala like mango, cashew, sapota, apple, pomegranate and nutmeg are infested with parasitic weeds from Loranthaceae and Viscaceae families. The weed infestation affects the growth and vigour of the tree crops resulting in yield decline and gradual death of the trees.

- Spraying Ethrel (ethephone 39% SL) @ 25ml/l will result in complete defoliation of the parasite within 48 hours.

- In case of regrowth after 3-4 months of application, padding with 2,4-D (1gm in 20 ml soaked in sponge or oasis) kept in a few nodal points on the root, after scraping the bark of the parasite will completely eliminate the weed.

Precaution

- Indiscriminate spraying of ethrel (including aerial spraying) is not recommended.
- Use of protective clothing, goggles and hand gloves are recommended.

## BIOCONTROL OF SALVINIA (*Salvinia molesta*)

Release of *Cyrtobagous salviniae* weevils is found effective for the control of salvinia. Even one pair of weevil is sufficient for establishment in a locality. But for practical consideration 50 to 100 weevils

are recommended for release in a particular area. When collection of weevil is not possible, about one kg of infested salvinia can be used as the inoculum. Release may preferably be made whenever tender salvinia

growth is available. If the plants are very old, they may be removed mechanically to promote re-growth and then weevils are to be released. Almost 100 per cent control of the weed will be obtained in a span of 12-18 months.

The rate of natural dispersal of the weevil is rather slow and hence it is desirable that the infested weed mats are redistributed at periodic intervals. In canals used for navigation, the rate of spread of the weevil is found to be quite adequate.

## BIOCONTROL OF PAPAYA MEALY BUG USING PARASITOID

Papaya mealy bug - *Paracoccus marginatus* (Pseudococcidae): Papaya mealybugs colonise lower side of the papaya leaves along the veins and later cover the fruits. Due to the mealy bug infestation, the younger plants are killed outright.

Biological control: *Acerophagus papayae* (Encyrtidae) is a parasitoid imported from Puerto Rico. The parasitoid successfully suppressed the mealybug population in Kerala. The parasitoid is very specific and did not colonise other species of mealybugs. Release rate is 25 to 50 numbers per plant. The parasitoid is parasitizing the second instar nymphs of mealybugs. It is very active and have good host searching ability and suppress the mealybug within 3 to 4 months depending upon the size of the colony.

Mass production of the parasitoid: The parasitoid can be successfully mass produced in the laboratory on papaya mealybug colonies grown on potato sprouts and shoots. Two month old potatoes are procured, washed in water, disinfected using 5% Sodium hypochlorite solution. Make slight cut on the potato and treat in Gibberelic acid 100 ppm solution for half an hour. After air drying keep the potatoes on sand and cover with black cloth for germination. Good sprouts are produced within two weeks for mass culturing mealy bugs. The parasitoids are then released to the colonies of the mealy bug. *A. papayae* has very less pre oviposition period, sex ratio is 1:1, fecundity 50-60, Total life cycle is completed in 16-20 days.

## ECOFRIENDLY MANAGEMENT OF WATER HYACINTH (*Eichhornia crassipes*) IN WATER BODIES

Water hyacinth in water bodies can be managed by spraying 5 per cent Cashew Nut Shell liquid (CNSL) emulsion followed by spraying 40 per cent Wettable Powder formulation (WP) of *Fusarium pallidoroseum* (5 per cent). Spraying may be repeated with WP 5 per cent alone, after 2 weeks if any new sprouts develop.

Preparation of 5 per cent CNSL emulsion

To prepare 10 litres of 5 per cent CNSL emulsion, 500 ml of CNSL and 50 g bar soap

are required. Slice the bar soap and dissolve in 500 ml of water. Pour 500ml. of CNSL slowly and stir vigorously to get a good emulsion. Dilute this one litre solution by adding 9 litres of water to get 10 litres of 5 per cent CNSL emulsion.

Note:

A minimum of 30 minutes may be given between the application of CNSL and *Fusarium pallidoroseum*.

In moving water bodies fencing with rope and coconut leaf is recommended.

## BIOCONTROL AGENTS AGAINST PLANT PATHOGENS

### Arbuscular mycorrhizal Fungi (AMF)

Inoculation with AMF at the time of planting in the nursery or main field improves the growth and tolerance of crop against root pathogens, particularly *Phytophthora*, *Pythium*, *Rhizoctonia* and root nematodes of black pepper, cardamom, ginger, turmeric, cowpea, upland rice and transplanted vegetables.

### Trichoderma

Biocontrol of soil borne plant pathogens involves mass introduction of antagonistic microorganisms in the soil. *Trichoderma* spp. is a group of broad-spectrum antagonists subjected to detailed studies for their potential as biocontrol agents. They are effective against the foot rot of pepper (*T. viride*, *T. longibrachiatum*), rhizome rot of cardamom (*T. longibrachiatum*, *T. virens*) and ginger (*T. viride*). A mixture of neem cake-cowdung mixture is used as food base for *Trichoderma* spp.

Dry neem cake and cowdung are to be powdered and mixed at 1:9 ratio to get a coarse texture and then moistened by sprinkling water. Add the commercial preparation of *Trichoderma* spp. (available in polythene packets) @ 1-2 kg per 100 kg of neem cake cowdung mixture. After thoroughly mixing, cover it with a perforated polythene sheet or ordinary newspaper and keep it in shade for 4-5 days for multiplication. Again mix well and keep for three more days for further multiplication. This preparation is ready for incorporation in the soil. Cowdung alone can also be used as the food base; but, since neem cake is found to be a better substrate, a mixture of the two is found better than using cowdung alone. If cowdung alone is used, mixing has to be done at 5 days interval and it will be ready for use only on the 15<sup>th</sup> day. This *Trichoderma* incorporated neem cake-cowdung mixture can

be used in the potting mixture in nursery beds and in the field; i.e. wherever cowdung is used as a manure.

For the management of foot rot of Black pepper, *Trichoderma harzianum* is recommended by fortifying 50kg farmyard manure or neem cake with 1kg of the mother culture and incubated for 10-15 days before application in the field (@ 1kg/vine). The mother culture in liquid formulation can be incorporated with sterilized coir pith compost @ 1l/20kg and apply @ 1kg/vine as above.

Prophylactic application of *Trichoderma* is effective for the management of sheath blight of rice. *Trichoderma viride* as - Seed treatment (10 g/kg seed) + Soil application (2.5kg ha<sup>-1</sup>) one week after transplanting + Foliar spray (10g l<sup>-1</sup>) after one month is effective for the management of sheath blight of rice under upland condition. Seed treatment can be recommended for submerged rice.

### *Pseudomonas fluorescens* (Ad hoc recommendation)

*Pseudomonas fluorescens* are a group of bacteria very effective against disease incited by species of *Phytophthora*, *Pythium*, *Rhizoctonia*, *Fusarium*, *Colletotrichum*, *Ralstonia* and *Xanthomonas* in various crop plants in the nursery as well as in the main field.

Isolates of *Pseudomonas fluorescens* have been developed by the Kerala Agricultural University for the disease management and growth promotion of crop plants. This is found highly effective for the management of foot rot and fungal rot of black pepper; sheath blight and bacterial leaf blight of paddy, bacterial leaf spot and *Phytophthora* infestation in betel vine, bacterial wilt of solanaceous vegetables, bacterial leaf blight of anthurium

and *Colletotrichum* and *Phytophthora* infestation in vanilla and rhizome rot of ginger. The organism significantly improves the growth and biomass production of crop plants.

Application of *Pseudomonas fluorescens* at the rate of 10 g formulation mixed with 2 kg of well decomposed farmyard manure or compost and applied in the basin of pepper vine in the field can also help control foot rot.

#### Method of application

The time of application and the frequency of application may vary depending on the crops. The application may be repeated based on the intensity of the disease incidence.

The talc-based formulation at 1-2 per cent level may be used for soil drenching and spraying. Seedlings/cuttings are treated with *Pseudomonas* culture by dipping the root/tip of cuttings in slurry of *Pseudomonas* (250 g

in 750 ml for 20 minutes). For seed treatment in paddy the talc based culture may be added to the water used for sprouting at the rate of 10 g per kg of seed.

For transplanted crop, root dip treatment at the time of transplanting, followed by a spray 30 days after transplanting can be recommended. For black pepper, drenching the nursery plants immediately after planting followed by one or two sprays depending on the extent of disease. For managing foot rot of pepper in the main field, drenching the base of the vine and spraying the plant with *Pseudomonas* culture at the rate of 10 g/litre at the onset of monsoon can be practised. A second spray may be given, if necessary, during the mid-monsoon period.

Chemical fertilizers and plant protection chemicals should not be used along with biocontrol agents.

## SOIL SOLARIZATION

Solarization is a method of hydrothermal disinfection. This is done by covering moist soil with transparent polythene sheet and exposing it to direct sunlight during the hottest period of the year.

#### Methods of solarization

##### a. Nursery bed

The nursery bed for raising seedlings is to be levelled and pebbles present on the surface removed before solarization. Incorporate the required quantity of organic manure in the soil and irrigate at the rate of 5 litres per m<sup>2</sup>. Cover the beds with 100-150 gauge transparent polythene sheets. Seal the edges of the sheet with soil to keep it in

position in order to maintain the temperature and moisture inside the polythene mulch. Adequate care is also to be taken to see that the sheet is in close contact with the surface of soil to prevent the formation of air pockets between the soil and polythene sheet. Keep the sheet in this way for 20-30 days. Protect it from stray animals and birds. After the period of solarization, remove the sheet and the bed is ready for sowing and transplanting.

##### b. Potting mixture

The required type of potting mixture is to be prepared as per the recommended practice. Spread this mixture on a levelled ground to a height of 15-20 cm. Moisten with

water using a rose-can and cover the soil with polythene sheet and solarize for 20-30 days as described above. After solarization, the soil can be used for sowing/planting. This method is found to be very effective to raise disease free pepper cuttings.

#### c. Main field

Solarization can also be effectively used for the control of soil borne diseases in the main field. The land used for planting is initially prepared to a fine tilth and pebbles removed. Solarization and planting can then be done as already described. All the other agronomic practices are to be followed as per the package of practices recommendations. Biopesticides and fertilizers can be incorporated in soil after removing the polythene sheet.

#### Hints for solarization

1. Solarization is to be done in open field without any shade.
2. Transparent thin polythene sheet (100 to 150 guage) is to be used, as it is both cheaper and more effective in heating due to better radiation transmittance than thicker sheets.
3. Summer months are more suitable for solarization.
4. Soil should be kept moist during solarization to increase the thermal sensitivity of resting structures of soil-borne plant pathogens and weeds and to improve heat conduction.
5. Solarization period may be extended to one month or more to ensure pathogen control at deeper layers.
6. Summer showers will not affect solarization. However, excessive seepage of water into the bed during solarization should be avoided.
7. Potting mixture should never be heaped and solarized, as this will drastically reduce the efficiency of the technique.
8. Soil should be in good tilth allowing close contact between the plastic sheet and the soil to prevent the formation of airpockets, which will reduce heat conduction.

#### Benefits of solarization

1. Control of fungal pathogens: Several soil borne pathogens can be controlled by solarization. This includes fungi like *Pythium*, *Phytophthora*, *Fusarium*, *Rhizoctonia* etc.
2. Control of nematodes: Population reduction of nematodes like *Meloidogyne*, *Heterodera*, *Xiphinema*, etc. can be achieved by solarization.
3. Control of weeds: A number of commonly occurring weeds particularly annuals can be effectively controlled by solarization. These include, among monocots, *Cynodon dactylon*, *Cyperus rotundus* and *Digitaria ciliaris* and among dicots, *Crotalaria muconata*, *Indigofera hirsuta* and *Noxia* sp.
4. Plant growth response: Increased growth response is observed in plants cultivated in solarized soil. This is mainly evident as increase in plant height, number of leaves, better root formation, increased root nodulation in legumes and yield.

## MUSHROOM CULTIVATION

Species of *Pleurotus*, commonly known as oyster mushrooms, grow saprophytically under natural conditions on trees, dead wood, stumps and branches. Today several species of *Pleurotus* are commercially grown in many parts of the world. The tropical climate prevalent in the state is ideal for mushroom cultivation. Species of *Pleurotus* and *Volvariella* can be successfully cultivated in the State all round the year on a variety of agro-wastes like saw dust, vegetable and paper wastes, oil palm pericarp waste and straw. But the most suitable substrate is found to be paddy straw (Table 36).

### Variety

**Ananthan :** Short duration variety of oyster mushroom. It is an inter-stock hybrid of *Pleurotus petaloides* with firm flesh, pure white colour and is resistant to pest and diseases. It has good cooking quality as well as consumer acceptability and can be grown on wheat, paddy and sorghum straw. On an average, it takes eight days from spawning to harvest. Yield potential is 800 g per kg straw.

**Bheema :** High yielding white milky mushroom.

### Method of cultivation

Polythene bags or tubes of 30 cm x 60 cm size and 150-200 gauge thickness are taken for filling the substrate. If the tubes are used, the free-end is tied with a string. Seven to eight holes of 0.5-1.0 cm diameter are made all over the bag for aeration. One kg of well dried, one year old paddy straw is cut into small bits of 5-8 cm in length and immersed in water for 18 hours. Then the soaked straw is taken out from water and kept inside the basket for 1-2 hours to drain away excess water. The soaked straw

is kept under boiling water (100°C) for 30-40 minutes for surface sterilization or to achieve pasteurization and then taken out and kept inside the basket to drain excess water and is allowed to cool to room temperature. The pasteurized straw is ready for filling the bags. Instead of straw bits, small round straw bundles of 20 cm diameter are also used for filling the bags. This method is followed to save time and labour. Now the perforated polythene bag is filled for about 5 cm height with the above processed straw and pressed with hand for making it even. Care should be taken to fill the bags as compactly as possible for the proper growth of mycelium. For getting maximum yield, 2-2.5 per cent (125 g) of spawn is used. Spawn is taken out from packets and kept inside a clean container or paper. From this, one tablespoon full of spawn is sprinkled over the filled straw around the peripheral region. A second layer of processed straw is filled and spawned as above. Repeat the process as above until the soaked straw is finished. Every time before spawning, press the straw with hand for making it compact. If bundles are used for filling the bags care should be taken to keep the bundles inside the bag as compact as possible without leaving any space in between the bundle. Finally the bag is closed tightly with twine and beds are kept undisturbed for spawn running for about 15-20 days inside the rooms, thatched rodent-proof sheds or in verandas. The best temperature and humidity for spawn running ranges from 28-30°C and 80-85 per cent respectively. The beds can be arranged over a platform or in shelves. The spawn running can be judged from the whitish growth covering the straw completely. Periodically observe the beds and discard the contaminated ones. After 15 days when the spawn



Table 36. Salient characters of common edible species of mushrooms of Kerala

Characters	<i>Termitomyces robustus</i>	<i>Termitomyces mammiformis</i>	<i>Termitomyces microcarpus</i>	<i>Pleurotus cornucopiae</i>	<i>Pleurotus squarrosulus</i>	<i>Boletus edulis</i>
1. Pileus: Size	Large	Medium	Small	Medium	Medium	Large
Shape	Convex to planoconvex	Convex to flat	Convex	Flabelliform	Flabelliform	Gloulkar
Colour	Pale cream	Whitish grey	White to cream	White	White to cream with scales	Pale green
Texture	Not very soft	Soft	Soft	Fleshy, turns fibrous when old	Fleshy, turns fibrous when old	Fleshy
Margin	Smooth, lacerate	Entire	Lacerate	Decurved, later expanded	Decurved	Involute
2. Gills	White, free with decurrent tooth	White, free	White, free	Creamy white to lilac decurrent	White to creamy decurrent	Absent; instead, tubes are present
3. Stipe	White, solid, taper to pseudorhiza which is also solid	White, solid, pseudorhiza hollow with blunt end	White slender; tendency to form pseudorhiza	Very short, often absent	Stipitate	Tough, thick and solid
4. Annulus	Absent	Persistent	Absent	Absent	Absent	Absent
5. Spores	Pale-pink	White	Pink	Lilac	Creamy white	Olivaceous
6. Habit	Solitary or scattered	Gregarious	In groups	In clusters	In clusters	Scattered
7. Habitat	Associated with termite hills	Associated with termite hills	On soil	On wood logs and tree stems	Logs, wood stems, especially on mango tree	Mycorrhizal, associated with trees like, jack, mango etc.
Remarks	Commonly known as up-pukoon, highly delicious	Common name perumkala	Common arikoon; very widely used in Kerala	Known as marakoon	Known as marakoon	Known as pannikoon

running is complete, remove the polythene bag by cutting it with blade and keep the bed for sporocarp formation. The opened beds are kept in well-ventilated rooms. Relative humidity of the room should be 80-85 per cent. If temperature inside the room rises above 30°C, the room should be sprinkled with water to lower the temperature. Diffused light is essential for normal fruiting. Pinhead formation starts on 20<sup>th</sup> day and 2-3 days are required for the maturation of the fruiting body.

#### Cropping and yield

Matured and fully opened sporocarps are harvested by placing the thumb and forefinger

near the base of the fruiting body and twisted in clockwise direction to get it detached from the mycelium. An average yield of 500-700 g can be harvested from 1 kg of straw. This straw can be used as enriched cattle feed.

#### Management of Pests and contaminants of Oyster mushrooms in Kerala

☞ Maintain the pH of the water used to soak the substrate at 8.0 by adding lime.

☞ Cover the holes with cotton or alternatively put 30 - 40 pin pricks on the polythene cover of the mushroom bed.

☞ Spray 2 per cent garlic in and around the vicinity of mushroom beds

**E0  
04** Spot application of Carbendazim (at the rate of 50 ppm) in mould affected parts of the bed.

**E0  
04** Erect Yellow Light traps for every 25m<sup>2</sup> at a height of 60 cm from the ground in the mushroom house.

**E0  
04** Hang a yellow bulb (15W) in between two card board pieces (15 cm x 15 cm size) coated with mustard oil. Switch on the bulb from 5 pm to 8 am. Remove insects trapped on the sticky surface everyday.

#### Cultivation of paddy-straw mushroom

The paddy straw mushroom can be successfully cultivated in the plains of Kerala throughout the year where the temperature ranges between 28-32°C. The straw beds can be laid out in sheds, veranda of buildings and even under shades of trees during summer. Beds should not be kept under direct sunlight. Prepare a raised platform of 1 m long and 0.5 m broad with wooden planks or bricks. Ten to fifteen kg of well-dried and hand-threshed straw is required to raise a single standard bed. For spawning this bed, two bottles of spawn and about 100 to 150 g of red gram powder are needed. First the straw is made into twists of about 5 to 8 m long and 20-25 cm diameter. The twists are tied into small bundles and are kept immersed in clean water in tanks for about 6 to 12 hours. After this, the bundles are taken out and kept aside for some time to drain the excess water. The bundles are untied and the straightened twists are placed lengthwise over the platform in a zigzag fashion. The twists are placed as close as possible. Keep another layer over the first layer crosswise. These two layers form the first layer to be

spawned. Break open the spawn bottles and carefully divide the spawn into small bits of 2-2.5 cm thick. Place these bits of spawn all the rate of along the periphery of the bed, about 5-8 cm away from the edge and 10 cm apart. Sprinkle a teaspoon full of coarsely powdered red gram powder before and after spawning the first layer. Build the next layer with one row of twist as done before and spawn it. Make successive layers until the straw twists are finished. After placing the last of twists, press the bed thoroughly from the top in order to drain excess water. Make the bed as compact as possible and cover with a transparent polythene sheet to maintain the temperature and relative humidity within the bed. Place another wooden plank over the bed and keep 4-5 bricks above the plank to get more compactness. Keep the bed undisturbed for 6-7 days. Slowly remove the sheet and observe the moisture level of the straw. If the moisture is excess remove the sheets for half an hour and then cover it again as before. Small white round pinheads appear all along the sides of the bed after 7 days and mature into button and egg stage on 9<sup>th</sup> day. Harvest the mature sporocarps in egg stage. About 2-3 kg of mushrooms can be harvested from 10 kg of straw. Cropping lasts for 2-3 days. After the harvest, the spent straw can be sun-dried and used as cattle feed.

Instead of twists, the beds can be laid out using small bundles of straw each weighing about one kg. Place four such bundles of straw side by side over the platform with loose ends towards the same direction. Over this, place another four bundles, the loose ends towards the opposite direction. These eight bundles form one layer, which is to be spawned as in the case of twists.

## TISSUE CULTURE PROPAGATION OF CROPS

Plant tissue culture is the *in vitro* culture of plant cells, tissues and organs under aseptic condition in defined or semi-defined media. Tissue culture techniques are increasingly being used for the rapid vegetative propagation of plants. It helps in the mass clonal propagation of crop plants. It is useful for plants which do not set seeds or where the viability of the seeds is poor. Even when conventional methods of vegetative propagation are commercially acceptable, tissue culture propagation can be adopted as it has definite advantages. It offers an extremely rapid rate of multiplication. The geometric progression of tissue culture propagation makes it possible to produce millions of plants from an initial explant in a few months. It can speed up the process of establishing new varieties. Only a limited quantity of plant tissue is required as the initial explant. Tissue culture propagation ensures the availability of plants throughout the year. It helps in the production of uniform progeny from cross-pollinated plants. Disease free planting materials can be made available to the farmers. Special laboratory facilities and technical skill are essential for adopting this technique for mass multiplication of crop plants. Training in tissue culture is offered by various research organizations in Kerala.

### Procedure

Pipette out the required volume of stock solutions of chemicals into a one litre glass beaker. Add components like sucrose and myo-inositol as solid and allow them to dissolve. Make up the volume to approximately 950 ml with distilled water. Adjust the pH to the required value (5.6 to 5.8 for Murashige and Skoog basal medium) with a few drops of either alkali or acid, using a pH meter. Add the required quantity of agar and make up the

volume to 1.0 litre. Pour the solution into a glass beaker and heat, while stirring, until the agar is dissolved. Dispense the medium (5 to 15 ml) in test tubes or flasks and plug with cotton. Plastic lids or aluminum foil may also be used for the purpose. Culture jars may be plugged with plastic lids. Autoclave the vessels containing culture medium for 15 minutes at 1.06 kg/cm<sup>2</sup> pressure (121°C). While using a pressure cooker, wait for the continuous flow of pure steam, put the weight and sterilize for 20 minutes. Explants collected from field grown plants will have to be disinfected before inoculating in the culture medium. The explants are washed in running tap water first and then in soap solution. They are then surface sterilized and trimmed using sterile knives. The commonly used surface disinfectants are sodium hypochlorite (0.1 to 2.0 per cent for 15 to 30 minutes) and mercuric chloride (0.05 to 0.1 per cent for 3 to 20 minutes). The efficiency of the surface sterilant can be increased, by adding a few drops of surfactants. After surface sterilization, the explants should be washed with sterile distilled water four to five times to remove the residues. The explants are then transferred to the sterile culture media in vessels. This process is called inoculation. Surface disinfection and inoculation must be carried out in a laminar airflow chamber. This equipment can filter the air through a high efficiency particulate air (HEPA) filter of very small mesh size. This will remove bacteria and fungal spores. The steady outward flow of filtered air will ensure a sterile zone in the equipment, suitable for aseptic manipulations. The needles, forceps, blades and petri-dishes used for the manipulation of explants should be pre-sterilized.

The tools used in the airflow cabinet may be kept dipped in 70 per cent ethanol in a beaker and periodically flamed over a spirit lamp. After inoculating the explants in suitable culture media, the cultures are incubated in rooms under controlled conditions of temperature (26 + 2°C), light (200 lux, 18 hours) and humidity (60-80 per cent). Response of an explant largely depends on the composition of the culture medium. There are several basal media, which can be used for various needs with necessary modifications. The basal medium is selected to suit the plant species and the method of in vitro culture. In general, culture medium consists of salts of major and minor nutrient elements, vitamins, amino acids, plant growth substances and a source of carbon. The established cultures are sub-cultured to fresh media at intervals of 3 to 5 weeks. The media provided at each subculture decide the response of the tissue. Hardening the plantlets to make them adapt to the outside environment is a critical process, essentially due to the anatomical and

physiological peculiarities of the plantlets. A period of humidity acclimatization is necessary for the newly transferred plantlets to adapt to the outside environment, during which the plantlets undergo morphological and physiological adaptations, enabling them to develop typical terrestrial plant-water control mechanism.

Tissue culture techniques for mass multiplication have been standardized for crops like banana, pineapple, papaya, black pepper, cardamom, vanilla, orchids, anthurium, gladiolus and several medicinal plants. The commercial adoption of tissue culture clonal propagation is feasible only when the rate of multiplication is satisfactory and the cost of plantlets is acceptable to the farmers. Protocols for the tissue culture propagation of a number of crops like red banana, nendran, pineapple, orchid and anthurium, black pepper, vanilla, medicinal plants etc. have been developed at the Kerala Agricultural University and are available for commercial adoption.

## IMPROVING THE KEEPING QUALITY OF FRUITS AND VEGETABLES

About 30 to 40 per cent of the harvested fruits and vegetables are estimated to be lost due to improper harvesting, handling, storage and transportation in India. If proper care is taken during these operations, the loss can be minimized to some extent. Some of the techniques, which can be adopted, are as follows.

### Harvesting

- a. Harvesting must be done at the appropriate maturity depending up on the marketing distances and purpose.
- b. Harvesting must be done preferably in the morning hours or late evening to avoid
- c. exposure of the produce to excessive heat, which will hasten spoilage.
- d. Harvesting must be done preferably with proper harvesting devices suited to the commodity. For example, mango harvesters with cutting edges and plastic net can prevent the damage during harvest and collection.
- e. Avoid impact shock while harvesting fruits from tall trees; eg. jackfruit, mango etc. which will cause bruising, leading to infection.
- f. Avoid too loose or too tight packing in gunny bags while transporting harvested produces to minimize bruising.

### Packing

- a. Wash the harvested produce in plain water or in chlorinated water to clean it of the adhering mud, dirt and residual pesticides.
- b. Remove the infested, rotten and spoiled fruits.
- c. Grading the produce can improve market acceptability. This can be done at farmer's level or at collection points to suit the standards established by individuals, industry or government. Grading will also increase farmer's bargaining power, as they are likely to get premium prices for better-grade products. Similarly buyers can choose the grades they wish to buy. Possible grading can be based on colour, shape, size, weight etc. of the commodity.

### During storage

- a. Pre-cool the commodity immediately after harvest to reduce the field heat.
- b. Pre-packaging the commodity into unit packs can reduce the handling losses.

Some of the packaging techniques are (1) Packing of banana hands at 0.2 to 0.4 per cent ventilation with polyethylene cover of 150 gauge can increase the keeping quality upto 10 to 12 days under ambient conditions.

(2) Packing fresh mushroom (*Pleurotus* sp.) in 100 gauge polypropylene pouches without any ventilation can extend the storage life upto 36 hours at room temperature and up to 7 days under refrigerated conditions. (3) Fresh tomato can be stored up to 25 days under ambient conditions when packed with 35 to 40 per cent moistened saw dust in the ratio of 1:0.5 (tomato:saw dust). (4) Fresh mature and ripe sapota can be stored up to 6 days under ambient conditions when individually wrapped with cling film.

General storage methods practised to extend the keeping quality are:

1. By storing the commodity under optimum/low temperature and humidity.
2. By skin coating using wax emulsion containing permitted fungicides at optimum concentrations.
3. By adopting controlled/modified atmospheric storage modifying the oxygen/carbon dioxide ratio within the package.
4. By sub-atmospheric pressure storage.
5. By ventilated storage using ventilated films/bags.
6. Using evaporative cool chamber constructed to store temporarily the harvested produce at the field before marketing.

## LOW COST TECHNOLOGY FOR IRRIGATION AND PROTECTED CULTIVATION

### Magnetic treatment of irrigation water

The results indicated the beneficial effect of irrigation water treated with ceramic magnets on growth and yield of Cowpea, Brinjal and Bhindi crops under drip irrigation. Seventeen and 25% higher yield were reported for magnetically treated saline water (2000

ppm) and normal water respectively. BC ratio was found to be 1.65 and 1.91 for magnetically treated saline water and normal water respectively.

Magnetic treatment of irrigation water can be adopted in the following areas for improving the crop production.

Areas where saline or hard water is only available for irrigation.

Areas under drip irrigation

### KAU Micro sprinkler

KAU Micro sprinkler is a farmer friendly irrigation system, simple in design, with less clogging susceptibility, ensuring uniform wetting of the basin of the crops. The main component of the system is the rotating sprinkler head, made of a small piece of 12mm/8mm dia. LDPE pipe plugged at both ends by end caps. The length of pipe is 6cm for 12 mm pipe and 8cm for 8mm pipe. Nozzles

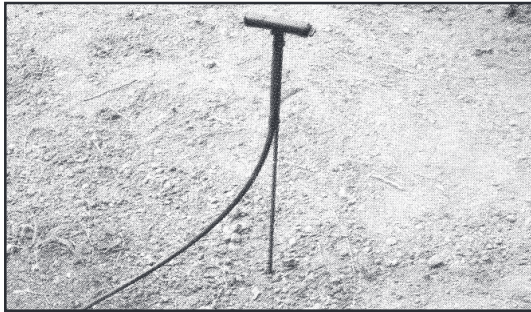

of 1mm diameter are drilled on opposite sides of the pipe, 5 mm away from both ends, at 90° from bottom. It is centrally attached to a 6 mm micro tube and then to the lateral of the pipe network through pin connectors. The micro tube with sprinkler head unit is held erect

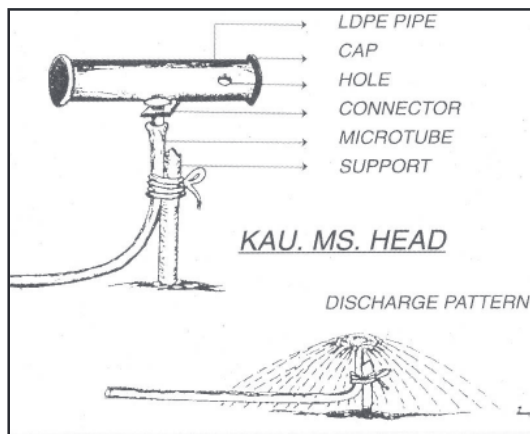

by tying to a riser pipe, fixed near the plant to be irrigated.

The maximum allowable length of laterals in this system is 50 m with about 20 sprinkler heads. An area of 1.0 ha can be irrigated in two splits by a 0.5 to 1.0 HP pumping unit with a pressure of 1.0 to 2.0 kg/cm<sup>2</sup>. The units are capable of discharging 35 to 45 lph with an area of coverage upto 2.5 m diameter. Coconut, Arecanut, banana, vegetables, vanilla, medicinal plants, lawns, ornamental plants etc. have been found to respond well to this system of irrigation with maximum efficiency.

### Low cost greenhouse for protected cultivation

Naturally ventilated greenhouse made of bamboo/arecanut/GI pipes and covered with UV stabilized polyethylene sheet are suitable for growing high value crops like cabbage, cauliflower, capsicum, tomato and cucumber round the year. Temperature and humidity build up inside the green house can be controlled by natural ventilation through insect proof nets (40-50 mesh) and by providing the required height to the structure. The optimum height of a greenhouse depends on floor area, ambient temperature, relative humidity, solar radiation and wind velocity of the locality.

### Design of low cost greenhouse

An optimal design of a low cost greenhouse suitable for homesteads of Kerala is a gable shaped structure with a floor area of 75 m<sup>2</sup> provided with roof and side ventilation. The structure should have a ridge height of 4.35 m and gutter height of 2.5 m. The roof slope should be around 30°, effective side ventilation not less than 30 per cent and effective roof ventilation not less than 9 per cent the floor area of the greenhouse. The temperature inside

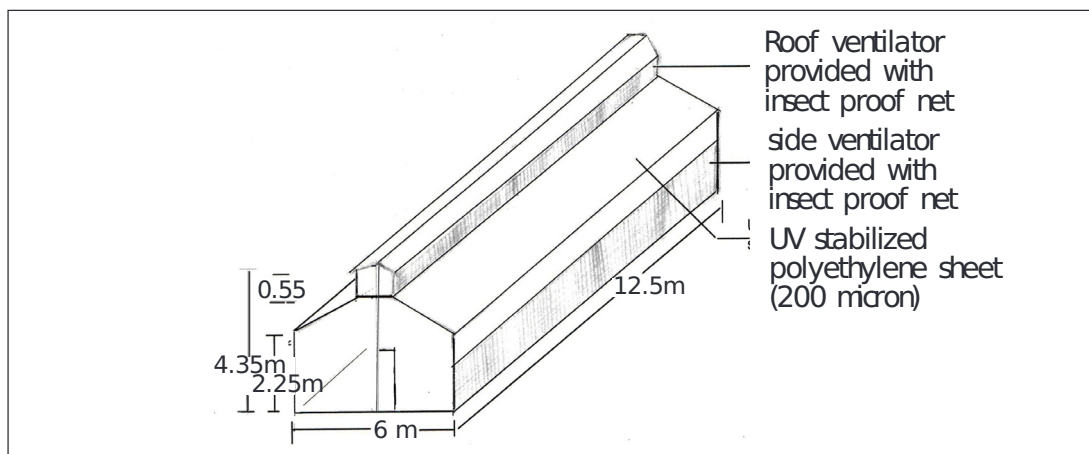

the greenhouse increase with increase in floor area and decreases with increase in height of the greenhouse. Hence height of greenhouse has to be increased with increase in floor area.

The structure can be made of arecanut/GI pipes/bamboo poles. The bamboo/arecanut poles should be treated with chlorpyrifos (0.2 per cent) to prevent termite attack. The structure should be covered with UV stabilized polyethylene sheet (200 micron) with at least 85 per cent light transmissibility. Side ventilators should be provided on either side of greenhouse at the floor level and roof ventilators should be provided at the top level throughout the length of the greenhouse as shown in figure. Ventilators should be provided with insect proof net. Crop yield under the naturally ventilated greengouse is generally 3.5 times more than that of open field. Insect and other pest

attack is limited to thrips and mites for which suitable control measures should be adopted. Off season production of vegetables is also possible in greenhouse which fetches a high market price to the farmer.

#### Rain shelter cultivation

Rain shelter is a low cost greenhouse. The frame of the rain shelter can be made of bamboo or arecanut palm poles and the roofing can be done with U. V. stabilized polythene sheet. The sides can be kept open to ensure ample ventilation or can be provided with insect proof netting or shade net. Permanent rain shelter with or without roof ventilation can also be utilized for growing vegetables during rainy season. Frame work can be made by GI pipes and cladding with UV stabilized film of 200 micron thickness.

## FARM MACHINERY SUITABLE FOR KERALA

### A. RICE MACHINERIES

#### KAU Helical Blade Puddler

KAU Helical Blade Puddler is an energy efficient tractor drawn implement for puddling wet lands. When used with a cage wheel

attached tractor, there is a saving of about 40 per cent time and a corresponding saving in fuel. The implement helps to avoid over puddling and achieve better soil condition suitable for mechanized transplanting. The other advantages are less distortion of

level of the paddy fields and enhanced life of cage wheels. The implement is easy to operate and can be manufactured locally.



Manually operated paddy transplanter

The improved IRRI six-row paddy transplanter is simple in construction and easy to operate. Six numbers of seedling mats of 20 cm x 50 cm size are placed in the transplanter tray, which is operated by a single person. It weighs only 20 kg. It is operated in puddled and leveled fields with a thin layer of water. Row spacing is 20 cm and hill spacing is adjustable. It covers approximately 0.1 ha/h and has a saving of 75 per cent labour and 70 per cent cost in transplanting.

#### Yanji Shakti 8-row rice transplanter

Rated speed: 2600 rpm; row number: 8; row spacing: 238 mm; distance between hills: 120-140 mm; number of seedling per hill: 3-8; suitable width of seedling mat: 2-20 mm; planting depth: 0.60 mm.

#### 5 HP self-propelled paddy reaper

The 5 HP diesel engine-operated improved IRRI reaper harvest paddy in 1 m width both in dry and wet fields of Kerala, except in sticky kole fields. A person operates it by walking behind the reaper. Maximum recovery of grain and straw is achieved.

It harvests broadcasted or transplanted non-lodged paddy. It is suitable for own use as well as for custom hiring. It covers approximately 0.18 ha/h and has saving of 85 per cent labour and 65 per cent cost in harvesting paddy.

#### Tractor operated paddy reaper

The tractor front mounted paddy reaper harvests broad casted or transplanted non-lodged paddy at a width of 2.2 m. Power is taken from PTO for cutting and conveying the crop and the hydraulic system is used for controlling the height of cutter bar. It is suited to all makes of tractor. Cage wheels and pneumatic wheels are used for wet and dry fields respectively. Maximum recovery of straw and grain is achieved. It is suitable for tractor owners for custom hiring. It covers approximately 0.4 ha/h and has a saving of 85 per cent labour and 65 per cent cost in harvesting.

#### Portable power-operated rasp-bar paddy thresher-cum-winner

The crop is fed in the thresher with modified concave powered by an 8 HP electric motor/engine. After threshing and winnowing it delivers straw, chaff, stone and clean paddy in separate outlets. It has good threshing and winnowing efficiency. It is suitable for paddy crops even with high moisture and long straw. Straw is not cut and damaged. It threshes crop from approximately 0.3 ha h<sup>-1</sup> (100 kg h<sup>-1</sup>) and has saving of 85 per cent labour and 60 per cent cost in threshing paddy. Transportation is done with Pneumatic wheels and suitable for custom hiring.

#### Rice Production Machinery for Pre-harvest operations

##### 1. Dry seeded system

Land preparation : Primary tillage operations may be undertaken using tractor operated



mould board plough or disc plough. Rotary tillage implements like power tiller (rotary tiller) or tractor operated rotavator can ensure better pulverisation and fine tilth for secondary tillage. Tractor operated rotavators are suitable for speedy operation with less energy expenditure. Tractor operated cultivator may also be used for preparatory ploughing to get a coarse tilth.

Seeding: Seeder attachment to cultivator may be made use of for dry seeding in rows. Line sowing in rows separated by 20 cm can enable optimum plant population and facilitate use of mechanical weeders.

### 2. Wet seeded system

Land preparation : Cage wheels are attached to power tillers and tractors to enable them to get sufficient traction in wet lands for puddling. KAU Helical blade puddler attached to tractor is an improved equipment for puddling wet lands. About 40-45% reduction in puddling time and 35-40% reduction in fuel consumption (per ha) can be achieved by the use of this puddler. Rotavator attached to tractor can also be used for puddling depending on the soil condition.

Seeding: Pre-germinated paddy wet seeder (drum seeder) can be used for line sowing of sprouted seeds in rows.

### 3. Transplanted system

Equipment for puddling is same as those recommended for wet seeded system.

#### Transplanting machines

Eight row self propelled riding type rice transplanter with a row to row spacing of about 23 cm is suitable for fields with low bunds. Four wheel type 6 row and 8 row transplanters with a row spacing of 30 cm is suitable if the field size is sufficiently large. Walk behind type four row transplanters are women friendly and easy to transport. Field capacities of popular

machines vary from 0.1-0.4 ha/h depending on the type of machine and field condition.

#### Mat nursery

Mat type nursery should be prepared carefully by sowing sprouted seeds on seed beds of about 700 -100 mm width made by spreading about 12 mm thick soil layer on a polythene sheet of appropriate length. Mat nursery may be prepared as dry nursery as well as wet. Dry nursery can be prepared on rigid flat surfaces also without using polyethylene sheets (Refer page 37 for details).

#### Weeding implements

Different types of wet land weeders are available. Double rotor cono weeder and Single rotor finger type weeder are commonly used for wet land weeding. Single rotor weeders are more suitable in heavy soils where cono weeders are difficult to be pushed.

#### Reaping machine

KAMCO reaper KR 120 is suitable for operation in fairly dry condition. The machine is powered by a petrol start kerosene run 3.5 hp engine. The cutting width is 120 cm and is capable of reaping and windrowing about 0.1-0.25 ha/h depending on field condition.

#### Threshing machines

##### Hold-on type

This is a simple thresher powered with a 1.5 hp electric motor and capable of threshing @ 50-100 kg threshed grain per hour.

##### Flow through Rasp bar thresher

The cut crop flow through the thresher fitted with rasp bar type of threshing cylinder and is fitted with cleaning mechanism. The machine works on a diesel engine or electric motor in a power range of 5-7.5 hp. This high capacity thresher can thresh about

350-450 kg of grain per hour and can be towed to the field when fitted with pneumatic wheels.

#### Axial flow threshers

Axial flow threshers with independent power source (Engine or electric motor) as well as those which can be operated with power from tractor PTO are also suitable for threshing.

#### Rice Combine Harvesters

##### Track type Flow through thresher combines

High capacity track type rice combines with flow-through threshing mechanism are suitable for slushy field conditions. The machines are powered with diesel engines of 55-60 hp with a cutting width of 2.4 m and a field capacity of about 0.4 ha per hour. The cut crop is fully conveyed into the threshing unit and the cleaned grain is temporarily stored in the grain tank of about 1 tonne capacity. The bruised straw is discharged to the field and difficult to be bundled.

##### Track type ear head thresher combine

Small track type combines with ear head threshers have better maneuverability in small fields. The machines are generally powered by a 30-40 hp diesel engines and have a cutting width of about 140 cm. The cut crop is conveyed by the help of moving fingers and conveyors to the threshing unit so as to hold the ear heads against the rotating threshing cylinder. The straw is not bruised and is windrowed behind in a row. The threshed and cleaned grain can be collected in gunny bags which are held at the sack holder of the machine. It has limitations in highly slushy fields. Machines with grain tank are also available.

##### Wheel type combines

Many wheel type combines manufactured in India are suitable for harvesting paddy when

the field is dry enough for their operation. The field capacity is comparable to other high capacity track type combines and their initial cost as well as maintenance cost is comparatively low.

#### Straw balers

Two types of balers are available for collection of straw from combine harvested fields, viz. round baler and rectangular baler. Tractor PTO operated round balers are suitable for small fields. Tractor PTO operated offset mounted rectangular straw balers are better suited for large plots of more than 0.2 ha.

#### Three row power weeder for paddy

The three row power operated paddy weeder with finger type rotor is a farmer friendly gadget for mechanical weeding in machine transplanted rice fields. An area of 0.02 ha can be operated in one hour by a single labourer using the power weeder. The first operation is to be done at 15 to 20 days after transplanting. A second operation may be done if necessary at 15 days after first operation.

Kaipad bed former & KAU bed former suitable to mini tractor

Kaipad region consists of swampy water logged areas experiencing flood during monsoon and salinity during summer owing to the proximity to estuaries. In Kaipad rice cultivation, the conventional practice of raising nursery is by sowing pre germinated paddy seeds on manually prepared mounds using spade, which is laborious, tedious and time consuming operation. In order to overcome these problems, a bed former as an attachment to a tractor was developed and field tested. It consists of tractor drawn suitably designed curved tynes and forming boards, main frame attached to 3-point linkage of tractor. The two forming boards were fitted on a standard

frame. The weight of the entire forming boards with frame was 135 kg. This can be attached to a light weight 4-wheel tractor of 34 hp. The field capacity of the machine was 0.20 ha h<sup>-1</sup> with a field efficiency of 74%. Cost reduced to 50% compared to conventional method.

#### B. OTHER MACHINERIES/TECHNOLOGIES

##### KAU jack-fruit harvester

This consists of two sub-units as adjustable telescopic long handle with a hood knife at the outer end and a basket suspended from a nylon rope. The basket can be placed just around the fruit by a handle and rope and then harvested into it for safe lowering. It can be used for normal and medium tall trees. With two people, a fruit can be harvested in 4-5 minutes. Weight is 4-5 kg (if made of aluminium).

##### Rotary Banana Slicer

A motor operated rotary banana slicing machine suitable for slicing Nendran variety of banana has been developed at KCAET Tavanur. It is a user-friendly machine, capable of slicing banana at desired thickness directly into the frying pan. The variable speed motor drive helps to alter the capacity of the slicer as per the requirement (100 to 110 kg/hr). The lateral movement of the slicer unit is possible to and fro over the frying pan adding convenience in operation.

##### Petti and para

The petti and para is used very widely to dewater the low-lying kole lands and Kuttanad padasekharams. The optimum speed for high level of efficiency at relatively higher head (100-200 cm) has been found to be 330-340 rpm for a 15 HP pump. Beyond 340 rpm, the pump gets overloaded. When not operated at optimum speeds, it incurs energy loss.

##### Coconut husking tool

This consists of a stationary wedge, a movable wedge, a lever and a pedestal having a base. The stationary wedge is mounted upright on top of the pedestal at a convenient height. Bottom of the movable wedge is hinged to the bottom of the stationary wedge facilitating its opening and closing. The lever fixed to the movable wedge provides the necessary mechanical advantage needed in husking. Self-weight of the lever forces the wedges to remain together forming a large wedge. Holding the coconut with both hands, it is thrust onto the wedge piercing the husk at its Pedicel end and parallel to its longitudinal axis. On pulling the lever upwards, a section of the husk is prized out. By repeating this action at different points across the nut, the husk can easily be removed. The trade name is Keramithra.

**Black Pepper Decorticator :** The stainless steel machine is based on the principle of churning and centrifugal action to the presoaked berries. The water jet enhances the smooth decortication without any breakage. The decorticating efficiency of this machine is 91.8% at 142 rpm for 7 days soaked berries. The capacity is 14 kg/h.



The main parts and machine specifications are as follows:

1. Main parts
  - a. Decorticating drum
  - b. Feed hopper
  - c. Collecting tray and outlet arrangement
  - d. Water supply system
  - e. Main shaft
2. Machine specifications

Number of spikes - 20,

Power - 0.5hp, single, 1440 rpm

Power Operated Nutmeg Sheller

The machine is based on the principle of centrifugal impact. It consists of shelling unit, cleaning unit and power transmission unit. The capacity of the machine is found to be 135 kg/h. The shelling efficiency is 93% and the cleaning efficiency is 70%.

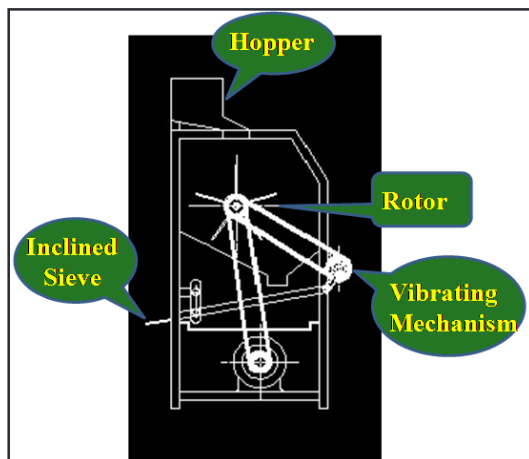

Udyanamithra  
(Garden transplanting tool)

'Udyanamithra' is a simple hand operated transplanting tool. Seedlings can be transplanted using Udyanamithra without any shock. The seedling with the soil core containing its root zone is transferred without



Garden transplanting tool

any disturbance to a circular pit which is dug by the same tool. The tool is useful for seedlings up to an age of two weeks and about 20-25 seedlings can be transplanted in an hour if the distance is within 10 meters (capacity is variable depending on distance from nursery to pit). The tool is very useful for gap filling of vegetables and for transferring rootstocks to polythene bags.

Seed extractor for Ash gourd and Cucumber

The machine is developed for extracting seeds from ash gourd and cucumber. The principle of operation is penetrating the extracting tool so that the seeds can be extracted without affecting the mesocarp. The diameter of the extraction tool can be varied according to the placental diameter of the commodity. The seed extraction efficiencies of both these vegetables were in the range of 99 to 100%. The germination rates were 83% for ash gourd seeds and 90% for cucumber seeds. The capacity of the extractor for ash gourd is 350 kg/h and that of cucumber is 215 kg/h.

Coleus peeler

Peeling of Coleus tubers is very difficult and time consuming process in culinary purpose. The manual peeling causes stain, itching and drudgery to the fingers. A simple

and low cost device was hence developed and tested as an attachment to the commercially available table top wet grinders. It consists of a peeling unit and a directing rod. The peeling unit is made of stainless steel mesh considering minimum breakage and maximum peeling of the coleus. The directing rod is fixed at the centre of the rotating drum. The raw coleus is fed in to the rotating drum and sufficient quantity of water is added to it. When switched on, the directing rod passes the coleus and gets in contact with the peeling mesh. Capacity of the peeler is 15 kg per hour.

#### KAU portable split biogas plant

The KAU split portable biogas plant is an eco-friendly gadget for energy conversion of domestic organic wastes. The system is more hygienic than the ordinary portable biogas plants. The sealed digester and the gas holder can be kept separately. The system can be fabricated in digester capacities ranging from 500 to 1000 litres. Approximately 50 litres/day of biogas is produced for every kg/day of organic wastes added.

#### High rate anaerobic bioreactors for biomethanation of organic effluents from agro industries

The high rate biogas system viz. Upflow anaerobic hybrid bioreactor is an eco-friendly technology for energy conversion of high volume low strength organic effluents from agro processing industries. The system is less costly compared to similar systems as there is possibility for the use of locally available

agricultural by-products like coconut shells as media for cell immobilization. The hydraulic retention time of the system can be reduced to the tune of 4-8 days and a corresponding reduction in digester volume has the advantages of cost and space reduction. The twin advantages are waste management along with energy production.

#### Goat faecal pellet pulverizer

The goat faecal pellets cannot be used directly as it will not disintegrate easily with soil. It needs to be pulverized especially for making pot mixture and for easy application as FYM. It consists of a prime mover, hopper, pulverizer and power transmission unit. The drive from the prime mover is transferred to the pulverizer through belt and pulley arrangement. The pulverizer comprises of beaters mounted on a horizontal shaft and a stationary drum. A sieve is provided at the bottom of the stationary drum. The beater is made of a M S flat fitted with semi-circular sheet, which is provided with projections in staggered manner. The projections on the beater and sieve are too closer, so that the dried faecal pellet get crushed inside the drum and expelled through the sieve. The faecal matter will remain inside the drum until it attains a size smaller than the sieve size. The powdered matter will be forced out through the outlet chute. An outlet chute is provided at the bottom of the sieve so that powdered faecal matter is obtained without any loss. The capacity of the machine is around 45 kg per hour.

## Appendix 1

## AGROCLIMATIC CLASSIFICATION OF KERALA

Agroclimatic zones identified by superimposing six moisture availability regimes over seven soil groups

S. No.	Zones	Location	Crops grown
1	2	3	4
1.	Dry Forest Loam	In and around Chinnar	Plantation crops other than spices, coconut and tapioca
2	Semi Dry Red loam	Isolated pockets in Thiruvananthapuram and Neyyattinkara Taluks	Coconut, tapioca, paddy and fruit plants like cashew and mango
3.	Semi Dry Laterite	Parts of Kollam, Chirayinkil, Thiruvananthapuram, Neyyattinkara & Nedumangad taluk	Paddy, coconut and fruit crops like mango and cashew
4.	Semi Dry Alluvium	River beds and coastal areas of Kollam, Chirayinkil, Thiruvananthapuram, Neyyattinkara, Ottappalam, Thalappilly, Palakkad and Alathur taluks	Paddy, coconut, tapioca, mango and cashew
5.	Semi Dry Black soil	Eastern most parts of Chittur and Palakkad taluks	Paddy, cotton and coconut
6.	Semi Dry Forest Loam	Kumily and parts of Peerumedu taluk	Tapioca, tea, coffee and rubber
7.	Sub humid Red loam	Kasaragod and Kannur; Parts of Kasaragod, Hosdurg and Taliparamba taluks	Coconut, cashew, paddy, rubber, pepper and arecanut
8.	Sub humid Laterite	Parts of Kannur, Tirur, Choughat, Parur, Kasaragod, Hosdurg, Taliparamba, Tellichery, Badagara, Talappilly, Thrissur, Mukundapuram, Aluva, Kanayannur, Alathur, Chittur, Emad, Mannarghat, Palakkad, Kunnathur, Kottarakkara, Pathanapuram, Neyyattinkara and Nedumangad taluks	Paddy, coconut, rubber, cashew, pepper, arecanut, tapioca and mango
9.	Sub humid Alluvium	Coastal areas and river beds in the regions under item 8	Paddy, coconut, mango, cashew, rubber, pepper, arecanut and tapioca
10.	Sub humid Saline	Pokkali lands in the coastal parts of Parur, Kanayannur and Cochin taluks	Paddy and coconut

1	2	3	4
11.	Sub humid forest loam	Parts of Emad, Mannarghat, Devikulam and Pathanapuram taluks	Pepper; tea, cardamom, tapioca and paddy
12.	Humid laterite	Parts of Kasaragod, Taliparamba, Tellicherry, Quilandy, Kozhikode, Badagara, Kunnathunad, Meenachil, Kanjirappally, Pathanamthitta, Chengannur, Mavelikkara and Nedumangad taluk	Vegetables, nutmeg, cashew, fodder grass and pineapple
13.	Humid Alluvium	River beds of taluk areas described under item 12, western part of Chengannur and Mavelikkara taluks, coastal areas of Cherthala, Ambalapuzha and Karunagappally taluks	Paddy, coconut, cocoa, tapioca, arecanut, mango and banana
14.	Humid Greyish Onattukara	Onattukara - parts of Mavelikkara, Karunagappally and Karthikappally taluks	Paddy, coconut, sesamum and tapioca
15.	Humid saline	Around Vembanad lake (Areas with acid saline soils)	Paddy and coconut
16.	Humid forest loam	Parts of Emad, South Wayanad and North Wayanad, Kasaragod, Hosdurg, Taliparamba taluks; Tellicherry, Pathanamthitta, Pathanapuram, Neyyattinkara, Devikulam and Peerumedu taluks	Coffee, tea, pepper, cardamom, rubber, ginger, paddy, mango and jack
17.	Per-Humid laterite	Parts of S.Wayanad, Quilandy, Emad, Kunnathunad, Devikulam, Thodupuzha Kothamangalam, Meenachil and Kanjirappally taluks	Paddy, coconut, tapioca, rubber, pepper, arecanut, cocoa, mango, jack, cashew, ginger and banana
18.	Per-Humid Forest loam	A small pocket in and around Vythiri, parts of Devikulam, Thodupuzha and Peerumedu taluk	Paddy, coconut, coffee, tapioca, pepper, tea, cocoa and cardamom
19.	Wet laterite	Parts of South Wayanad, Emad, Mukundapuram, Devikulam, Peerumedu, Pathanamthitta taluk	Cardamom, tea, coffee, rubber, pepper, tapioca, ginger and paddy
20.	Wet Forest Loam	Parts of Neriamangalam, Devikulam, Thodupuzha, Kanjirappally, Meenachil and Peerumedu Taluk	Paddy, tapioca, pepper, tea, coffee and cardamom

## Appendix 2

### AVERAGE NUTRIENT CONTENT OF COMMON MANURES AND FERTILIZERS

Material	Nutrient content (%)		
	N	P <sub>2</sub> O <sub>5</sub>	K <sub>2</sub> O
Ammonium sulphate	20.5	-	-
Ammonium sulphate nitrate	26.0	-	-
Ammonium nitrate	33.5	-	-
Ammonium phosphate	20.0	20.0	-
Calcium ammonium nitrate	20.5/25.0	-	-
Nitrate of soda	16.5	-	-
Urea	46.0	-	-
Superphosphate (single)	-	18.0	-
Superphosphate (double)	-	35.0	-
Superphosphate (triple)	-	46.0	-
Mussooriephos	-	18-20	-
Rajphos	-	18-20	-
Muriate of potash	-	-	50/60
Bone meal	3.5	21.0	-
Fish meal	4.1	3.9	0.3-1.5
Poultry manure	1.2-1.5	1.4-1.8	0.8-0.9
Sheep manure	0.8-1.6	0.3-0.4	0.3-0.4
FYM	1.0	0.5	1.0
Compost	0.5	0.4	0.8
Groundnut cake	7.0	1.5	1.5
Castor cake	4.3	2.0	1.3
Neem cake	5.0	1.0	1.5
Gingelly cake	6.2	2.0	1.2
Coconut cake	3.0	1.9	1.8

Note: Composition of organic manures vary widely

## Appendix 3

### NEUTRALIZING VALUE OF LIMING MATERIALS

Liming material	Chemical formula	Neutralizing value
Calcium carbonate (powdered lime stone)	CaCO <sub>3</sub>	100
Burnt lime (quick lime)	CaO	179
Slaked lime	Ca(OH) <sub>2</sub>	136
Dolomite	CaMg(CO <sub>3</sub> ) <sub>2</sub>	109



### Appendix 4

#### CONVERSION OF NUTRIENTS (kg ha<sup>-1</sup>) TO COMMON FERTILIZERS (kg ha<sup>-1</sup>)

Rate of application	Ammonium sulphate (20% N)	Urea (46% N)	Superphosphate (18% P <sub>2</sub> O <sub>5</sub> )	Muriate of potash	
				(50% K <sub>2</sub> O)	(60% K <sub>2</sub> O)
10	50	22	56	20	17
20	100	43	111	40	33
30	150	65	167	60	50
40	200	87	222	80	67
50	250	109	278	100	83
60	300	130	333	120	100
70	350	152	389	140	117
80	400	174	444	160	133
90	450	196	500	180	150
100	500	217	556	200	167
110	550	239	611	220	183
120	600	261	667	240	200
130	650	283	722	260	217
140	700	304	778	280	233
150	750	326	833	300	250

### Appendix 5

#### GUIDE FOR MIXING FERTILIZERS

Muriate of Potash	Potassium Sulphate	Ammonium Sulphate	Calcium ammonium nitrate	Sodium nitrate	Urea	Super-phosphate	Ammonium phosphate	Calcium carbonate	
Ö	Ö	Ö	y	y	y	Ö	Ö	Ö	Muriate of potash
Ö	Ö	Ö	y	y	y	Ö	Ö	Ö	Potassium sulphate
Ö	Ö	Ö	Ö	y	y	Ö	Ö	X	Ammonium sulphate
y	y	Ö	Ö	y	y	y	y	Ö	Calcium ammonium nitrate
y	y	Ö	Ö	Ö	y	y	y	Ö	Sodium nitrate
y	y	y	y	y	Ö	y	y	y	Urea
Ö	Ö	Ö	y	y	y	Ö	Ö	X	Superphosphate
Ö	Ö	Ö	y	y	y	Ö	Ö	X	Ammonium phosphate
Ö	Ö	X	Ö	Ö	y	X	X	Ö	Calcium carbonate

Ö Can be mixed  
 y May be mixed only prior to application  
 X Should not be mixed

## Appendix 6

### CALCULATION OF INSECTICIDE AND FUNGICIDE FORMULATIONS

#### A. Calculation of insecticide formulation

##### 1. Sprayable formulation

Quantity of insecticide formulation =

$$\frac{\text{Strength (per cent) required} \times \text{Quantity of spray solution required (l)}}{\text{Strength (per cent) of formulation}}$$

eg. :- Malathion 50 EC @ 0.2% required to prepare 10 litres (10,000 ml) of spray solution

$$= \frac{0.2 \times 10 \times 1000}{50} = 40 \text{ ml}$$

##### 2. Granular formulation

Quantity of granular formulation (kg) =

$$\frac{100 \times \text{recommended rate (kg a.i ha}^{-1}) \times \text{Area (ha)}}{\% \text{ a.i in the commercial formulation}}$$

eg. :- cartap hydrochloride 4 G required to apply in one hectare @ 750 g a.i ha<sup>-1</sup>

$$= \frac{100 \times 0.75 \times 1}{4} = 18.75 \text{ kg}$$

#### B. Calculation of fungicide formulations

##### 1. Wettable powder (WP)

eg. :- carbendazim 50 WP (0.1%)

Dissolve 1 g carbendazim 50 WP in 1 litre of water.

##### 2. Emulsifiable concentrate (EC)

eg. :- Kitazin 48 EC (0.1%)

Dissolve 1 ml Kitazin - 48 EC in 1 litre of water

## Appendix 7

### HOME MADE INSECTICIDAL PREPARATIONS

#### KEROSENE EMULSION

##### Materials required

- Kerosene - 900 ml
- Bar soap - 50 g
- Water - 20 litre

##### Method of preparation

Slice 50 g bar soap into fine flakes and dissolve in 450 ml of boiling water. Cool it and then add to 900 ml kerosene under violent agitation till the oil is fully emulsified. Dilute this stock solution by adding 15-20 litres of water for spraying. It is effective against many sucking insects.

#### TOBACCO DECOCTION

##### Materials required

- Tobacco waste - 100 g
- Bar soap - 24 g
- Water - 6 litre

##### Method of preparation

Soak 100 g of tobacco waste in 900 ml of water for 24 hours. Then squeeze the tobacco waste and remove all debris by filtering the extract through a muslin cloth or a strainer. Slice 24 g of bar soap into thin flakes and dissolve in 100 ml of water in another vessel. Pour the soap solution into the tobacco decoction under violent agitation. Dilute this stock solution by adding 6 litres of water. This can be recommended for managing aphids and other soft bodied insects infesting vegetable crops.

#### NEEM SEED KERNEL EXTRACT (NSKE 3%)

##### Materials required

- Neem seed kernel - 30 g
- Water - 1 litre

##### Method of preparation

Grind neem seed kernel into coarse powder and put it in a small muslin cloth bag. Keep it immersed in 1 litre of water in a vessel for 12 hours. Thereafter, squeeze the cloth bag by dipping in water repeatedly till the water coming out from the cloth bag becomes clear. Squeeze the cloth bag thoroughly and then remove it. Now the 3% NSKE is ready for spraying.

#### NEEM OIL - GARLIC EMULSION (2%)

##### Materials required

- Neem oil - 200 ml
- Bar soap - 50 g
- Garlic - 200 g
- Water - 9 litre

##### Method of preparation

Slice 50 g bar soap into thin flakes and dissolve in 500 ml of hot water by agitation. Pour the soap solution to 200 ml of neem oil slowly and stir rigorously. Grind 200 g of garlic by adding 300 ml of water. Filter the garlic extract through a muslin cloth and then add to the prepared neem oil soap emulsion. Dilute this one litre stock solution by adding 9 litre of water to get 10 litres of 2% neem oil - garlic emulsion.

## Appendix 8

### PREPARATION OF COMMON FUNGICIDES

#### Bordeaux mixture (1%)

Dissolve 1 kg of powdered copper sulphate crystals in 50 litres of water. In another 50 litres of water, prepare milk of lime with 1 kg of quick lime. Pour the copper sulphate solution into the milk of lime slowly stirring the mixture all the while. Test the mixture before use for the presence of free copper, which is harmful to the plants, by dipping a polished knife in it. If the blade shows a reddish colour due to the deposits of copper, add more lime till the blade is not stained on dipping. Always use wooden, earthen or copper vessels for the preparation of Bordeaux mixture.

In order to confer sticking quality to Bordeaux mixture, rosin washing soda mixture, may be added. The addition of the sticker is particularly recommended for spraying conducted during rainy season. For preparing the mixture, 10 litres of water out of 100 litres required for preparing Bordeaux mixture may be kept apart. Boil 10 litres of water, preferably in an earthen pot and add 500 g of good quality washing soda (sodium carbonate). Boil again until the solution becomes slightly dark in colour. Add 1 kg of powdered rosin (arpoons) in the boiling washing soda solution. Reduce the flame for avoiding frothing, foaming and spilling over. Boil the solution for 5-10 minutes till black bubbles appear. Cool the solution until the temperature reaches below 45°C. The cooled mixture (10 litres) is then added slowly to the prepared Bordeaux mixture (90 litres) under vigorous stirring.

#### Bordeaux paste

Dissolve 100 g of copper sulphate and 100 g of quick lime each in 500 ml of water separately. Mix together to make one litre of the paste.

#### Cheshunt compound

Weigh 60 g copper sulphate and 330 g of ammonium carbonate. These two are well powdered and thoroughly mixed. The dry mixture is stored in an airtight glass container for 24 hours before use. About 25 g of this mixture is dissolved in a little hot water and solution is made up to 8 litres with cold water and used for soil drenching.

## Appendix 9

### FUMIGANTS AND ITS USE

(For restricted use only)

#### Aluminium phosphide

Aluminium phosphide can be used for fumigating rat burrows and for control of pests infesting stored grains. This is available as 'Celphos' or as 'Aluminium Phosphide' tablets (3g) or pellets. For rat control, locate the burrows which contain live rats. For this, seal all burrow openings with mud in evenings and examine the closed burrows next day. If the mud seal is opened, such burrows are marked as live ones. In such live burrows, introduce aluminium phosphide tablets @ 1-2 per burrow and seal off the openings immediately. For fumigating grains and grain products under cover, use aluminium phosphide @ 1-2 tablets per tonne of grains, giving an exposure period of 5 days followed by aeration for a day. For room fumigation, use 5-7 tablets for every 28 cubic metre storage space. This has to be used under strict supervision of the approved pest control operators.

## Appendix 10

### PESTICIDE GUIDE

The pesticides may be applied according to the severity of infestation of the pest/ infection of the disease in a need-based manner. Whenever the government bans a chemical, recommendation for its use automatically stands cancelled. Central Insecticide Board and Registration Committee, Government of India has published the list of pesticide formulations banned in India in its official website (<http://cibrc.gov.in>). This list is periodically updated by CIB & RC which will stand applicable to the KAU recommendations, as and when modified. List of Pesticides/Pesticide formulations banned in India as given in Appendix 12.

Generic name	Trade name and formulation	Dosage/ha			Remarks
		a.i (g/ha)	Formulation g/kg or ml/l per ha	Per cent concentration (in 500 l water/ha)	
1	2	3	4	5	
<b>A. INSECTICIDES</b>					
<b>1. Carbamates</b>					
Carbosulfan	Marshal 6 G Marshal 25 EC	1000	16.67 kg 800-1000 ml		Effective against rice stem borer, gall midge and leaf folder
Thiodicarb	Larvin 50 WP Spiro 50 WP	750	1000		Cucurbits Epilachna beetle
<b>2. Organophosphorous compounds</b>					
Malathion	Cythion 5 DP  Malamar 50 EC Cythion 50 EC Star Mal 50 EC Malathion 50 EC Malatox 50 EC Miltion 50 EC	500  500-750	10 kg  1000-1500 ml	0.1-0.15	Safe insecticide for controlling pests of vegetables and storage pests. For control of pests of vegetables
Dichlorvos (DDVP)	Vapona 76 EC Nuvan 76 EC Luvon 76 EC Dash 76 EC Doom 76 EC	330	435 ml	0.05	Contact and fumigant, less residual; toxicity lasts for only 24 hours; safer to be applied on vegetables. Effective against rice leaf folder.

1	2	3		4	5
Quinalphos	Quinalphos 1.5 DP	300	20 kg		Broad spectrum insecticide; particularly effective against mealy bugs and scale insects.
	Quinalphos 5G Kinalux 5G	250	5 kg		For control of rice gall midge
	Quinalphos 25 EC Kinalux 25 EC Ekalux 25 EC Milux 25 EC Flash 25 EC	250	1000 ml	0.05	For control of rice pests and cardamom thrips.
Phosalone	Zolone 35 EC	350	1000 ml	0.07	Broad spectrum insecticide cum acaricide, effective against brown plant hopper
Dimethoate	Rogor 30 EC Tara 909 30 EC Killex- Dimethoate 30 EC Corothioate 30 EC Rogorin 30 EC	200- 700	660- 2330 ml	0.04- 0.14	Systemic insecticide cum nematocide.
	Nugor 30 EC Hilthoate 30 EC	0.2% suspension	3.3 L in 500 L water	0.2	For seedling dip against rice nematode
		0.05% suspension	833 ml in 500 L water	0.05	For foliar application against thrips
Chlorpyrifos	Dursban 20 EC Classic 20 EC Radar 20 EC Lethal 20 EC Coroban 230 EC Hilban 20 EC Tafaban 20 EC	100-300	500 - 1500 ml	0.06	Effective against stem borer and gall fly. Useful for root dipping.
		0.2% suspension	5 L in 500 L water	0.2	Geminated seed dip for 3 h against gall midge
		0.02% suspension	500 ml in 500 L water	0.02	Seedling root dip for 12 h against gall midge
Acephate	Asataf 75 SP Starthene 75 SP Lancer 75 SP Miltaf 75 SP	500-750	666-1000 g	0.1- 0.15	Effective against rice leaf folders and brown plant hoppers. Safe to green mirid bug (BPH predator).

1	2	3	4	5	
3. Neonicotinoids					
Imidacloprid	Confidor 17.8 SL Tatamida 17.8 SL Imidagold 17.8 SL Media 17.8 SL	30	150 ml	0.006	Effective against brown plant hopper:
Thiamethoxam	Actara 25 WDG	25	100 g	0.005	Effective against brown plant hopper and safe to green mirid bug (BPH predator)
	Suckgan 25 WG	50	200		Brinjal, Bhindi and Chilli sucking pests-whiteflies, jassids, thrips and mites
Acetamiprid	Manik 20% SP Pride 20% SP Rekord 20% SP	10	50		Brinjal sucking pests-whiteflies, jassids and mites
Thiaclopride	Alanto 20.7% SC Splendour	30	125		Pulses-Aphids and pod bugs
4. Oxadiazines					
Indoxacarb	Avaunt 15.8 EC Dhawa gold 15.8 EC	30	200 ml	0.006	Effective against rice stem borer, whorl maggot, leaf folder, blue beetle gall midge & case worm
Indoxacarb	Daksh, Kaal 14.5% SC Doxagan, Sarvada	75	520 ml		
5. Spinosyns					
Spinosad	Tracer 45 SC Spintor 45 SC Conserve 45 SC	100 ml	0.009		Effective against rice stem borer, whorl maggot, leaf folder, blue beetle gall midge & case worm
6. Neriostoxin analogues					
Cartap hydrochloride	Cartox 4 G Caldan 4 G Indan 4 G Kildon 4 G Bildan 4 G	1000  500	25 kg  20 g+200 g sand	  0.1	Effective against rice stem borer and leaf folder  Coconut Rhinoceros beetle
	Cartox 50 SP Bildan 50 SP Caldan 50 SP Kildon 50 SP		1 kg		Rice stem borer and leaf folder



1	2	3	4	5	
7. Ryanodine analogues (Bisamide/ Diamide)					
Fluben- dianide	Takumi 20WDG	25	125g	0.005	Effective against rice stem borer; whorl maggot and leaf folder
	Fame 480 SC	25	50ml	0.005	Effective against rice stem borer; whorl maggot and leaf folder
Chlorantranil prole	Ferterra 0.4% G			10kg/ha	Rice stem borer; gall midge, leaf folder and case worm
Chlorantranil prole	Coragen 18.5% SC		150ml/ha		Rice stem borer; leaf folder and case worm
8. Synthetic pyrethroids					
Lambda cyhalothrin	Karate 5 EC Reeva 5 EC		0.6ml/L	0.003	Foliar spray against tea mosquito bug
Tetronic and Tetramic acid derivatives					
Spiromesifen	Oberon 22.9% SC	96	400		Chilli mites and thrips
Mitochondrial complex 1 electron transport inhibitors					
Fenpyroxi- mate	Mitigate 5% EC Sedna 5% EC	15	300		Chilli mites and thrips
Inhibitors of mitochondrial ATP synthetase					
Diafenthuron	Pegasus 50% WP Polo 50% WP	300	600		Brinjal sucking pests- whiteflies, jassids and mites
Inhibitors of chitin biosynthesis					
Buprofezin	Apple 25% SC Banzo 25% SC Bipimain 25% SC Koram 25% SC Applaus 25% SC Swaltrust 25% SC Jawa™ 25% SC		–	800	Rice brown plant hopper
Avermectins					
Emamectin Benzoate	Proclaim 5% SC Pluto 5% SC Prabhaav 5% SC	10	200		Brinjal fruit and shoot borer

1	2	3	4	5	
B. FUNGICIDES					
1. Copper based products					
Copper oxychloride	Blitox 50 WP Blue Copper 50 WP Cupramar 50 WP Copper 50 WP Fytolan 50 WP Starcop 50 WP Killex copper fungicide 50 WP	500 - 750	1000 - 1500 g	0.1 - 0.15	Foliar spray and soil drenching
Copper hydroxide	Kocide 77 WP	385 - 578	500 - 750 g	0.08 - 0.12	Foliar spray against false smut of rice at the time of 50% flowering stage
Copper hydroxide	Kocide 101 WP	500 - 750	500 - 750 g	0.10 - 0.15	Foliar spray against sheath rot and glume discoloration
2. Sulphur based products					
Sulphur	Cosan 80 WP Esso Wettable Sulphur 80 WP Thiovit 80 WP Microsul 80 WG	800 - 1600	1000 - 2000 g	0.16 - 0.32	For foliar spray against powdery mildew. Also effective against mite.
Dithio carbamates and others					
Thiram (tetramethyl thiuram disulphide)	Thiride 75 WS Hexathir 75 WS JK Thiram 75 WS	2.25 - 3 g/kg of seed	--	--	For seed treatment
Mancozeb (zinc ions & manganese ethylene bisdithio-carbamate)	Indofil M-45 75 WP Dithane M-45-75 WP Hilthane M-45-75 WP Uthane M-45-75 WP Manzeb 75 WP	1125 - 1500	1500 - 2000	0.225 - 0.3	Foliar fungicide
Propineb	Antracol 50 WP	625	1250 g	0.125	For the management of glume discoloration and brown spot of rice

1	2	3	4	5	
3. Chlorinated nitrobenzene					
Dinocap	Karathane 48EC	480	1000 ml	01	as foliar spray for powdery mildew control of cucurbits and rose
4. Heterocyclic nitrogen compounds					
Captan	Captan 75 WP Hexacap 75 WP	1125- 1500	1500- 2000 g	0.225- 0.3	For seed treatment at 1.5 g per kg of seed
5. Phenyl urea fungicides					
Pencycuron	Monceren 250SC	1875	750 ml	0.375	sheath blight of rice
6. Systemic fungicides					
Carben- dazim	Bavistin 50 WP B-Stin 50 WP Bengard 50 WP JK Stein 50 WP Zoom 50 WP	250	500g	0.05	Effective against powdery mildew disease in ornamental plants and blast, sheath blight and sheath rot of rice
Carboxin	Vitavax 75 WP Vitavax 80 WP	1.5- 1.6 g/kg seed	--	--	For seed treatment
Ipropenphos	Kitazin- P48 EC	250	500 ml	0.05	For foliar spray against blast
Hexaco- nazole	Contaf 5 EC	25- 50	500- 1000 ml	0.005-0.01	For foliar spray against sheath blight, Brown spot, glume discoloration and sheath rot of rice
Propico- nazole	Tilt 25 EC	125	500 ml	0.025	For foliar spray against sheath blight
Potassium phospho- nate	Akomin 40%	800	2000 ml	0.16	Growth regulator effective against Phytophthora foot rot of black pepper
Tridemorph	Calixin 80 EC	400	500 ml	0.08	Coconut stem bleeding
Carpropamid	Protega 27.8 EC Arcado 27.8 EC	139	500 ml	0.028	For control of blast and sheath blight of rice
Isoprothio- lane	Fugione 40 EC	300	750 ml	0.06	For control of blast disease of rice

1	2	3		4	5
Thiophanate	Topsin 50WP Cercobin 50 WP	250	500g	0.05	For control of blast and sheath blight of rice
Thiophanate methyl	Topsin 75WP Cercobin 75 WP	375	500g	0.075	Foliar spray for control of powdery mildew in cowpea
Oxy carboxin	Plantvax 20EC	100	500 ml	0.02	Foliar spray for the control of leaf rust in coffee
Carbendazim 12% + Mancozeb 63%	Saaf 75WP	750	1000g	0.15	For control the Glume discoloration in rice, Spraying at the time of panicle emergence
Propiconazole	Tilt 25EC	125	500ml	0.025	For false smut disease control at the time of panicle emergence stage.
Trifloxystrobin 25% + Tebuconazole 50%	Nativo 75 WG	187.5	250g	0.0375	For the management of brown spot, blast, sheath blight, glume discoloration and sheath rot of rice
Tebuconazole	Folicur- 250 EC	750	300 ml	0.06	For the management of blast and sheath blight of rice
Fluzilazole	Nustar 40 EC	150	125ml	0.01	For the management of sheath blight of rice
7. Antibiotics					
Antifungal materials	Aureofungin sol 46.15% SP	-	0.005 %	0.002	For foliar spray in rice
Streptomycin	Streptomycin Sulphate 9% + Tetracycline Hydrochloride 1% SP	-	-	100-150 ppm	For foliar spray against bacterial diseases
Validamycin A 3	Validacin 3L	60		0.006	Control of sheath blight
C. HERBICIDES					
Common name	Commercial formulations and concentrations	Recommended dose kg ai/ha	Product per ha	Crops recommended	Hints on time and method of application
2,4-D sodium salt	Femoxone 80% WSP	1.0	1.0- 1.2kg	Rice- for control of broad leaved weeds and sedges	Apply at 20-25 DAS/DAT

1	2	3		4	5
2,4-D amine	Agroclor 96-58 WSL	0.8- 1.0	1.4- 1.71	Do	Do
Metsulfuron ethyl 10% + Chlorimuron ethyl 10 %	Almix 20% WP	0.004	20g	Rice	15-20 DAS/DAT
Pendimethalin	Stomp 30% EC	1- 1.50	3.3- 5.01	Rice - dry sown and vegetables	Pre-emergence spray at 0-6 DAS
Butachlor	Machete 50 EC Butachlor 50 EC	1.25	2.51	Rice-dry sown Rice-wet sown Rice- transplanted	0-6 DSA 6-9 DAS 6-9 DAT
	Machete 5 G	1.25	25 kg	Rice - wet sown and transplanted	Broadcast evenly on soil surface at 7 DAS or at 4-8 DAT
Oxyfluorfen	Goal 23.5 EC	0.15 0.1- 0.15	0.641 0.44- 0.641	Rice - dry sown Banana	0-3 DAS Pre-emergent spray
Pretilachlor	Refit 50 EC	0.50- 0.75	1.00- 1.501	Rice - dry sown	0-6 DAS
Pretilachlor + safner	Sofit 30 EC	0.45	1.50 l	Rice- wet sown	3-5 DAS
Cyhalofop butyl	Clincher 10 EC	0.08	800 ml	Rice- for control of Echinochloa spp.	Spray 18-20 DAS
Diuron	Klass 80 WP	1.00- 1.50	1.25-2.00 kg	Banana, Pineapple	Pre-emergence spray
Glyphosate	Roundup 41 SL Glycol 41 SL WeedAll 41% SL	0.82- 1.64	2.0- 4.01	Rice-land preparation Plantation crops, pineapple and banana	For clearing weeds before land preparation. Directed application in inter-row areas
Pyrazosulfuron ethyl	Sathi 10 WP	0.02-0.03	200-300 g	Rice-Wet seeded, Transplanted	6 DAS/DAT

1	2	3		4	5
Pretilachlor + Bensulfuron methyl	Londax Power (0.6 +0.06) WP	0.6 +0.06	10kg	Rice - Dry seeded Wet seeded Transplanted Pre-emergence control of all types of weeds	0-6DAS/DAT
Bispyribac sodium	Nominee gold 10SC Tarak 10 SC Adora 10 SC	0.025-0.03	250-300ml	Rice - All types of weeds except Leptochloa sp.	15-20 DAS
Carfentrazone-ethyl	Affinity 40 DF	0.02	50 g	Rice - broad leaf weeds and sedges, very effective against Melochia corchorifolia	20-25 DAT
Fenoxaprop-p-ethyl	Ricestar 6.7EC	0.06	875ml	Rice- Control of grassy weeds like Echinochloa, Sacciolepis and Leptochloa	15-18 DAS/DAT
Azimsulfuron	Segment 50 DF	0.035	70g	All types of weeds, effective against Echinochloa	15-20 DAS/DAT
Penoxsulam	Granite 24SC	0.025	104ml	All types of weeds, effective against Echinochloa spp	15-20 DAS
Ethoxy sulfuron	Sunrice 15WDG	0.015	100g	Rice - Transplanted rice Control of sedges and broad leaf weeds	15-20 DAT
Glufosinate Ammonium	Basta 15 SL	0.375-0.50	2.5- 3.3 2.5-3.3L	Non - selective contact herbicide. Rice - weedy rice control using weed Wiper: Control grasses and broad leaf weeds. Control of perennial weeds in plantations	

## Appendix 11

### DETAILS OF PESTICIDES AVAILABLE IN THE MARKET

This table is only for reference on products available in the market and should not be treated as recommended by Kerala Agricultural University. It is compiled from various sources including websites of industry and hence the product list may not be complete. Generic names included are registered by CIB & RC and their uses are approved for specific pests in certain crops (<http://cibrc.gov.in/mup.html>). But some pesticides are yet to be evaluated by KAU / other research organizations and hence all pesticides included here may not have the status "recommended by Kerala Agricultural University". For list of recommended insecticides, their doses and uses, refer Appendix 10 only.

Generic name	Strength of Formulation	Chemical Class	Colour Code (Toxicity Class)	Trade names of formulations available in the market
1	2	3	4	5
<b>A. INSECTICIDES</b>				
Abamectin	1.9EC	Avermectin	Yellow	Tagmec, Vertimec
Acephate	75 SP	Organo phosphate	Blue	Acefex, Ace, Asataf, Corochamp Dhanraj, Hilphate Lancer, Lucid, Oval Pace, Starthene Tagace, Tamaron, Torpedo
Acetamiprid	20 SP	Neonicotinoid	Yellow	Aceta, Acelon Crop pride 20 SP Dhanapreet 20 SP Ekka, Excel, Acetacel Hilpride, Lift, Manik Pride, Rekord Scuba 20 SP Star attack, Tagride
Alphamethrin	10EC	Pyrethroid	Yellow	Alfa, Guru, Alphadhan, Concord, Famex, Farsa Gem, Tata alpha Numethrin, Sherpa, Thril
Azadirachtin	1 EC	Neem based	Green	
Azadirachtin		Neem Based	Green	
Bifenthrin	10EC	Pyrethroid	Yellow	Banner, Markar, Hectastar Impecler, Talstar
Buprofezin	25 SC	Chitin Synthesis Inhibitor	Blue	Applaud, Koram, Jawaaw Flotis, Ninja, Apple, Lapa Pi Bupro, Tagvoltage

1	2	3	4	5
Carbosulfan	25EC	Carbamate	Yellow	Marshal, Aaatank
	6G	Carbamate		Sheriff, Electra
Cartap hydrochloride	4G	Nereistoxin analogue	Yellow	Stratop, Beacon GR, Caldan 4G, Cartox G, Celtap 4G Fast, Hilcartap, Kritap 4G, Kaardon
	50 SP	Nereistoxin analogue		Caldan SP, Beacon SP, Celtap 50 SP, Fast.Kritap 50 SP, Hilcartap Kaardon 50 SP, padan
Chlorantraniliprole	04G	Diamide	Green	Ferterra
	18.5SC	Diamide		Coragen
Chlorfenapyr	10SC	Chlorphenapyr	Yellow	Lepido
Chlopyrifos	10G	Organo phosphate	Yellow	Hillban 10G
	20EC	Organo		Chlorban, Classic-20 Coroban, Dhanvan, Dumet, Dursban, Hillban, Krishan, Tafaban, Radar Starban, Tagban, Tricel
	50EC	Organo phosphate		Chlorban, Dhanvan 5000 Force, Predator
Chlothianidin	50WDG	Neonicotinoid	Green	Dantop
Cypermethrin	10EC	Pyrethroid	Yellow	Shakthi 10, Starcip 10 Challenger, Cyprerol Bang X 505, Superkiller Kricyp 10, Ralo 10 Ustaad
	25EC	Pyrethroid		Starcip 25, Shakthi 25 Challenger, Kricyp 25 Cypercel, Superkiller Crop cyper, Colt, CyruX Tata Cyper
Deltamethrin	11 EC	Pyrethroid	Yellow	Tagcis
	2.8 EC	Pyrethroid		Decis
Diafenthiuron	50 WP	Insect growth regulator	Blue	Polo, Pegasus
Dichlorovos	76EC	OP	Yellow	Fume, Divap, Doom, Hilvos Luvon-76, Starchlor Divipan, Nuvan, Vapona



1	2	3	4	5
Dicofol	18.5EC	Dicofol	Blue	Tag fol, Klin, Tiktoc, Hilfol Starkel
Diflubenzuron	25WP	Chitin synthesis inhibitor	Green	Dimilin
Dimethoate	30EC	Organo phosphate	Yellow	Tara 909, Rogor, Tagor, Nugor
Dinocap	48EC		Blue	Karilex
Emamectin benzoate	5SG	Avermectin	Yellow	EM-1, Proclaim, Robot Starclaim, Prabhaav, Spolit
Ethion	35EC	Organo phosphate	Yellow	Tafethion
	50EC	Organo phosphate		Tafethion, Hera, Mit 505 Mitkil, Promite, Mithiyon Anumit-50, Novathion Dhamunit, Fosmite, Krithion, Mit 505, Hilmite
Ethofenoprox	10EC	Pyrethroid	Yellow	Trebon, Nukil
Fenazaquin	10EC		Yellow	Magister
Fenpropathrin	30EC	Pyrethroid	Yellow	Mighty
Fenpyroximate	5EC		Yellow	Pyromite, Mite Block Sedna, Mitigate
Fenobucarb	50EC	Carbamates	Yellow	Blast, Knock
Fenvalerate	20EC	Pyrethroid	Yellow	Tatafen, Tagfen, Fencen Fenval, Fighter EC, Yesfen Anufen, Fencro, Newfen Marsfen, Lufen, Fenkil Krifen, Arfen DP, Agrofen 20 EC, Fengun
	0.4DP			Fenkil, Arfen, Power Agrofen, Fighter
	2D			Fengun Fencel Dust
Fipronil	0.3GR	Fiprole	Yellow	Regent, Corofip GR, Tag Agent GR, Mahaveer GRAgadi G, Stargazette SC Fax GR, Ferodan GR Fipro plus GR
	80WG	Fiprole		Jump
	5SC	Fiprole		Regent, Rabid, Fax SC, Fipro plus, Ferodan SC Stargazette SC, Refree Corofip SC, TagAgent SC

1	2	3	4	5
Flonicamide	50WG	Flonicamide	Blue	Ulala
Flubendiamide	20WG	Diamide	Green	Takumi, Fluton
	39.35SC	Diamide		Fame, FM - 480, Leako Fluid
Imidacloprid	17.8SL	Neonicotinoid	Yellow	Crop mida, Agro mida Tata mida, Sensex, Confidor JK Imida, Seamer, Courage Maharaja, Shogun, Mantra Novastar, Imigro, Nagarjuna mida, Hillmida, Atom Imidacel, Imida Gold Anumida, Confident, Dharbhar, Admit, Josh/Guard Parrymida, Suzu, Jumbo Imidastar, Imidan, MediaVictor, Tropical Magik
	30.5SC	Neonicotinoid		Tropical Magik Super Avenger, Josh/Guard Mex/ Intrex, Rex
	70WS	Neonicotinoid		Imigro, Gaucho, Hillmida, Protect
	70 WG	Neonicotinoid		Tagmyre, Dzire, Apache R Bullet, Chemida, Cohigan Royal, Admire
	48FS	Neonicotinoid		Imigo 600FS, Imigro FS
Indoxacarb	14.5SC	Oxadiazine	Yellow	Avaunt, Tag Power, Fego Challenger, Inlay, Sarvada King Doxa, Heroxa JK Indoxa, Doxagan
	15.8 EC	Oxadiazine		Avaunt, Fego, PI Indox Dhawa Gold
Lambda cyhalothrin	4.9CS	Pyrethroid	Yellow	Matador
	2.5EC	Pyrethroid		Ninja-R, Santri, Lambda 2.5 Samurai Tag Demand Kabaddi, Lambda Star Veera Marsjudo, Lancer Lamdex, agent, Excel Glow Constant, Reeva, Kunfu
	5EC	Pyrethroid		Reeva 5, Cyclo-50/Tanja-50 Jayam, Santri, Samurai Wrestler; Coro lambda Judho, super glow, Instant Agent Plus, Excel Glow Hill lambda, Tag Command Lamdex Super, Karate Ninja-V, Agent Plus Balraj, Devashakti

1	2	3	4	5
Lufenuron	54EC	CSI	Green	Signa
Malathion	5DP	OP	Blue	Malathion DP, Marsthion
	50EC	OP		Agromala, Thisol, Agromala Malathion, Simala Milthion, Kthion, Hilmala, Malaacid, Tagthion Malamar, Celthion
Metaflumizone	22SC	Metaflumizone	Blue	Tagline, Versimo
Metaldehyde	2.5DP	Acetaldehyde polymer	Yellow	Snailkill
Novaluron	10EC	CSI	Green	Rimon, Nova, Rimostar Pedestal
	8.8SC	CSI		Pedestal Supra
Permethrin	25EC	pyrethroids	Yellow	Perkill, signor, Tagbush Ambush, Permasect
Phenthoate	50EC	OP	Yellow	Dhnusan, tagsan
Phosalone	35 EC	OP	Yellow	
Propargite	57EC	propargite	Yellow	Mitza, Simbaa, Acarit
Pyrdalyl	10EC	Pyrdalyl 2	Blue	Leo
Quinalphos	25EC	OP	Yellow	Anuphos, Quincid Starlux, Agroquin, Hilquin Geelux, Guin Guard Tagquin, Rambalux Quinolux, H.LX, Kinalux Exalux, Kilux, quinaswan Flash
	1.5DP	OP		Marsquin, Quincid, Kinalux
Quinalphos	5GR	OP	Yellow	Kinalux
Spinosad	45SC	Spinosyn	Blue	Tracer, Champion, Spintor Tagsulf
	2.5SC	Spinosyn		Success, Champion, Tagsulf
Spiromesifen	22.9SC	Tetronic and tetranic acid derivative	Blue	Voltage
Thiacloprid	21.7SC	Neonicotinoid	Yellow	Alanto, Tagsulf
Thiodicarb	75WP	Carbamate	Yellow	Larvin, Tagton, Tomado, Ajx Chekk, Spiro
Thimethoxam	25WG	Neonicotinoid	Blue	Click, Tagsulf, Slayer, Krioxam, Maxima, ACT 150 Tagxone, Actara, Theme Suckgan, Renova, Wonderex, Exam
	70 WS	Neonicotinoid		Crusier
	30FS	Neonicotinoid		Tagton

1	2	3	4	5
<b>B. COMBINATION PRODUCTS OF INSECTICIDES</b>				
Acephate+ Imidacloprid	50+1.8WP	OP+ Neonicotinoid	Blue	Stargold
Acephate 25EC+ Fenvalerate 3EC	25EC+3EC		Yellow	Devine
Buprofezin 5.65% & Deltamethrin 0.72% EC	5.65%+ 0.72EC	CSI + Pyrethroid	Yellow	Dadeci
Chlorpyrifos 16+ Alphacyperme- thrin 1 EC	16EC+1EC	OP + pyrethroid	Yellow	Alert
Chlorpyrifos	50EC+5EC 50 + Cypeme- thrin 5EC	OP + Pyrethroid	Yellow	Action 505 Herasakthi, Anth Cannon, Double Star, Super D, Hillhunter Koranda 505, Cyklon Synargy, Nurocomb Nuvella D 505
Cypermethrin 3% Quinolphos 20% EC	3EC+20EC	Pyrethroid + OP	Yellow	Virat
Ethion 40% + Cypermethrin	40EC +5EC  5% EC	OP + Pyrethroid	Yellow	Nagata, Mit Plus Ananda, Dragon Cyperton, Spectrum D, Colfos
Ethiprole 40% + Imidacloprid 40% WG	40WG + 40WG		Yellow	Glamore
Indoxocarb 14.5 + Acetamiprid 7.7 SC	14.5 SC + 7.7 SC	Oxadiazene + Nicotenoid	Yellow	Caesar
<b>C. FUNGICIDES</b>				
Azoxystrobin	23% SC	Strobilurins	Green	Amistar, Heritage, Mirador, Abound
Benomyl	50% WP	Benzimidazole	Green	Benefit, Cure, Cure 500,
Bitertanol	25% WP	Triazoles	Blue	Baycor
Captan	50% WP	Phthalamides	Green	Dhanutan 50% WP, Captaf, Captan
	75% SP	Phthalamides		Delton, Hexacalt, Dhanuban
Carbendazim	25% WP	Benzimidazole	Green	B - Stin
	46.27% SC	Benzimidazole		Batista, Perl, Nakshathra, Fungiguard

1	2	3	4	5
	50% WG	Benzimidazole	Green	Derosul
	50% WP	Benzimidazole		Fungiguard, Benmain, Bensaana, Dhanustin 50% WP Gancarzin 50, Tagstin, Benlate, Bavistin, Benfil, Bengard, Carben, Carziim 50, Dhanustin, Glizim Mintho, Tiara, Zoom
Carboxin	75% WP	Carboxanilide	Blue	Vitavax
Carpropamid	27.8% SC	Cyclopropane carboxamide	Green	Protega, Arcado
Chlorothalonil	75% WP	Chloronitrile	Blue	Odeon, Kavach 75 WP, Ishaan, Cluch 70WP
Copper Hydroxide	77% WP	Inorganic copper	Blue	HiDice, Kocide 101
Copper Oxychloride	20% EC	Inorganic copper	Blue	Cutox
	50% WP	Inorganic copper		Killex copper, Star cop, Maincop Dhanucop, Fytox, Bluetrox, Fytran Fytolan, Bensaana, Blitox, Blue copper, Trucop, Cupramar, Cuprina, Copter, Dhanucop, Fytolan, Hilcopper, Tagcop
	56% ODP	Inorganic copper		Fytox & Bluetrox, COC - ODP 56%
	56% WP	Inorganic copper		Tagcop
Copper sulphate		Inorganic copper	Blue	Blue Sea's, TCF Brand, Copper Blues
Cyazofamid	34.5 % SC	Cyanoimidazole	Blue	Ranman
Cymoxanil	50% WP	Acetamide	Blue	Curzate
Difenoconazole	25% EC	Triazole	Blue	Score 25 EC
Dimethomorph	50% WP	Morpholine	Blue	Oo - main, Lurit, Promcel
Dinocap	48% EC	Dinitrofungicide	Blue	Arathane, Karathane
Dodine	65% WP	Substituted acetate	Blue	Noor
Fenarimol	12% EC	Pyrimidines	Blue	Rubigan
Flusilazole	40% EC	Triazole	Blue	Cursor, Nustar
Fosetyl - Al	80% WP	Ethyl phosphonate	Green	Aliette

1	2	3	4	5
Hexaconazole	2% SC	Triazole	Blue	Samarth
	5% EC	Triazole		Topper, Topper plus EC, Mainex EC, Xantho, Hexan, Hexadhan, Hexacone, Force 5C, Hexaan, Alert Creeper, Contaf, Corazole, Hexadhan, Danzole, Hexazole, Hexacone, Hexamax, Sitara, Strike, Titan
	5% SC	Triazole		Xantho Premium, Hexan white, Hexadhan plus, Force plus 5, Hexaan white, Contaf Plus, Danzole Plus, Remo, Fowmox, Hexazole Gold, Nagajuna Mass+, Sitara plus
Iprodione	50% WP	Dicarboxamide	Blue	Rovral
Isoprothiolane	40% EC	Dithiolane	Blue	Isomain, Rhizo, Fuji-One 40E
Kresoxim methyl	44.3% SC	Strobilurin	Green	Ergon
Lime Sulphur	22% SC	Inorganic Sulphur	Green	Lime sulfur solution
Mancozeb	35% SC	Ethylene bis dithiocarbamate		Safety, Hydroman
	75% SP	Ethylene bis dithiocarbamate		Mancoban
	75% WG	Ethylene bis dithiocarbamate		Mafil
	75% WP	Ethylene bis dithiocarbamate	Green	Macoban, Macoban M - 45, Mancosaan, Dhanuka M 45, M - Guard, Zinthane, Izeb M- 45 Manzate, Hindustan M 45 Devidayal M - 45, Mancosaan M - 45, Dithane M - 45, Tata M-45 Eurofil - NT, Dhanuka M- 45, Dithane, Hilthane, Indofil M 45, Savour M-45, Luzen - 45, Maneb Manzane, Uthane M- 45, Veera
Mandipropamid	23.4% SC	Mandelamide	Blue	Revus

1	2	3	4	5
Metalaxyl	35% WS	Acylalanine	Blue	Bilaxyl, Metal -D, Tagron, Galaxy PC Metals,
	8% WS	Acylalanine		Metal
Myclobutanil	10% WP	Triazole	Blue	Myclomain, Mycobil, Systhane, Boon, Mycoguard, Index
Penconazole	10% EC	Triazole	Blue	Topas
Pencycuron	22.9% SC	Triazole	Blue	Monceren
Potassium phosphonate	40%	Phenyl Urea	Green	Akomin
Propiconazole	14.3% EC	Triazole	Blue	Banner
	25% EC			Bumper, Zetox, Propiguard, Tilt, Albu, Radar, Tilt, Dhan, Propik Final, Result, Pinade
Propineb	70% WP	Propalane bis dithiocarbamate	Blue	Proximain, Addit, Sanipeb, Propinex
Pyraclostrobin	20 EC	Strobilurin	Blue	Insignia
Sulphur	40% SC	Inorganic sulphur	Green	Super Sonic SC
	55.16% SC	Inorganic sulphur		Nansulf flow
	80% DP	Inorganic sulphur		Five star
	80% WDG	Inorganic sulphur		Mainsul, Sulfoguard, Microsul WDG, Villo, Dhanusul, Koshavet 80 WDG, Cosavet, Nanthiin DF Sulfexgold, Sulfil
	80% WP	Inorganic sulphur		Wettasul, Dhanusul 80% WP Ganesulf, Tagsulf, Sulfix 80 WP Sulfex 80, Microsul, Thiovit, Dhanusul, Insulf, Sulfex
85% DP	Inorganic sulphur		Dhanusul 85% DP	
Tebuconazole	2% DS	Triazole	Blue	
	25.9% EC	Triazole		Orius, Folicur, Tebustar
	24% SC	Triazole		Vista, Spencer
Thiophanate Methyl	70% WP	Thiourea	Blue	Maxim, Topmast, Upaay, Roko

1	2	3	4	5
Thiram	75% WS	Dithiocarbamate	Blue	Tagithram, Thiride, Vegfru Thiram, Thiram 75% DS, Hexathir
Thiifluzamide	24% SC	Carboxinilides	Blue	Pulser
Triacontanol	GR 0.5% M		Blue	Speed -up
Triadimefon	25% WP	Triazole	Blue	Bayelton
Triacontanol	EW 01.5 MIN	Saturated primary alcohols	Green	Vishal, Ureka
Tridemorph	80% EC	Morpholenes	Blue	Calixin
Ziram	27% SC	Dimethyl Dithiocarbamate	Blue	Dhanuka Z- 27
	80% WP	Dimethyl Dithiocarbamate		Ziride, Vegfru Zitox, Hexazir
D. COMBINATION FUNGICIDES				
Captan 70% + Hexaconazole 5% WP	70 WP + 5 WP	Chlorinated nitrobenzene + Triazole	Blue	Panther Gold, Takatvar Taquat
Carbendazim 12% + Mancozeb 63% WP	12 WP + 63 WP	Benzimidazole + Dithiocarbamate	Green	Kuber, Macoban, Macoban C Trophy, Sixer, Revive 750, Hi - Jip, Stuff, companion, Dasma, Nagarjuna Combi+, Riper, Saaf, Sprint, Merger
Carbendazim 25% + Flusilazole 12.5% SE	25 SE + 12.5 SE	Benzimidazole + Triazole	Blue	Lustre
Carboxin 17.5% + Thiram 17.5% FF	17.5 FF + 17.5 FF	Carboxanilide + Dithiocarbamate	Blue	Vitavax Ultra 200 FF
Carboxin 37.5% + Thiram 37.5% WP	37.5 WP + 37.5 WP	Carboxanilide + Dithiocarbamate	Blue	Vitavax powder, Trooper
Cymoxanil 8% + Mancozeb 64% WP	8 WP + 64% WP	Acetamide + Dithiocarbamate	Blue	Cymagan, Qurate Gold, Curzate, Moximate
Dimethomorph 9 WP + Mancozeb 60 WP	9 WP + 60 WP	Cinnamic acid-morpholine derivative + Dithiocarbamate	Blue	Acrobat MZ



1	2	3	4	5
Famoxadone 16.6%+ Cymoxanil 22.1%SC	16.6SC + 22.1SC	Cinnamic acid amides + Acetamide	Blue	Equation Pro
Fenamidone 4.44%+ Fosetyl AL 66.7%WG	4.44WG + 66.7WG	Imidazolinone +Ethyl Phosphonate	Blue	Verita
Iprodione 25% + Carbendazim 25%WP	25 WP + 25 WP	Dicarboxamide +Benzimidazole	Blue	Quintal, Double dose
Mancozeb 64% WP + Metalaxyl 8%WP	64 WP + 8 WP	Dithiocarbamate + Acylalanine	Blue	Syscon
Metalaxyl 8% + Mancozeb 64% WP	8 +64 WP	Acylalanine + Dithiocarbamate	Blue	Master, Duet, Kirlaxyl MZ 72 Matco 864, Metal Man Metal Plus, Metallic Mix Syscon, Unilax, Redomil MZ 78
Metalaxyl 8% WP + Mancozeb 72% WP	8WP +72 WP	Acylalanine + Dithiocarbamate	Blue	Tagmill
Pyraclostrobin 5% +Metiram 55% WG	5 +55 WP	Strobilurin + Dithiocarbamate	Blue	Clutch
Streptomycin sulphate + Tetracycline hydrochloride 90.10 SP	90 +10 WP	Streptomycin sulphate + Tetracycline hydrochloride	Blue	Tagmycin
Trifloxystrobin 25% + Tebuconazole 55%WG	25 WP +55WG	Strobilurins + Triazole	Blue	Nativo

## E. ANTIBIOTICS

Aureofungin	46% SP	Aureofungin Sol
Kasugamycin	3% SL	Kasu B, Pollen
Validamycin	3% L	Valigan

1	2	3	4	5
F. HERBICIDES				
2,4-D amine	58WSL	Phenoxy acids	Yellow	Agrodar 96, Advance
2,4-D ethyl ester	35EC	Phenoxy acids	Yellow	Weedar; Ethyl ester; Agrodon
2,4-D sodium salt	80WP	Phenoxy acids	Yellow	Weedar; Weed clean Femoxone, Knock weed
Bensulfuron methyl	60DF	Sulfonyl ureas	Blue	Rozal, Escuri
Bispyribac sodium	10SC	Pyrimidinyl (thio) benzoate	Blue	Nomineegold, Taarak, Adora
Butachlor	5G, 50EC	Amides	Blue	Machete, Fastmix, Superchlo, Dhanuclor; Nimul, Hiltachlor; Madhuchlor; Thunder; Butalax, Weedkil, Jaichlor; Butachlor
Chlorimuron ethyl	25WP	Sulfonyl ureas	Blue	Classic
Cyhalofop butyl	10EC	Aryloxy phenoxy-propionate	Green	Clincher
Diuron	80WP	Ureas	Blue	Klass, Dynamite
Ethoxy-sulfuron	15WDG	Sulfonyl ureas	Blue	Sunrise
Fenoxaprop-p-ethyl	10EC	Aryloxy	Blue	Puma super;
	9.3EC	phenoxy		Whip super;
	6.7EC	propionate		Rice star
Glufosinate ammonium	13.5SL	Phosphonic acid	Blue	Basta, challenge
Glyphosate	41 SL	organo-phosphorus	Blue	Glytaf, Roundup, Noweed, Glycel, Cleanup, Glyfos, sweep, Jaicell, WeedAll, Safal
Metsulfuron methyl	20WP	Sulfonyl ureas	Blue	Algrip, Ally, Allie, Gropper; Escort
Oxadiargyl	80WP	Oxadiazole	Blue	Topstar
	6 EC			Raft

1	2	3	4	5
Oxyfluorofen	23.5EC	Diphenyl ether	Blue	Oxy Gold, Goal
Pendimethalin	30EC	Dinitroanilines	Blue	Stomp, Dhanuslone, Tata panida
Pretilachlor	50EC,	Chloroacetamide	Blue	Pretty herb, Refit
Pretilachlor + Safener	30.7EC		Blue	Preet, Taghit
	30EC	Chloroacetamide		Sofit
Pyrazosulfuron	10WP	Sulfonyl ureas	Blue	Sathi
G. COMBINATION PRODUCTS OF HERBICIDES				
Bensulfuron methyl + Pretilachlor	0.6+6G	Sulfonyl ureas	Green	Londax Power
Metsulfuron+ Chlorimuron	20WP	Sulfonyl ureas	Blue	Almix, Synmuron,

Yellow

Blue

Green



Highly toxic



Moderately toxic



Slightly toxic

Formulations :- CS - Colloidal Suspension; DP - Dusting Powder; DS - Dispersible Solid; EC - Emulsifiable Concentrate; FS - Flowable suspension; G/GR - Granule; SC - Suspension Concentrate; SG - Soluble Granule; SL - Soluble Liquid; SP - Soluble Powder; WG - Wettable Granule; WP - Wettable powder; WS - Water Soluble; WDG - Water Dispersible Granule; WSP - Water Soluble Powder.

## Appendix 12

## LIST OF PESTICIDES/ PESTICIDE FORMULATIONS BANNED IN INDIA

## A. Pesticides banned for manufacture, import and use (28 Nos.)

Sl. No.	Name of pesticides	Sl. No.	Name of pesticides
1	Aldrin	15	Pentachlorophenol
2	Benzene Hexachloride	16	Phenyl Mercury Acetate
3	Calcium Cyanide	17	Sodium Methane Arsonate
4	Chlordane	18	Tetradifon
5	Copper Acetoarsenite	19	Toxafen
6	Dibromochloropropane	20	Aldicarb
7	Endrin	21	Chlorobenzilate
8	Ethyl Mercury Chloride	22	Dieldrine
9	Ethyl Parathion	23	Maleic Hydrazide
10	Heptachlor	24	Ethylene Dibromide
11	Menazone	25	TCA (Trichloro acetic acid)
12	Nitrofen	26	Metoxuron
13	Paraquat Dimethyl Sulphate	27	Chlorofenvinphos
14	Pentachloro Nitrobenzene	28	Lindane*

\* Banned vide Gazette Notification No S.O. 637(E) Dated 25/03/2011)-Banned for Manufacture, Import or Formulate w.e.f. 25<sup>th</sup> March,2011 and banned for use w.e.f. 25<sup>th</sup> March, 2013.

## B. Pesticide / Pesticide formulations banned for use but their manufacture is allowed for export (2 Nos.)

Sl.No.	Name of pesticides
29	Nicotin Sulfate
30	Captafol 80 Powder

## C. Pesticide formulations banned for import, manufacture and use (4 Nos.)

Sl.No.	Name of pesticides
1	Methomyl 24 L
2	Methomyl 12.5 L
3	Phosphamidon 85 SL
4	Carbofuran 50 SP

## D. Pesticides withdrawn (7 Nos.)

Sl.No.	Name of pesticides
1	Dalapon
2	Ferbam
3	Formothion
4	Nickel Chloride
5	Paradichlorobenzene (PDCB)
6	Simazine
7	Warfarin

## E. Pesticides refused registration

Sl.No.	Name of pesticides
1	Calcium Arsonate
2	EPM
3	Azinphos Methyl
4	Lead Arsonate
5	Mevinphos (Phosdrin)
6	2,4, 5-T
7	Carbophenothion
8	Vamidothion
9	Mephosfolan
10	Azinphos Ethyl
11	Binapacryl
12	Dicrotophos
13	Thiodemeton / Disulfoton
14	Fentin Acetate
15	Fentin Hydroxide
16	Chinomethionate (Morestan)
17	Ammonium Sulphamate
18	Leptophos (Phosvel)

## F. Pesticides restricted for use in India

Sl.No.	Name of pesticides	Type of Restriction
1	Aluminium Phosphide	3g tablets in cage packing and powder form in pouch allowed for use in rat burrows
2	DDT	Banned in agriculture; Restricted use allowed only for domestic public health program upto 10,000 MT per year
3	Lindane	Restricted use allowed only in termite control upto 24-03-2013
4	Methyl Bromide	To be used only by Govt. under strict supervision of Govt Expert or pest control operator
5	Methyl Parathion	Restricted use allowed only on crops where honeybees are not acting as pollinators
6	Sodium Cyanide	Only for fumigation of cotton bales by Plant Protection Adviser to Govt. of India under expert supervision
7	Methoxy Ethyl Mercuric Chloride (MEMC)	Only for seed treatment of potato and sugarcane
8	Monocrotophos	Banned in vegetables
9	Endosulfan	Banned in Kerala State
10	Fenitrothion	Banned in agriculture except for locust control and in public health
11	Diazinon	Banned in agriculture except for household pest control
12	Fenthion	Banned in agriculture except for locust control, household pest control and public health
13	Dazomet	Banned in tea.

Source: [http://cibrc.gov.in/list\\_pest\\_bann.htm](http://cibrc.gov.in/list_pest_bann.htm)

## Appendix 13

## Ad hoc recommendations for the management of pests and diseases in selected crops

Sl. No.	Crop	Pests	Ad hoc recommendation
1.	Banana	Pseudostem weevil	Apply Fipronil 5% SC 0.015% (3ml l <sup>-1</sup> ) or Carbosulfan 25 EC 0.038% (1.5ml l <sup>-1</sup> ) at 5, 6, and 7 months after planting In organic farming apply Beauveria bassiana @ 20 g l <sup>-1</sup> at 5, 6 and 7 months after planting
		Rhizome weevil	Apply Thiamethoxam 25 WG @ 0.2gl <sup>-1</sup> or 1 g per 5 litres at planting followed by two applications, 2 and 5 months after planting or Fipronil 0.3G @ 10g formulation/plant at planting followed by two applications, 2 and 5 months after planting. Sucker treatment with Pseudomonas fluorescens @ 20gl <sup>-1</sup> + application of entomopathogenic nematode, Heterorhabditis bacteriophora @ 4 infected wax moth larvae/plant at planting followed by two applications, 2 and 5 months after planting
		Root knot (reniform and burrowing) nematodes	Carbosulfan 6G @ 16.7kg ha <sup>-1</sup>
Sl. No.	Crop	Diseases	Ad hoc recommendation
1.	Coconut	Leaf rot	After crown cleaning (removal and destruction of affected parts) in coconut palms pour 300 ml of fungicide solution containing hexaconazole- 2 ml +potassium phosphonate- 4ml at the base of spear leaves twice a year (April-May and September-November).
2.	Pepper	Foot rot	As alternate chemicals, copper hydroxide @ 2 g l <sup>-1</sup> and cenamidon (10%) + mancozeb (50%) @ 2 g l <sup>-1</sup>
3.	Banana	SigatoKa leaf spot	Spraying Azoxystrobin 1ml l <sup>-1</sup> or Tebuconazole 1ml l <sup>-1</sup> or Difenconazole 1ml l <sup>-1</sup>
4. a.	Vegetables Amaranth	Leaf blight	Two sprays of copper hydroxide @ 1.5 g l <sup>-1</sup> at 14 days interval for seed purpose

Sl. No.	Crop	Diseases	Ad hoc recommendation
b.	Bittergourd	Powdery mildew	Foliar spray with Wettable Sulphur 2 g l <sup>-1</sup> thrice at 14 days interval or foliar spray with Tebuconazole 1 ml l <sup>-1</sup> twice at 14 days interval.
		Downy mildew	Spraying pyraclostrobin @ 0.5 g l <sup>-1</sup>
c.	Bhindi	Cercospora leaf spot	Spraying of Tebuconazole - 1.5 ml l <sup>-1</sup> at fortnightly interval after the appearance of the symptoms.
d.	Cowpea	Fusarium wilt	Soil drenching of Flusilazole 1 ml l <sup>-1</sup> or Hexaconazole 2 ml l <sup>-1</sup> or combination fungicide Carbendazim and Mancozeb 2 g l <sup>-1</sup> at 20 and 40 DAS.
		Root rot and web blight	Flusilazole 1 ml l <sup>-1</sup> as soil drenching 20 and 40 days after sowing or combination fungicide Carbendazim and Mancozeb seed treatment 2g kg <sup>-1</sup> seed + soil drenching 2 g l <sup>-1</sup> 20 and 40 DAS
		Collarrot	Combination fungicide of Carbendazim and Mancozeb as seed treatment @ 2 g kg <sup>-1</sup> and soil drenching @ 2 g l <sup>-1</sup> soil drenching at 20 and 40 DAS.
e.	Ginger	Rhizome rot and Fusarium yellow	Rhizome treatment with carbendazim + mancozeb (2 g l <sup>-1</sup> ) for 30 min + drenching of carbendazim + mancozeb (2g l <sup>-1</sup> ) -2 MAP, 4 MAP.



## Appendix 14

### AD HOC RECOMMENDATIONS FOR MANAGEMENT OF SECONDARY AND MICRO NUTRIENTS

#### A. CROP-WISE RECOMMENDATIONS:

##### 1. Rice

###### Preventive strategies for Zn management

- Presoak seeds in a 2% ZnSO<sub>4</sub> suspension in water (20 g ZnSO<sub>4</sub> per litre). 1kg seed to be presoaked in 1 litre of ZnSO<sub>4</sub> suspension for 24 hours, drain and keep for sprouting.
- Fertilizer management: Apply sufficient quantity of organic manure. Incorporate 20 kg Zn sulfate per ha in the soil before seeding or transplanting.

###### Treatment of Zn deficiency

If Zn deficiency symptoms are observed in the field, apply 20 kg ZnSO<sub>4</sub>·7 H<sub>2</sub>O per ha.

Foliar spray of 0.5% ZnSO<sub>4</sub> solution, (1kg ZnSO<sub>4</sub> + 1/2kg lime to avoid phytotoxicity in 200 L water ha<sup>-1</sup> ie. 5 g ZnSO<sub>4</sub> + 2.5 g lime per litre of water) for emergency treatment of Zn deficiency in growing plants. Apply at tillering (25–30 DAT) and give two or three repeat applications at intervals of 10–14 days.

Application of magnesium as basal dose @ 20 kg MgO/ha is effective in giving significant increase in grain and straw yield of rice in magnesium deficient soils.

##### 2. Coconut

Magnesium sulphate @ 0.5-1.0 kg/palm/year is recommended for root (wilt) affected area.

For sandy and sandy loams of Onattukara and similar situations and also for hybrid palms grown in root (wilt) affected areas, apply 500 g MgSO<sub>4</sub>/palm/year.

Apply lime or dolomite during April-May, magnesium sulphate during August- September and organic matter during May – June. For an adult palm 1 kg dolomite or 1 kg lime + 0.5 kg MgSO<sub>4</sub> is required per annum.

##### 3. Arecanut

Magnesium sulphate @ 60 g, borax and zinc sulphate @ 20 g per palm/year can be recommended for yellowing affected palms.

#### 4. Banana

Banana micromix : This mixture is formulated using fertilizer grade Ferrous Sulphate, Manganese Sulphate, Zinc Sulphate, Borax and Copper Sulphate

Composition of mixture formulation for 1 ha

FeSO <sub>4</sub>	¼ kg ha <sup>-1</sup>
MnSO <sub>4</sub>	½ kg ha <sup>-1</sup>
ZnSO <sub>4</sub>	2 kg ha <sup>-1</sup>
Borax	7 kg ha <sup>-1</sup>
Copper sulphate	¼ kg ha <sup>-1</sup>
Total	10 kg ha <sup>-1</sup>

Composition of 100 kg of mixture formulation

Carrier	Quantity
FeSO <sub>4</sub>	2.5 kg
MnSO <sub>4</sub>	5 kg
ZnSO <sub>4</sub>	20 kg
Borax	70 kg
Copper sulphate	2.5 kg

Dose - 10 kg ha<sup>-1</sup> or 4 g/plant

Mode of application - Soil/foliar

Time of application

1. Soil - Along with the 2<sup>nd</sup> split dose of NPK
2. Foliar - 3 months after planting as 1% spray by dissolving 4 g mixture in 400 ml water / plant

Nutrients available in the mixture

Fe	-	1 %
Mn	-	2 %
Zn	-	4 %
B	-	6%
Cu	-	1 %

Shelf life - three months

#### 5. Ginger and Turmeric

Boron @ 2 kg ha<sup>-1</sup> and Zinc sulphate @ 30 kg ha<sup>-1</sup> can be used in deficient soils.

## 6. Groundnut

Application of S and B @ 20 kg and 4 kg ha<sup>-1</sup> respectively can be recommended.

## 7. Cowpea

Lime @ 250 kg ha<sup>-1</sup> or dolomite @ 400 kg ha<sup>-1</sup> can be recommended at the time of first ploughing.

## 8. Cocoa

Dolomite @ 100 g/plant/year to plants from the third year onwards.

In case of zinc deficiency, spray 0.5 to 1.5 % ZnSO<sub>4</sub> three times a year.

## 9. Sesamum

Sulphur @ 30 kg ha<sup>-1</sup> and boron @ 2.5 kg ha<sup>-1</sup> is can be recommended for sesame in rice fallows of Onattukara.

Apply ZnSO<sub>4</sub> 20 kg ha<sup>-1</sup> in the loamy/ sandy soils of Onattukara region in case of deficiency.

## 10. Black Pepper

When Soil pH < 5.5 – apply lime @ 500 g / standard, in alternate years. Use Dolomite if Mg is also low. Apply 200 g Mg SO<sub>4</sub> per vine when there is Mg deficiency. In a zinc deficient soil, apply zinc sulphate @ 30 g per vine (30 kg ha<sup>-1</sup> ZnSO<sub>4</sub>) or give foliar spray of 0.5% Zinc sulphate twice at new flushing and spike initialization stage. In case B deficiency, apply Borax @ 10 to 20 g/standard or give foliar spray of 0.2% borax. When there is Mo deficiency apply sodium molybdate @ 1 kg ha<sup>-1</sup> or give foliar spray @ 0.1%.

## 11. Cardamom

In zinc deficient soils, apply zinc sulphate @ 25 kg ha<sup>-1</sup> or give foliar spray of 0.25% Zinc sulphate twice at flushing and panicle initialization stage. Apply Borax @ 7.5 kg ha<sup>-1</sup> in B deficient soils or give foliar spray of 0.2% borax.

## 12. Tomato

Soil application @ 10 kg ZnSO<sub>4</sub> ha<sup>-1</sup> and 2 kg B ha<sup>-1</sup> is recommended for tomato.

## 13. Rubber

In case of magnesium deficiency symptoms use 50 kg of commercial magnesium sulphate per hectare.

## 14. Cassava

In case of deficiency, use MgSO<sub>4</sub> @ 20 kg ha<sup>-1</sup> and ZnSO<sub>4</sub> @ 10 kg ha<sup>-1</sup>, S @ 50 kg ha<sup>-1</sup> S and B as borax @ 10 kg ha<sup>-1</sup>.

## 15. Sweet potato

In case of Boron deficiency use borax @ 1.5 kg ha<sup>-1</sup>.

## B. SOIL BASED RECOMMENDATIONS:

In cases where crop-specific recommendations are not available, the following guidelines can be used for recommending secondary and micro nutrients.

### Secondary Nutrients (Ca, Mg, S)

Calcium deficiency can be anticipated in extremely acidic, highly leached tropical soils. If the exchangeable Ca level is less than 300 mg kg<sup>-1</sup>, soils are classified as deficient. Lime application at rates given below is recommended.

Sl. No.	pH range	Class	Lime requirement (Kg CaCO <sub>3</sub> ha <sup>-1</sup> )
1	<3.5	Ultra acid	1000
2	3.5 - 4.5	Extremely acid	850
3	4.5 - 5.0	Very Strongly acid	600
4	5.0 - 5.5	Strongly acid	350
5	5.5 - 6.0	Moderately acid	250
6	6.0 - 6.5	Slightly acid	100

Magnesium deficiency can also be observed under extremely acidic soil environment. If the exchangeable Mg level is less than 120 mg kg<sup>-1</sup>, soils are classified as deficient. Application of MgSO<sub>4</sub> @ 80 kg ha<sup>-1</sup> is recommended.

Highly leached tropical soils may develop S deficiency. When available sulphur levels in soil are less than 5 mg kg<sup>-1</sup>, symptoms may appear. Application of sulphur/ sulphur containing fertilizers to give 25kg S per hectare is recommended.

### Micro nutrients (Fe, Mn, Cu, Zn and B)

Kerala soils in general have high levels of iron and manganese. Toxic soluble levels of these elements can be managed by liming. Deficiency situation may arise in sandy soils with neutral/alkaline reaction. When the available Fe is less than 5 mg kg<sup>-1</sup> the soil is considered as deficient. Application of FeSO<sub>4</sub> @ 15 kg ha<sup>-1</sup> is recommended. Available Mn level less than 1 mg kg<sup>-1</sup> soil condition is rated as deficient. Foliar application of 0.5% MnSO<sub>4</sub> is recommended.

Copper deficiency is observed in 31% of soils in Kerala. Available Cu level below 0.12 mg kg<sup>-1</sup> in neutral/alkaline soils and below 1 mg kg<sup>-1</sup> in acid soils is rated as deficient. Application of CuSO<sub>4</sub>·5H<sub>2</sub>O @ 2 kg ha<sup>-1</sup>, seedling dip in 1% copper sulphate solution or soaking of seeds in 0.25% copper sulphate solution for rice is recommended.

Deficiency of Zn is observed in about 34% soils in Kerala. Available Zn less than 0.6 mg kg<sup>-1</sup> in neutral/alkaline soils and 1 mg kg<sup>-1</sup> in acid soils is rated as deficient condition. Application of ZnSO<sub>4</sub>·7H<sub>2</sub>O @ 20 kg ZnSO<sub>4</sub> ha<sup>-1</sup> is recommended. Foliar application of 3 kg ZnSO<sub>4</sub> dissolved in 187 litres of water per hectare, 20-25 days after planting is recommended for rice.

Deficiency of B is observed in highly leached soils. Available B levels less than  $0.5 \text{ mg kg}^{-1}$  in soil can be rated as deficient. Deformation of young leaves, drying/withering of growing points, failure in splitting of leaflets in coconut, chocking etc. are some of the symptoms. Application of  $10 \text{ kg Borax ha}^{-1}$  or 0.5% solution of Borax as foliar spray is recommended.

Where ever crop specific ad hoc recommendations are not available, general recommendations as indicated in the table attached can be adopted.

These ad hoc recommendations can be used to combat problems of deficiency/excess of secondary/micro nutrients until further refinements and modifications are made.

### 1. NPK ratings and recommendations for field crops (Fertilizer recommendations on area basis)

Soil fertility class	% of organic carbon		N as % of general recommendation	Available P ( $\text{kg ha}^{-1}$ )	Available K ( $\text{kg ha}^{-1}$ )	P and K as % of general recommendation
	Sandy	Clayey/Loamy				
0	0.00-0.10	0.00-0.16	128	0.0-3.0	0-35	128
1	0.11-0.20	0.17-0.33	117	3.1-6.5	36-75	117
2	0.21-0.30	0.34-0.50	106	6.6-10.0	76-115	106
3	0.31-0.45	0.51-0.75	97	10.1-13.5	116-155	94
4	0.46-0.60	0.76-1.00	91	13.6-17.0	156-195	83
5	0.61-0.75	1.01-1.25	84	17.1-20.5	196-235	71
6	0.76-0.90	1.26-1.50	78	20.6-24.0	236-275	60
7	0.91-1.10	1.51-1.83	71	24.1-27.5	276-315	48
8	1.11-1.30	1.84-2.16	63	27.6-31.0	316-355	37
9	1.31-1.50	2.17-2.50	54	31.1-34.5	356-395	25

### 2. Ratings and recommendations for Secondary and Micronutrients\*\*\*

#### a. Secondary Nutrients

Nutrient	Deficiency	Sufficiency	Recommendation
Calcium	$<1.5 \text{ me. } 100\text{g}^{-1}$ ( $300 \text{ mg kg}^{-1}$ )	$>1.5 \text{ me. } 100\text{g}^{-1}$ ( $300 \text{ mg kg}^{-1}$ )	As per lime requirement
Magnesium	$<1.0 \text{ me. } 100\text{g}^{-1}$ ( $120 \text{ mg kg}^{-1}$ )	$>1.0 \text{ me. } 100\text{g}^{-1}$ ( $120 \text{ mg kg}^{-1}$ )	$80 \text{ kg MgSO}_4 \text{ ha}^{-1}$
Sulphur	$<5 \text{ mg kg}^{-1}$	$5-10 \text{ mg kg}^{-1}$	$25 \text{ kg S ha}^{-1}$

## b. Micronutrients

Nutrient	Deficiency	Sufficiency	Recommendation
0.1NHCl-Zn (For Acid soils)	<1.00 mg kg <sup>-1</sup>	>1.00 mg kg <sup>-1</sup>	*20 kg ZnSO <sub>4</sub> ha <sup>-1</sup>
DTPA - Zn (for neutral to alkaline soils)	<0.60 mg kg <sup>-1</sup>	>0.60 mg kg <sup>-1</sup>	20 kg ZnSO <sub>4</sub> ha <sup>-1</sup>
0.1NHCl-Cu (For Acid soils)	<1.00 mg kg <sup>-1</sup>	>1.00 mg kg <sup>-1</sup>	**1.5 to 2.0 kg CuSO <sub>4</sub> ·5H <sub>2</sub> O ha <sup>-1</sup>
DTPA - Cu (For neutral to alkaline soils)	<0.12 mg kg <sup>-1</sup>	>0.12 mg kg <sup>-1</sup>	**1.5 to 2.0 kg CuSO <sub>4</sub> ·5H <sub>2</sub> O ha <sup>-1</sup>
DTPA - Fe/ 0.1 NHCl Fe (For both acidic and alkaline soils)	<5.0 mg kg <sup>-1</sup>	>5.0 mg kg <sup>-1</sup>	15 kg FeSO <sub>4</sub> ha <sup>-1</sup>
DTPA - Mn/ 0.1 NHCl Mn (For both acidic and alkaline soils)	<1.0 mg kg <sup>-1</sup>	>1.0 mg kg <sup>-1</sup>	Foliar Spray of 0.5% MnSO <sub>4</sub>
Hot Water Extractable Boron	<0.5 mg kg <sup>-1</sup>	>0.5 mg kg <sup>-1</sup>	10 kg Borax ha <sup>-1</sup> or 0.5% solution of Borax

\*Zn - Application of 3 kg ZnSO<sub>4</sub> dissolved in 187 litres of water per hectare as foliar spray 20-25 days after planting for rice (as 1.65% ZnSO<sub>4</sub> solution to give 0.7 kg Zn ha<sup>-1</sup>).

\*\*Cu - Seedling dip in 1% copper sulphate solution or soaking of seeds in 0.25% copper sulphate solution for rice or 0.025% solution of CuSO<sub>4</sub>·5H<sub>2</sub>O.

\*\*\* The micronutrients should be applied, if found deficient, only on soil test basis.

The laterite and associated soils which constitute more than 70% of cultivated area in Kerala have shown low or medium status in terms of available micronutrients. More than 90% of the soils of Thiruvananthapuram and Kollam districts have shown deficiency of sulphur. Thrissur and Palakkad soils have also indicated deficiency in 80% cases. All soils of Kerala except black soils of Palakkad districts showed varying degrees of deficiency of available Mg. Kuttanad soils have shown deficiency of zinc, copper, calcium and magnesium.

## Appendix 15

### INSTITUTIONS UNDER THE KERALA AGRICULTURAL UNIVERSITY

#### 1. Teaching Institutions

##### Faculty of Agriculture

College of Agriculture, Vellayani, Thiruvananthapuram	0471 - 2381915 0471 - 2382439
College of Horticulture, Vellanikkara, Thrissur	0487 - 2370822 0487 - 2438302
College of Agriculture, Padannakad, Kasaragod	0467 - 2280616
College of Co-operation, Banking and Management, Vellanikkara, Thrissur	0487 - 2438502
College of Forestry, Vellanikkara, Thrissur	0487 - 2370050

##### Faculty of Agricultural Engineering

Kelappaji College of Agricultural Engineering & Technology, Tavanur, Malappuram	0494 - 2686214
--	----------------

#### 2. Regional Agricultural Research Stations

Regional Agricultural Research Station (Northern Zone), Pilicode, Kasaragod	0467 - 2260554
Regional Agricultural Research Station, Ambalavayal, Wayanad	04936 - 260421
Regional Agricultural Research Station (Central Zone), Pattambi, Palakkad	0466 - 2212228
Regional Agricultural Research Station (Special Problem Area Zone), Kumarakom, Kottayam	0481 - 2524421
Onattukara Regional Agricultural Research Station, Kayamkulam, Alappuzha	0479 - 2443192
Regional Agricultural Research Station (Southern Zone), Vellayani, Thiruvananthapuram	0471 - 2382239

#### 3. Other Research Stations

Pepper Research Station, Panniyur, Thaliparamba, Kannur	0460 - 2227287
Cardamom Research Station, Pampadumpara, Idukki	04868 - 236263
Cashew Research Station, Anakayam, Malappuram	0483 - 2864239
Agricultural Research Station, Mannuthy, Thrissur	0487 - 2370726
Banana Research Station, Kannara, Thrissur	0487 - 2699087









Cashew Research Station, Madakkathara, Thrissur	0487 - 2370339
Pineapple Research Station, Vellanikkara, Thrissur	0487 - 2373242
Agronomic Research Station, Chalakudy, Thrissur	0480 - 2702116
Aromatic and Medicinal Plants Research Station, Odakkali, Emakulam	0484 - 2659881
Pineapple Research Station, Vazhakulam, Muvattupuzha, Emakulam	0485 - 2260832
Rice Research Station, Vyttila, Emakulam	0484 - 2809963
Central Nursery, Vellanikkara	0487 - 2438620
Rice Research Station, Moncompu, Alappuzha	0477 - 2702245
Sugarcane Research Station, Thiruvalla, Pathanamthitta	0469 - 2604181
Farming System Research Station, Sadanandapuram, Kottarakkara, Kollam	0474 - 2663535
Cropping System Research Station, Karamana, Thiruvananthapuram	0471 - 2343586
Coconut Research Station, Balaramapuram, Thiruvananthapuram	0471 - 2400621
<b>4. Training and Extension Centres</b>	
Communication Centre, Mannuthy, Thrissur	0487 - 2370773
Central Training Institute, Mannuthy, Thrissur	0487 - 2371104
Agricultural Technology Information Centre, Mannuthy, Thrissur	0487 - 2371340
KAU Press, Mannuthy, Thrissur	0487 - 2370405
<b>5. Krishi Vigyan Kendras</b>	
Ambalavayal, Wayanad	04936 - 260411
Pattambi, Palakkad	0466 - 2212279
Sadanandapuram, Kottarakkara, Kollam	0474 - 2459388
Kumarakom, Kottayam	0481 - 2523120
Mannuthy, Thrissur	0487 - 2375855
Tavanur, Malappuram	0494 - 2686329
Panniyur, Kannur	0460 - 2226087





## Annexure

### RICE AND PULSES

#### 1. Principles of SRI

-  Adaption in areas where regulation of water is possible in second crop season
-  Seed rate @ 5kg/ha
-  Spacing 25-30 cms using markers/rope
-  Transplant seedlings of 8-12 days old
-  Provide drainage channels at every 5 m in main field for proper drainage
-  Maintain field without flooding
-  Let in water before development of cracks
-  Remove weeds using cono-weeder for 4-5 times at 15-20 interval
-  Apply lime, manures and PP chemicals as per POP

#### 2. Management of Bacterial Leaf Blight (BLB)

-  Spraying Streptocycline 250 ppm at the onset of the disease
-  Copper hydroxide (2g l<sup>-1</sup>) as seed treatment, seedling dip and foliar applications at 30 and 45 DAT (Adhoc recommendation)
-  In Organic Management spraying cowdung extract 2% + Pseudomonas fluorescens 2%

#### 3. Management of Cowpea Spotted Pod Borer

-  Bacillus thuringiensis (1g l<sup>-1</sup>) or Beauveria bassiana (20 g l<sup>-1</sup>) two sprays (one at the time of 50% flowering followed by 15 days interval).

