

**FABRICATION AND PERFORMANCE EVALUATION OF VERTICAL  
FARMING STRUCTURE FOR HOMESTEADS**

**By**

**AMEENA R.K.**

**ANJITHA KRISHNA P.R.**

**SREEKUTTY SURESH V.**

**PROJECT REPORT**

**Submitted on the partial fulfillment of the requirement for the degree of**

*Bachelor of Technology*

*In*

*Agricultural Engineering*

**Faculty of Agricultural Engineering and Technology**

**Kerala Agricultural University**



**Department of Land & Water Resources and Conservation Engineering**

**KELAPPAJI COLLEGE OF AGRICULTURAL ENGINEERING AND**

**TECHNOLOGY**

**TAVANUR-679 573, MALAPPURAM**

**KERALA, INDIA**

**2015**

## **DECLARATION**

We hereby declare that, this project entitled “**FABRICATION AND PERFORMANCE EVALUATION OF VERTICAL FARMING STRUCTURE FOR HOMESTEADS**” is a bonafide record of project work done by us during the course of study, and that the report has not previously formed the basis for the award to us of any degree, diploma, associateship, fellowship or other similar title of any other University or Society.

**AMEENA R.K.**

**(2011-02-03)**

**ANJITHA KRISHNA P.R.**

**(2011-02-005)**

**SREEKUTTY SURESH V.**

**(2011-02-041)**

**Place : Tavanur**

**Date :**

## **CERTIFICATE**

Certified that this project entitled “**FABRICATION AND PERFORMANCE EVALUATION OF VERTICAL FARMING STRUCTURE FOR HOMESTEADS**” is a record of project work done jointly by Ameena R.K., Anjitha Krishna P.R., and Sreekutty Suresh V. under my guidance and supervision and that it has not previously formed the basis for the award of any degree, diploma, associateship, fellowship or other similar title of another University or Society.

**Er. Priya. G. Nair**

Assistant Professor

Dept. of LWRCE

KCAET, Tavanur

**Place: Tavanur**

**Date:**

# **ACKNOWLEDGEMENT**

## **ACKNOWLEDGEMENT**

We bow to the lotus feet of ‘God the Almighty’ whose grace had endowed us the inner strength and confidence and blessed us with a helping hand at each step during this work.

With deep sense of gratitude, indebtedness and due respect, we express our heartfelt thanks to our respected guide, Er. Priya G. Nair, Assistant Professor, Department of Land and Water Resources and Conservation Engineering, KCAET, Tavanur for her valuable suggestions, abiding, encouragement and acumen which served as a blessing throughout our work.

We are thankful to Dr. M. Sivaswami, Dean, KCAET, Faculty of Agricultural Engineering and Technology for the unfailing guidance and support that he offered while carrying out the project work.

We engrave our deep sense of gratitude to Dr. Abdul Hakkim V.M., Associate Professor and Head, Department of Land and Water Resources and Conservation Engineering, KCAET, Tavanur.

We sincerely acknowledge the help and suggestions of Sandhya M., Farm Manager, KVK, Malappuram during our project work.

With great pleasure we express our heartfelt thanks to all faculties in the Research Workshop, KCAET, Tavanur for their support and help during the fabrication work.

We would like to express our heartfelt thanks to Mr. Vasudevan, who helped us a lot during the project work.

Words do fail to acknowledge our dear friends for their support, encouragement and help gone a long way in making this attempt a successful one.

We are greatly indebted to our parents, sisters and brothers for their blessings, prayers and support without which we could not have completed this work.

**AMEENA R.K.**

**ANJITHA KRISHNA P.R.**

**SREEKUTTY SURESH V.**

*Dedicated to*  
*Agricultural Engineering*  
*Profession*

## CONTENTS

Chapter No:	Title	Page No:
	LIST OF TABLES	i
	LIST OF FIGURES	ii
	LIST OF PLATES	iv
	SYMBOLS AND ABBREVIATIONS	v
1	INTRODUCTION	1
2	REVIEW OF LITERATURE	8
3	MATERIALS AND METHODS	30
4	RESULTS AND DISCUSSION	42
5	SUMMARY AND CONCLUSIONS	56
	REFERENCE	60
	APPENDICES	ix
	ABSTRACT	

## LIST OF TABLES

<b>Table No.</b>	<b>Title</b>	<b>Page No.</b>
1	Existing vertical farms in the World	6
2	Material used for construction of VFS	31
3	Different treatments used for the study	34
4	Properties of rooting media	37
5	Nutrient Elements of vermicompost	37
6	Temperature requirement of tomato	38



## LIST OF FIGURES

Fig No.	Title	Page No.
1	Fabricated Vertical Farming Structure (VFS)	32
2	Experimental layout for VFS	34
3	Experimental layout for potted cultivation	35
4	Variation of Air Temperature of VFS and Potted cultivation at 8:00 am during three week period	43
5	Variation of Air Temperature of VFS and Potted cultivation at 1:30 pm during three week period	44
6	Variation of Air Temperature of VFS and Potted cultivation at 5:00 pm during three week period	44
7	Variation of Relative Humidity of VFS and Potted cultivation during three week period	45
8	Variation of Rooting media Temperature of VFS and Potted cultivation at 8:00apm during three week period	46
9	Variation of rooting media temperature of VFS and Potted cultivation at 1:30pm during three week period	47
10	Variation of rooting media temperature of VFS and potted cultivation at 5:00 pm during three week period	47
11	Variation of plant Heights in different treatments of VFS and Potted cultivation	48
12	Variation of plant girth in different treatments of VFS and potted cultivation	49

13	Variation of number of leaves in different treatments of VFS and potted cultivation	50
14	Variation of plant height in different treatments of VFS and potted cultivation	51
15	Variation of plant girth in different treatments of VFS and potted cultivation	52
16	Variation of number of leaves in different treatments of VFS and potted cultivation	53
17	Yield of amaranthus from VFS and potted cultivation	54

## LIST OF PLATES

<b>Plate No</b>	<b>Title</b>	<b>Page No</b>
1	VFS placed in the balcony of flat, KCAET	35
2	Arrangements of pots in the flat balcony, KCAET	36

## SYMBOLS AND ABBREVIATIONS

ABC	Aluminium Brass and Chrome
AD	Anno Domini
BC	Before Christ
C	Carbon
CEA	Controlled Environment Agriculture
Cm	Centimeters
CO <sub>2</sub>	Carbon dioxide
° C	Degree Celsius
dB	Decibel
dS/m	DeciSiemens per meter
Dept.	Department
DLR	Dockland Light Railway
E	Evaporation
ET	Potential evapotranspiration
EU	European Union
eg.	Example
et al	And others
Fig.	Figure
Ft	Feet
FYM	Farm Yard Manure
Gm	Gram (s)
Gm/m <sup>2</sup>	Gram (s) per square meter( s)
Gwh	Giga Watt hour
GHG	Green House Gas

ha	hectare
hp	horse power
hrs	Hours
i.e.	That is
inch	inches
j.	Journal
K	potassium
KAU	Kerala Agricultural University
KCAET	Kelappaji College of Agricultural Engineering and Technology
kg(f)/cm <sup>2</sup>	Kilogram force per centimeter square
kg/cm <sup>2</sup>	Kilogram per centimeter square
kg/ha	Kilogram per hectare
kg /m <sup>2</sup>	Kilogram per meter (s)
KPa	Kilo pascal
KWh/m <sup>2</sup>	Kilowatt hour per square meter
lbs	Pounds
Ltd.	Limited
LDCs	Least Developed Countries
LED	Light Emiting Diode
L W R C E	Land and Water Resources Conservation Engineering
m	Meter (s)
m <sup>2</sup>	Square meter (s)
ml	milli litre
mm	millimeter

Mg	Magnesium
N	Nitrogen
NGO	Non Governmental Organization
NTF	Nitrifying Trickling Filter
P	Phosphorus
PVC	Poly Vinyl Chloride
rpm	revolution per minute
sec	Second
ton/acre	Tone( s) per acre (s)
RSI	Relative Strength Index
U. S	United States
UV	Ultra Violet
USDA	United States Department of Agriculture
V	Volt
viz	Which are
VF	Vertical Farming
VFS	Vertical Farming Structure
Vs.	Versus
W	Watts
&	and
°	Degree (s)
/	Per
%	percentage
'	Minute (s)
"	second (s)

# **INTRODUCTION**

# INTRODUCTION

The invention of agriculture dates back some 10,000 years and arose spontaneously at multiple sites throughout the world. It rapidly spread to almost every culture, offering a better life to those who embraced it. Modern day agriculture is a major contributor to the large range of environmental problems the world is facing at present. Agricultural run-off, ecosystem degradation and loss, use of fossil fuel, food wastage, artificial irrigation and use of the world's freshwater supply are few in a long list of issues that needs to be addressed if current agricultural practice is to be made truly sustainable in the future.

Our population has grown to 7 billion and we are expected to be around 9.5 billion by 2050 (U.N., 2004, Gerber *et al.*, 2011). By that time the United Nations (U.N) estimates that 80% of the world's population will be living in urban areas. In approximately 5 years, 153 of the world's 358 cities will have more than one million inhabitants, 15 of them will be in Asia. Countries around the world are catching up with More Developed Countries' (M.D.Cs) standards of living and food habits and consume an increasing amount of resources. More water, energy, land and food are needed to feed this growing population, this increases demands and drives prices up but it also produces more waste and pollution than ever before. One major issue is the lack of arable land to support the world's growing population. If the world does population to 9.5 billion, a staggering 2.1 billion more acres will be required to feed the world population. This enormous amount of land simply does not exist. In order to support our current scale of agriculture, millions of hectares of natural land have been altered and the consequences it has had on our planets ecosystems and biodiversity are severe (Groom *et al.*, 2005). Wetlands, estuaries, grasslands, temperate and tropical forests are a few examples of the biomes that have been severely affected, damaged or in many cases completely lost as a result of our practice. Agriculture also requires vast amounts of water and currently consumes 70% of the worlds available freshwater. If the current trends continue, safe drinking water will be scarce in many areas of the world and compete even more with agriculture than it does today. To adapt to the future, it has been argued that we need to increase the resilience of our cities. (Folke *et al.*, 2010).



Urban agriculture has been defined as “the growing, processing and distribution of food and non-food plant and tree crops and the raising of livestock, directly for the urban market, both within and on the fringe of an urban area. These agricultural activities take many forms and occur at multiple scales in cities throughout the world, responding to the needs and preferences of urban residents. Growing evidence suggests that incorporating types of agriculture into the urban environment will greatly improve the sustainability of cities, particularly if these systems are designed to take advantage of the resources and markets available there. Urban agriculture offers a new frontier for land use planners and landscape designers to become involved in the development and transformation of cities to support community farms, allotment gardens, rooftop gardening, edible landscaping, urban forests, and other productive features of the urban environment.

Montreal, for example, has a well-distributed urban agriculture system with 97 community gardens that provide 8,200 separate plots. These garden spaces have been recognized for their contributions to community socializing, empowerment of individuals, and enhancing technical knowledge. In Beijing, multifunctional urban agriculture is a new trend for producing food and as a result, organic diversified farms and extensive greenhouses have emerged throughout the city. In Shanghai, China urban agriculture activities within the city supply 60% of the vegetables and 90% eggs consumed by the residents. In the Netherlands, 250,000 community and allotment gardens exist across 4,000 hectares of land and Amsterdam alone contains 350 hectares of land for urban gardens.

While the opportunity to use urban agriculture as a sustainable land use strategy is vast, several challenges are there. One of the greatest constraints to the widespread adoption of urban agriculture is the limited access to land for those who would like to grow food, and the lack of secure of tenure on that land, particularly where the production functions are competing with other uses( such as commercial development ) that provide greater profit for the land owner. Marginalized groups and minority populations are particularly vulnerable to the problem of land access and security, since they often do not have the means to purchase land. Another barrier to urban agriculture is the limited availability of land that is actually suitable for producing food based on the location, size, and access to necessary resources. Solar access for an existing site is an important factor, since most edible plants have a relatively high sunlight requirement, but the

future access to sunlight (depending on new construction and growth of trees) should be considered. An appropriate growing media, typically soil, is an important resource for growing plants. While the ideal site would offer a rich soil that is high in nutrients and organic matter, many urban agriculture projects are established on poor soils, or even impervious surfaces, often by building raised beds and hauling in the necessary soil and amendments. Other considerations for the site include: protection from vandalism and theft, access for gardeners, proximity to markets, and aesthetics of the neighborhood. The successful integration of urban agriculture into the complex ecosystem of a city requires planning beyond the production sites themselves. Insufficient infrastructure and supportive services for the entire food system can severely limit the widespread adoption of these systems.

Imagination and innovation have allowed human civilization to overcome numerous obstacles that it has encountered. Currently, agricultural limitations and persistent famines have reached a breaking point, which requires human innovation to step in and solve this pressing issue. An alarming number of agricultural problems inspired Dickson Despommier, Professor of Environmental Health Science and microbiology at Columbia University, to come up with a unique idea-VERTICAL FARMING. Vertical farming can be defined as farming fruits, vegetables, grains, etc in the middle of a city inside of a building where different floors have different purposes (one floor for a certain crop, another floor for a vegetable, etc) using hydroponics (water with nutrients). There are many developments taking place today that apply the concept of urban agriculture, and the concept of vertical farming is a large scale extension of urban agriculture. The Vertical Farm Project was established in 2001, and is an on-going activity at the Mailman School of Public Health at Columbia University in New York City. It is in its virtual stages of development, having survived 4 years of critical thinking in the classroom and world wide exposure on the internet to become an accepted notion worthy of consideration at some practical level. Ashmawy (2006) conducted a study on green wall technology and mentioned that the ancient concept of Green walls was built in Babylon about 2500 years ago. In ancient Babylon, King Nebuchadnezzar II built the Hanging Gardens of Babylon: a wonder of the ancient world, and ancestor of the modern green wall. Between 3<sup>rd</sup> BC 17<sup>th</sup> AD Romans train grape on garden trellies and on villa walls. In 1920's Britania and North America promote trellis structures and self-climbing plants on houses and gardens. In 1988 started to use stainless steel cable system for green facades. Early 1990's cable and wire-rope net systems and modular trellis

panel systems enter the North American marketplace. First major application of a trellis panel system had been used in Universal City Walk on California in 1993 and in 1994.

In concept, vertical farms are multistory buildings with highly controlled environmental conditions and access that house year-round crop production in artificial environments by using hydroponics, aeroponics and aquaponics. All food is grown organically without herbicides or pesticides and black and grey water is collected and recycled. The vertical farm is powered by solar and wind energy to balance out the high-energy consumption the internal environment requires. Rooftop farming uses the roof footprint of a building to cultivate crops in raised beds that are open and exposed to weather elements or to cultivate crops that are partially or fully enclosed in a greenhouse structure. An actual vertical farm requires a substantial investment in building or repurposing and outfitting a building to create the necessary indoor environment for year round maximum crop production that utilizes a small urban footprint and minimal water and energy resources. Growing crops in skyscrapers would not only mitigate the need for more land, it would also produce available growing space in the air. Also, farming in a controlled environment would drastically increase yields and decrease water use, waste production, and disease transmission. Vertical farming would also allow local crops to be produced year round, discarding the need for transporting food and thus, decrease greenhouse gas emissions (Despommier, 2009).

Vertical Farming provides a paradigm shift in the way we know and do agriculture. In terms of space, abandoned urban properties, abandoned mines or even peripheries of buildings can be converted into food production centers thereby eliminating the need for expensive constructions. Owing to optimum use of vertical space 1 indoor acre is equivalent to 4-6 outdoor acres or more, depending upon the crop (e.g., strawberries: 1 indoor acre = 30 outdoor acres), something that is inconceivable in case of conventional or greenhouse agriculture. This intensifies agriculture instead of intensifying it. Due to provision of artificial light at the required wavelength (380-450 nm in the violet end and 630-700 nm in the red end) for an optimal duration, crop production becomes a year round enterprise, comparable with other manufacturing industries. It also creates new employment and research opportunities. Technologies developed for VF may prove to be useful not only for remote research stations like in the poles, but also in refugee camps especially in flooded or earth quake affected areas where camp dwellers need to

be fed for prolonged period of time. Agriculture has always been affected by volatilities of weather. Fluctuations in temperature, water availability, and photo-intensity beyond the biological requirements of the plants have persistently led to diminishing yields. These factors have always remained beyond the control of farmers and could only be prevented through costly chemicals, avoidance of high-risk high-production crops, or purchase of crop insurance. Vertical Farming systems address many of these problems. Like greenhouse agriculture, there is no weather-related crop failure due to droughts or floods as irrigation is artificial and controlled. Temperature and photo-intensity and duration are also artificial and optimal. Although the balance of energy required for artificial lighting, heating and cooling and that generated by bio-gas is a matter requiring further research, VF dramatically reduces fossil fuel use since there is no agricultural machinery or inorganic fertilizer involved. Furthermore, since food is grown locally or closer to points of consumption, transportation is reduced, thus saving on energy and the environment. At least high value fruits and vegetables cultivated in Vertical Farms has the potential to take some pressure from agriculture whereby, fertile lands can be utilized for cereal, fodder, fiber and bio-fuel production. VF may additionally create sustainable environments for urban centers purifying the air and providing a positive psychological effect on urban populace, who are often deprived of greenery.

Although vertical farming has been advocated for sometime (beginning in 1999) by a few spokespersons, up until 3 years ago, there were no examples to be found anywhere in the world. During the interim, however, a handful of vertical farms, many of them commercially viable, have been established. Some of the commercial vertical farms existing in the world are shown in Table 1. Nonetheless, the concept of farming within the city inside high-tech vertical green-houses is still too new to conclude that these technology-driven agricultural initiatives will be successful on a world-wide scale, either from an economic and/or social perspective. Furthermore, even if they should become common place as part of the normal built environment, their impact on ecological processes will take many years to manifest itself in terms of global climate change.

**Table 1. Existing Vertical Farms in the World**

Location	Owner	Details	Location Type
South Korea	Rural Development Authority	Three stories tall Experimental Uses grow lights	Rural
Japan	Plant factories (numerous-50+) Nuvege	Half use sunlight and the others use grow lights (Nuvege) Many are commercially successful	Peri-domestic
Singapore	Sky Greens	Commercial Four stories tall Uses sunlight	Inside the city limits
Chicago	The Plant	Three stories NGO Uses grow lights	Inside the city limits
Chicago	Farmed Here	Commercial Uses grow lights	Inside the city limits
Vancouver	Alterrus	Uses sunlight Four stories tall	Inside the city limits

If vertical farming (VF) were to become widely adopted, then the following advantages would most likely be realized:

1. Year-round crop production; 1 indoor acre is equivalent to 4-6 outdoor acres or more, depending upon the crop (e.g., strawberries: 1 indoor acre = 30 outdoor acres).
2. VF holds the promise of no crop failures due to droughts, floods, pests, etc.
3. All VF food will be grown organically employing chemically defined diets specific to each plant and animal species: no herbicides, pesticides, or fertilizers.
4. VF eliminates agricultural runoff.

5. VF would allow farmland to be returned to the natural landscape, thus restoring ecosystem functions (e.g., increases biodiversity) and services (e.g., air purification).
6. VF would greatly reduce the incidence of many infectious diseases that are acquired at the agricultural interface by avoiding use of human feces as fertilizer for edible crops.
7. VF converts black and gray water into potable water and the collection of the water realized through evapotranspiration.
8. VF adds energy back to the system via methane generation from composting non-edible parts of plants and animals.
9. VF dramatically reduces fossil fuel use (no tractors, plows, shipping).
10. VF eliminates much of the need for storage and preservation, thus reducing dramatically the population of vermin (rats, mice, etc.) that feed on reserves of food.
11. VF converts abandoned urban properties into food production centers.
12. VF creates sustainable environments for urban centers.
13. VF creates new employment opportunities.
14. VF may prove to be useful for integrating into refugee camps.
15. VF offers the real possibility of measurable economic improvement for tropical and subtropical Least Developed Countries and can reverse the current trend in population growth of LDCs, since they adopt urban agriculture as a strategy for sustainable food production.
16. VF could reduce the incidence of armed conflict over natural resources, such as water and land for agricultural use.

In view of all the above facts this study has undertaken to evaluate with the following specific objectives:

1. To fabricate a vertical farming structure suitable for balcony of the flat system
2. To evaluate the performance of fabricated vertical farming structure
3. To compare the performance of vertical farming structure with potted cultivation

# **REVIEW OF LITERATURE**

# REVIEW OF LITERATURE

Overpopulation is estimated to occur in the next few decades. The world's massive urbanization and the need to create "sustainable cities" that provide enough food, shelter and basic services for all urban residents now and in the future will be a great challenge for the next millennium. Urban agriculture can have many different purposes, including food security, ecology and income generation. Making use of unused spaces such as rooftops, which are abundant in cities, for urban areas food production is one such creative solution that can contribute to resident's food security and employment. Vertical farming will be a worthwhile project because it replaces the thousand of crop acres by simple buildings, it recycles water, and it protects the food from weather hazards.

## 2.1 Constraints in Improving Agricultural Production

Day Phillip (2009) studied on constraints in increasing agricultural productivity in Nigeria. These constraints include those arising from agricultural policies formulated over time. Some constraints, such as poor and untimely release of funds and high offshore costs of equipment, limit the implementation of the presidential initiatives. Others, such as aging and inefficient processing equipment and high on-farm costs of agrochemicals, limit the effective functioning of the value chains (production, processing, and marketing) for key agricultural commodities.

The study conducted by Turner and Allison H. (2009) concluded that contaminated soil poses challenges for agricultural uses, as urban farmers, gardeners, and bystanders (particularly children) can absorb contaminants into their bodies via skin contact with, ingestion of, or inhalation of contaminated soil or plants. If contamination proves too cost-prohibitive to remedy, contained systems can be used to bypass exposure. These include both soil covers and contained food-production methods such as raised beds, hydroponic or aquaponic systems, and vertical or container-based gardening systems.

Adeleke Salami (2010) investigated the trends, challenges and opportunities of sub-sector in East Africa through case studies of Kenya, Ethiopia, Uganda and Tanzania. This study



finds that at the national level, weak institutions, restricted access to markets and credit and inadequate infrastructure causes constrained productivity growth of smallholder farming.

Estes *et al.* (2010) showed that raised beds filled with fresh compost can become re-contaminated over time, due to runoff and windborne dust from contaminated areas.

Fengxia Dong (2010) examined the credit constraints which affect agricultural productivity and rural household income in China. The findings of the study suggested that under credit constraints, production inputs, along with farmers' capabilities and education, cannot be fully employed. By removing credit constraints, agricultural productivity and rural household income can be improved.

## **2.2 Improvements of urban agriculture**

Chaney *et al.* (1984) conducted a study on the potential for heavy metal exposure from urban gardens and soils. Eating vegetables grown in contaminated soils could cause health problems because the plants generally absorb heavy metals in their edible tissues. They also revealed that rainwater is the best source of water for watering plants; it reduces the pressure exerted on the municipal water network. The temperature of rainwater is naturally warm and will not shock the plants, contrary to cold water from the waterworks system. In addition, this water does not contain chlorine, which inhibits plant growth.

Hynes and Patricia (1996) concluded that urban agriculture can contribute significantly to the development of social connections, capacity building, and community empowerment in urban neighborhoods, most commonly through community gardening.

Brown and Jameton (2000) conducted a study on the public health implications of urban agriculture and concluded that the cities can contribute to positive health outcomes directly.

Kaufman and Bailkey (2000) reported that the urban agriculture can contribute to environmental management and the productive reuse of contaminated land, including brown fields. As a result of increased plant foliage, urban agriculture can reduce storm water runoff and air pollution, and can increase urban biodiversity and species preservation.

Gilhooley (2002) conducted an experiment and found that the participants of who worked in an environment with plants 12% more productive were less stressed than those who worked in an environment with no plants.

Caton Campbell *et al.* (2003) reported that to mitigate the challenges and to create more secure land tenure for urban gardeners and farmers, foundations can provide financial support for community land trusts, conservation groups, or urban agriculture related organizations to secure land tenure through ownership or long-term agreements.

Hansen and Donohoe (2003) conducted a study on health issues of migrant and seasonal farm workers. The study indicated that industrial agriculture has till date used agricultural machinery, advanced farming practices and genetic technology to increase yield. However, agriculture still largely depends on season, especially in case of fruit and vegetable crops. Socio-economically this renders the farming population under or unemployed for a greater part of the year. While in industrialized nations, higher food prices, greater affordability and government subsidies ease this problem to some extent, in developing countries, where subsistence agriculture is the norm, this translates to poverty and vulnerability.

Bellows *et al.* (2004) conducted a study on health benefits of urban agriculture. They concluded that urban agriculture also provides opportunities for public health programming to improve nutrition knowledge, attitudes, and dietary intake.

Dubbeling and Merzthal (2006) reported that urban agriculture presents many economic opportunities. It can decrease public land-maintenance costs, increase local employment opportunities and income generation, and capitalize on underused resources (e.g., rooftops, roadsides, utility rights-of-way, vacant property). Urban agriculture can also increase property values and produce multiplier effects through the attraction of new food-related businesses, including processing facilities, restaurants, community kitchens, farmers markets, transportation, and distribution equipment.

Mubvami and Mushamba (2006) reported that an important determinant of urban agriculture's long-term success is the availability and access to space for food production and processing purposes.

Tixier and Bon (2006) did a study on urban horticulture. They revealed that the success of urban agriculture, like that of traditional rural agriculture, is dependent on a variety of factors, including weather, light, labour, agricultural skills and knowledge; capital and operating funds; access to land or other growing space; land tenure; access to healthy, uncontaminated soil or other growing medium; and access to water.

Raja *et al.* (2008) suggested that a community-based food-systems approach has the potential to simultaneously address issues of food security, public health, social justice, and ecological health in local communities and regions, as well as the economic vitality of agriculture and rural communities. Such an approach emphasizes, strengthens, and makes visible the relationships among producers, processors, distributors, and consumers of food at the local and regional levels.

Teig *et al.* (2009) concluded that urban agriculture can foster community building, mutual trust, sharing, feelings of safety and comfort, and friendships that translate into a collective investment in the common good of a neighborhood. It can also serve as an alternative vacant property reuse strategy to decrease or prevent crime, trash accumulation, illegal dumping, littering, juvenile delinquency, and fires, and as a catalyst for additional community development activities and positive place-based programs.

Vitiello *et al.* (2009) studied on community gardening in Philadelphia. They revealed that subsistence production reduces food expenditures and makes household income available for other purposes. For example, in 2008, community and squatter gardens in Philadelphia produced summer vegetables worth approximately \$4.9 million, an amount greater than the combined sales of all of Philadelphia's farmers markets and urban farms.

Clurfeld (2011) reported that over the next few years large-scale CEA operations will begin to supply more food to New Yorkers as well as residents of other cities, including Montreal.

Zuhal Kaynakci Elinç (2013) reported that increasing the availability of natural vegetation in urban areas is also very important for inner city wild life. More an area is covered with vegetation, the higher the potential of maintaining different kinds of wild life.

### 2.2.1 Rooftop gardening

Nakamura and Oke (1988) conducted a study in East-West oriented urban canyon and found that temperatures in the urban canyon and temperatures in the lower part of the urban boundary layer are usually very similar. Thus, higher temperatures above the roofs can affect temperatures at canopy level, and in areas with only one or two story buildings, the roofs may be at the canopy level.

Peck *et al.* (1999) evapotranspiration from rooftop vegetation could cool the roof, reducing the amount of heat flow into the building through the roof. The lower rooftop temperature would also reduce the temperature of the external air that is exchanged with the building's air. The temperature of this air could also be reduced if the rooftop garden is designed so as to shade the intake valves. Temperatures as low as 25 °C was observed. During the winter, the rooftop garden would provide additional insulation, which would reduce the flow of heat through the roof.

Man, D (2011) conducted a study on rooftop greenhouses in New York City and reported that the commercial viability of rooftop hydroponic greenhouses depends on the production of high-value products, such as micro greens or tomatoes, which can be sold at a premium, especially in the off-season.

Rifkin (2011) conducted a study on cash crops under glass and up on the roof. He concluded that if community gardens represent one approach to urban agriculture, one which emphasizes community empowerment and engagement while making full use of often limited resources, rooftop greenhouses lay at the other end of the spectrum. Because of their high initial capital costs (around \$2 million for a one-acre greenhouse) and by virtue of the fact that they are located on roofs which have limited public access, the development of rooftop greenhouses (and to a lesser degree, open rooftop farms) tends to be motivated more by the aim of establishing high- yield, innovate food production as a profitable enterprise in urban setting.

### **2.3 Concept of Vertical Farming**

Goode and Patrick (1986) studied about vertical gardens and found that vertical gardens, in the form of hanging gardens was existed in pre-Columbian Mexico and India, and in some of the Spanish homes of 16<sup>th</sup> - 17<sup>th</sup> century in Mexico.

Mitchell (1994) conducted a study on bio regenerative life-support systems. The study found that an estimated 28 m<sup>2</sup> area of intensively farmed indoor space is enough to produce food to support a single individual in an extra-terrestrial environment like a space station or space colony supplying with about 3000 Kcal of energy per day.

In 2001, Dickson Despommier proposed a concept to reduce agriculture's ecological footprint by using vertical farming which built agriculture into the city and expanded it in vertical direction. He reported that the vertical farming concept in Thailand can be conducted with greater effectiveness because of the warm climate when compared to planting in places with a cold climate since there is no need to grow vegetables in a closed environment, which requires climate control.

### **2.4 Advantages and disadvantages of Vertical Farming**

Doernach (1979) found that building protection is primarily by vertical gardens by reducing temperature fluctuations of the building envelope. Decreased temperature fluctuations reduce the expansion and contraction of building materials and extend the building's lifespan.

Minke (1982) found that without greening, flat roofs were 50% more susceptible to damage after 5 years than slightly sloped roofs (e.g., 5% slopes). This was because water tends to pool instead of running off. If the drainage layer isn't sufficient or if drainage routes become blocked, green roofs can cause some flat roofs to leak due to continuous contact with water or wet soil. With insufficient drainage, the plants will also be susceptible to the impact of wide degrees of variability in the moisture content of the soil. For example, with too much water, the soil can go sour and the plants can drown or rot.

Baumann (1986) found that green walls can reduce wall temperature as much as 15°F which results in significant air conditioning savings.

Fjeld *et al.* (1998) conducted a study on the effect of indoor foliage plants on health and discomfort symptoms among office workers. The study showed that the plants reduce wind-speed also they prevent dust with wet environments which created with their roots and leaf. By means of this event, plants bring about extinction to harmful microorganisms with on site sap and juice. Air quality improvement from plants has been shown to reduce coughs by thirty percent and dry throat and irritation by twenty-four percent also, the plants clean the office air by absorbing pollutants into their leaves and transmitting the toxin to their roots, where they are turned into food for the plant.

Peck *et al.* (1999) reported that the beauty of a green wall (covering concrete and steel) can rejuvenate our minds and physical fatigue was greatly reduced. The presence of plants in the office not only reduces stress but also helps to increase productivity of workers. They also analyzed that VF cause improved air quality, due to the reduction in the rate of smog formation and the ability of vegetation to filter or absorb certain pollutants out of the atmosphere. The study also found that the application of vertical gardens is shown to increase property values by dramatically increasing the amenity of buildings, and establishing higher public acclaim, transforming them into recognizable landmarks.

Dunnett and Kingsbury (2004) found that soil and plants which were used for arrangements in Vertical Gardens have a voice absorption feature.

Facharbeit von (2011) pointed out that the biggest advantage of vertical farming is the space advantage. Furthermore, there is no wastage of water, crops are not exposed to extreme weather conditions, there is a reduction of CO<sub>2</sub> emissions and new recycling techniques seem to be ecologically friendly.

Endogen (2013) found that approximately 1 square foot of vegetated wall area will filter the air for approximately 100 square feet of office area. Considered in very general sense, planting one wall of any house which situated 50 houses on the street is equal to plant 50 trees on this street.

Yamada (2008) found that green walls in cooling buildings and combating the heat island effect and greatly reduce this effect by absorbing a lot of the heat through the evaporation process.

Walsh, B (2008) reported that it will cost \$20 million to \$30 million for a prototype, but hundreds of millions to build a 30-story farm. He concluded that with high construction and energy costs, vertically raised food will most likely be more expensive than traditional crops and thus not be able to compete in today's current market.

## **2.5 Scope of Vertical Farming**

Rimmer and Powell (1992) reported that there is an increasing demand for protein, vitamin and mineral rich food as more and more countries transition from developing to developed nations. Despite Engel's law of declining share of food related expenditure with increasing income, there is expected to be a change in the consumption pattern in these. In particular there is an expectation of reduced consumption of unprocessed bulk commodities (e.g., grain, rice and cereals) along with an increased consumption of higher valued consumer ready products (e.g., fruit, meat and dairy products). This changing consumer preference is an external factor that might serve as an opportunity for Vertical Farming because it is particularly efficient in producing sensitive crops of high nutritional value away from their native agro-climatic zones.

Elhadj (2005) conducted experiments in achieving water and food self-sufficiency in the Middle East. The experiment reported that recent decades have seen food sovereignty being sought by many nations and recommended by many think-tanks in view of the volatility of food prices. This is seen especially in geographical regions where purchasing power is high but agro-climatic factors too hostile for conventional agriculture, like in Deserts, Taigas and Tundras. VF could generate this sovereignty to a certain extent.

Martius *et al.* (2005) revealed through their study that at least high value fruits and vegetables cultivated in Vertical Farms has the potential to take some pressure from agriculture whereby, fertile lands can be utilized for cereal, fodder, fiber and bio-fuel production. VF may additionally create sustainable environments for urban centers purifying the air and providing a positive psychological effect on urban populace, who are often deprived of greenery.

Richard (2005) showed that the biggest threat to VF is skepticism from business and academia, and it is not entirely unfounded. Till date no project has practically demonstrated the viability of a VF at this scale, most exist in small research initiatives or as concept drawings by

architects. Therefore it is imperative that initiation leave alone acceptance would require convincing at different levels and hence requires some serious action research.

Banse *et al.* (2008) reported that global climate change presents an opportunity for Vertical Farming to get greater social and political acceptance. In addition to this there is an increasing controversy regarding the use of arable land for bio-fuels and the later contributing towards rising of food prices. Vertical Farming can relieve high yielding land, now used for fruit and vegetable cultivation.

Despommier (2010) reported that the VF buildings would have to act as separate standalone vertical farms devoted entirely to the purpose of water purification. Instead, biomass produced in these buildings could be used in biofuel production adding an additional cost benefit to the solution. Resulting purified water would be drinking quality and could be used as irrigation water in food-producing vertical farms or simply be reused as drinking water.

Kretschmer *et al.* (2011) found that vertical farming is a worthwhile project because it replaces the thousand of crop acres by simple buildings, it recycles water, and it protects the food from weather hazards.

Levenston (2011) conducted a study on vertical farm of Suwon, a South Korean city. The facility was three stories in height totaling an area of 450 m<sup>2</sup>. Almost 50% of the energy requirement was supplied through renewable resources like geothermal and solar arrays, which was mainly necessary for heating, cooling and artificial lighting requirements. Lettuce was being cultivated through careful regulation of light, humidity, carbon dioxide and temperature.

## **2.6 Types of vertical farming**

Jacobs (2008) conducted a study about, benefits and design green walls technology. The report introduced several types of vertical gardens like modular trellis panel system, grid and wire-rope net systems, living wall systems, landscape walls and modular living wall system.



## **2.7 Suitability of plants in vertical farming**

Johnston and Newton (2004) reported the types of plants in vertical farming as self-clinging climbers, Twining climbers (Support needed, thin steel wires, roughened plastic lines or timber battens running vertically will suffice for some species.) and rambling shrubs.

## **2.8 Rooting media used in vertical farming structures**

Minke and Witter (1982) found in Ontario, Canada a typical residential roof is designed for a load of approximately 30-40 lbs per square foot (146-195 kg per square meter), which does not include snow loading. If soil is used as the growing medium, the depth for planting is limited to less than 3 inch (7.6 cm). An extensive green roof is much lighter than an intensive green roof, with the lightest grass roof weighing as little as 11.2 lbs. (55 kg/m<sup>2</sup>) including 2.36" (6 cm) of substrate.

Thompson(1998) reported that the growing medium in green walls, typically made up of a mineral-based mix of sand, gravel, crushed brick, lexica, peat, organic matter and some soil, varies in depth between 5-15 cm, a weight increase of 72.6-169.4 kg per m<sup>2</sup>. Due to the shallowness of the soil and the extreme desert-like microclimate on many roofs, plants must be low and hardy, typically alpine, dryad or indigenous. Plants are watered and fertilized only until they are established and after the first year, maintenance consists of two or three visits a year for weeding of invasive tree and shrub species, mowing, and safety and membrane inspections.

Ellis (2012) showed that the soilless culture has the potential of saving incredible amounts of water compared to current outdoor agricultural techniques. Experience has shown that it can use as little as a 1/20 of the amount of water as regular to produce the same amount of food. The hydroponics use 70% less water than current agricultural practice and geaponics use 70% less water than hydroponics.

### **2.8.1 Vermicompost**

Bhadauria and Ramakrishnan (1996) conducted an experiment on role of earthworms in nitrogen cycle during the cropping phase of shifting agriculture (jhum) in North East India and reported that during the fallow period intervening between two crops at the same site in 5- to15-year jhum system, earthworms participated in N cycle through cast-ejection, mucus production

and dead tissue decomposition. The total soil N made available for plant uptake was higher than the total input of N to the soil through the addition of slashed vegetation, inorganic and organic manure, recycled crop residues and weeds.

Evans *et al.* (1996) conducted a study on the source variation in physical and chemical properties of coconut coir dust. The result showed that cocopeat has good physical properties, high total pore space, high water content, low shrinkage, low bulk density and slow biodegradation.

Jadhav *et al.* (1997) studied the influence of the conjunctive use of FYM, vermicompost and urea on growth and nutrient uptake in rice. The results showed that the uptake of N, phosphorus (P), potassium (K) and magnesium (Mg) by paddy (*Oryza sativa*) plant was highest when fertilizer was applied in combination with vermicompost.

Mitchell and Edwards (1997) cited that vermicompost reduces the proportion of water-soluble chemical species, which cause possible environmental contamination.

Labeke and Dambre (1998) conducted a study on the gerbera cultivation on coir with recirculating of the nutrient solution, a comparison with rockwool culture. They observed that plants in cocopeat had periodically shorter stems than plants on rockwool however, their weights were higher.

Reddy *et al.* (1998) conducted a study on the effect of organic and inorganic sources of NPK on growth and yield of pea (*Pisum sativum*). The results of the study indicated that vermicompost enhances transplant growth rate of vegetables. In addition, there were no symptoms of early blight lesions on the fruit at harvest. The yield of pea (*Pisum sativum*) was also higher with the application of vermicompost (10 t ha<sup>-1</sup>) along with recommended N, P and K than with these fertilizers alone.

Vadiraj (1998) conducted an experiment on response of coriander (*Coriandrum sativum*) cultivars to graded levels of vermicompost. The experiment reported that application of vermicompost produced herbage yields of coriander cultivars that were comparable to those obtained with chemical fertilizers.

Blom (1999) conducted a study on coco coir versus granulated rock wool and 'arching' versus traditional harvesting of roses in a recirculating system. The results revealed that cocopeat used alone, or as a component of soil medium, is suitable for roses.

The efficiency of vermicompost was evaluated in a field study by Desai *et al.* (1999). They stated that the application of vermicompost along with fertilizer N gave higher dry matter (16.2 g plant<sup>-1</sup>) and grain yield (3.6 t ha<sup>-1</sup>) of wheat (*Triticum aestivum*) and higher dry matter yield (0.66 g/plant) of the coriander (*Coriandrum sativum*) crop in sequential cropping system.

Karmegam *et al.* (1999) conducted a study on the effect of vermicompost on the growth and yield of greengram (*Phaseolus aureus* Rob.). The study showed that vermicompost plays a major role in improving growth and yield of different field crops, vegetables, and flower and fruit crops. The application of vermicompost gave higher germination (93%) of mung bean (*Vigna radiata*) compared to the control (84%). Further, the growth and yield of mung bean was also significantly higher with vermicompost application. Likewise, in another pot experiment, the fresh and dry matter yields of cowpea (*Vigna unguiculata*) were higher when soil was amended with vermicompost than with indigested slurry.

Maheswarappa *et al.* (1999) in his study on the influence of organic manures on yield of arrowroot, soil physico-chemical and biological properties when grown as intercrop in coconut garden showed that the application of organic matter including vermicompost favorably affects soil pH, microbial population and soil enzyme activities.

Nethra *et al.* (1999) conducted study on China aster (*Callistephus chinensis*) cultivation using vermicompost as organic amendment. The fresh weight of flowers such as *Chrysanthemum chinensis* increased with the application of different levels of vermicompost. Also, the number of flowers per plant (26), flower diameter (6 cm) and yield (0.5 t ha<sup>-1</sup>) were maximum with the application of 10 t ha<sup>-1</sup> of vermicompost along with 50% of recommended dose of NPK fertilizer. However, the vase life of flowers (11 days) was high with the combined application of vermicompost at 15 t ha<sup>-1</sup> and 50% of recommended dose of NPK fertilizer.

Thompson and Nogales (1999) studied about Nitrogen and carbon mineralization in soil of vermicomposted and unprocessed dry olive cake ('Orujo seco') produced from two stage centrifugation for olive oil extraction. The result showed that The C: N ratio of the unprocessed

olive cake, vermicomposted olive cake and manure were 42, 29 and 11, respectively. Both the unprocessed olive cake and vermicomposted olive cake immobilized soil N throughout the study duration of 91 days. Cattle manure mineralized an appreciable amount of N during the study. The prolonged immobilization of soil N by the vermicomposted olive cake was attributed to the C: N ratio of 29 and to the recalcitrant nature of its C and N composition. The results suggest that for use of vermicomposted dry olive cake as an organic soil amendment, the management of vermicomposting process should be so adjusted as to ensure more favorable N mineralization-immobilization.

Karmegam and Daniel ( 2000) conducted an experiment on the effect of biodigested slurry and vermicompost on the growth and yield of cowpea (*Vigna unguiculata*).The results showed that the fresh and dry matter yields of cowpea (*Vigna unguiculata*) were higher when soil was amended with vermicompost than with biodigested slurry.

Marinari *et al.* (2000) conducted a study on the influence of organic and mineral fertilizers on soil biological and physical properties. The results indicate that it increases macropore space ranging from 50 to 500  $\mu\text{m}$ , resulting in improved air-water relationship in the soil which favorably affects plant growth.

Sreenivas *et al.* (2000) studied the integrated effect of application of fertilizer and vermicompost on soil available nitrogen (N) and uptake of ridge gourd (*Luffa acutangula*) at Rajendranagar, Andhra Pradesh, India. The study concluded that soil available N increased significantly with increasing levels of vermicompost and highest N uptake was obtained at 50% of the recommended fertilizer rate plus 10 t /ha vermicompost.

De Kreij and Leeuwen ( 2001) conducted a study on the growth of pot plants in treated coir dust as compared to peat.They showed that cocopeat used alone, or as a component of soil medium, is suitable for many potted plants due to usual high initial level of potassium and sodium in cocopeat, the fertilization program should be adjusted carefully to plant requirements.

## **2.9 Planting Methods**

Cooper (1979) indicated that a typical layout of a hydroponic system is a series of troughs in which the crop is grown, a catchment tank containing the nutrient solution, circulation

pumps; a flow pipe delivering the nutrient solution to the upper part of the growing trough and the return pipe collecting the solution for return to the catchment tank. He also reported about various forms of troughs or gullies made from polyethylene and other rigid structures. Aluminium troughs have been used in more automated systems. The size and shape of the troughs are dictated by labour efficiency rather than engineering constraints.

Graves (1983) conducted a study on the nutrient film technique. The report indicated that all hydroponic systems are categorized with respect to how the nutrient solution is used, as either “closed” where the nutrient solution is recirculated, or “open” where the nutrient solution is not recirculated. A common practice with a closed system is to use nutrient solution for one or two weeks before replacing it. Usually additional fertilizers are added during this period to ensure that sufficient nutrients are available to the plants. The recirculated nutrient solution is continuously changing in nutrient composition due to plant uptake and by the evapotranspiration of water from the solution. The successful commercial application of closed hydroponic system is more dependent on good knowledge of plant needs for water and nutrients than open systems. Nutrients can build up to excessive levels which are toxic to plants or be depleted to extremely low levels if not supplied at concentrations analogous to plant needs.

Jensen and Collin (1985) reported that in most cases hydroponic systems are enclosed inside greenhouses or shade nets in order to provide some temperature control, to reduce evaporative water loss, to better control diseases and pests and to protect the crops against the elements of weather such as wind and rain.

Kozai (1988) cited that active protected cultivation with a range of sophisticated systems of environmental control like forced ventilation, evaporative or mechanical cooling, heating by means of warm water circulation or electric heating, carbon dioxide enrichment and artificial lightning can be used. Automated computerized environmental control systems are also used. Disadvantages are the cost of such systems, complicated management and risk of loss when the system malfunctions.

Burrage (1992) showed in his study that the vine crops such as tomatoes usually are grown in troughs wide enough for ease in pruning, training and harvesting. A close control should be kept on the materials used throughout the systems to ensure they are non-phytotoxic.

Polyethylene, rigid PVC and Polypropylene appear to have little phytotoxicity, whereas problems have been experienced with flexible PVC and butyl rubber. Copper and galvanized zinc piping should not be used as both elements accumulate in solution, rapidly reaching toxic level.

Olympion (1992) reported that hydroponic culture is gaining importance for the production of protected vegetable crops and ornamental plants.

Hutton (1999) reported that due to the high capital cost per square meter of protective environment structures, vertical layer systems may be viable option, especially for crops with relatively small plants like strawberry and lettuce. A small, inexpensive protective structure with a vertical hydroponic system may be a viable vegetable production enterprise for small-scale growers, provided the technical operation can be simplified. Various vertical systems are possible ranging from horizontal NTF troughs stake above each other to small containers arranged vertically. Relatively inexpensive containers made from PVC plastic tubes divided into a number of pockets are commercially available. Such tubes are typically suspended over a cable or beam, providing up to eight planting positions on both sides.

Despommier (2010) reported that aeroponics takes water conservation even further than hydroponics. Aeroponics requires no substrate to operate. With this technology, plants are grown with their roots suspended in a deep air or growth chamber while periodically sprayed with a fine mist of nutrient solution. Aeroponics provides excellent aeration to the roots and takes water conservation even further than hydroponics as it can operate with up to 70% less water than hydroponic technologies.

Ellis (2012) showed that hydroponics is a soilless culture where plants are grown using a mineral nutrient solution instead of soil. In hydroponics plants are grown with their roots either directly in the nutrient solution or in a supporting medium such as sand, gravel, perlite or other. Soil is now no longer required for plants to grow and thrive. Experience has proven that plants grown using hydroponics have shown to grow at a faster rate, ripen earlier and produce up to ten times the yield than that of soil-grown plants as well as providing a greater nutritional value.

### **2.9.1 Green Walls**

Johnson and Newton (2004) cited that some plants are able to grow on walls by taking root in the substance of the wall itself. Typical of these are the small herbaceous species such as ivy-leaved toadflax, wall flower and plants such as mosses, lichens and grasses. But other species are naturally adapted to climbing up and over obstacles such as rock faces, trees and shrubs. For these to grow successfully on walls and buildings some kind of support structure is usually essential.

Yeh (2012) reported that the green wall with the name vertical garden can absorb heated gas in the air, lower both indoor and outdoor temperature, providing a healthier indoor air quality as well as a more beautiful space.

### **2.10 Different methods of gardening**

Masabni (2009) conducted a study on vegetable gardening in Containers. The result concluded that containers that can be used for vegetable gardening range from ceramic and terracotta pots to whiskey barrels and cattle troughs with a stake attached to the outside of the container, or in the ground next to it.

Destia and Ophardt (2013) conducted a study on straw bale gardening and reported that the straw bales are best-suited for crops that grow to a medium height and develop a relatively deep rooting system, such as tomatoes, peppers, eggplant, squash, melons, and herbs. Potatoes and other vegetable crops that have the edible portion below ground are not well-suited for growing in straw bales. Tall crops such as corn do not work well in straw bales because the plants will fall over.

### **2.11 Irrigation systems used in vertical farming**

Kuang and Cliff (2008) developed an automated conveyer belt system that advances aquaponics. This unique prototype carries floating trays of plants past sunlight and nutrient dispensers. Under the plants swim tilapia fish, whose ammonia-laden waste descends to the gravel bed so bacteria can convert it to nitrogen. This acts as a natural fertilization to the plants from the fish. Finally, nitrogen-rich water is given to the plants, which take the nitrogen and

return clean water to the fish. Not only will this system increase yields, but it will also produce fresh crops and fish year round.

Despommier (2010) reported that cities are the biggest consumers of drinking water turning it into liquid municipal waste. This waste water is treated in a series of steps to remove solids and disarm it's potential to cause diseases after which it is simply let out into the nearest body of water. US cities collectively spend billions of dollars each year disposing of liquid municipal waste. This linear way of using water is a waste of both economic and environmental resources. In this scenario, instead of discarding the treated waste water, it would be used as irrigation water in standalone vertical farms.

Agrihouse (2011) showed that growers choosing to employ the aeroponics method can reduce water usage by 90%, fertilizer usage by 60%, all while maximizing their crop yields by 45 to 75%. Approximately 217,000 liters of water are required by the system per day out of which about 14,000 liters are assimilated and leave the tower within products and waste. The extra water that is not absorbed by the plants is directly re-circulated in the water-recycling system to be processed and sprayed again, thereby closing the loop.

Ellis (2012) conducted a study on agricultural transparency reconnecting urban centers with food production. The study reported that one of the biggest advantages of growing in controlled environments as in vertical farming compared to outdoor farming is that the water can be recovered. For example, water lost through transpiration and evaporation can be collected and thus reused.

## **2.12 Climatic influence of vertical farming**

Givoni (1976) cited that the need to re-apply finish surface materials or cladding, the loss of space resulting from thicker walls and the interruption of usage during construction can all be avoided through the use of vertical gardens. In fact, insulation applied to the exterior of buildings is much more effective than interior insulation, especially during the summer months.

Minke and Witter (1982) reported substrate depth of 20-40 cm can hold 10 – 15 cm of water, translating into runoff levels that were 25% below normal. A grass covered roof with a 200-400mm (8-16in.) layer of substrate can hold between 100-150mm (4-6in.) of water.



Gaudet (1985) found that a 10° F reduction in the outside air temperature achieved through the judicious arrangement of shade trees (green roofs and vertical gardens), can reduce energy consumption for air-conditioning by 50-70%.

Abernathy (1988) conducted a study on roof spray cooling system and showed that if vegetation is situated so as to cover building surfaces then evaporative cooling can reduce the need for air conditioning by reducing the air temperature immediately adjacent to the building. Artificial evaporative cooling systems have been shown to reduce air conditioning by 20-25%.

Wilmers (1988) indicated that in Germany, the vertical garden surface temperature was 10 °C cooler than a bare wall when observed at 1:30 PM in September.

Holm (1989) conducted a study on thermal improvement by means of leaf cover on external walls. The result showed that for a building consisting of two 10mm fiber-cement sheets with 38mm of fiberglass insulation, a computer simulation estimated that a vertical garden reduced summer daytime temperatures on the surface by 5 °C. These results are not as dramatic as the cooling effect on a horizontal surface, such as a roof, but given the amount of wall space in urban areas, the potential impact of vertical gardening is expected to be quite dramatic.

Liesecke *et al.* (1989) reported that under a green roof, indoor temperatures (without cooling) were found to be at least 3-4°C (5-7°F) lower than hot outdoor temperatures between 25-30°C (77-86°F).

Mc Pherson *et al.* (1989) concluded in their study that vegetation can reduce the use of air conditioning through shading and insulating a surface. In previous tests, it has been estimated that shading from trees might reduce energy usage from 20 – 30%.

Hooker and Hendricks (1994) showed that a 12 cm layer of substrate can reduce sound by 40 dB and a 20 cm can reduce sound by 46 dB (with some reductions as high as 50 dB).

Hoffman (1995) indicated in his study that micro climates are site-specific; for example, a rooftop will often have a different microclimate from the grade surrounding the building. Microclimate is directly influenced by a variety of elements on and around the site - land contour, vegetation, water, soil conditions, and buildings - which affect the site's sunniness,

warmth or coolness, humidity, wind, snowdrift and runoff patterns and degree of wind chill. By manipulating these site elements, the microclimate of a site can be substantially changed.

Christian and Petrie (1996) experimented that a vegetated roof of 0.46-0.76m (1.5-2.5ft.) of soil reduced the peak sensible cooling needs of a building by about 25%. In addition, the green roof did not have a cooling penalty like commercial buildings with high roof insulation levels.

Johnston and Newton (1996) showed that people living in high-density developments are known to be less susceptible to illness if they have a balcony or terrace garden due to the additional oxygen, air filtration and humidity control supplied by plants.

The studies conducted by Stifter (1997) in Berlin showed that rooftop gardens absorb 75% of precipitation that falls on them, which translates into an immediate discharge reduction to 25% of normal levels. Generally, summer retention rates vary between 70-100% and winter retention between 40-50%, depending on the rooftop garden design and the weather conditions.

Taha *et al.* (1997) conducted a study on urban climates and heat islands. The study concluded that vegetation will reduce energy emissions through reductions in the urban heat island, through shading windows from direct sunlight and through insulation from in both the winter and summer. Reducing energy usage directly on a particular building will reduce emissions of many pollutants into the atmosphere, but the indirect effect of reducing the urban heat island will also have an impact on urban air quality. In Southern California, simulation models have suggested that reducing the urban heat by 2° C would be equivalent to converting half of the motor vehicles to zero-emission electric engines.

Mercier (1998) reported that green roof and vertical garden technologies can provide an effective and proven method for governments, companies and building owners to reduce these GHG emissions through direct shading of individual buildings, improving insulation values and reducing the urban heat island effect.

Palomo (1998) conducted a study on analysis of the green roofs cooling potential in buildings. The computer simulation of green roofs indicated that they could improve the thermal performance of a building by blocking solar radiation and reducing daily temperature variations and annual thermal fluctuations or by reducing heat flux through the roof.

Sailor (1998) reported that a lower fraction of vegetative cover in the city reduces the available moisture to direct incoming solar radiation towards evapotranspiration. The non-vegetated surfaces absorb the incoming solar radiation and reradiate it as heat. This heat artificially elevates urban temperatures, a phenomenon known as the urban heat island. The study also showed that a significant reduction in the urban heat island could be achieved in the Los Angeles basin with a 1% increase in vegetation.

Thompson (1998) reported that in Portland a 100mm (4in.) green roof could absorb a full inch of rainfall during a summer rain event (when the soil started out fairly dry) before water started to runoff. This stormwater retention potential of rooftop gardens has led to a bonus density incentive programs in Portland for developers who install a green roof. Similar statistics do not exist for vertical gardens, but it would vary by design.

Groom *et al.* (2005) reviewed that one of the major benefits of vertical farming in urban centers is the gradual repair of these ecosystems. Translocation of food production to vertical farms would relieve the land currently used for agricultural purposes allowing for large scale ecosystem restoration. In many cases all it would take is simply abandoning the land and given time, nature will repair itself. Ecosystem regrowth will increase nature's own buffering capacity, resilience and resistance to disturbance and pollution, increase biodiversity and carbon sequestration to name a few. Restoring ecosystem functions and services might very well be one of the most potent means we have to turn the negative spiral of climate change around, opening up the possibility of a brighter, cleaner and less polluted future.

Ellis (2012) reported that the architecture of the VF building is a key as it can be constructed to optimize light input according to seasonal and daytime variation as well as taking advantage of the simple laws of physics to maximize climate control and ventilation without the use of external power sources needed. However, regardless of how optimal the architecture is fitted, extra lighting and climate control will most likely be needed.

## **2.14 Cultivation in Vertical Farming**

Germer *et al.* (2011) found that a controlled environment is unaffected by seasonal variation, opening up the possibility of multiple harvests a year, compared to outdoor farming that's typically restricted to a single harvest a year this is a dramatic increase of production

output potential. In a controlled environment the grower will be unaffected by weather fluctuations, drought and floods, avoiding the frequent loss of crops due to these factors commonly seen in outdoor agriculture.

Alexandratos and Bruinsma (2012) reported that by the application of vertical frames and multiple stacks, the basic ground area of the building (2500 m<sup>2</sup>) is increased 37 times to an expanded plant area to a total of 92,718 m<sup>2</sup>, comprising of a total of 116 stacks through 25 floors. This results in a total production of 3,573.41 tons of edible plant biomass. However, for this only 2500 m<sup>2</sup> is being used, so if we grew all those crops proportionately on the same 2500 m<sup>2</sup> this means multiplication of the yields by a factor of 516. This makes Vertical Farming a viable candidate, at least theoretically for our race to multiplying the food production by 60% by 2050.

Chirantan Banerjee (2013) indicated that among the cultivated crops tomatoes, potatoes and pepper were gave higher yield (155tons/ha, 150 tons/ha, 133 tons/ha respectively) under VF than field yield (45 tons/ha, 28 tons/ha, 30 tons/ha respectively).

### **2.13 Crop selection**

Calvert (1973) in his study on morphology and development of tomatoes reported that tomato is daylength insensitive or photoperiodically day neutral in its flowering habit.

Mobayen (1980) conducted a study on germination of citrus and tomato seeds in relation to temperature and found that more rapid germination has been observed with smaller seed.

Kaloo (1986) conducted a study on tomato and found that the plant requires 3 to 4 months of seedling to produce the first ripe fruit.

Resh (1993) conducted a study on hydroponic tomatoes for the home garden. He reported that tomato seedlings should be transplanted into their permanent positions when they have 3 to 4 true leaves and their roots have penetrated the growing cubes in the seedling trays.

Lacutus and Tanasescu (1995) reported that the optimum temperature for germination ranges from 18 °C to 26 °C. Temperature above 34 °C during the daytime, and above 40 °C for longer than four consecutive hours, cause flower abortion. At low temperature there is slow or

reduced germination. A difference of 5 °C to 8 °C between day and night temperature improves germination, growth and development, flowering and yield.

Priya *et al.* (2007) reported that amaranths have excellent nutritional value because of their high content of essential micronutrients such as b-carotene, iron, calcium, vitamin C and folic acid.

Schippers (2004) recommended the application of compound fertilizer NPK 10-10-20 at a rate of 400 kg/ha for amaranthus. He also mentioned that frequent irrigation is essential in the case of a rapid growth and late flowering.

Sally Cunningham (2010) reported that the growth of amaranthus ceases at temperatures below 18 °C.

## **MATERIAL AND METHODS**

## **MATERIALS AND METHODS**

This chapter describes the materials used and the methods employed for the project under the title “Fabrication and Performance Evaluation of Vertical Farming Structure for Homesteads” conducted in flats of Kelappaji College of Agricultural Engineering and Technology, Tavanur, Malappuram, Kerala.

### **3.1 Location of Study**

The experiment was conducted in the KCAET, Tavanur, in Malappuram district, Kerala. The place is situated at 10° 52' 30" North latitude and 76° East longitude. The total area of KCAET is 40.99 ha, out of which total cropped area are 29.65 ha. Agro climatically, the area falls within the border line of Northern zone and Central Zone of Kerala. Major part of the rainfall in this region is obtained from South West monsoon. The area is having a relative humidity of about 62%. The mean maximum temperature of the area is about 42.1 °C and mean minimum temperature of the area is about 22°C.

Two of the balconies of the flat in KCAET, Tavanur facing west were selected for the installation of VF structure and for potted cultivation. The two selected balconies are at the same floor and receiving almost similar amount of solar radiation. The flat balcony has a dimension of 2.2m×0.85m and having a possible height of cultivation with adequate reach of sunlight as 2.2m. The material required for the study is given below in Table 3.1. The experiment was conducted during November 2014 to January 2015.

### 3.2 Fabrication of VFS

Mild steel tubes and rods of different dimensions were used for making the frame of the structure. Half splitted PVC pipes of 6 inch diameter were used as the trough for growing the crops. A total number of 19 half splitted PVC pipes were placed in the frame of a three tier system. The material required for the fabrication of the VFS is shown in the Table 2

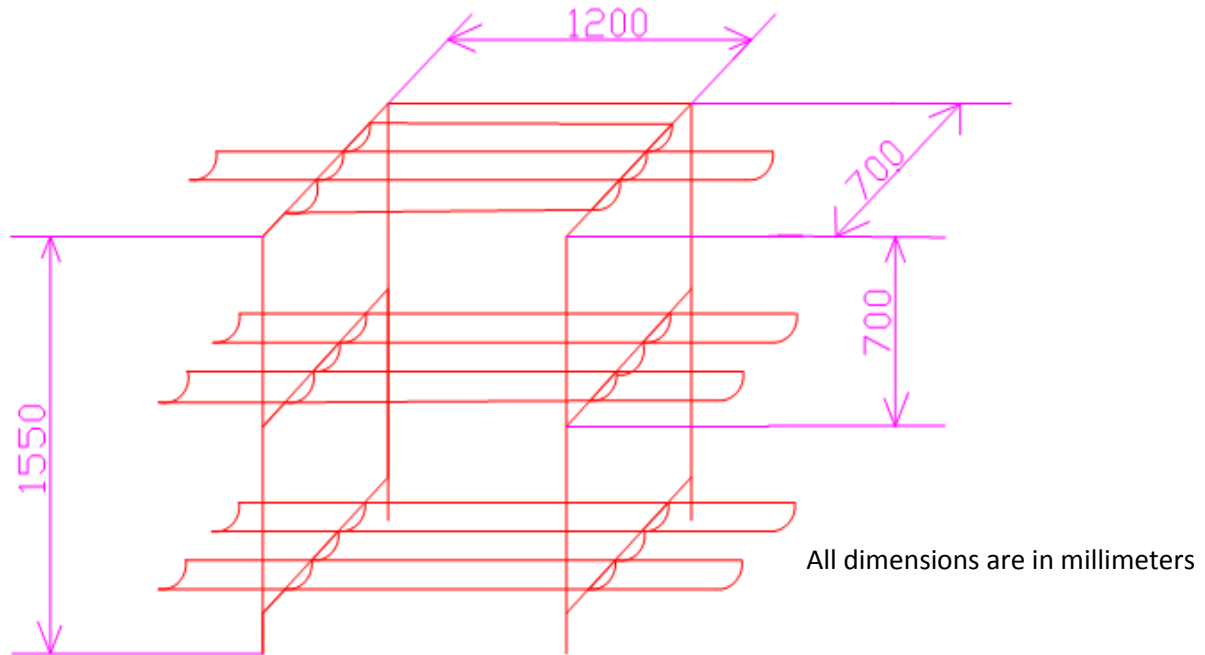
**Table 2. Materials used for construction of VFS**

<b>Material</b>	<b>Quantity</b>
1½ " Square Tube	15 m
½ " Square Tube	20 m
¾ " x ⅛ " Flat	20 m
P V C Pipe( 6 inch)	12 m
¼ " M S Rod	4 m
¼" × 2½" Nut and Bolts ,Washer	24 No
Emery Paper	2 sheets
Metal Primer	500 ml
Paint	500ml
Cocopeat	9 Kg
Vermicompost	5kg
Cowdung powder	5 Kg



### 3.2.1 Experimental setup

The balcony has a dimension of 2.2m×0.8m. The possible height of balcony with an adequate reach of sunlight was about 2.1m. The fig. 1 is showing the fabricated vertical farming structure with specification



**Fig. 1 Fabricated Vertical Farming Structure (VFS)**

The row width of each tier of VFS was designed as per the available possible width of the balcony. The width of the balcony was 0.85m, so the VFS is fabricated with a width of 0.70m by leaving a gap of 15cm for the movement of a person for looking after the plants. In each of the three tiers three rows were provided, with each row about 20cm in width.

The available length of the balcony was about 2.2 m leaving the door, so the length of the middle rows in VFS was designed as 1.2 m and the length of the side rows were fixed as about 50 cm each.

The possible height with adequate sunlight and reach ability of an average height person is about 1.5m. According to this height the height of the structure was fixed. Three tiers were

included with a gap of about 70cm in between. The bottom tier is set at a height of 10cm above the floor for easy cleaning of the floor and for proper air circulation.

### **3.2.2 Placing of VFS**

By considering the dimension the structure was placed in the balcony leaving a gap of about 25cm in the width for movement of a person for managing the plants.

Half splitted PVC pipes of 6 inch diameter were selected. Half splitted PVC pipes (with caps on both sides) of 2.80 mm wall thickness and 1.2 m length were provided in the middle rows. Half splitted PVC pipes (with caps on both sides) of 50cm length were provided in the side rows. The PVC splits are supported by semicircular rings made of 3/4"× 1/8" flat in each rows which were welded to the 1/2" square tubes. The PVC troughs were filled randomly with the rooting media as shown in Plate1.

### **3.2.3 Arrangement done for potted cultivation**

The flat balcony with the above specified dimension of 2.2m × 0.8m was selected for potted cultivation. As per the dimension of the balcony about 30 pots with top diameter of about 15.5 cm and base diameter of about 7cm could be placed in the floor of the balcony with ten pots on three rows. A gap of about 15cm was provided in between the rows. The rooting media were filled as per the treatments T1, T2 and T3 in each ten pots and were arranged randomly in the balcony of the flat as shown in Plate 2.

## **3.3 Field experiment**

### **3.3.1 Treatment details**

Different rooting mediums were used as different treatments in this study. These were filled in half splitted PVC pipes in VFS and in pots. The different treatments used for the study were shown in table 3.

**Table 3. Different treatments used for the study**

<b>Treatment</b>	<b>Components</b>	<b>Ratio</b>
T1	Cocopeat + cowdung powder	3:1
T2	Cocopeat + vermicompost	3:1
T3	Cocopeat + cowdung powder + vermicompost + soil	2:1:1:4

### 3.3.2 Layout of experiment

The experimental layout for the VFS and potted cultivation are shown in fig.2 and fig.3 respectively.

	<b>T1</b>	<b>T1</b>	<b>T2</b>	<b>T3</b>	<b>T2</b>	
<b>T2</b>	<b>T3</b>	<b>T3</b>	<b>T1</b>	<b>T2</b>	<b>T3</b>	<b>T2</b>
<b>T2</b>	<b>T3</b>	<b>T2</b>	<b>T3</b>	<b>T1</b>	<b>T3</b>	<b>T2</b>

**Fig. 2 Experimental layout for Vertical Farming Structure (VFS)**



**Plate 1. VFS placed in the balcony of flat, KCAET**

<b>T1</b>	<b>T2</b>	<b>T1</b>
<b>T2</b>	<b>T1</b>	<b>T3</b>
<b>T3</b>	<b>T2</b>	<b>T1</b>
<b>T2</b>	<b>T1</b>	<b>T3</b>
<b>T1</b>	<b>T2</b>	<b>T3</b>
<b>T2</b>	<b>T3</b>	<b>T1</b>
<b>T3</b>	<b>T2</b>	<b>T1</b>
<b>T2</b>	<b>T3</b>	<b>T1</b>
<b>T1</b>	<b>T3</b>	<b>T2</b>
<b>T3</b>	<b>T2</b>	<b>T3</b>

**Fig .3 Experimental layout for potted cultivation**



**Plate 2. Arrangements of pots in the flat balcony, KCAET**

### **3.3.3 Rooting media filling in half splitted PVC pipes/Pots**

Three rooting media were prepared for comparing the performance of plants in VFT and potted cultivation. The rooting media were prepared by mixing cocopeat, cowdung powder, vermicompost and soils in various proportions. Cocopeat is the spongy, peat like residue from the processing of coconut husks (mesocarp). It consists of short fibres (<2cm) around 2% - 13% of the total and cork like particles ranging in size from granules to fine dust. Coir dust strongly absorbs liquids and gases. This property is due to the honeycomb like structure of the mesocarp tissue which gives it a high surface area per unit volume. Coir dust is also hydrophilic (attracts water) which means that moisture spreads readily over these surfaces. The extensive film of water that is produced gives moist coir the capacity to absorb air and other gases (odours). Cocopeat has moisture content of about 13%, pH of 5.1 and an electrical conductivity of

0.80Ds/m. It consists of about 0.5% Nitrogen, 0.3% Phosphorous, 0.4% Potassium and 0.07% Chlorine by weight. Table 3. shows the properties of different rooting media.

**Table. 4 Properties of rooting media**

Material	Moisture(%)	H	EC(dS/m)	N(%DWt)	P(%DWt)	K(%DWt)	Cl(%DWt)
Coir dust	13	.1	0.80	0.5	0.3	0.4	0.07
Sphagnum peat	9	.3	0.85	0.9	0.5	0.1	0.05
Sedge pat	83	.9	0.35	0.9	0.5	0.1	0.05

Vermicompost is rich in microbes and plant growth regulators, and fortified with pest repellence attributes. The vermicompost provides all nutrients in readily available form and also enhances uptake of nutrients by plants. The nutrient elements of vermicompost are shown in Table. 4

**Table. 5 Nutrient Elements of vermicompost**

Nutrient Element	Vermicompost (%)
Organic Carbon	9.8-13.4
Nitrogen	0.51-1.61
Phosphorus	0.19-1.02
Potassium	0.15-0.73
Calcium	1.18-7.61
Magnesium	0.093-0.568
Sodium	0.0058-0.158
Zinc	0.0042-0.110
Iron	0.2050-1.3313
Manganese	0.0105-0.2038
Copper	0.0026-0.0048

First rooting media (T1) is prepared by mixing cocopeat and cowdung powder in 3: 1 ratio. Second rooting media (T2) prepared by mixing cocopeat and vermicompost in 3: 1 ratio. Third media (T3) prepared by mixing cocopeat, vermicompost, cowdung powder and soil in 2: 1: 1: 4 ratio.

T1, T2 and T3 were filled in one of the three rows in each tier as well as two of the side rows in the VFS. In potted cultivation T1, T2 and T3 were filled in each of the ten pots.

### 3.3.4 Selection of plants

Selection criteria are based on characteristics such as height of the plant, type of fruit, shape of plant, vitality and resistance to pests and diseases, but also on factors related to climate and management. Finally tomato and amaranthus were selected for the study. Seedlings of S-22 variety of tomato were taken for the first trial and Arun variety of amaranthus were taken for the second trial.

Tomato (*Lycopersicon esculentum*) belongs to the Solanaceae family. Tomato is a short lived perennial grown as an annual crop. Growth can either be determinate or indeterminate. Tomato is a warm season crop but it can be produced in cold climates under protection. Tomato requires a relatively cool, dry climate for high yield and premium quality. However, it is adapted to a wide range of climatic conditions from temperate to hot and humid tropical. The optimum temperature for most varieties lies between 21 and 24 °C. The plants can survive a range of temperatures, but the plant tissues are damaged below 10 °C and above 38 °C. The temperature requirement of tomato during the growth cycle is showing in the Table. 5

**Table. 6 Temperature requirement of tomato**

Stages	Temperature (°C)		
	Minimum	Optimum Range	Maximum
Seed germination	11	16-29	34
Seeding growth	18	21-24	32
Fruit set	18	20-24	30
Red colour development	10	20-24	30

Tomato grows well on most mineral soils that have proper water holding capacity and aeration, and are free of salt. It prefers deep, well-drained, sandy loam soils. The upper layer needs to be permeable. Soil depth of 15 to 20 cm is needed to grow a healthy crop. Tomato is moderately tolerant to a wide range of pH (level of acidity), but grows well in soils with a pH of 5.5 – 6.8 with adequate nutrient supply and availability.

Amaranth [*Amaranthus hypochondriacus*, *A. cruentus* (Grain type) and *A. tricolor* (Vegetable type)] is an herbaceous annual with upright growth habit, cultivated for both its seeds which are used as a grain and its leaves which are used as a vegetable or green. Both leaves and seeds contain protein of an unusually high quality. The grain is milled for flour or popped like popcorn. Amaranth is a valuable nutritious feedstuff with high production ability. The most optimal are humid and well-structured soils but the crop tolerates any soil conditions. Amaranth is thermophilous plant and especially for germination higher temperature of soil is necessary; otherwise older plants tolerate even short-term frost. This crop is resistant to drought thus it does not require as much moisture as other crops. The only exception is germination stage and first couple of weeks in growing season until strong root system is established. Dry and warm weather is welcome at harvest time to press losses of crop on minimum.

### **3.3.5 Planting methods**

Tomato seedlings of S-22 variety with 15 days old were used for the first trial. The seedlings of amaranthus for the second trial were of 7 days old. The seedlings were transplanted into the VFS as well as to the pots. The depth of the rooting media in the half splitted PVCs of VFS was about 9.5 cm and pots were provided with rooting media mixture of 14 cm depth. Four seedlings were transplanted in each middle row and two seedlings to each of the side rows in the structure with spacing of 30 cm. One plant was transplanted in each pot.

### **3.3.6 Irrigation and fertilizer application**

Irrigation was given manually at a rate of 100 to 200 ml per plant in VFS and 150 to 300 ml per plant in pots on daily basis. The fertilizer was applied at the rate of 3 to 5 g per plant in a single doze in both VFS and pots.



### **3.3.7 Observation of climatic parameters**

For comparing the performance of crops under two balconies, climatic parameters such as temperature, relative humidity were observed during morning, afternoon and evening for a period of three weeks after transplanting(1<sup>st</sup> week-17<sup>th</sup> November 2014 to 23<sup>rd</sup> November 2014, 2<sup>nd</sup> week-24<sup>th</sup> November 2014 to 30<sup>th</sup> November 2014, 3<sup>rd</sup> week-2<sup>nd</sup> December 2014 to 8<sup>th</sup> December 2014). For comparing the temperature of rooting media, this was observed three times a day from both balconies for a period of three weeks. The air temperature and relative humidity were observed using digital thermometer. The rooting medium temperature was observed with digital soil thermometer.

The daily observations were tabulated and the average values of observations of each week were noted and were used for plotting the graphs.

### **3.3.8 Biometric observations**

For analyzing the growth pattern of the crops, four plants were selected randomly from each rooting media in VFS as well as from potted cultivation. The parameters and procedures followed are given as follows. Biometric observations such as plant height, girth and number of leaves were made once in a week. The collected data were tabulated and compared separately for each trial.

#### **3.3.8.1 Height of the plant**

The heights of the randomly selected plants were measured from the surface of the rooting media to the tip of the plant.

#### **3.3.8.2 Girth of the plant**

The girth of the randomly selected plants grown under each rooting media mix of VFS and pots were taken once in a week. The measurements were taken from the bottom of the stem of each selected plants for a period of three weeks.

### **3.3.8.3 Number of leaves per plant**

Numbers of leaves of randomly selected plants of each rooting media were counted once in a week for a period of three weeks.

### **3.3.8.4 Yield (g/cm<sup>2</sup>)**

Harvesting of the crop was done after attaining maturity. The first yield was taken one month after transplanting.

## **RESULTS AND DISCUSSION**

## **RESULTS AND DISCUSSION**

The study has been undertaken with the objectives of fabrication of a VFS for homesteads, and to evaluate the performance of crops under VFS and potted cultivation in the balcony. Two trials were done for the study. For the first trial, tomato was selected as the crop. The climatological data were taken after the transplanting of tomato in VFS and in pots. The results of the study were discussed in this chapter.

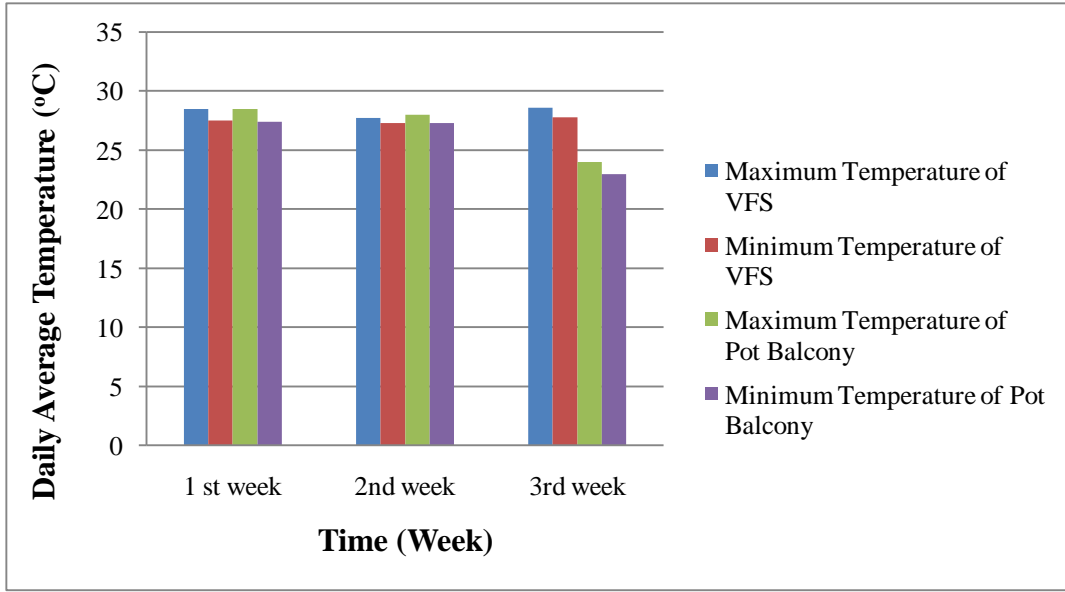
### **4.1 Comparison of climatic data**

Climatic parameters such as air temperature, relative humidity and rooting medium temperature were observed in the balconies of VFS and potted cultivation. The observations were noted at 8:00 am, 1:30 pm and 5:00 pm every day after transplanting for a period of three weeks. The observations were analyzed through climatic parameters in both the balconies.

#### **4.1.1 Air temperature**

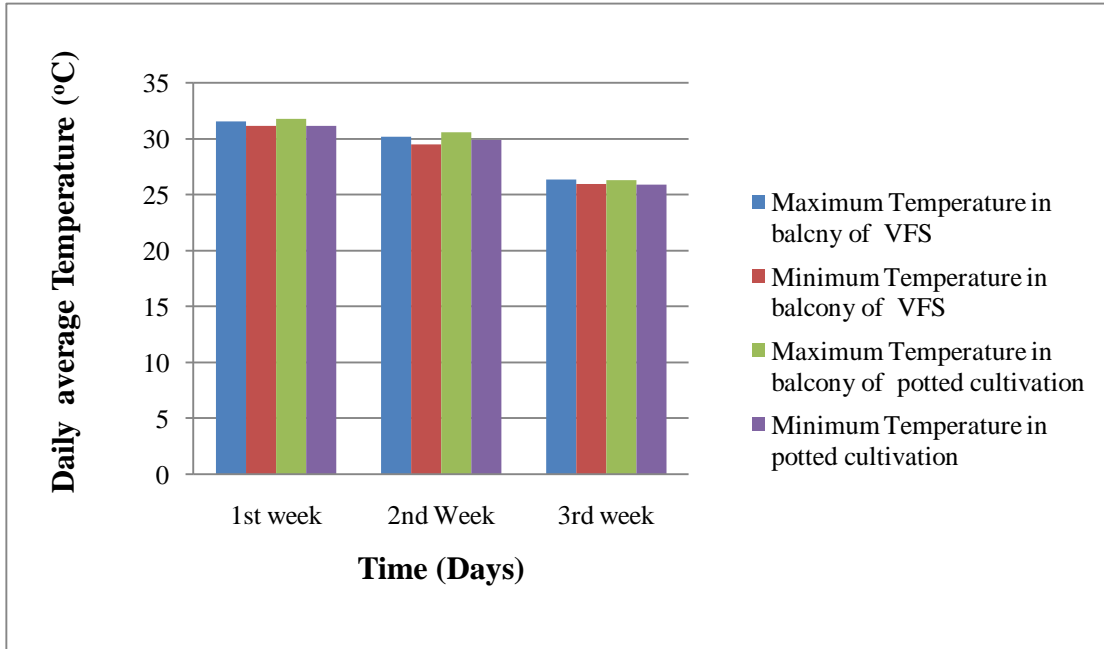
The weekly average values for air temperature was calculated for 8:00 am, 1:30 pm and 5:00 pm from the daily data taken. The variations of air temperature at 8:00 am in the balconies of VFS and potted cultivation is shown in Fig.4. Apart from the third week the maximum and minimum temperatures of both the balconies were almost the same. The maximum temperature noted in VFS balcony was 28.64° C and of pot balcony was 28.5° C. The minimum temperature observed was 27.7° C in VFS balcony and 24° C in pot balcony. This is because some of the reflected solar radiation was absorbed by the three tier metal frame during the day time. But in potted cultivation, reflected radiation was totally absorbed by the atmosphere. During the night time there may have the chance for transferring of heat from the metal frame to the surrounding atmosphere. Hence there is a small increase in the air temperature in VFS compared to pot in morning hours. At the end of the third week, after the full establishment of plants, a notable change was observed in the air temperature at 8:00 am between VFS and potted cultivation.

As a part of the respiration process at night hours heat was liberated by the plants. In VFS more plants are there compared to potted cultivation, hence there may be more temperature in the atmosphere near to VFS than in potted cultivation during morning hours.



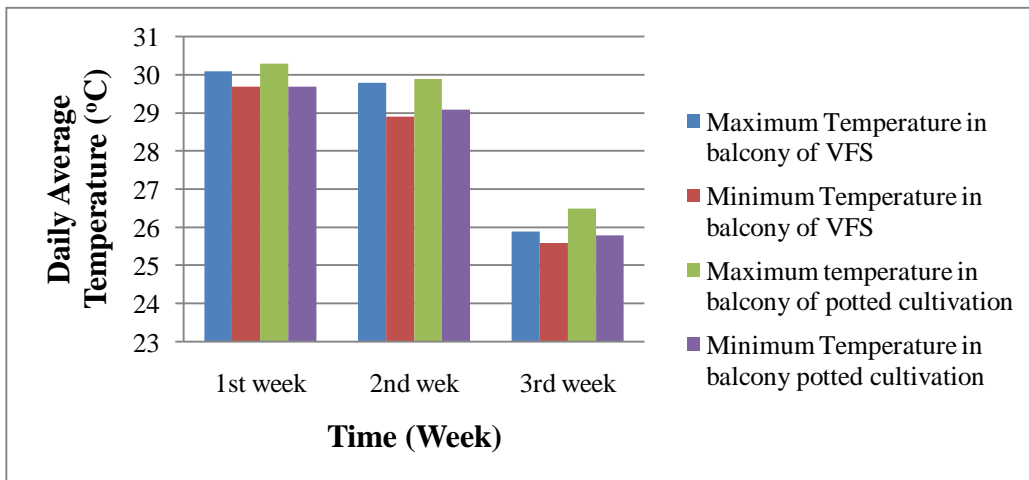
**Fig.4 Variation of Air Temperature in VFS and Potted cultivation at 8:00 am**

The observation of air temperature at 1:30 pm is shown in Fig.5. There is no significant variation in the maximum and minimum temperature of the two balconies. The maximum temperature observed in VFS balcony was 31.6° C and in potted cultivation was 31.8° C. The minimum temperature observed in the third week of observation with values of 26° C in both the balconies. In both VFS and potted cultivation maximum air temperature was observed at 1.30 pm. There is a small increase in air temperature in air temperature at first 2 weeks in potted cultivation. This is due to the reflection of solar radiation from the floor of the balcony. But in VFS, it may absorb some part of the reflected radiation. But in third week, both the VFS and in potted cultivation shows almost same air temperature. After the full establishment of plants, heat was absorbed by the plants.



**Fig.5 Variation of air temperature in VFS and potted cultivation at 1:30 pm**

Similarly the air temperature noted at 5:00 pm is shown in Fig.6 The maximum temperature noted is about 30° C and the minimum temperature was about 26° C in both the balconies. The graph showing the air temperature of VFS and potted cultivation at 5:00 pm also shows almost same trend as that of air temperature at 1:00 pm.

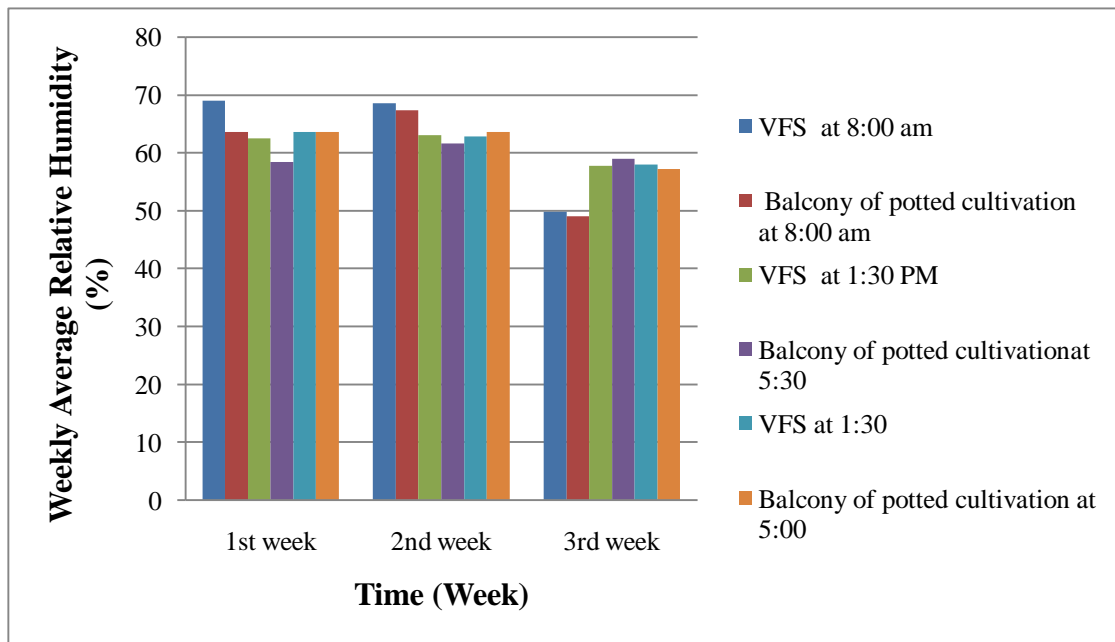


**Fig.6 Variation of air temperature in VFS and potted cultivation at 5:00 pm**

We can also observe that almost similar values of maximum and minimum temperature were in the balconies since both the balconies belong to the same floor. The maximum temperature in a day is observed at 1:30 pm. The highest temperatures were observed in the first week period and minimum in the third week.

#### 4.1.2 Relative Humidity

The weekly average values for relative humidity was calculated for 8:00 am, 1:30 pm and 5:00 pm respectively from the daily data taken. The values of relative humidity at 8:00 am, 1:30 pm and 5:00 pm for the three weeks is shown in the Fig.7. From the graph it is clear that the relative humidity is slightly more for the balcony of VFS even though the air temperatures are almost same. This is due to the cooling effect provided by the vertically grown plants in the balcony. The potted plants can contribute less compared to vertically grown plants in the structure for cooling the balcony. The highest values of relative humidity were observed in the morning time due to the cooling effects of plants combined with the least air temperature in the morning.



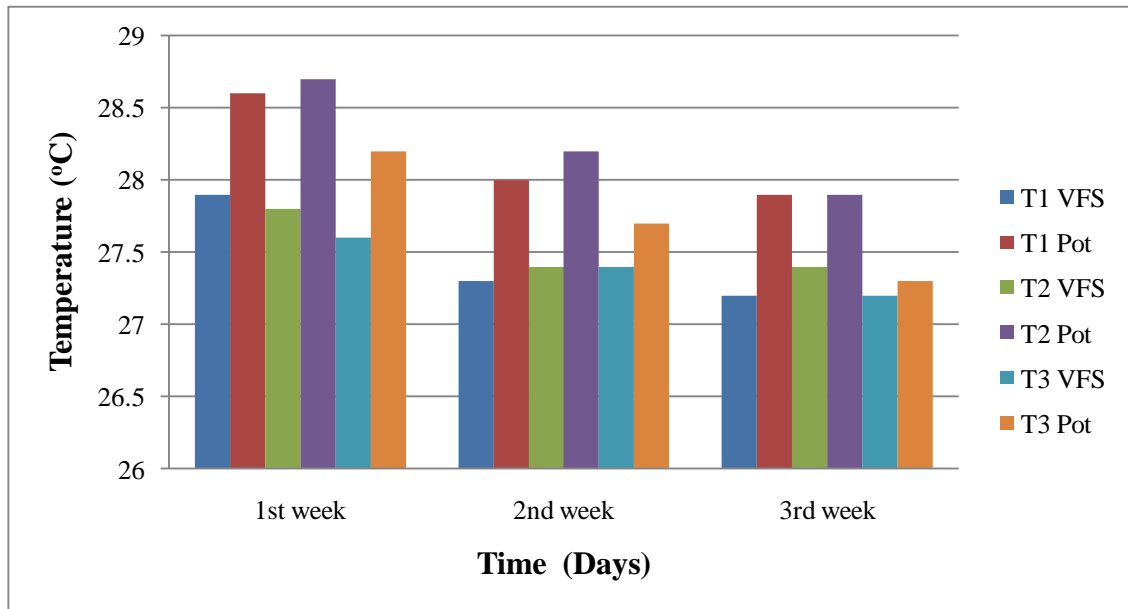
**Fig.7 Variation of Relative Humidity in VFS and Potted cultivation**

### 4.1.3 Rooting media temperature

The temperature of the three rooting media mixture were noted and separately tabulated for the three weeks. The graphs plotted with the weekly average values are shown in Fig.8, 9 and 10.

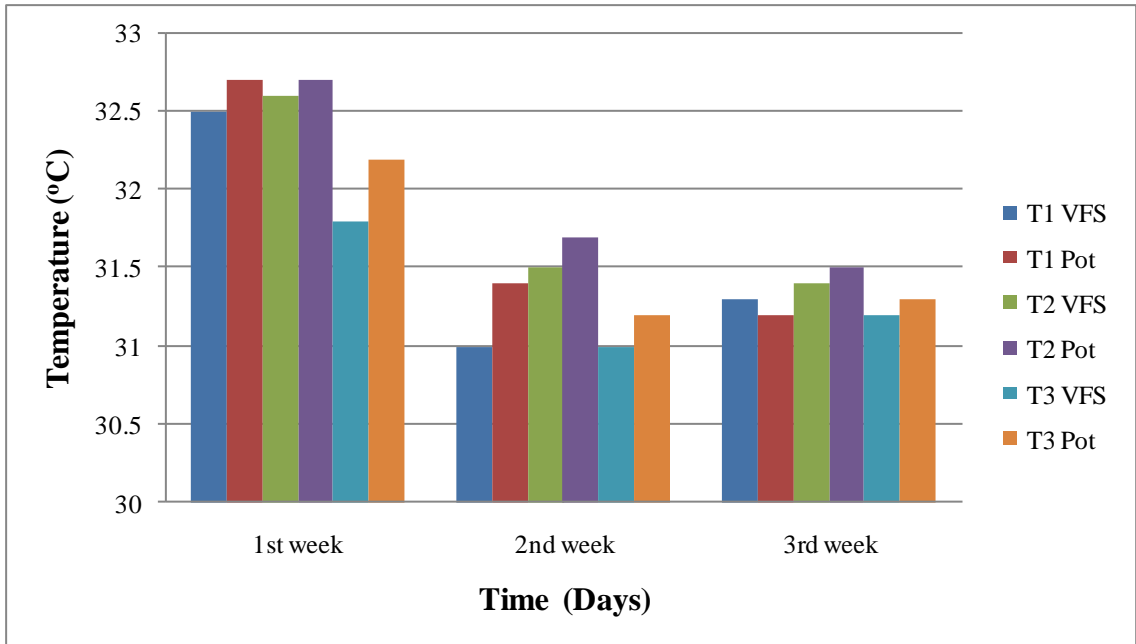
The temperatures of T1, T2 and T3 were more in the pots than in the VFS in all the three week period. In VFS, there is more chance of absorption of heat energy by the plants and the structure, hence rooting media temperature was less compared to potted cultivation and also at the same time evapo-transpiration is more in VFS due to more number of plants compared to potted cultivation. This is the cause of reduction in rooting temperature in VFS.

By comparing the three graphs we can find that the highest temperatures of all the mixtures in each week were observed at the afternoon (1:30 pm). There is no appreciable difference in the temperatures of the three media between weeks. The highest values were observed in the first week, i.e., rooting media temperatures follows the similar trend of air temperature. Therefore we can realize the fact that there is correlation with the air temperatures and the rooting media temperatures.

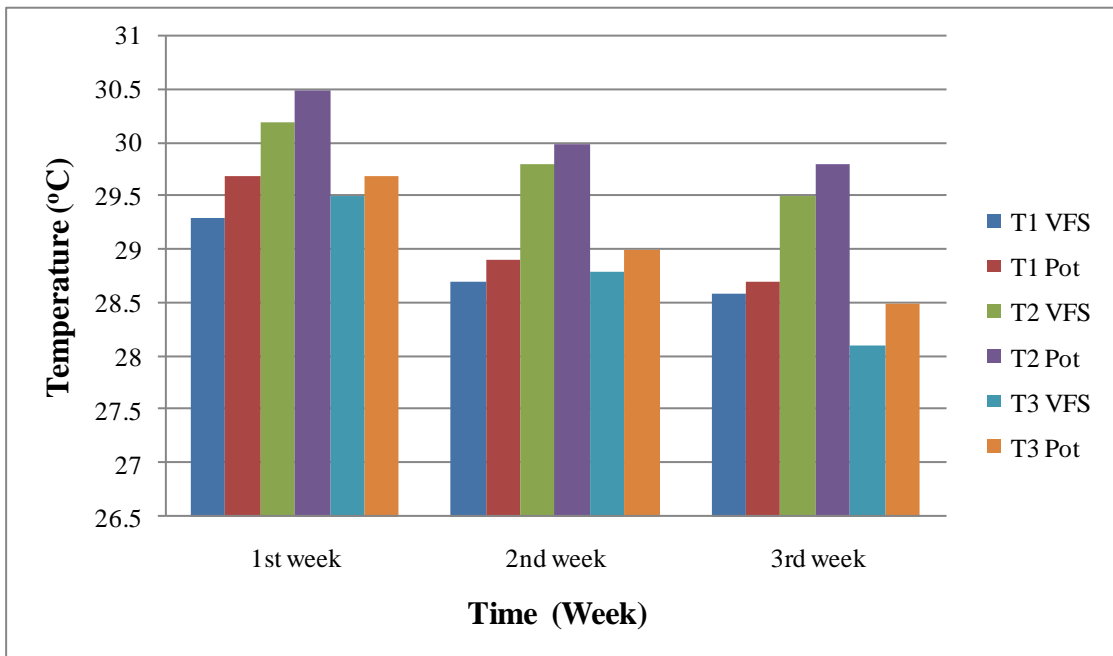


**Fig.8 Variation of rooting media temperature in VFS and potted cultivation at 8:00 am**





**Fig.9 Variation of rooting media temperature in VFS and Potted cultivation at 1:30pm**



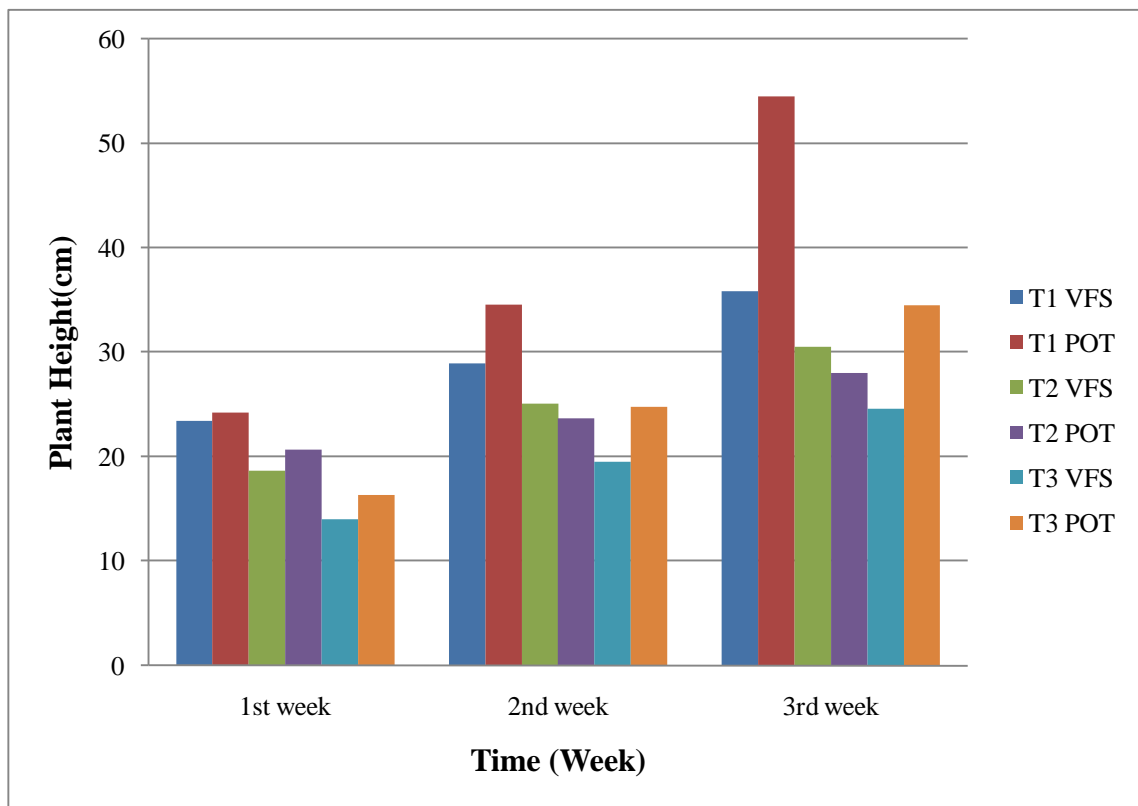
**Fig.10 Variation of rooting media temperature in VFS and potted cultivation at 5:00 pm**

## 4.2.1 Biometric observations for first trial (Tomato)

### 4.2.1.1 Plant height

The observations on height of the plants were first taken one week after planting. After that, the observations were taken in a weekly interval. The plant heights for T1, T2, T3 for the three weeks of VFS and potted cultivation is shown in the Fig.11

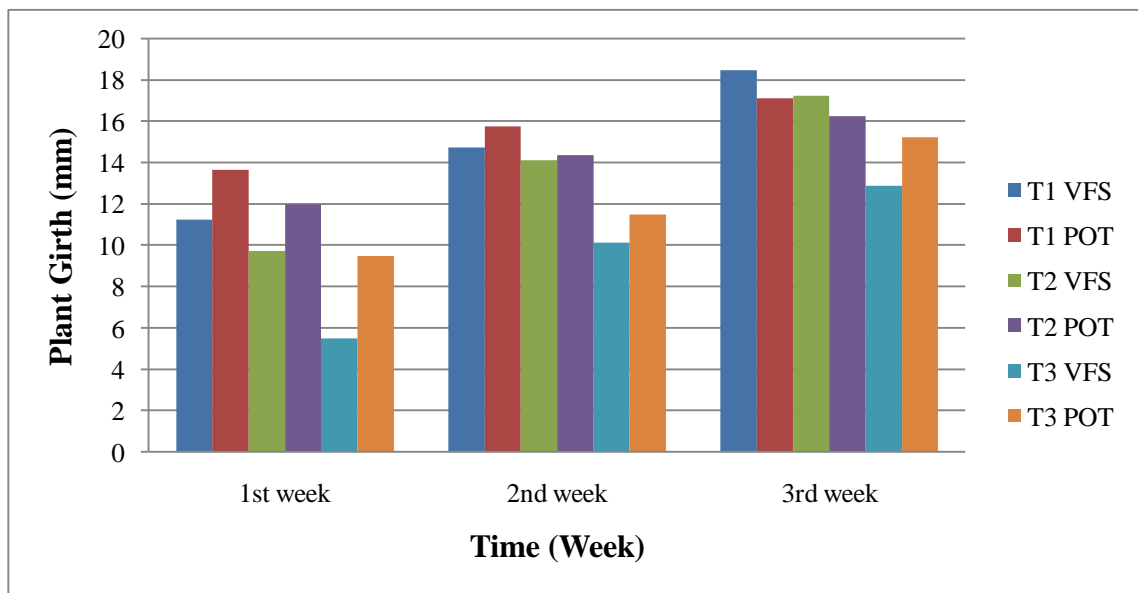
In first week, for all treatments plant height was more for potted cultivation. T1 of potted cultivation had the highest plant heights in each week (24.25 cm, 34.55 cm and 54.5 cm). In 2<sup>nd</sup> and 3<sup>rd</sup> week except T2 same trend is following for T1 and T3. But in the case of T2, in VFS shows an increase in height in second and third week. For T2 best performance of plant height were observed in the VFS.



**Fig.11 Variation of plant heights in different treatments of VFS and potted cultivation**

#### 4.2.1.2 Plant Girth

The observations on plant girth were first taken one week after planting. After that, the observations were taken in a weekly interval. For the first two weeks the girth of the plants was more in the potted cultivation. During the third week the girth of the plants in T1 and T2 of plants in VFS increased to a higher value than corresponding values for the plants in pots. Even though the girths were more for the potted cultivation in the first two weeks, the increase in the rate of girth is more for the VFS between successive weeks. For the first two weeks the highest values (13.625 mm and 15.75 mm) were observed for T1 of potted cultivation, but for the third week the T1 of VFS showed the highest value (18.5 mm). In terms of plant girth, T1 and T2 exhibit best performance under VFS. The plant girths for T1, T2, T3 for the three weeks of VFS and potted cultivation is shown in the Fig. 12

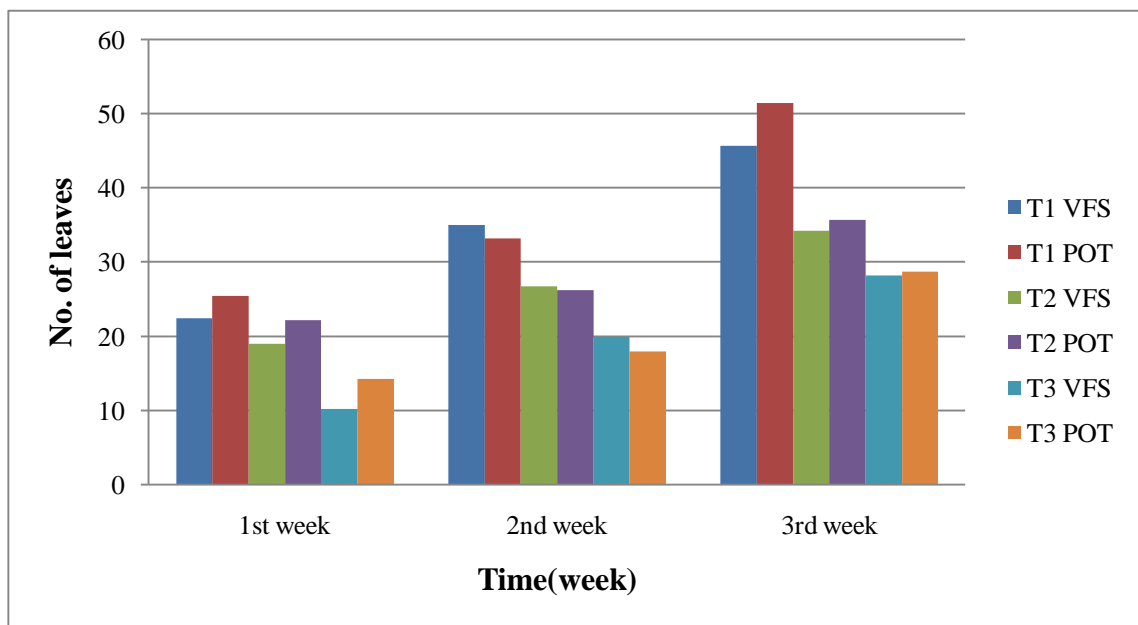


**Fig.12 Variation of plant girth in different treatments in VFS and potted cultivation**

#### 4.2.1.3 Number of leaves

The observations on number of leaves were first taken one week after planting. After that, the observations were taken in a weekly interval. For the first week, plants in potted cultivation had more number of leaves than the structure. During second week, there was a marked increase in the number of leaves for all the rooting media mixtures of VFS. But for the third week again

number of leaves became more for the potted cultivation. This may due to variation in the availability of sunlight. For the first and last weeks the highest number of leaves (23 and 52) observed in T1 of pot. For the second week T1 of VFS had the highest value (35). The T3 of VFS exhibits least performance in all the three weeks. The no. of leaves for T1, T2, T3 for the three weeks of VFS and potted cultivation is shown in the Fig. 13.



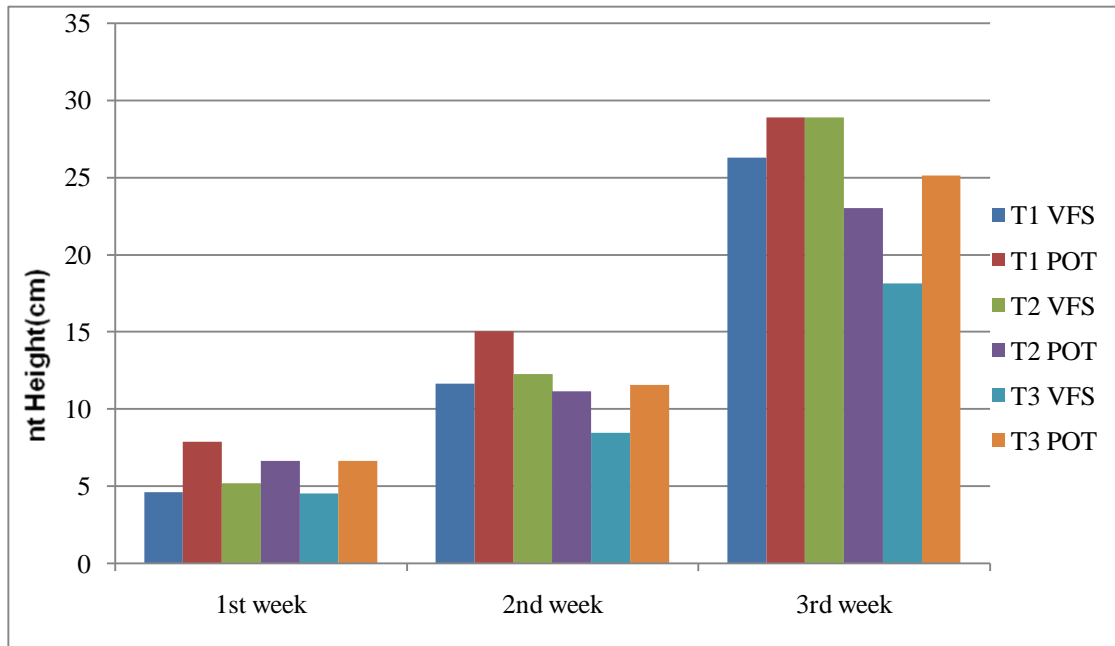
**Fig. 13 Variation of number of leaves in different treatments of VFS and potted cultivation**

#### **4.2.2 Biometric observations for second trial (Amaranthus)**

##### **4.2.2.1 Plant Height**

The observation on plant height was first taken one week after planting. After that, the observations were taken in a weekly interval. T1 and T3 had better performance under potted cultivation in each week. T2 showed highest values of plant height during the second and third weeks (12.25 cm and 28.825 cm). The best performance could be observed for T1 of potted cultivation in all the three week period (7.875 cm, 15.025 cm, 28.875 cm). But the percentage increase in the plant height is more for T1 of VFS followed by T2 of VFS. Plant heights of T1 of VFS (26cm) and T2 of VFS (29 cm) are comparable. The least performance could be observed

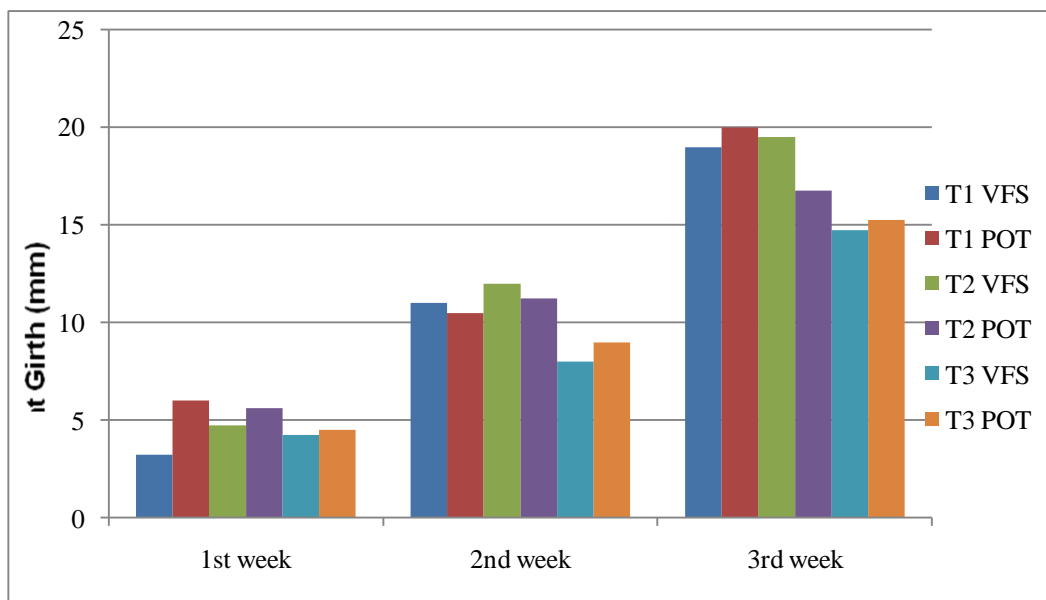
for T3 of VFS (4.5 cm, 8.425 cm, 18.125 cm). The plant height for T1, T2, T3 for the three weeks in VFS and potted cultivation is shown in the Fig. 14.



**Fig. 14 Variation of plant height in different treatments in VFS and potted cultivation**

#### 4.2.2.2 Plant Girth

The observation on plant girth was first taken one week after planting. After that, the observations were taken in a weekly interval. T1 and T3 had better performances in potted cultivation during the entire period of observation. T2 exhibits highest values in the VFS. The highest value for the plant girth was observed for T1 of pot (6 mm, 10.5 mm and 20 mm for first, second and third week respectively). The least plant girth was observed for T3 of VFS for all the weeks considered (4.25 mm, 8 mm, and 14.75 mm). Even though the highest girths were observed for the potted cultivation, the rate of rise in girth is more for the VFS between successive weeks. The percentage increase in girth of the plant is more for T1 of VFS followed by T2 of VFS. Girth of T1 of VFS (19 mm) and T2 of VFS (19.5mm) are comparable. The plant height for T1, T2, and T3 for the three weeks of VFS and potted cultivation is shown in the Fig. 15.

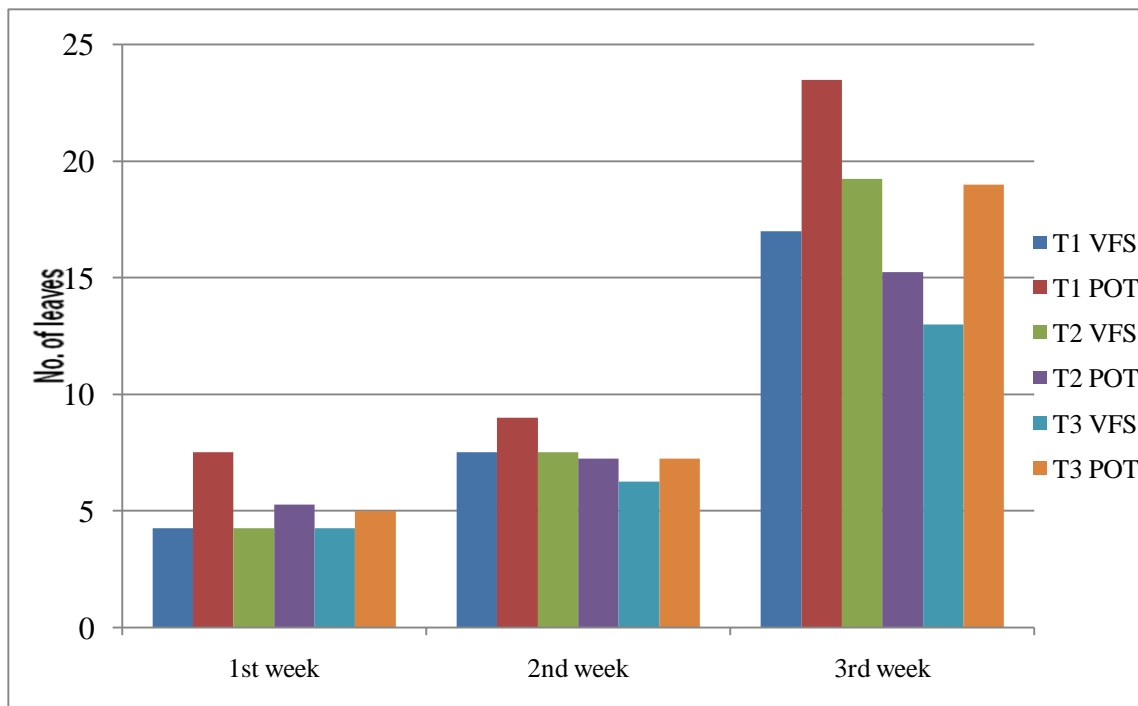


**Fig. 15 Variation of plant girth in different treatments of VFS and potted cultivation**

#### 4.2.2.3 Number of leaves

The observation on number of leaves was first taken one week after planting. After that, the observations were taken in a weekly interval. T1 exhibit better performance in VFS for the first two weeks over the potted cultivation. T2 had highest no. of leaves in the potted cultivation during first two weeks. T3 had better performance under potted cultivation. The highest values were observed for T2 of pot (5), T1 and T2 of VFS (8) and T1 of pot (24) for the first, second and third weeks respectively. Least performance was tagged by T3 of VFS in all the three weeks. The no. of leaves for T1, T2, and T3 for the three weeks of VFS and potted cultivation is shown in the Fig. 16.

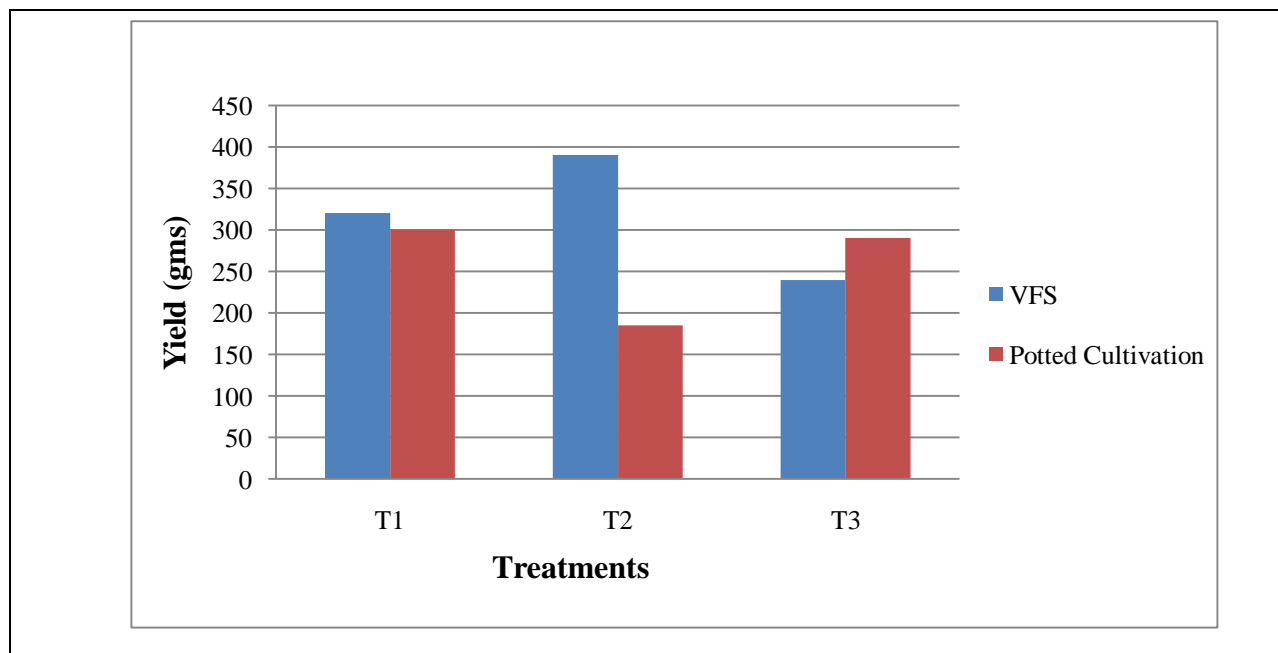
After the third week, number of leaves in T1 of pot is higher than T2 and T3 of VFS and potted cultivation. It is followed by T2 of VFS. The percentage increase in number of leaves is more for T2 of VFS followed by T1 of VFS. Number of leaves of T2 of VFS (19) and T1 of VFS (17) are comparable.



**Fig. 16 Variation of number of leaves in different treatments of VFS and potted cultivation**

#### **4.3 Yield data**

The observation on yield for amaranthus was taken one month after planting. The average yield of amaranthus in grams is shown in Fig. 17. T3 had better performance under potted cultivation. T2 and T1 exhibit highest yield under VFS. The maximum yield of T2 was observed in VFS was about 380 gms. In case of T1 also the maximum yield was observed in VFS, was about 320 gms. The total yield from VFS accounts about 949.85 gms. The total yield under potted cultivation is about 775 gms. The highest yield from VFS is accounted by more number of plants per same area of balconies. Even though the rooting media depth is less in VFS (9 cm) compared to potted cultivation (15 cm), VFS shows better performance compared to potted cultivation in case of T2 and T1. Apart from the shading effect of nearby plants each plant could receive adequate amount of available sunlight.



**Fig. 17 Yield of amaranthus from VFS and potted cultivation under different treatments**

By observing the biometric data obtained for trials with tomato and amaranthus, it is clear that in case of plant height, T1 and T3 had better performance under potted cultivation in each week. But in the case of T2, in VFS shows an increase in height in second and third week. For T2 best performance of plant height were observed in the VFS. Even though the girths were more for the potted cultivation in the first two weeks, the increase in the rate of girth is more for the VFS between successive weeks. During the third week the girth of the plants in T1 and T2 of plants in VFS increased to a higher value than corresponding values for the plants in pots. The percentage increase in girth of the plant is more for T1 of VFS followed by T2 of VFS. In the case of number of leaves, T1 and T2 had highest no. of leaves in the potted cultivation in every week. T1 exhibit better performance in VFS for the first two weeks over the potted cultivation followed by T2 in VFS. After the third week, number of leaves in T1 of pot is higher than T2 and T3 of VFS and potted cultivation. It is followed by T2 of VFS. The percentage increase in number of leaves is more for T2 of VFS followed by T1 of VFS. In the case of yield, T2 and T1 exhibit highest yield under VFS. T3 had better performance under potted cultivation. The highest yield from VFS is accounted by more number of plants per same area of balconies. Even though the rooting media depth is less in VFS (9 cm) compared to potted cultivation (15 cm), VFS shows better



performance compared to potted cultivation. From this, it is clearly evident that, T1 and T2 had better performance in both VFS and potting cultivation. It may be due to the effect of rooting media. T2 in VFS (cocopeat and vermicompost) had the better performance compared to all other treatments followed by T1 of potted cultivation. This is because cocopeat having more water holding capacity and vermicompost can act as a catalyst for the uptake of Nitrogen by the plants. In case of T1(cocopeat and cowdung), there may have more chance of absorption of organic matter content. Even though the rooting depth is less in VFS compared to potted cultivation slight increase in relative humidity and rate of evapo-transpiration in VFS in addition to properties of rooting media played a significant role in increase of yield in VFS compared to potted cultivation.

## **SUMMARY AND CONCLUSION**

## SUMMARY AND CONCLUSION

The study entitled “Fabrication and performance evaluation of vertical farming structure for homesteads” was aimed to fabricate a vertical farming structure suited to flat balcony in KCAET and to compare the performance evaluation of crops under vertical farming structure and potted cultivation.

Two of the balconies of the flat in KCAET, Tavanur with the dimension of 2.2\*0.95\*2m facing west were selected for the installation of VF structure and for potted cultivation. The two selected balconies are at the same floor and receiving almost similar amount of solar radiation. The VFS was fabricated based on the dimensions of the balcony. The flat balcony with the above specified dimension of 2.2m × 0.8m was selected for potted cultivation. As per the dimension of the balcony about 30 pots with top diameter of about 15.5 cm and base diameter of about 7cm could be placed in the floor of the balcony with ten pots on three rows.

Tomato was selected for the first trial of experiment and amaranthus for the second trial. In each trial the seedlings purchased from Instructional farm, KCAET were transplanted into the half splitted PVCs arranged in the three tiers of VFS as well as into the pots. Three rooting media T1, T2 and T3 were prepared by mixing cocopeat and cowdung powder in 3:1 ratio, cocopeat and vermicompost in 3:1 ratio and cocopeat, vermicompost, cowdung powder and soil in 2:1:1:4 ratios respectively. The irrigation and fertilizer application were done manually.

The different rooting media were compared under VFS and potted cultivation by observing the performance of crops grown. For the comparison of performance of crops climatic parameters as well as biometric observations were taken. Climatic parameters such as air temperature, relative humidity and rooting media temperature were observed in the morning, afternoon as well as in the evening at a fixed time for three weeks. Biometric observations such as plant height, plant girth and number of leaves were taken once in week at a fixed day for three weeks. The observations were tabulated separately for VFS and potted cultivation. The results were analysed.

The analysis revealed that there is no significant variation in the maximum and minimum temperature of the two balconies. In both VFS and potted cultivation maximum air temperature was observed at 1.30 pm. The maximum temperature observed in VFS balcony was 31.6 °C and

in potted cultivation was 31.8° C. There is a small increase in air temperature for first 2 weeks in potted cultivation. This is due to the reflection of solar radiation from the floor of the balcony. But in VFS, structure itself may absorb some part of the reflected radiation. But in third week, both the VFS and in potted cultivation shows almost same air temperature. After the full establishment of plants, heat was absorbed by the plants.

The relative humidity is slightly more for the balcony of VFS even though the air temperatures are almost same. This is due to the cooling effect provided by the vertically grown plants in the balcony. The potted plants can contribute less compared to vertically grown plants in the structure for cooling the balcony. The highest values of relative humidity were observed in the morning time due to the cooling effects of plants combined with the least air temperature in the morning.

In VFS, rooting media temperature was less compared to potted cultivation. This may be due to more absorption of heat energy by the plants and the structure, and also at the same time evapo-transpiration is more in VFS due to more number of plants compared to potted cultivation. This is the cause of reduction in rooting temperature in VFS.

By comparing the biometric observations for the trial with tomato, T1 of potted cultivation had the highest plant heights in each week (24.25 cm, 34.55 cm and 54.5 cm). For T2 best performance of plant height were observed in the VFS. The highest value for the plant girth was observed for T1 of pot (6 mm, 10.5 mm and 20 mm for first, second and third week respectively).

Even though the highest girths were observed for the potted cultivation, the rate of rise in girth is more for the VFS between successive weeks. The percentage increase in girth of the plant is more for T1 of VFS followed by T2 of VFS. Girth of T1 of VFS (19 mm) and T2 of VFS (19.5mm) are comparable.

After the third week, number of leaves in T1 of pot is higher than T2 and T3 of VFS and potted cultivation. It is followed by T2 of VFS. The percentage increase in number of leaves is more for T2 of VFS followed by T1 of VFS. Number of leaves of T2 of VFS (19) and T1 of VFS (17) are comparable

The biometric observation for the trial with amaranthus, highest plant height was observed for T1 of potted cultivation in all the three week period (7.875 cm, 15.025 cm, 28.875 cm). But the percentage increase in the plant height is more for T1 of VFS followed by T2 of VFS. Plant heights of T1 of VFS (26cm) and T2 of VFS (29 cm) are comparable.

Even though the highest girths were observed for the potted cultivation, the rate of rise in girth is more for the VFS between successive weeks. The percentage increase in girth of the plant is more for T1 of VFS followed by T2 of VFS. Girth of T1 of VFS (19 mm) and T2 of VFS (19.5mm) are comparable.

After the third week, number of leaves in T1 of pot is higher than T2 and T3 of VFS and potted cultivation. It is followed by T2 of VFS. The percentage increase in number of leaves is more for T2 of VFS followed by T1 of VFS. Number of leaves of T2 of VFS (19) and T1 of VFS (17) are comparable.

In case of yield, T3 had better performance under potted cultivation. T2 and T1 exhibit highest yield under VFS. The maximum yield of T2 was observed in VFS was about 380 gms. In case of T1 also the maximum yield was observed in VFS, was about 320 gms. The total yield from VFS accounts about 949.85 gms. The total yield under potted cultivation is about 775 gms. Even though the rooting media depth is less in VFS (9 cm) compared to potted cultivation (15 cm), VFS shows better performance compared to potted cultivation in case of T2 and T1.

The analysis of trials revealed that VFS can be recommended more precisely for flat balconies in urban areas and as a substitute to the conventional farming practice on limited land area. There is provision for more number of plants per unit area and performance of individual plants can be improved by adequate access for solar radiation and through proper management of fertigation.

By adopting VFS in flat balconies can modify the climatic parameters like temperature, humidity etc. considerably and thereby providing a favorable climatic condition.

Different rooting media were used for the study and observed the effect of different rooting media on the plant growth and yield of plants. The analysis of climatic observation in different trials showed that T2 (cocopeat and vermicompost in 3:1 ratio) had best performance in

VFS compared to T1 and T3. This is because cocopeat is having the more water holding capacity and at the same time vermicompost can act as a catalyst for the uptake of Nitrogen by the plants. The analysis of yield data also showed that T2 had better performance compared to T1 and T3 in VFS. In case of potted cultivation T1 (cocopeat and cowdung power in 3:1 ratio) showed performance than T2 and T3. In potted cultivation, rooting media depth is more. Hence more uptake of organic matter is possible.

### **Scope of the study**

1. The study can be extended by using different plants under different rooting media.
2. The study can be extended by adopting balconies under different conditions.
3. The study can be conducted in conventional land areas as well in green houses under different conditions

## **REFERENCES**

## REFERENCES

- Abernathy, D. 1988. Roof Spray Cooling Systems, *Plant Engineering*, pp 178-180.
- Adeleke Salami, Abdul, B., and Zuzana Brixiova. 2010. Smallholder Agriculture in East Africa: Trends, Constraints and Opportunities , Working Paper No.105
- Agrihouse 2011. Eco-friendly biopesticides: Aeroponic products.  
<http://www.biocontrols.com/secure/shop/listcats.aspx>
- Alexandratos, N., and Bruinsma, J. (2012). World Agriculture towards 2030/2050: The 2012 Revision. ESA Working Paper No. 12-03.
- Antalya Kaleici , Zuhail Kaynakçı Elinc.2013 Use of outdoor living walls in Mediterranean-like climates. *Journal of Food, Agriculture & Environment*, Vol.11 (1):687-692.
- Armar-Klemesu, Margaret. 1999. Urban Agriculture and Food Security, Nutrition and Health, Growing Cities Growing Food International Workshop, Havana.
- Badgley, C., and Perfecto, I. 2007. Can organic agriculture feed the world? *Renewable Agriculture and Food Systems*: 22(2): pp. 80–85.
- Banse, M., v. Meijl, H., Tabeau, A., and Woltjer, G. 2008 . Impact of EU biofuel policies on world agricultural and food markets. *European Association of Agricultural Economists*, pp 647-658
- Behm, Don. 2009. “Growing Power Could Expand Food Programs in Deal with MMSD.”  
[www.jsonline.com/news/milwaukee/59252472.html](http://www.jsonline.com/news/milwaukee/59252472.html).
- Bellows, Anne, C., Katherine Brown, and Jac Smit. 2004. Health Benefits of Urban Agriculture. *Community Food Security Coalition’s North American Initiative on Urban Agriculture*.  
[www.foodsecurity.org/UAHealthArticle.pdf](http://www.foodsecurity.org/UAHealthArticle.pdf).
- Bhadauria, T., and Ramakrishnan, P.S. 1996. Role of earthworms in nitrogen cycle during the cropping phase of shifting agriculture (jhum) in northeast India. *Biology and Fertility of Soils* 22:350–354.



- Blom, T.J. 1999. Coco coir versus granulated rookwool and ‘arching’ versus traditional harvesting of roses in a recirculating system. *Acta hort.* 481: 503-507.
- Brown, K. H., and Carter.A. 2003. “Urban Agriculture and Community Food Security in the United States: Farming from the City Center to the Urban Fringe.” *Community Food Security Coalition*, North American Urban Agriculture Committee. [www.foodsecurity.org/](http://www.foodsecurity.org/) .
- Brown, K.H. and Jameton, A.L. 2000. Public Health Implications of Urban Agriculture. *Journal of Public Health Policy* Vol. 21, pp. 20-39
- Bruce, J., Burton, I., Martin, H., Mills, B., and Mortsch, L. 2000. Water Sector: Vulnerability and Adaptation to Climate Change, Background Paper for Regional Workshops. *Toronto: Environment Canada.* 52 pp.
- Caton Campbell, Marcia, and Danielle, A. 2003. “Community and Conservation Land Trusts as Unlikely Partners? The Case of Troy Gardens, Madison, Wisconsin.” *Land Use Policy* 20 (2): 169–180.
- Chaney, Rufus, L., Susan, B., Sterrett and Howard, W., Mielke. 1984. The Potential for Heavy Metal Exposure from Urban Gardens and Soils. Univ. Dist. Columbia Extension Service, Washington.
- Christian, J.E., and Petrie, T.W. 1996. “Sustainable Roofs with Real Energy Savings”, Proceedings of the Sustainable Low-Slope Roofing Workshop, ed. Desjarlais, A., Oak Ridge National Laboratory, Oak Ridge, Tennessee,99p.
- Cleveland, City of, City Planning Commission. 2008. “Re-Imagining a More Sustainable Cleveland: Citywide Strategies for Reuse of Vacant Land.” Adopted December 19. Available at [http://neighborhoodprogress.org/uploaded\\_pics/reimagining\\_final\\_screen-res\\_file\\_1236290773\\_file\\_1241529460.pdf](http://neighborhoodprogress.org/uploaded_pics/reimagining_final_screen-res_file_1236290773_file_1241529460.pdf).
- Clurfeld, A. 2011 N.J. farmers pioneer new technologies, spaces. The Daily Journal. Retrieved from:<http://www.thedailyjournal.com/article/20110523/NEWS01/105230316>.
- Colasanti, K., Litjens, C., Hamm, M. 2010. Growing Food in the City [http://www.fairfoodnetwork.org/sites/default/files/growing\\_food\\_in\\_the\\_city.pdf](http://www.fairfoodnetwork.org/sites/default/files/growing_food_in_the_city.pdf).

- Dayo Phillip, Ephraim Nkonya, John Pender, Omobowale Ayoola, 2009. Constraints to Increasing Agricultural Productivity in Nigeria: A Review, Nigeria Strategy Support Program (NSSP) Background Paper No. NSSP 006.
- De Kreij, C., Leeuwen, G.J.L. 2001. Growth of pot plants in treated coir dust as compared to peat. *Commun. soil sci. plantanal.* 32: 2255-2265.
- Desta, K. and Ophardt. 2013. Straw Bale Gardening. *Washington State University Extension Publications FS109E*, <http://cru.cahe.wsu.edu/CEPublications/FS109E/FS109E.pdf>.
- Dubbeling, M., and G. Merzthal. 2006. Sustaining Urban Agriculture Requires the Involvement of Multiple Stakeholders. Chap. 2.
- Elhadj, E. 2005 . Experiments in achieving water and food self-sufficiency in the Middle East: the consequences of contrasting endowments, ideologies and investment policies in Saudi Arabia and Syria.
- Evans, M.R., Konduru, S., Stamps, R.H. 1996. Source variation in physical and chemical properties of coconut coirdust. *Hortscience* 31: 965-967.
- Fengxia Dong, Jing Lu, and Allen, M., Effects of Credit Constraints on Productivity and Rural Household Income in China , *Agricultural and Rural Development* , pp 516.
- Gandhi, M., Sangwan, V., Kapoor, K.K., and Dilbaghi, N. 1997. Composting of household wastes with and without earthworms. *Environment and Ecology*, pp 432–434.
- Gaudet, C.1985. Landscaping for Energy Efficiency in Harrowsmith. *Sunspots*, Volume X:1, No. 61. pp. 20-33.
- Gilhooley, M. 2002. Green green grass of work: a little bit of green can go a long way, and we aren't talking about money. *Facilities Design and Management*. <http://www.iuoe.org>
- Gilhooley, M., 2002. Green green grass of work: a little bit of green can go a long way, and we aren't talking about money. *Facilities Design and Management*.
- Givoni, B.1976. Man, Climate, and Nature, 2nd Edition; *Van Nostrand Reinhold*, New York, pp 345

- Goode, Patrick.1986. entry for "Mexico" in *The Oxford Companion to Gardens*; Oxford University Press, pp 371.
- Hoffman, David.1995. *Understanding Frank Lloyd Wright's Architecture*; *Dover Publications*, New York, pp 281
- Holm, D. 1989. Thermal improvement by means of leaf cover on external walls - a simulation model. *Energy and Buildings*, pp 19-30.
- Hynes, H. 1996. *A Patch of Eden: America's Inner-City Gardeners*. *White River Junction, Vt.:* Chelsea Green.
- Jacobs, H. 2008. Introduction to Green Walls Technology, Benefits & Design. *Green Plants for Green Buildings*, <http://greenplantsforgreenbuildings.org/about.htm>
- Jadhav, A.D., Talashikar, S.C., and Pawar, A.G. 1997. Influence of the conjunctive use of FYM, vermicompost and urea on growth and nutrient uptake in rice. *Journal of Maharashtra Agricultural Universities*, pp 249–250.
- Johnston, J., Newton, J. 2004. *Building Green A guide to using plants on roofs, walls and pavements*, *Greater London Authority. London ISBN: 1 85261 637 7*, pp 167
- Karmegam, N., Alagermalai, K., and Daniel, T. 1999. Effect of vermicompost on the growth and yield of greengram (*Phaseolus aureus* Rob) *Tropical Agriculture*, pp 143–146.
- Karmegam, N., and Daniel, T. 2000. Effect of biodigested slurry and vermicompost on the growth and yield of cowpea [*Vigna unguiculata* (L.)]. *Environment and Ecology*, pp 367–370.
- Kaufman, J., and Bailkey, M. 2000. *Farming Inside Cities: Entrepreneurial Urban Agriculture in the United States*. *Lincoln Institute of Land Policy Working Paper*. [www.lincolninst.edu/pubs/dl/95\\_KaufmanBaikey00.pdf](http://www.lincolninst.edu/pubs/dl/95_KaufmanBaikey00.pdf)
- Kuang, Cliff. 2008. *Farming in the Sky*. *Popular Science*. <http://www.popsci.com/cliff-kuang/article/2008-09/farming-sky>
- LabekeVan, M.C., Dambre Van P. 1998. Gerbera cultivation on coir with recirculating of the nutrient solution: a comparison with rockwool culture. *Acta hort.* pp 357-362.

- Maheswarappa, H.P., Nanjappa, H.V., and Hegde, M.R. 1999. Influence of organic manures on yield of arrowroot, soil physico-chemical and biological properties when grown as intercrop in coconut garden. *Annals of Agricultural Research* pp 318–323.
- Manna, M.C., Singh, M., Kundu, S., Tripathi, A.K., and Takkar, P.N. 1997. Growth and reproduction of the vermicomposting earthworm *Perionyx excavatus* as influenced by food materials. *Biology and Fertility of Soils*, pp 129–132.
- Marinari, S., Masciandaro, G., Ceccanti, B., and Grego, S. 2000. Influence of organic and mineral fertilisers on soil biological and physical properties. *Bioresource Technology*, pp 9–17.
- Masabni, J.G. 2009. Vegetable Gardening in Containers. Texas A&M AgriLife Extension *Service Publication* E-545, [http://aggie-horticulture.tamu.edu/vegetable/files/2010/10/E-545\\_vegetable\\_gardening\\_containers.pdf](http://aggie-horticulture.tamu.edu/vegetable/files/2010/10/E-545_vegetable_gardening_containers.pdf).
- McPherson, E. G., Simpson, J. R., and Livingston, M. 1989, Effects of Three Landscape Treatments on Residential Energy and Water Use in Tuscon Arizona, *Energy and Buildings*, pp 127-138.
- Mitchell, A., and Edwards, C.A. 1997. The production of vermicompost using *Eisenia fetida* from cattle manure. *Soil Biology and Biochemistry*, pp 3–4.
- Morland, K., Diez Roux, A.V., Wing, S. (2006). Supermarkets, Other Food Stores, and Obesity: The Atherosclerosis Risk in Communities Study. *American Journal of Preventive Medicine*, pp 333–339.
- Nakamura, Y., and Oke, T.R., 1988: Wind, Temperature and Stability Conditions in an East-West Oriented Urban Canyon. *Atmos. Environment*, pp 2691-2700.
- Nethra ,N.N., Jayaprasad, K.V., and Kale,R.D. 1999. China aster [*Callistephus chinensis* (L)] cultivation using vermicompost as organic amendment. *Crop Research, Hisar*, pp 209–215.
- Palomo Del Barrio, E .1998 . “Analysis of the Green Roofs Cooling Potential in Buildings”, *Energy and Buildings*, Vol 27, pp.179-193.

- Peck, S.W., Callaghan, C., Bass, B. and Kuhn, M.E.1999. “Greenbacks from Green Roofs: Forging a New Industry in Canada”, Research Report, *Canadian Mortgage and Housing Corporation (CMHC)*, pp 180-183
- Peck, S.W., Callaghan, C., Bass, B., and Kuhn, M.E.1996. “Greenbacks from Green Roofs: Forging a New Industry in Canada”, Research Report, *Canadian Mortgage and Housing Corporation (CMHC)*,
- Pothukuchi, Kameshwari, and Jerome L. 2000. “The Food System: A Stranger to Urban Planning.” *Journal of the American Planning Association*, pp 113–24.
- Reddy,R., Reddy MAN, Reddy YTN, Reddy,N.S., Anjanappa, N.,and Reddy, R. 1998. Effect of organic and inorganic sources of NPK on growth and yield of pea, *Legume Research*, pp 57–60.
- Rifkin, G. 2011. Cash Crops Under Glass and Up on the Roof. *The New York Times*, pp 120-123.
- Sailor, D.J.1998. Simulations of annual degree day impacts of urban vegetative augmentation, *Atmospheric Environment*, pp-43-52.
- Schukoske, J. E. 2000. “Community Development Through Gardening: State and Local Policies Transforming Urban Open Space.” *Legislation and Public Policy*, pp 351–92.
- Taha, H., Douglas, S., and Haney, J. 1997. Urban Climates and Heat Islands: Albedo, Evapotranspiration and Anthropogenic Heat, *Energy and Buildings*, pp 99-103.
- Teig, Ellen, Joy Amulya, Lisa Bardwell, Michael Buchenau, Julie, A. Marshall, and Jill, S. Litt. 2009. “Collective Efficacy in Denver, Colorado: Strengthening Neighborhoods and Health through Community Gardens.” *Health & Place*, pp 1115–22.
- Thompson, R.B., and Nogales, R. 1999. Nitrogen and carbon mineralization in soil of vermicomposted and unprocessed dry olive cake (‘Orujo seco’) produced from two stage centrifugation for olive oil extraction.*Journal of Environmental Science and Health, Part B, Pesticides, Food Contaminants and Agricultural Wastes*, pp 917–928.

- Thompson, Wm.1998. "Grass-Roofs Movement", *Landscape Architecture, The Magazine of the American Society of Landscape Architects*, Vol. 88, No. 6, pp.47-51.
- Vadiraj,B.A., Siddagangaiah,D., and Potty, S.N. 1998. Response of coriander (*Coriandrum sativum* L.) cultivars to graded levels of vermicompost. *Journal of Spices and Aromatic Crops*, pp 141–143.
- Vitiello, Domenic, and Michael Nairn. 2009. Community Gardening in Philadelphia: 2008 Harvest Report. *Penn Planning and Urban Studies*, <https://sites.google.com/site/urbanagriculturephiladelphia/home>.
- Walsh, B. 2008. Vertical Farming. *Time Magazine*, <http://www.time.com/time/magazine/article/0,9171,1865974,00.html>
- Wilmers, F. 1988. Green Melioration of Urban Climate. *Energy and Buildings*, pp 289-99.

## **APPENDICES**

## APPENDICES

### APPENDIX I

Variation of Air Temperature of VFS and Potted cultivation at 8:00 am during three week period

Time (Weeks)	VFS		Potted cultivation	
	Maximum temperature(°C)	Minimum temperature(°C)	Maximum temperature(°C)	Minimum temperature(°C)
1 <sup>st</sup> week	28.50	27.55	28.50	27.40
2 <sup>nd</sup> week	27.73	27.30	28.00	27.30
3 <sup>rd</sup> week	28.64	27.80	24.00	23.00

### APPENDIX II

Variation of Air Temperature of VFS and Potted cultivation at 1:30 pm during three week period

Time (Weeks)	VFS		Potted cultivation	
	Maximum temperature(°C)	Minimum temperature(°C)	Maximum temperature(°C)	Minimum temperature(°C)
1 <sup>st</sup> week	31.60	31.20	31.80	31.20
2 <sup>nd</sup> week	30.20	29.50	30.60	29.90
3 <sup>rd</sup> week	26.40	26.00	26.30	25.90



### APPENDIX III

**Variation of Air Temperature of VFS and Potted cultivation at 5:00 pm during three week period**

Time (Weeks)	VFS		Potted cultivation	
	Maximum temperature(°C)	Minimum temperature(°C)	Maximum temperature(°C)	Minimum temperature(°C)
1 <sup>st</sup> week	30.10	29.70	30.30	29.70
2 <sup>nd</sup> week	29.80	28.90	29.90	29.10
3 <sup>rd</sup> week	25.90	25.60	26.50	25.80

### APPENDIX IV

**Variation of Relative Humidity of VFS and Potted cultivation during three week period**

Time (Week)	RH at 8:00 am		RH at 1:30 pm		RH at 5:00 pm	
	VFS	Potted cultivation	VFS	Potted cultivation	VFS	Potted cultivation
1 <sup>st</sup> week	69.10	68.71	62.60	58.50	63.70	63.70
2 <sup>nd</sup> week	68.60	67.40	63.10	61.70	62.90	63.70
3 <sup>rd</sup> week	49.90	49.10	57.85	59.00	58.00	57.30

## APPENDIX V

Variation of Rooting media Temperature of VFS and Potted cultivation at 8:00apm during three week period

Time(Week)	Rooting media temperature ( ° C )					
	T1		T2		T3	
	VFS	Potted cultivation	VFS	Potted cultivation	VFS	Potted cultivation
1 <sup>st</sup> week	27.90	28.60	27.80	28.70	27.60	28.20
2 <sup>nd</sup> week	27.30	28.00	27.40	28.20	27.40	27.70
3 <sup>rd</sup> week	27.20	27.90	27.40	27.90	27.20	27.30

## APPENDIX VI

Variation of rooting media temperature of VFS and Potted cultivation at 1:30pm during three week period

Time(Week)	Rooting media temperature ( ° C )					
	T1		T2		T3	
	VFS	Potted cultivation	VFS	Potted cultivation	VFS	Potted cultivation
1 <sup>st</sup> week	32.50	32.70	32.60	32.70	31.80	32.20
2 <sup>nd</sup> week	31.00	31.40	31.50	31.70	31.00	31.20
3 <sup>rd</sup> week	31.30	31.20	31.40	31.50	31.20	31.30

## APPENDIX VII

**Variation of rooting media temperature of VFS and potted cultivation at 5:00 pm during three week period**

Time(Week)	Rooting media temperature ( ° C )					
	T1		T2		T3	
	VFS	Potted cultivation	VFS	Potted cultivation	VFS	Potted cultivation
1 <sup>st</sup> week	29.30	29.70	30.20	30.50	29.50	29.70
2 <sup>nd</sup> week	28.70	28.90	29.80	30.00	28.80	29.00
3 <sup>rd</sup> week	28.60	28.70	29.50	29.80	28.10	28.50

## APPENDIX VIII

**Variation of plant heights of tomato in treatments T1, T2 and T3 of VFS and potted cultivation**

Time (week)	Plant height (cm )					
	T1		T2		T3	
	VFS	Potted cultivation	VFS	Potted cultivation	VFS	Potted cultivation
1 <sup>st</sup> week	23.43	24.25	18.63	20.70	14.03	16.35
2 <sup>nd</sup> week	28.93	34.55	25.10	23.70	19.50	24.80
3 <sup>rd</sup> week	35.83	54.50	30.50	28.00	24.56	34.50

## APPENDIX IX

Variation of plant girth of tomato in treatments T1, T2 and T3 of VFS and potted cultivation

Time (week)	Plant girth (mm )					
	T1		T2		T3	
	VFS	Potted cultivation	VFS	Potted cultivation	VFS	Potted cultivation
1 <sup>st</sup> week	11.25	13.63	9.75	12.00	5.50	9.50
2 <sup>nd</sup> week	14.75	15.75	14.13	14.34	10.13	11.50
3 <sup>rd</sup> week	18.50	17.13	17.13	16.25	12.89	15.25

## APPENDIX X

Variation of number of leaves of tomato in treatments T1, T2 and T3 of VFS and potted cultivation

Time (week)	Number of leaves					
	T1		T2		T3	
	VFS	Potted cultivation	VFS	Potted cultivation	VFS	Potted cultivation
1 <sup>st</sup> week	23.00	26.00	19.00	22.00	10.00	14.00
2 <sup>nd</sup> week	35.00	33.00	27.00	26.00	20.00	18.00
3 <sup>rd</sup> week	46.00	52.00	34.00	36.00	28.00	29.00

### APPENDIX XI

**Variation of plant height of amaranthus in treatments T1, T2 and T3 of VFS and potted cultivation**

Time (week)	Plant height (cm )					
	T1		T2		T3	
	VFS	Potted cultivation	VFS	Potted cultivation	VFS	Potted cultivation
1 <sup>st</sup> week	4.60	7.89	5.16	6.63	4.50	6.33
2 <sup>nd</sup> week	11.63	15.03	12.25	11.13	8.43	11.55
3 <sup>rd</sup> week	26.63	28.89	28.83	23.00	18.13	25.13

### APPENDIX X11

**Variation of plant girth of amaranthus in treatments T1, T2 and T3 of VFS and potted cultivation**

Time (week)	Plant girth (cm)					
	T1		T2		T3	
	VFS	Potted cultivation	VFS	Potted cultivation	VFS	Potted cultivation
1 <sup>st</sup> week	3.25	6.00	4.75	5.63	4.25	4.50
2 <sup>nd</sup> week	11.00	10.50	12.00	11.25	8.00	9.00
3 <sup>rd</sup> week	19.00	20.00	19.50	16.27	14.75	15.25

### APPENDIX XIII

**Variation of number of leaves of amaranthus treatments T1, T2 and T3 of VFS and potted cultivation**

Time (week)	Number of leaves					
	T1		T2		T3	
	VFS	Potted cultivation	VFS	Potted cultivation	VFS	Potted cultivation
1 <sup>st</sup> week	4.00	4.00	4.00	5.00	4.00	5.00
2 <sup>nd</sup> week	8.00	7.00	8.00	7.00	6.00	7.00
3 <sup>rd</sup> week	17.00	24.00	19.00	16.00	13.00	19.00

### APPENDIX XIV

**Yield of amaranthus from VFS and potted cultivation**

Treatment	Weight (gm)	
	VFS	Potted cultivation
T1	320.00	300.00
T2	390.00	185.00
T3	239.85	290.00
<b>Total</b>	<b>949.85</b>	<b>775.00</b>

**FABRICATION AND PERFORMANCE EVALUATION OF VERTICAL  
FARMING STRUCTURE FOR HOMESTEADS**

**By**

**AMEENA R.K.**

**ANJITHA KRISHNA P.R.**

**SREEKUTTY SURESH V.**

**ABSTRACT**

**Submitted on the partial fulfillment of the requirement for the degree of**

*Bachelor of Technology*

*In*

*Agricultural Engineering*

**Faculty of Agricultural Engineering and Technology**

**Kerala Agricultural University**



**Department of Land & Water Resources and Conservation Engineering**

**KELAPPAJI COLLEGE OF AGRICULTURAL ENGINEERING AND**

**TECHNOLOGY**

**TAVANUR-679 573, MALAPPURAM**

**KERALA, INDIA**

**2015**

## **ABSTRACT**

The study entitled “Fabrication and performance evaluation of vertical farming structure for homesteads” was taken up to fabricate a vertical farming structure as per the dimension of flat balcony in KCAET and to compare the performance of crops under vertical farming structure and potted cultivation. For comparing the performance of plants under vertical farming structure and potted cultivation climatic parameters as well as biometric observations were made. The analysis of climatic parameters suggested that adoption of VFS can modify the climatic parameters (temperature, humidity etc) considerably to provide a favorable climatic condition. The number of leaves, stem girth, plant height and yield varied between the treatments. T2 had the best performance in VFS compared to T1 and T3. The analysis of yield data showed that the highest yield was obtained for the treatment T2 of VFS. In case of potted cultivation, T1 showed best performance than T2 and T3. The study revealed that T2 (cocopeat and vermicompost) is the best rooting media for growing crops in VFS compared to T1 (cocopeat and cowdung) and T3 (cocopeat, cowdung, vermi compost and soil). The study suggested that VFS can be recommended more precisely for flat balconies in urban areas and as a substitute to the conventional farming practice on limited land area and cocopeat and vermicompost is the best rooting media for growing crops in VFS.