

**DEVELOPMENT OF SMALL SCALE PARBOILING CUM
DRYING UNIT FOR PADDY PROCESSING**

By

**ANN ANNIE SHAJU
(2018-18-022)**



**DEPARTMENT OF PROCESSING AND FOOD ENGINEERING
KELAPPAJI COLLEGE OF AGRICULTURAL ENGINEERING AND
TECHNOLOGY**

TAVANUR 679573, MALAPPURAM

KERALA, INDIA

2020

**DEVELOPMENT OF SMALL SCALE PARBOILING CUM
DRYING UNIT FOR PADDY PROCESSING**

by

ANN ANNIE SHAJU

(2018-18-022)

THESIS

Submitted in partial fulfilment of the requirement for the degree of

MASTER OF TECHNOLOGY

IN

AGRICULTURAL ENGINEERING

(Agricultural Processing and Food Engineering)

Faculty of Agricultural Engineering & Technology

Kerala Agricultural University



DEPARTMENT OF PROCESSING AND FOOD ENGINEERING

**KELAPPAJI COLLEGE OF AGRICULTURAL ENGINEERING AND
TECHNOLOGY**

TAVANUR - 679573, MALAPPURAM

KERALA, INDIA

2020

DECLARATION

I hereby declare that this thesis entitled “**Development of small scale parboiling cum drying unit for paddy processing**” is a *bonafide* record of research work done by me during the course of research and the thesis has not previously formed the basis for the award of any degree, diploma, associateship, fellowship or other similar title of any other University or Society.

Tavanur

ANN ANNIE SHAJU

Date:

(2018-18-022)

CERTIFICATE

Certified that this thesis entitled “**Development of small scale parboiling cum drying unit for paddy processing**” is a *bonafide* record of research work done independently by **Ms. Ann Annie Shaju** under my guidance and supervision and that it has not previously formed the basis for the award of any degree, fellowship or associateship to her.

Tavanur

Date:

Dr. Sudheer K. P.

(Major Advisor, Advisory committee)

Professor & Head

Dept. of Agricultural Engineering

College of Agriculture, Vellanikkara

CERTIFICATE

We, the undersigned members of the advisory committee of **Ms. Ann Annie Shaju (2018-18-022)** a candidate for the degree of Master of Technology in Agricultural Engineering majoring in Agricultural Processing and Food Engineering agree that the thesis entitled “**Development of small scale parboiling cum drying unit for paddy processing**” may be submitted by **Ms. Ann Annie Shaju (2018-18-022)** in partial fulfilment of the requirement for the degree.

Dr. Sudheer K. P.
(Major Advisor)
Professor & Head
Dept. of Agricultural Engineering
College of Agriculture,
Vellanikkara

Dr. Prince M. V.
(Member)
Professor & Head
Dept. of Processing & Food
Engineering,
KCAET, Tavanur.

Dr. Rajesh G. K.
(Member)
Assistant Professor
Dept. of Processing & Food
Engineering,
KCAET, Tavanur.

Dr. Rose Mary Francies
(Member)
Professor & Head
Dept. of Seed Science and
Technology
College of Agriculture,
Vellanikkara

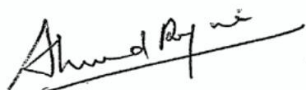

Dr. Regina Ahmed
(Member)
Senior Scientist & Head
Centre of Excellence in Rice Value
Addition, IRRI South Asia Regional
Centre (ISARC), Industrial Estate P O
Varanasi-221106

EXTERNAL EXAMINER



Dr. Sinija V. R.
Professor & Head
Food Processing
Business Incubation
Centre, IIFPT, Pudukkottai Road,
Thanjavur-613005

ACKNOWLEDGEMENT

It is a matter of pleasure to glance back and recall the path one traverse during the days of hard work and pre-perseverance. Every effort in this world comes to its fruitful culmination not because of sincere work of one but only due to the combined support and endeavour of many. I would consider this work nothing more than incomplete without attending to the task of acknowledging the overwhelming help I received during this endeavour of mine.

*I would like to give my first thanks to almighty **God** and my **Parents** as without their mercy, accomplishment of my work and preparation of this manuscript would have not been possible.*

*I express my deep and sincere regards, deepest sense of gratitude and heartfelt thanks to the Chairman of my Advisory Committee, **Dr. Sudheer K. P.**, Professor and Head, Department of Agricultural Engineering, College of Horticulture, Vellanikkara, Thrissur. His meticulous guidance, benevolent criticisms, generous assistance at every stage of my research work is beyond measure, in fact it was his ideas, smooth dealing with the thing which motivated me to work under his guidance and any credit goes to him. It is my proud privilege to express my heartfelt indebtedness and deepest sense of gratitude for laying out the guidelines of research work. I have real admiration and regards to his full hearted support and untiring help.*

*This would be the right moment to thank **Dr. Sathiyam K. K.**, Dean, KCAET, Tavanur for his support during the course of the project work.*

*I take this opportunity to express sincere thanks to my advisory committee members **Dr. Prince M. V.**, Professor and Head, Department of Processing and Food Engineering, K.C.A.E.T, Tavanur, **Dr. Rajesh G. K.**, Assistant Professor, Department of Processing and Food Engineering, K.C.A.E.T, Tavanur, **Dr. Rose Mary Francies**, Professor and Head, Department of Seed Science and Technology, College of Horticulture, Vellanikkara, Thrissur and **Dr. Regina Ahmed**, Senior Scientist and Head, Centre of Excellence in Rice Value Addition, IRRI South Asia*

Regional Centre (ISARC), Varanasi as a members of advisory committee. I am indebted to them for their valuable suggestions during the investigation, sensible criticism in animating and ameliorating the manuscript and valuable counsel during the period of study and I owe them a lot for this small venture of mine.

*I shall never forget the enormous and timely help rendered by **Dr. Sankalpa, K. B., Dr. Vithu Prabha, Er. Saranya S and Er. Sreelakshmi K Unni** for their kind help and support during the course of study.*

*I express my profound sense of gratitude to **Dr. Shahanas E., Er. Thouseena T N, Er. Albin K Joseph, Er. Ashwin Shivanandan, Er. Sooraj M. R. Mr. Sreekesh, Mr. Jithin, Mr. Suhail, Mr. Arun** staff members of Department of Agricultural Engineering, College of Horticulture for their immense help.*

*I use this opportunity to sincerely thank my dearest classmates **Meera T., Geethu M., Megha A.S Anjaly M. G., Fathima K. S. Dilsha Suresh, and P. Babu** for their suggestion and invaluable help during my study.*

*It is ethereal pleasure to express heartfelt reverence to **Department of Seed Science and Technology**, College of Horticulture Vellanikkara for providing paddy to conduct my research work.*

*Selfless love is the dearest commodity on this planet and only a few in this world are kind enough to extend their helping hands. I am expressing my sincere thanks just for love and affection shown to me by my dear ones **Ashly Zacharia and Arun Shaji** for the everlasting source of inspiration and love.*

*I express my thanks to all the faculty **members of library**, K.C.A.E.T, Tavanur for their ever willing help and cooperation. I express my sincere thanks and gratitude to **Kelappaji College of Agricultural Engineering & Technology** for giving me an opportunity to undergo my P.G studies and **Kerala Agricultural University** for proffered me a chance to study in this institution.*

Above all, my success would have remained an illusion without the ambitious encouragement, unquantifiable love, continued calm endurance,

*constant support and affection showered on me throughout the educational endeavour from my beloved parents **Sri. Shaju Thomas** and **Late Smt. Lucy Shaju**. Their blessings and love are the source of my spirit every moment. I have been highly fortunate and lucky to express my heartfelt thanks to dearest my grandma **Smt. Annakutty Thomas** and my relatives for their kind blessings and well wishes showed on me.*

One last word; since it is practically impossible to list all the names who have contributed to my work, it seems proper to issue a blanket of thanks for those who helped me directly or indirectly during the course of study.

..... any omission in this small manuscript does not mean lack of gratitude

Ann Annie Shaju

Dedicated to my Parents

Table of contents

Chapter No.	Title	Page No.
	LIST OF TABLES	i
	LIST OF FIGURES	ii
	LIST OF PLATES	iii
	LIST OF APPENDICES	iv
	SYMBOLS AND ABBREVIATIONS	vi
I	INTRODUCTION	1-4
II	REVIEW OF LITERATURE	5-27
III	MATERIALS AND METHODS	28-51
IV	RESULTS AND DISCUSSION	52-88
V	SUMMARY AND CONCLUSION	89-92
	REFERENCES	93-107
	APPENDICES	
	ABSTRACT	

LIST OF TABLES

Table No.	Title	Page No.
3.1	Specifications of the parboiling cum drying unit	29
3.2	Treatment combinations in hot water soaking	42
3.3	Treatment combinations in cold water soaking	43
4.1	Milling efficiency of parboiled paddy in hot soaking and cold soaking	56
4.2	Head rice yield of parboiled milled rice in hot soaking and cold soaking	59
4.3	Hardness of the parboiled rice in hot soaking and cold soaking	62
4.4	Chroma value of the parboiled milled rice in hot soaking and cold soaking	65
4.5	Bulk density and true density of the parboiled milled rice in hot soaking and cold soaking	69
4.6	Chalkiness values of the parboiled milled rice in hot soaking and cold soaking	70
4.7	Cooking time of parboiled cooked rice in hot soaking and cold soaking	73
4.8	Water uptake ratio of parboiled milled rice in hot soaking and cold soaking	76
4.9	Gruel solid loss of cooked rice in hot soaking and cold soaking	79
4.10	Grain elongation ratio of the cooked rice in hot soaking and cold soaking	81
4.11	Hardness of the cooked rice in cold soaking and hot soaking	84
4.12	Optimized values of independent parameters	85
4.13	Milling and cooking qualities of parboiled paddy after drying in the LSU dryer using the optimized process conditions	87

LIST OF FIGURES

Figure No.	Title	Page No.
3.1	Isometric view of the parboiling cum drying unit	32
3.2	Front view of the parboiling cum drying unit	33
3.3	Right side view of the parboiling cum drying unit	33
3.4	Top view of the parboiling cum drying unit	34
3.5	Sectional view of the LSU dryer	34
3.6	Process flow chart for parboiling of paddy	42
4.1	Effect of parboiling on milling efficiency in hot soaking	55
4.2	Effect of parboiling on milling efficiency in cold soaking	55
4.3	Effect of parboiling on head rice yield in hot soaking	58
4.4	Effect of parboiling on head rice yield in cold soaking	58
4.5	Effect of parboiling on hardness in hot soaking	61
4.6	Effect of parboiling on hardness in cold soaking	61
4.7	Effect of parboiling on the Chroma value of milled rice in hot soaking	64
4.8	Effect of parboiling on the Chroma value of milled rice in cold soaking	64
4.9	Effect of parboiling on the bulk density of milled rice in hot soaking	67
4.10	Effect of parboiling on the bulk density of milled rice in cold soaking	67
4.11	Effect of parboiling on the true density of milled rice in hot soaking	68
4.12	Effect of parboiling on the true density of milled rice in cold soaking	68
4.13	Effect of parboiling on the cooking time of milled rice in hot soaking	72

4.14	Effect of parboiling on the cooking time of milled rice in cold soaking	72
4.15	Effect of parboiling on the water uptake ratio of cooked rice in hot soaking	75
4.16	Effect of parboiling on the water uptake ratio of cooked rice in cold soaking	75
4.17	Effect of parboiling on gruel solid loss in hot soaking	78
4.18	Effect of parboiling on gruel solid loss in cold soaking	78
4.19	Effect of parboiling on grain elongation ratio in hot soaking	80
4.20	Effect of parboiling on grain elongation ratio in cold soaking	80
4.21	Effect of parboiling on hardness of cooked rice in hot soaking	83
4.22	Effect of parboiling on the hardness of cooked rice in cold soaking	83

LIST OF PLATES

Plate No.	Title	Page No.
3.1	Parboiling cum drying unit	37
3.2	Soaking cum steaming chamber	37
3.3	LSU dryer	38
3.4	Conveying channels	38
3.5	Air Blower	39
3.6	Inverted V channels	39
3.7	Heat Furnace	39

LIST OF APPENDICES

Appendix No.	Title	Page No.
A1	Effect of parboiling on milling efficiency and head rice yield in hot soaking	i
A2	Analysis of variance (ANOVA) for milling efficiency in hot soaking	ii
A3	Analysis of variance (ANOVA) for head rice yield in hot soaking	iii
A4	Effect of parboiling on qualities of milled rice in hot soaking	iv
A5	Analysis of variance (ANOVA) for hardness of milled rice in hot soaking	v
A6	Analysis of variance (ANOVA) for chroma of milled rice in hot soaking	vi
A7	Analysis of variance (ANOVA) for bulk density of milled rice in hot soaking	vii
A8	Analysis of variance (ANOVA) for True density of milled rice in hot soaking	viii
A9	Effect of parboiling on qualities of cooked rice in hot soaking	ix
A10	Analysis of variance (ANOVA) for cooking time of cooked rice in hot soaking	x
A11	Analysis of variance (ANOVA) for Water uptake ratio of cooked rice in hot soaking	xi
A12	Analysis of variance (ANOVA) for Gruel solid loss of cooked rice in hot soaking	xii
A13	Analysis of variance (ANOVA) for Grain elongation ratio of cooked rice in hot soaking	xiii
A14	Analysis of variance (ANOVA) for hardness of cooked rice in hot soaking	xiv

B1	Effect of parboiling on milling efficiency and head rice yield in cold soaking	xv
B2	Analysis of variance (ANOVA) for milling efficiency in cold soaking	xvi
B3	Analysis of variance (ANOVA) for head rice yield in cold soaking	xvii
B4	Effect of parboiling on qualities of milled rice in cold soaking	xviii
B5	Analysis of variance (ANOVA) for hardness of milled rice in cold soaking	xix
B6	Analysis of variance (ANOVA) for chroma of milled rice in cold soaking	xx
B7	Analysis of variance (ANOVA) for bulk density of milled rice in cold soaking	xxi
B8	Analysis of variance (ANOVA) for True density of milled rice in cold soaking	xxii
B9	Effect of parboiling on qualities of cooked rice in cold soaking	xxiii
B10	Analysis of variance (ANOVA) for cooking time of cooked rice in cold soaking	xxiv
B11	Analysis of variance (ANOVA) for WAR of cooked rice in cold soaking	xxv
B12	Analysis of variance (ANOVA) for gruel solid loss of cooked rice in cold soaking	xxvi
B13	Analysis of variance (ANOVA) for Grain elongation ratio of cooked rice in cold soaking	xxvii
B14	Analysis of variance (ANOVA) for hardness of cooked rice in cold soaking	xxviii
C1	Response optimization constraints of hot soaking	xxix
C2	Response optimization constraints of cold soaking	xxx
D1	Cost Economics of developed parboiling cum drying unit	xxxii

SYMBOLS AND ABBREVIATIONS

Symbols	Abbreviations
%	: Percent
<	: Less than
±	: Plus or minus sign
°	: Degree
a*	: Greenness or redness
ANOVA	: Analysis of variance
B	: Chroma value
b*	: Blueness or yellowness
°C	: Degree Celsius
°F	: Degree Fahrenheit
CFTRI	: Central Food Technological Research Institute
CRRI	: Central Rice Research Institute
db	: Dry basis
DSG	: Degree of Starch Gelatinization
<i>et al.</i>	: And others
Fig.	: Figure
g	: Gram
GI	: Galvanised Iron
g/cm ³	: Gram per centimeter cube
GI	: Glycemic Index
h	: Hour
hp	: Horse power
HRY	: Head Rice Yield
<i>ie.,</i>	: that is
IRRI	: International Rice Research Institute
KCAET	: Kelappaji College of Agricultural Engineering and Technology

kg	:	Kilogram
kg/cm ²	:	kilogram per centimetre square
kg/h	:	kilogram per hour
kg/m ³	:	kilogram per meter cube
kPa	:	kilo Pascal
L*	:	Lightness or darkness
LSU	:	Lousiana State University
m/s	:	Meter per second
m ³ /s	:	Meter cube per second
min	:	Minute
ml	:	Milliliter
mm	:	Millimeter
N	:	Newton
No.	:	Number
OS	:	Open Steaming
SS	:	Stainless steel
RF	:	Rupture Force
RSM	:	Response Surface Methodology
s	:	Second
SS	:	Stainless Steel
TF	:	Thermic fluid
TI	:	Translucence Index
w/w	:	Weight/ weight
wb	:	Wet basis
ρ_b	:	Bulk density
ρ_t	:	True density
cm	:	Centimeter

INTRODUCTION

CHAPTER I

INTRODUCTION

Rice (*Oryza sativa* L) is consumed by more than half of the world population as their staple food. In 2019, according to the Food and Agricultural Organisation of the United Nations, global paddy production was 769.9 million tonnes (FAOSTAT, 2019) and the national paddy production was 118.4 million tonnes (Indiastat, 2020) during 2019. Rice is rich in carbohydrates, vitamins and minerals. However, polishing of grain affects the nutritional quality by removing the superficial layers of caryopsis from the rice, concentrating the carbohydrate content and reducing the vitamins and minerals. Parboiling of rice resolves these problems to a certain extent since it helps to concentrate nutraceuticals, improves the palatability and extends shelf life. Parboiling is a traditional hydrothermal rice processing treatment intended to gelatinise the starch to enhance the head rice yield, to facilitate the penetration of nutrients present in the bran layer into the endosperm and to reduce their loss during milling. Approximately 20% of the world's rice produced is being parboiled (Buggenhout *et al.*, 2013). Parboiling is mostly practised in countries like India, Pakistan, Bangladesh and Nigeria and also spread into many countries such as Europe, North and South America (Bhattacharya, 2011). In India, about 50-60% of paddy is being parboiled annually (IKISAN, 2019).

Rice is composed of endosperm, germ and bran layers which comprises of dynamic reserves of protein, vitamin, dietary fibre and minerals; also rice kernel contains an excess of starch content (80-90%) (Saikrishna *et al.*, 2013). Parboiling is done before milling to impart more strength to the rice kernel so that it may well withstand the milling stress and improve the head rice yield. Starch granule is composed of the polyhedral crystalline structure and has some inter granular spaces with voids and cracks which results in breakage during milling. Parboiling aids the gelatinization of starch and filling of expanded disrupted protein in the air spaces

of endosperm, thus reducing the breakage. The three main stages of paddy parboiling are soaking, steaming and drying.

Soaking is the hydration process of diffusion of water into the rice kernel, which is essential for the starch gelatinisation. It allows absorbing the moisture leading to swelling of the starch granule, thus enhancing the moisture content to approximately 30% (Bhattacharya, 1996). The temperature of soaking water is usually below the paddy gelatinisation temperature (55°C - 72°C) to assure that the gelatinisation occurs during steaming only. Complete gelatinisation of starch takes place during the steaming process without removal of moisture from the soaked grains and enables the granular texture of starchy endosperm to become pasty, compact and translucent as well as it inhibits the biological process and inactivates the enzymes present in it. Steaming aids in developing stronger kernels which remains intact during the stages of milling. Drying in the parboiling process reduces the moisture content to 12-14% from 37 - 43% which gained through soaking and steaming (Goswami and Murlidhar, 2015). Temperature and the resistance to airflow behaviour of bulk grain are important factors considered in the drying stage. The tempering in the drying process allows the redistribution of moisture within the rice kernel to reduce the moisture gradient brought by the previous drying stage. Tempering affects the rate of moisture removal and grain quality. Drying enables to bring down the moisture content within the safe milling and storage limit.

Starch, the major portion in the rice grain is composed of two constituents such as amylose and amylopectin. Starch present in rice is gelatinised during steaming. The nature of rice starch influences the milling recovery; the crystalline nature decides the cooking qualities, pasting behaviour and glycemic index (GI) of rice. Higher the amount of crystalline nature of rice, higher the breakage, whereas rice having amorphous starch with lower crystallinity brings a lesser amount of milling losses. Parboiling results in conversion of crystalline starch into the amorphous form before the milling stage. The main benefits of parboiling are that the grain contains more vitamin B than the raw rice, the bran of parboiled rice

contains higher oil content (about 25-30% oil) compared to raw rice bran (about 10-20% oil) and the parboiled rice is non-sticky and non-glutinous.

In the present context, where people are more inclined towards food with low GI, the preference to parboiled rice with reduced GI has steeply risen (Larsen *et al.*, 2000). In some areas of South Asia, parboiled rice is preferred because it is typically less sticky than non-parboiled rice (Kato *et al.*, 1983). Besides, it is also preferred by health sensitive consumers due to its better nutritional properties compared to non-parboiled rice. Agronomic conditions during harvesting also promote the need to parboil paddy because almost all the paddy harvested during rainy season and those exposed to flooding during harvesting show excessive breakage during milling (Bhattacharya, 2011). To counteract this, the paddy is parboiled to improve the Head Rice Yield (HRY). Besides enhancing the nutritive value by permitting migration of vitamins from outer to inner layer of rice kernel, parboiling also imparts a hard texture and a smooth surface finish to the grain. This leads to better milling quality and reduced number of brokens resulting in better total rice outturn (72-73%).

The lack of efficient drying method may results in heavy loss during milling of parboiled paddy. The traditional method of drying like sun drying totally depends upon the weather and also causes losses due to scattering, birds and rodents. These disadvantages can be circumvented by adoption of mechanical dryers (Nayak, 1996). In addition, the parboiling is an energy-intensive and time-consuming process. The efforts to save time and energy may affect product quality. Even though improved technologies were developed for parboiling of paddy in the industrial sector, small scale units suffer from losses in conventional grain processing practices and unavailability of low capacity modern equipment. A household paddy parboiling unit which is powered by burning firewood has been developed by Tamil Nadu Agricultural University. But it lacked a drying unit and involved more physical labour (Anon., 2016). The major proportion of people engaged in parboiling process being women, the development of an improved parboiling equipment with reduced drudgery and enhanced safety measures would

greatly improve the employment opportunities to them and in turn, their livelihood. Hence, a study was proposed to develop a small scale parboiling cum drying unit for paddy processing having the capacity of two quintal with the following objectives.

1. To develop a small scale parboiling cum drying unit for paddy processing
2. To evaluate the performance of the developed parboiling cum drying unit

REVIEW OF LITERATURE

CHAPTER II

REVIEW OF LITERATURE

This chapter deals with the reviews on the investigation topic 'Development of small scale parboiling cum drying unit for paddy processing' and sets out to critically analyze the previously published literature concerning the development of parboiling unit for paddy processing, stages of parboiling, milling properties and cooking properties of parboiled paddy.

2.1 PARBOILING

Paddy parboiling is a hydrothermal treatment which done before milling the paddy to accomplish the starch gelatinization and it yields advantages such as higher head rice yield, lesser broken grains, increased resistance to insects, firmer cooked rice texture, less solid loss during cooking, better retention of nutrients and higher oil content in the bran (Pillaiyar, 1988).

The three steps of parboiling enabled the raw rough rice to reach saturation moisture content through soaking, to attain starch gelatinization by adding heat to the moist kernels via steaming and the drying helped to reduce the product moisture content required for milling (Sahay and Singh, 2001).

Paddy is very low in moisture and it is regarded as durable in nature. The moisture content of paddy during the harvest is about 18-22%. Since the amount of moisture inside the paddy was changes according to the environmental condition, the harvested paddy should be dried up to 12-13%. Parboiling is a pre-milling treatment which gives significant physico-chemical reforms in rice. The soaking temperature and steaming pressure influences the moisture absorption by the grain, thus affecting the time requirement. This hydrothermal treatment which is done before the milling stage brings about physical, chemical, and physio-chemical modifications in rice. Moisture absorption by the grain that depends on soaking temperature and steaming pressure determines the time required for the parboiling (Mohanty *et al.*, 2002).

Ilyas and Goel (2003) stated that parboiling helped in the gelatinisation of starch thus strengthen the kernel and enabling the grains to withstand breakage during milling. The sun cracked grains bind themselves remarkably well and mill like hard whole grains after they were parboiled

The traditional method of parboiling took one to two days for soaking of paddy in the water in room temperature and the modern way of parboiling completed the process in a shorter time which depended on the temperature of soaking water. Long duration cold water soaking leads to microbial growth and off-flavour development, whereas hot water soaking required high energy inputs and produced unsatisfactory colouration to the kernels (Saifullah *et al.*, 2004).

Parboiling allows the migration of several compounds from the aleurone layer into the grains, thereby increasing the nutritional value. The three main stages of parboiling were soaking, steaming and drying. Soaking done in hot water to increase the moisture content. Steaming was done to establish partial or complete gelatinisation. Drying helps to preserve the moisture content for storage and milling (Ondier *et al.*, 2012).

2.2 DEVELOPMENT OF PADDY PARBOILING SYSTEM

Levan *et al.* (1990) conducted a study on parboiling of paddy using a husk fired inclined grate furnace and a CRRI mini parboiling unit in KCAET Tavanur. Husk fired grate furnace provided the heat required for steaming and drying. The parboiling unit consisted of two chambers, separated by a perforated portion to enable both soaking and steaming in the same unit. A central GI pipe with perforated laterals was provided for uniform distribution of steam. Rice husk at the rate of 10 kg/h produced the heat required for soaking and steaming 75 kg of paddy. The parboiling process was done with soaking and steaming time of 2 h and 15 min respectively with a head rice yield of 64.5% and total yield of 67%.

Pillaiyar (1995) developed a thermic fluid parboiling system (TF) and compared with the open steaming (OS) process to save the processing time, to improve the quality of the product and to fulfil the needs of both the industry and

the consumer. It consists of insulated SS cylindrical drum, a circular top plate, temperature sensing devices and a hand stirrer. The preheated thermic fluid was circulated inside the cylindrical drum and its temperature was controlled by centrally placed stirrer. The TF system reduced the moisture content of the soaked paddy as well as it had superior milled rice whiteness compared to the open steaming process.

A conduction parboiling technique was developed by Varadharaju and Sreenarayanan (2004) using industrial oil as fuel. Compared to conventional methods, the energy required for the conduction parboiling was only 50%. The overall efficiency was found to be 43.32% and the heat utilisation efficiency was increased to 77.5%, 58% and 25% for soaking, parboiling and drying respectively.

A parboiling equipment was developed by Houssou and Amonsou (2004) to increase the quality and yield of the parboiled paddy. The two main components of the equipment were vat and a pot. In comparison to the traditional methods, the improved method yielded uniformly steamed product. This method significantly reduced the rate of cracks from 24% (traditional method) to 15% (improved method), improved the rice husking out turn from 64% (traditional method) to 70% (improved method) and consumed less duration for the sun drying.

A Pressure parboiling system for paddy was designed and fabricated in KCAET Tavanur. It consisted of a pressure parboiling tank with steam distribution pipes, a steam generator and instrumentation for measuring pressure and temperature. Paddy was treated under different soaking temperature for different soaking periods at different parboiling pressures for parboiling time. The milling quality, cooking quality and physical characteristics of the pressure parboiled paddy under selected treatments were also found and the results were compared with the traditional parboiling process. The study indicated that pressure parboiling with a soaking period of 30 min at 70°C and a pressure of 1 kg/cm² is optimum for *Jyothi* variety of Paddy (Simi and Sudeep, 2006).

Umogbai (2013) developed a farm level paddy parboiling device having 200 litres capacity and compared it with the traditional and improved parboiling method. The peculiarity of this device was that there was a rotating grid which was acting as a stirring unit and the steaming chamber lay below the soaking chamber. The performance of this device was assessed using long grain rice. The results showed that the improved parboiler had a significant advantage. It required only less time of operation and was cheaper than the traditional method. There was no significant difference in the water uptake ratio between the two methods. The quality of rice developed by the improved parboiler was also good compared to the traditional parboiler.

A parboiling device was designed in Nigeria for the rural farmers to parboil a maximum of 70 kg of paddy per batch. It consisted of the steaming chamber which was directly below the soaking chamber. A rotating grid was incorporated to serve as a stirrer. The parboiler was mounted on a tilting frame for ease of evacuation of the paddy after parboiling. Firewood was used as the source of fuel. The performance of the developed parboiler was compared with the traditional and industrial method of parboiling. The results showed that the developed parboiler took lesser time of operation with a soaking time of three hours at 70°C and steaming time of 20 min at 95°C. The industrial method was an imported technology and it was not available for use by the bulk of the rural farmers which produce 80% of the rice consumed in Nigeria (Gbabo *et al.*, 2014).

A study was conducted by Bello *et al.* (2015), to assess the parboiling practices and constrains hindering the local parboiling technology in Kano State. From the evaluation based on a structured questionnaire and field study, information about the method of parboiling, equipment used, cost of parboiling, variety of paddy used, parboiling capacity and challenges of the parboiling activities were obtained. The survey revealed that parboiling was mostly done manually between a soaking temperature ranges of 55⁰C to 70⁰C with a time range of 9 to 17 hours. Lack of modern parboiling technologies and poor understanding of the process of parboiling were the major constraints faced by the processors.

TNAU had developed a household parboiling unit having a capacity of 125 kg/batch to parboil the paddy uniformly. It consists of a drum and is divided into three equal portions. The top two-third portion retained paddy for parboiling and bottom one-third portion held water to produce steam for parboiling. The water in the drum was heated by burning firewood or any agricultural waste. After the completion of parboiling of first batch, the remaining hot water could be used for the next batch. But it had only a steaming chamber. Soaking and drying was done separately (Anon., 2016)

Srisang and Chungcharoen (2019) conducted a study by applying a rotating sieve system to the parboiling process for parboiled rice production. This method increased the quality of parboiled rice such as degree of gelatinization (DOG) (65.02%–100%) and head rice yield (HRY) (69.65%–72.50%).

Traditional parboiling consists of double parboiling and single parboiling whereas modern method includes several processes such as CFTRI method, Jadhavpur university method, Converted process (U. K.), Avorio process (Italy), Malek process, Fernandes process, Cristallo process, Schule process (Germany), RPEC method, Pressure parboiling process (India) and Rice Growers Association of California process (Chakraverthy, 1981; Sahay and Singh, 2001). In Indian mills, CFTRI methods are found to be commonly used. The quality characteristics of parboiling depend on the method of parboiling used. Each step of parboiling plays a major role in the quality of rice. So the investigation of each step in parboiling helps to evaluate its effect on the rice quality characteristics.

2.3 METHODS OF SOAKING

Indian Institute of Technology, Kharagpur developed a parboiling method consist of soaking at a temperature of 70 to 80°C for 3.5 h (Ali and Ojha, 1976). Parboiling by hot soaking for 1.5 h at 80-85°C was sufficient to gelatinize the grain. The process eliminated the steaming step. The grain was equilibrated for 1-1.5 h in the container which was insulated to retain the heat after draining the water and the moisture penetrated into the grain aids in gelatinization. The soaking time varied

depending upon the temperature and the variety of paddy. Uniform gelatinisation of paddy could be achieved, when the moisture and the heat reached the centre of the grain through fast hydration (Bandopadhyay and Roy, 1976).

Soaking sometimes called as steeping process was regarded as the most overwhelming process in parboiling. The paddy (rough rice) is allowed to fully submerge in the water to gain the sufficient moisture content which enables it to gelatinise on succeeding heating by supplying steam to it. Generally soaking is carried out at a temperature lower than its gelatinisation temperature of the rice to be soaked (Luh and Mikus, 1980).

The odour developed due to the soaking in conventional parboiling could be abolished by the immersion of paddy in the water having 0.10% mercuric chloride, 0.1% copper sulphate, 0.05% sodium chromate, 0.3% ferric chloride, 0.15% Acinol and 0.1 % thiram. Out of these, 0.05% sodium chromate (w/w) eradicated the smell as well as it diminished the soaking loss to a great extent (Pillaiyar *et al.*, 1980).

In the CFTRI method of parboiling, soaking was done for 3.5 – 4 h at 70°C. This method gave higher head rice yield. However, the product had a yellow colour. The yellow colour was due to a non-enzymatic browning reaction and could be reduced by giving suitable soaking temperature and time (Vassan, 1982).

Soaking in the single steam method of parboiling took two to three days and resulted in a fermented bad smell which reduced the acceptability to the consumer. Double steam method upgraded the single steam method by reducing the soaking hours to 36 h by steaming of paddy before and after soaking in water. The double steam method gave higher head rice yield and had a good market value (Bhattacharya, 1985). These methods induced low colour to the milled rice and cook to a softer texture.

Full soaking process aids the paddy to reach a moisture content of about 30-35%. Since soaking is a temperature dependant process, high soaking temperature yields high soaking rate and vice versa. Low-temperature soaking led

to microbial contamination due to the longer soaking duration which affects the colour, taste and aroma of the grains. Though higher temperature soaking is time-saving, it might result in more leaching loss while cooking of parboiled rice (Velupillai and Verma, 1986).

Soaking is a hydration step that increases the moisture content of paddy to about 30% which was essential for the completion of the parboiling process. At room temperature, it was allowed for 24 h with paddy and water ratio by mass 1:1.2 (Haque *et al.*, 1997). To achieve 30-35% (wb) moisture, Ramachandra *et al.* (2000) proposed that 6h of soaking the paddy at 65°C was enough for a better head rice yield.

The study done by Miah *et al.* (2002) on the effect of hot soaking on the physicochemical parameters of rice found that the quality of milled rice increased with increase in the duration of hot soaking. The highest degree of gelatinisation was obtained when the paddy was soaked at 80°C for 120 min. The gelatinisation on parboiling made the grain stronger and improved the milling qualities.

The quality of parboiled paddy could be improved by reducing the duration of soaking. Igathinathane *et al.* (2005) developed a combination soaking procedure based on the fact that hydration of paddy below the gelatinisation temperature preserves desirable quality and it took more time. Soaking of paddy at temperatures above the gelatinisation temperature leads to the contamination of soak water and husk splitting. The developed combination procedure involved the use of 80°C water up to a moisture content of 35% d.b followed by using 70°C water till a saturation moisture content of 42.7% db. Compared to single-stage soaking at 70°C, this method resulted in a 67% reduction of time. The polished rice of single-stage soaking and double stage soaking did not show any difference in terms of head rice yield, broken grains produced, and the cracked grains produced.

Kashaninejad *et al.* (2007) observed the soaking behaviour with respect to the soaking temperature at 25, 30, 40, 50, 60, and 70°C and they found that initially there was rapid water uptake followed by the slower rate in the later stages and

reached to the saturation moisture content finally. The husk of the paddy always act as a barrier for the water absorption.

Different rice varieties might have different soaking conditions. In a study, Ejebe *et al.* (2015) reported that FARO60 variety of paddy needs to be soaked at 60°C for 6 h, Bisalayi, FARO44 and FARO52 varieties for 7 h whereas FARO61 required soaking for 8 h to achieve the desired level of moisture content (40% db). From the above recommendations, it was noticed that a single recommendation cannot be applied to all variety. Soaking conditions varied with individual variety.

Soaking aims to eliminate the ungelatinised portion of rice called white core. Two methods of soaking are ambient temperature soaking and high-temperature soaking. Former one usually took 1-3 days to hydrate the rice grains and the later one accelerates the water penetration rate, shortens the soaking time and inhibits the fermentation and enzymatic reaction (Leethanapanich *et al.*, 2016).

The application of hot water and cold water soaking in paddy parboiling process was studied by Gunathilake (2018). For hot soaking, the temperature of the water was set to 70°C after filling the paddy and kept for 6 h. The traditional way of parboiling was done for 50 h in cold water. High amount of moisture was absorbed in hot water soaking when compared to cold soaking in a short period of time. The rice kernal in hot soaking absorbed water rapidly and saturated to the moisture content 43.8% (db.) after 6 h. Traditional parboiling attained the saturation moisture content of 44% (db.) in 48 h.

2.4 METHODS OF STEAMING

Researchers investigated different steaming conditions for parboiling the rice. The husk of the soaked paddy started to split when it was steamed at a pressure of 4 kg/cm² in CFTRI method of parboiling (Araullo *et al.*, 1976). Husk splitting was regarded as the signal of completion of parboiling.

Saxena *et al.* (1989) reported that the milling quality of parboiled paddy was improved on the continuous steaming process under pressure over the raw paddy.

Steaming of paddy at a pressure of 2 kg/ cm² for 10 minutes yield a head rice yield of 68.6%.

Generally steaming was given after the soaking treatment. Gelatinisation of starch is the main aim of steaming. Marshall *et al.* (1993) reported that rice kernel reaches complete gelatinisation within a very short duration of steaming if it had a moisture content of more than 32%. The ability of the parboiled rice kernels to repel the milling forces could be improved by increasing the steam heat treatment.

Bhattacharya and Rao (1996) studied the milling yield and process parameters of parboiling. They suggested that under adverse condition of drying, good milling results could be obtained if there was severe prior heat treatment at the steaming stage. Steaming process enables the complete gelatinisation of starch without removing the moisture from the soaked paddy. Inactivation of most of the enzymes and biological process occurs during the steaming process. Due to the gelatinisation process on steaming, the granular texture of the starchy endosperm becomes pasty resulting in the sealing of cracks and the endosperm becomes more compact and translucent.

Roy *et al.* (2004) conducted a comparative study of open and closed steaming to improve the traditional parboiling process. The study was based on the double steaming process of direct heating under open and covered conditions with a rice cooker. Soaking and steaming were carried out in a cooker. About 20% of paddy was submerged in water for the steaming process. Analysis of the average value of hardness indicated that the covered method had a higher degree of parboiling and consumed less amount of energy. But the parboiled brown rice in the bottom layer exhibited more hardness and there was no difference in the overall quality indices between two methods.

Sareepuang *et al.* (2008) suggested a steaming time of 15 min at 121°C for small batches to obtaining best quality of parboiled paddy. For large batches, 20-30 min of steaming was necessary. A study was conducted by Swasdisevi *et al.* (2010), to investigate the effects of pre steaming time on qualities

of partial-parboiled rice. The results revealed that head rice yield increased with increase in pre steaming time whereas there was a decrease in the presence of white belly decreased. Steam could be supplied either through saturated as in open system or superheated in a closed system. The major factors affecting the steaming was its pressure and duration. The severity of steaming affected the degree of gelatinisation and had a direct effect on the quality of rice (Dutta and Mahanta, 2012).

Taghinezhad *et al.* (2016) conducted a study on the relationship between the degree of starch gelatinization and quality attributes of parboiled rice during steaming. Paddy rice samples were parboiled for a soaking duration of 3 h at 65°C, and steaming at 96°C for 2 to 10 min. The degree of starch gelatinization (DSG) and several quality attributes (head rice yield (HRY), colour value and hardness) of parboiled rice were measured. Results showed that DSG (46.8%–77.9%), colour value (18.08–19.04) and hardness (118.6–219.2 N) increased following steaming. In contrast, the HRY increased (64.8%–67.1%) with respect to steaming times between 2-4 min and decreased (67.1%–65.0%) for steaming times between 4-10 min.

Hasbullah (2017) evaluated the effect of duration of steaming on physicochemical quality and glycaemic index of parboiled rice. The paddy soaked for 4 hours in 60°C hot water was steamed for 20 and 30 min at 100°C. Analysis of milled paddy which was dried to a moisture content of 14% showed that steaming process of 20 minutes duration produced high values of head rice yield, ash, fat and protein content and the low values of glycaemic index and carbohydrate content.

2.5 METHODS OF DRYING

Drying method influences the mechanical properties of the grain such as grain hardness which directly depends on the efficiency of rice milling. During harvest season, the moisture content of paddy was about 22-26% (wb) and it should be dried to 13-14% (wb) to reduce the respiration rate, to inhibit mould growth and to prevent the production of mycotoxins (Hall, 1970).

Drying of parboiled paddy was done to increase the head rice yield and to reduce the moisture content to the optimum percentage required for the milling and storage. The difference between the drying of parboiled rice and raw rice was that the initial moisture content of raw rice was smaller than that of parboiled rice and also the texture of rice kernel between these two types were different due to the compact nature and gelatinisation of rice starch (Gariboldi, 1974).

Drying in traditional parboiling was carried out in sunlight for 1-2 days. First, it was dried to 18-20% (wb) of moisture content and kept heaped overnight for suffusing. Then it was dried to about 14% (wb) to get better quality and higher milling yield (Rahaman, *et al.*, 1996).

Wiset (2001) conducted a study on the effect of two-stage drying on rice quality. The first stage used high temperature (up to 150°F) to decrease the moisture to 18% (wet basis) and it was followed by the second stage at ambient temperature to reduce the moisture content to 14% (wb). Adopting two-stage drying, we could increase the efficiency of drying.

Parboiled paddy should be dried to 14% moisture for safe storage or milling. The continuous-flow dryer (LSU type) was a recirculating batch dryer. Wet paddy was recirculated in the dryer until it reaches 14% moisture. In contrast with raw paddy, parboiled paddy required air temperatures of up to 100°C and below 75°C during the first and second drying period respectively. The first drying period took about three hours including dryer loading and unloading time. After tempering, the second drying period took about two hours (IRRI Rice knowledge bank. n.d).

Islam *et al.* (2003) found that, drying of parboiled rice was difficult compared to raw rice. This consumes more energy for drying to the desired moisture content. Drying time could be reduced by using higher air temperatures, but it led to the development of internal stresses in the grain and cause breakage during milling. Fissuring could be reduced by providing drying temperatures between 35°C and 45°C.

Drying temperature below 95°C was recommended for the paddy subjected to parboiling to maintain the rice taste and quality (Lan and Zheng, 2004). Higher drying air temperatures accelerate the drying process by creating higher moisture gradients, it also caused problems like discolouration, fissures, and resultant broken grains.

Rao *et al.* (2007) optimised the drying variables in thin layer drying of paddy. Head rice yield of 65-68% obtained for a combination of variables like bed depth 7-10 cm, air velocity 0.55-0.68 m/s and drying air temperature of 112-116°C.

A study was conducted by Swasdisevi *et al.* (2010), to investigate the effects of drying temperatures on qualities of partial-parboiled rice using hot-air fluidization technique. To obtain the suitable conditions for producing partially-parboiled rice using hot-air fluidization technique, paddy was soaked at the temperature of 80°C for 5 hours and then it was blown with saturated steam having a temperature of 102°C for 70 s (pre-steaming). Subsequently, it was dried using fluidization technique at the hot-air temperature of 140°C for 2 min and then it was tempered for 30 min; furthermore, it was ventilated at ambient air temperature until the final moisture content reached approximately 14–16% db.

The effects of temperature (66-84°C), heating time (30-180 min), and tempering time (60-420 min) on milling yield and gelatinisation degree was studied by Bello *et al.*, (2015). They found that the highest milling yield (67.7%) and maximum value of the degree of gelatinisation (37.0%) were yielded at a process temperature of 84°C using heating and tempering times of 104 min and 178 min respectively.

The effects of temperature of drying the paddy was studied by Zheng and Lan (2007). Paddy was dried with heated air temperatures of 45°C, 50°C, 55°C, 60°C and 65°C. Drying of paddy at temperature of 55°C did not affect cooking and eating qualities of rice. Drying temperature of 55°C was recommended to dry the paddy for obtaining the higher head rice yield and hardness value.

2.6 MILLING PROPERTIES OF PARBOILED PADDY

The preferences of the consumer for milled rice vary from country to country. Majority of the consumers favour well-milled white rice with little to almost no bran on the endosperm. Indian consumers prefer well-milled rice and well-milled sticky rice was preferred by Japan consumers (Lyon, 1999). Even though parboiling results in the improvement of head rice yield by reducing the number of broken, it also increases the hardness and darkness of the rice kernel. Several studies were done to evaluate the changes in colour and hardness of parboiled rice bought by the parboiling process.

2.6.1 Milling efficiency and head rice yield

The drying of paddy in a thin bed of 5 cm at drying air temperatures of 40, 50, 60, 70 and 80°C showed that the fissured grains increased linearly with increase in temperature of drying air which decreased the milling yield. The maximum head rice yield obtained for a hot air temperature of 50°C or less, tempering period of 36h and a moisture content of 14% (Samsher and Narain 1989).

The effect of grain fissuring on milling quality was noted by Shrivastava and Narain (1990). They found that the fissuring of rice kernels influenced the milling quality of paddy. The number of fissured kernels on milling was inversely proportional to the head rice yield. The short variety showed small resistance to fissuring comparing to the long-grain variety

The maximum head rice yield was obtained when the starch had reached about 40% gelatinisation. Extensive parboiling led to extensive starch gelatinisation which was not necessary to obtain the maximum head rice yield (Marshall *et al.*, 1993). Das *et al.* (2004) found that the major reduction of head rice yield of infrared parboiled rice was due to the increase in the moisture removal rate due to the increased radiation intensity.

The milling is referred as the conversion of paddy into the edible form of rice by the removal of outer seed-coat (husk) and bran layers. Paddy grains consist of outer protective husk layers which is harmful for human consumption. So the

removal of this outer portion was the essential criteria in rice milling. The effect of parboiling on hulling, milling and head rice recovery of a check variety and six hybrids of paddy showed that the parboiling had increased the head rice recovery of hybrids to 12.9% and there was no difference in the post-harvest characteristics such as hulling and milling recovery between hybrids and check variety (Naik *et al.*, 2006).

Sareepuang *et al.* (2008) studied the effect of soaking temperature on the head rice yield of KDML 105 rice and reported that head rice yield of parboiled paddy were 59.22, 82.98 and 84.40% for the soaking temperatures 40, 50 and 60°C respectively, while it was only 50.92% for the raw paddy it was only 50.92%. Increase in soaking temperature and severity of steaming affected the head rice yield.

Patindol *et al.* (2008) conducted a study on the steaming of pre-soaked paddy under severe (20 min, 120°C, 98 kPa) and mild (20 min, 100°C, 0 kPa) steaming treatments and found that that head rice yield was higher for the batch that subjected to severe steaming conditions. When the rice was parboiled with a steam pressure of $5.5 \times 10^4 \text{ N/m}^2$, about 93.3% of HRY was obtained.

2.6.2 Hardness of parboiled rice

Roy *et al.* (2003) found that higher degree of parboiling increased the hardness of the rice in the inside layer than the surface layers. Soaking and steaming changes the structure of the bran layer and fills the fissures and cracks. Thus the structure of the endosperm became more compact and it increased the tensile strength.

Bello *et al.* (2006) examined the quality features of the milled and cooked rice after the hydrothermal treatment. Tempering increased the quality indexes and the temperature affects the rupture force (RF) and translucence index (TI). The rice showed intermediate values of textural properties between raw and traditional parboiled rice after tempering with a soaking period of 24 h at 25°C and heating at 85°C (174.4 min) or 93.7°C (45 min).

Hardening of rice had a key role in the parboiling process. The hardness of the grain had an impact on grain characteristics such as resistance to the insect damage, cooking quality etc. Comparatively parboiled rice was harder than the raw rice at the same moisture content due to change of starch from crystalline form to the amorphous form as a result of the irreversible swelling and fusion of starch granules (Fofana, 2011).

2.6.3 Colour of the parboiled milled rice

Generally, parboiled rice has an amber colour. The change in colour depended on several factors like temperature of soaking water, soaking time, steaming pressure and duration, drying temperature and drying time (Bhattacharya and Subba Rao, 1996; Ali and Pandya, 1974). Consumer prefer the production of lighter parboiled rice. The long duration of soaking and high temperature steaming upsurges the colour intensity and lightness of parboiled rice (Pillaiyar and Mohandoss, 1981). Non-enzymic Maillard type reaction was the major reason for the change in colour of the paddy. Maillard reactions happen when the sugars (from the carbohydrates) and the amino acids (from the proteins) within the grain reacts.

The soaking temperature had an impact on the rice colour, as the soaking temperature increases, the colour of the soaked rice became darker and vice versa. Changes of rice colour in soaking were due to the diffusion of some compounds into the endosperm from bran layers (Lamberts, 2006).

Champa *et al.* (2006) studied the hydrothermal treatment of paddy with a soaking period of two hours at room temperature and 25 min of steaming in atmospheric pressure. It retained a high degree of whiteness compared to non-parboiled rice. Brown rice (Variety: KDML 105) had lightness value of 58.63 before soaking and it was reduced to 53.80, 52.65 and 51.30 after soaking at 40,50, and 60⁰C respectively.

Sareepaung *et al.* (2008) reported that the increase in soaking temperature of paddy during parboiling decreased the lightness value and increased the colour value. They inferred that less coloured product could be gained by lowering the

soaking temperature. The colour and lightness value of parboiled rice depends on the treatment conditions. The darkening of parboiled rice has also happened with the effect of migration of pigments from the husk and bran into the endosperm. The price of parboiled rice depends on the grain whiteness / lightness. The whiteness value was an effect of duration of soaking and steaming (Dutta and Mahanta, 2012).

Pal *et al.* (2018) reported that parboiled samples were more yellow (higher b values) and darker colour (lower L values) than non-parboiled rice when the initial soaking temperature and steaming time was increased. The b value increased steadily with increasing steaming time.

Xiaonan (2019) found that raw rice had an opaque appearance and the parboiled rice showed a translucent amber colour on a study on the effect of ultra-high pressure on quality characteristics of parboiled rice. Parboiled samples had less L* values and higher a* and b* values.

2.6.4 Bulk density and true density

The behaviour of bulk density was tandem such that, it first decreased as the degree of milling proceeded and later it increased due to the initial increase and subsequent decrease in the amount of fat on the surface of the milled grain (Bhattacharya, 1969). The bulk density and true density depended on the degree of milling and the roundness of the grain.

The behaviour of the true density of the grain was different that it was increased from 1208.71 kg/m³ to 1342.70 kg/m³ when the temperature of soaking increases from 25 to 40°C and at 70°C, it was decreased to 1258.71 kg/m³. The changes of true density was due to the increase in the mass of the grain with a corresponding increase in the volumetric expansion (Kashaninejad *et al.*, 2009).

Bulk density of non-parboiled rice was found to be 0.80 g/cm³ in a study of hydration behaviour of non-parboiled milled rice used in Nigerian traditional cuisine done by Danbaba *et al.* (2014). The study done by Anggi *et al.* (2016) noted that parboiling had no significant effect on the bulk density of partially milled parboiled rice. The keen observation on the physical properties of parboiled milled

rice over the entire range of degree of milling from 0 to 8% showed that as milling progressed, the true density increased slightly due to the loss of lighter fat on the milling process.

2.6.5 Chalkiness

Parboiling eradicates chalkiness and increases the grain translucency. Gariboldi (1974) stated that the presence of white-bellied rice was due to the incomplete parboiling resulting in lower milling yield. Parboiling helps in the disruption of proteins and gelatinisation of starch. The gelatinised starch later expand and occupy all the voids present in the endosperm and yields the translucency of the paddy grain (Kondo, 2006). Grain translucency was the good quality indicator of parboiled rice and it determines the grain appearance. For both parboiled and non-parboiled rice, the low chalky score indicates better sensory quality. Grain translucency was inversely proportional to the amount of chalkiness (Manful, *et al.*, 2008).

Quality indicators of the parboiled rice were translucency and chalkiness and these both factors were inversely related. Raw milled rice having chalkiness score five was reduced to 'one' when the paddy was parboiled and thus parboiling increased the translucency of the endosperm (Fofana, 2011).

The coexistence of a porous structure in the chalky rice made it susceptible to rupture and the presence of either a soft or hard texture during cooking resulting in poor palatability of the cooked rice. So the rice grains having less than 5% degree of endosperm chalkiness was referred to as low chalky grains (Zohoun *et al.* 2017). Parboiling treatments reduced the percentage of chalkiness from 5.2% to less than 1% compared to the non-parboiled sample on increasing the initial soaking temperature from 30 to 90⁰C (Pal *et al.*, 2018).

2.7 COOKING CHARACTERISTICS OF PARBOILED PADDY

Cooking quality is an important quality factor of parboiling. Higher market price could be gained for the rice having good cooking quality. Parboiling significantly impacts cooking characteristics such as cooking time, water uptake

ratio, gruel solid loss, grain elongation ratio and hardness during cooking. The cooking process of parboiled rice consumes more time due to the change of starch granules from crystalline to amorphous form which made the endosperm texture more compact and translucent (Oli *et al.*, 2014).

2.7.1 Cooking time

The cooking of parboiled rice took longer time to get the same degree of softness compared to the raw rice of the same variety. Soaking treatments might have resulted in the partial gelatinisation of starch which may affect the cooking time. Sareepuang *et al.* (2008) found that soaking temperature had a great role in reducing the cooking time and solid loss. Parboiling of paddy with an increase in soaking temperature to 40, 50 and 60°C reduced the cooking time from 14.59 to 14.53 and 14.33 min respectively.

Graham *et al.* (2015) reported that the interaction between soaking temperature and steaming time determines the cooking time. A steady increase in cooking time was observed for a soaking temperature less than 60°C and remained constant in between 60 and 70°C over a wide range of steaming time 5-15 min and increased slightly when the steaming time proceeds more than 15 min. when the soaking temperature exceeded 70°C, cooking time decreased from 23 to 21 min as steaming time increased from 5 to 10 min and then levelled off.

Pal *et al.* (2018) stated that parboiled milled rice had a cooking time ranging from 25 to 28 minute which was higher compared to the normal milled rice. This might be because due to parboiled milled rice took more time to absorb the water compared to the normal milled rice. Rockembach *et al.* (2019) evaluated the effect of microwave irradiation used for rapid parboiling on the morphological and physicochemical properties of rice grains and found that grains subjected to shortest irradiation times had shorter cooking times which may be due to the rapid water uptake caused by the rapid entry of water through the cracks and pores in the rice grain.

2.7.2 Water uptake ratio

Hashemi *et al.* (2005) studied the effect of cooking properties of aromatic rice with different drying air temperatures stated that the water uptake ratio decreased with the increase of drying air temperature up to 50⁰C and then increased with increase in drying air temperature. Higher drying temperature attributed to the separation of a particular size of starch from the kernels as residual loss.

Soaking temperature and soaking time had an effect on water uptake ratio (WAR). Increase in the soaking temperature increased the water absorption rate due to the decrease in diffusion resistance and due to the softening and expansion of grains (Kashaninejad *et al.*, 2007). The presence of cracks and high moisture gradient at the initial stage of soaking resulted in a sharp initial increase in water absorption rate. Patindol *et al.* (2008) stated that the water uptake ratio, volumetric expansion ratio, and gruel solid loss decrease during cooking. Water uptake of parboiled rice was higher than non-parboiled rice during cooking and it was mainly a function of soaking temperature.

2.7.3 Grain elongation ratio

Oko *et al.* (2012) done study on the physicochemical properties of cooked rice in the Nigeria state on different cultivar varieties and found that grain elongation ratio of the cooked rice of different varieties ranged from 1.08-3.20 mm with a mean value of 2.4±0.76 mm. The major characteristics of good rice were its linear elongation during the cooking process. They stated that lengthwise expansion without the increase in the breadth was considered to be a highly desirable quality grain.

The study conducted by Pal *et al.* (2018) on the effect of parboiling on phenolic, protein and pasting properties of rice from different paddy varieties reported that parboiled milled rice had a grain elongation ratio ranging from 6.78 to 10.81 which was higher than the normal milled rice (3.57 to 8.21) ratio.

2.7.4 Hardness

The outcome of the study done by Islam *et al.* (2003) on the effect of processing conditions on cooking qualities of parboiled rice showed that cooked parboiled rice was harder and less sticky than cooked raw rice. Rather than the cooking conditions, the drying conditions also greatly influenced the hardness of parboiled grains.

Patindol *et al.* (2008) stated that parboiling increased the hardness and decreased the stickiness of cooked rice. On cooking, parboiled rice became firmer and less sticky than non-parboiled rice. Kernels having cracks and break gains more water during parboiling causing higher softness in the cooked rice. The soaking process affects the textural properties such as hardness, adhesiveness, cohesiveness, gumminess, chewiness and springiness etc. The hardness as well as textural properties of cooked rice had improved with an increase in soaking temperature (Dutta and Mahanta, 2012).

The severity of the parboiling process increases the hardness of the cooked rice. Cooked parboiled rice had a harder texture than non-parboiled rice. The hardening of rice texture during cooking after a parboiling treatment was due to the thermal degradation of starch during heat treatment and reassociation of gelatinised starch after parboiling (Graham *et al.* 2015).

2.7.5 Gruel solid loss

Islam *et al.* (2001) reported that the gruel solid loss was depended on the cohesion of cooked parboiled rice. They were negatively correlated. High cohesion value led to a less sticky final product. This was due to the greater cohesion between the protein bodies and starch granules during parboiling.

Parboiling enabled the diffusion of water-soluble vitamins and nutrients into the endosperm and thus polishing of the parboiled rice didn't enable the loss of nutrients. The number of solutes leached into cooking water of raw milled rice was significantly higher than parboiled milled rice because of hydrothermal treatment. Parboiling resulted in a decrease in solubilisation of starch into cooking water (Pal

et al. 2018). The loss of solids in cooking water of the parboiled samples were in between 0.01 and 1.05g with a mean value of 0.23 ± 0.25 (Rockembach *et al.*, 2019).

2.8 OPTIMISATION OF PARBOILING PROCESS USING RESPONSE SURFACE METHODOLOGY

Bas and Boyaci (2007) stated that Response Surface Methodology (RSM) is a appropriate statistic technique widely used in the optimisation of food processes. This approach is useful for optimising, designing, developing, and improving processes where a response or responses are affected by several variables.

Danbaba *et al.* (2014) used the Response Surface Methodology (RSM) to study the effect of soaking temperature ($X_1 = 50, 60, \text{ and } 70^\circ\text{C}$), steaming time ($X_2 = 30, 40 \text{ and } 50 \text{ min}$) and drying time ($X_3 = 10, 15 \text{ and } 20 \text{ h}$) on head rice yield of parboiled paddy. Head rice yield of 78.89% was predicted for the optimum process condition such as $X_1 = 76.82^\circ\text{C}$, $X_2 = 23.18 \text{ min}$ and $X_3 = 11.70 \text{ h}$. The study showed that the drying time, quadratic coefficients of X_1 , X_3 and interaction coefficient X_1X_3 and X_2X_3 significant. RSM could be used to optimise the head rice recovery.

Yousaf *et al.* (2017) optimized the hydrothermal processing conditions of parboiling technique using RSM. Soaking temperature of 69.88°C , soaking time of 150 min and steaming time of 6.73 min were obtained as the optimised treatment combination for the predicted 73.43% HRY, 29.85 N hardness and 32.14 min cooking time with a composite desirability of 0.9658.

RSM could be used to determine the optimal conditions for the drying process based on several process responses such as water loss, solid grain, final moisture, colour and rehydration ratio. The statistical approach using RSM involves randomization, RSM modelling graphical presentation, modelling validity criteria

and validation of predicted optimum conditions adequately (Yolmeh and Jafari, 2017).

Ogunbiyi *et al.* (2018) optimised parboiling process using Response surface methodology with parboiling conditions such as the initial soaking temperature (IST), Soaking Time (ST) and the final moisture content (FMC) before the milling stage. The RSM optimised the parboiling conditions as 67.7°C IST, 13h 8 min ST and 12.7% FMC. These optimal conditions were expected to produce the parboiled milled rice with 70% Head Rice Yield, 74.7 N grain hardness and a colour value of 25.8.

2.9 COST ECONOMICS

Mishra and Das (2004) developed a CRRI mini modern paddy parboiling unit. It consists of a cylinder having two chambers separated by a perforated partition for soaking and steaming. The paddy undergone sun drying to reach the final moisture content 14%. The processing cost for parboiling 100 kg paddy in the mimi plant is calculated Rs. 30/- which was less by Rs. 10/- compared to traditional practice.

Roy *et al.* (2006) done a cost analysis of local parboiling processes practised in Malda district of West Bengal using in vessel, small boiler and medium boiler. The cost analysis was determined based on the net present worth (NPW), payback period and internal rate of return. The head rice yield was measured and its market value was assessed by a questionnaire. The parboiled rice produced under boiler process had a higher market value, but it required greater initial investment. The medium boiler consumed the lowest amount of energy compared to others. The local parboiling process could be improved in terms of energy consumption and market value of the rice by adopting the medium boiler process.

Shwetha *et al.* (2011), found that the total processing cost of paddy per quintal in Davangare district of Karnataka during 2005-'06 to 2009-'10 was Rs. 127.00 and Rs. 196.40 for traditional and modern mills respectively. Compared

to the modern rice mills, the cost of paddy processing in the traditional mills was almost 35% less.

Singha (2012) stated that the major share of paddy was processed by modern rice mills. The mill owners and farmers are made aware of the benefits of producing parboiled rice because it generates greater out-turn ratio compared to non-parboiled rice and the existing hullers be upgraded to modern hullers. It was slightly inconvenient for the individual farmers to go for parboiling before processing because small quantities or subsistence level paddy is processed in rural areas.

MATERIALS AND METHODS

Chapter III

MATERIALS AND METHODS

This research work was carried to develop a small scale parboiling cum drying unit for paddy processing. This chapter describes the materials and methods adopted for the fabrication and development of the above-said unit. Process parameters adopted and methodologies used for the quality evaluation of the milled and cooked rice are also affixed here.

3.1 DEVELOPMENT OF PARBOILING CUM DRYING UNIT

The components of the paddy parboiling cum drying unit consists of two cylindrical chambers having 100 kg capacity for the soaking cum steaming process, an LSU (Lousiana State University) dryer (200 kg/batch), bucket elevator, steam boiler, air blower and heating furnace. The soaking and steaming process of the paddy was done in the cylindrical chamber and the steam required for the steaming was provided by the steam boiler by firing the wood. The steamed paddy was conveyed to the bucket elevator via replaceable rectangular channel. The bucket elevator brought the paddy into the LSU dryer and the circulation continued until the parboiled paddy reached 13% moisture content. The continuous mixing type LSU dryer with inverted Vshaped channels was designed with capacity of 200 kg/batch and the heat required for the drying was provided through the heating furnace. The blower fan was provided to enhance the convective heat transfer inside the drying chamber. The parboiling cum drying unit was fabricated using SS 304 material.

3.2 SPECIFICATIONS OF THE PARBOILING CUM DRYING UNIT

The different components of the paddy parboiling unit are

- Soaking cum steaming chamber
- LSU dryer
- Bucket elevator
- Steam boiler

- Heat furnace
- Air blower

The detailed specifications of the unit are computed in the table 3.1 and its isometric view, front view, right side view and top view are given in the Fig. 3.1, 3.2, 3.3 and 3.4 respectively.

Table 3.1 Specifications of the parboiling cum drying unit

Sl. No.	Components	Specifications
1	Soaking cum Steaming chamber <ul style="list-style-type: none"> • Capacity • Numbers a. Cylindrical tank <ul style="list-style-type: none"> • Height • Diameter b. Lower conical portion <ul style="list-style-type: none"> • Upper diameter • Lower diameter • Height c. Inner pipe <ul style="list-style-type: none"> • Height • Diameter 	100 kg/ tank Two 830 mm 400 mm 400 mm 130 mm 210 mm 660 mm 32 mm
2	LSU Dryer <ul style="list-style-type: none"> • Dimensions of rectangular drying chamber • Number of inverted channels • Channel dimensions <ul style="list-style-type: none"> a. Length 	700 x 700 x 780 mm 32 channels (16 channels act as air inlets and 16 act as air outlet channels) 690 mm
3	Bucket elevator <ul style="list-style-type: none"> • Capacity • Bucket Size • Bucket spacing on belt 	500 kg/h 152 mm 101 mm
4	Steam boiler <ul style="list-style-type: none"> • Dimensions <ul style="list-style-type: none"> i. Outer diameter 	1950 mm

	<ul style="list-style-type: none"> ii. Inner diameter iii. Height <ul style="list-style-type: none"> • Available capacity • Required capacity 	1290 mm 890 mm 2 kg/cm ² 1 kg/cm ²
5	Heat furnace <ul style="list-style-type: none"> • Dimensions 	708 x 806 mm
6	Motor power <ul style="list-style-type: none"> • Motor for the dryer • Motor for the bucket elevator • Motor for the air blower 	0.5 hp 1 hp 0.5 hp
7	Material for construction	SS 304 sheet

3.2.1 Soaking cum steaming chamber

The soaking cum steaming unit consists of two vertical SS cylindrical drums of 400 mm diameter and 830 mm height each having 100 kg capacity as shown in figure 3.3. The two cylindrical drums are placed 150 mm apart from each other. The bottom portion of the cylindrical drum is conical shape with a height of 260 mm, bottom radius of 65 mm, and an upper radius same as that of cylindrical drum. A central pipe having diameter of 32 mm and 660 mm height with equally spaced ports is fitted inside the cylindrical chamber for the uniform distribution of steam. It is connected to the steam boiler through a pipe having a diameter of 36 mm from the upper side of the chamber. A rectangular sliding plate is provided at the bottom of the two cylindrical drums for discharging the paddy to the bucket elevator. For the soaking, the paddy is filled inside the cylindrical chamber along with the required amount of water. After the completion of soaking, water is drained out with the help of drain valve. Soaked paddy is subjected to steaming at a pressure of 1 kg/cm² through the centrally placed main pipes. The paddy grains were covered by a wetted gunny bag before starting the steaming process. The covering prevented

the escaping of steam thereby created a partial pressure over the content that aid in the inward movement of water molecules into each gelatinous kernel.

3.2.2 LSU Dryer

LSU dryer is a continuous mixing type dryer developed by Louisiana State University in the mid-1950, specifically for the rice drying to ensure gentle treatment, good mixing and air to grain contact. The sectional view of the LSU dryer is shown in figure 3.5. It consists of a square chamber of SS grade 304 material, holding bin, blower with duct, grain discharging mechanism, and air heating system. The square-shaped drying chamber having dimensions 700 x 700 x 1465 mm is installed with layers of 32 numbers of inverted V-shaped channels made of stainless steel (1.6 mm) placed at 500 mm below the top portion of the drying chamber (Figure 3.5). The inverted V channel is made of SS material and the sides of the V channel has dimension of 65 mm with an inclination angle of 120°. Alternate V-shaped channels are air inlet and outlet channels which are arranged one below the other in an offset pattern. Each layer of the port consists of a two full-size ports and two half-size ports. All ports are of the same size arranged in equal spacing. The bucket elevator brings the grain to the top inverted V layer in the drying chamber through an inclined placed cylindrical duct from the elevator to the drying chamber. Two ribbed rollers are provided at the bottom of the drying chamber for the discharge of grain. A rectangular open channel is provided from the soaking cum steaming chamber to the bucket elevator for the easy conveyance of grains into the bucket elevator.

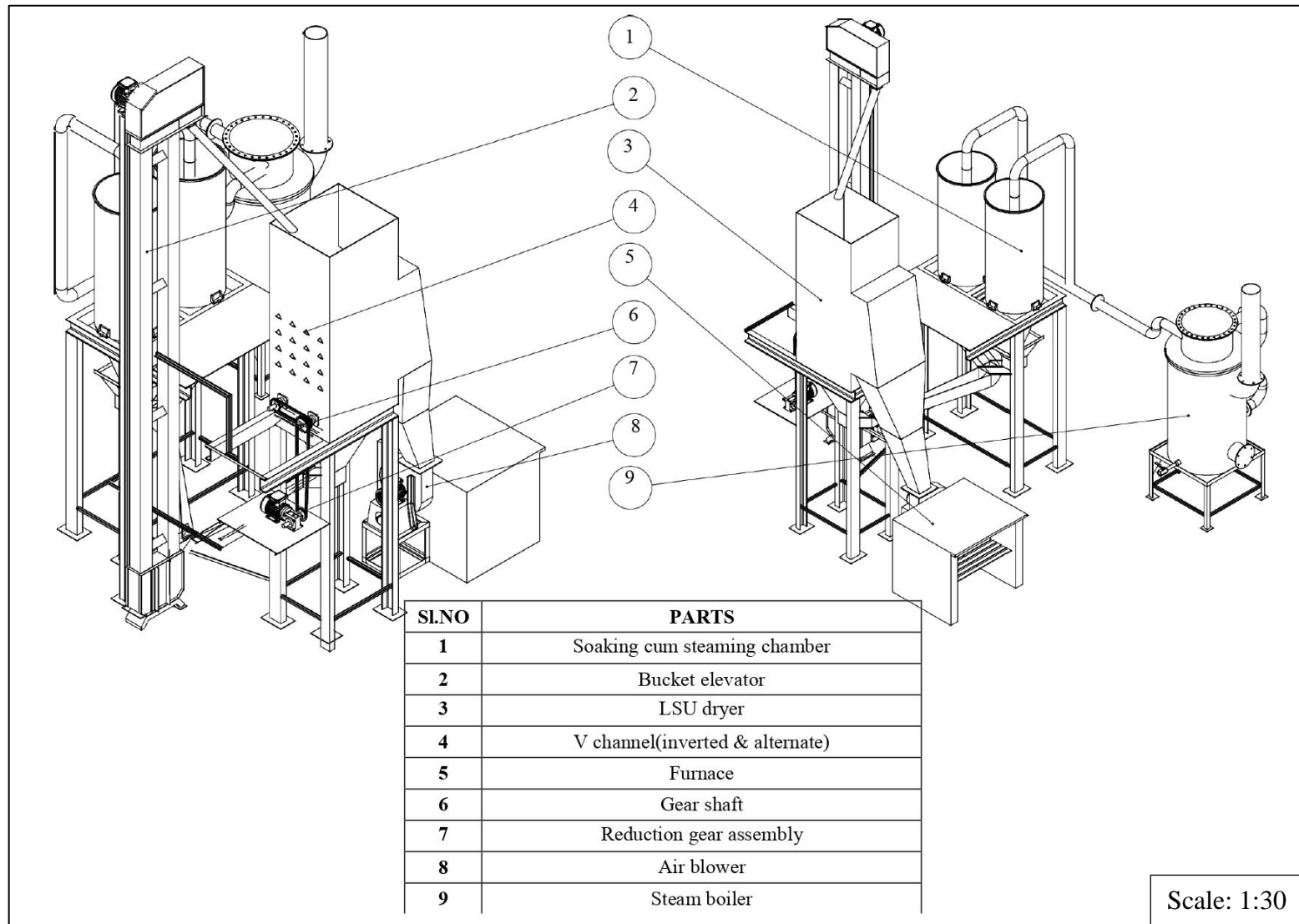

Figure 3.1 Isometric view of the parboiling cum drying unit

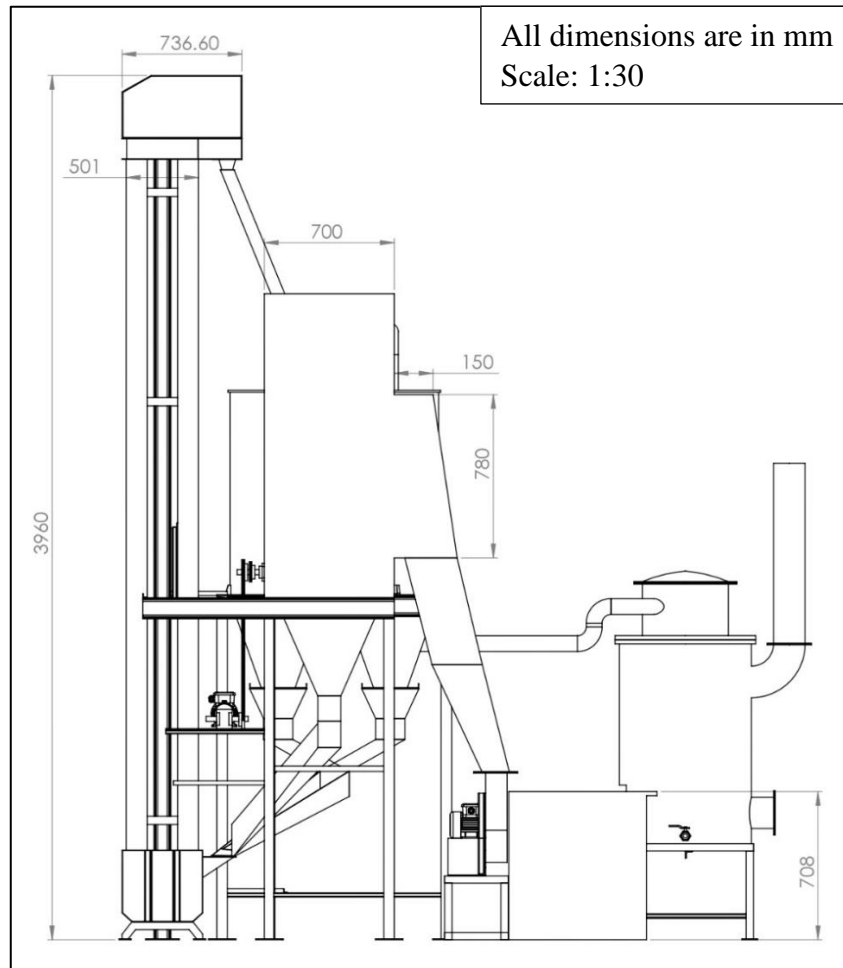

Figure 3.2 Front view of the parboiling cum drying unit

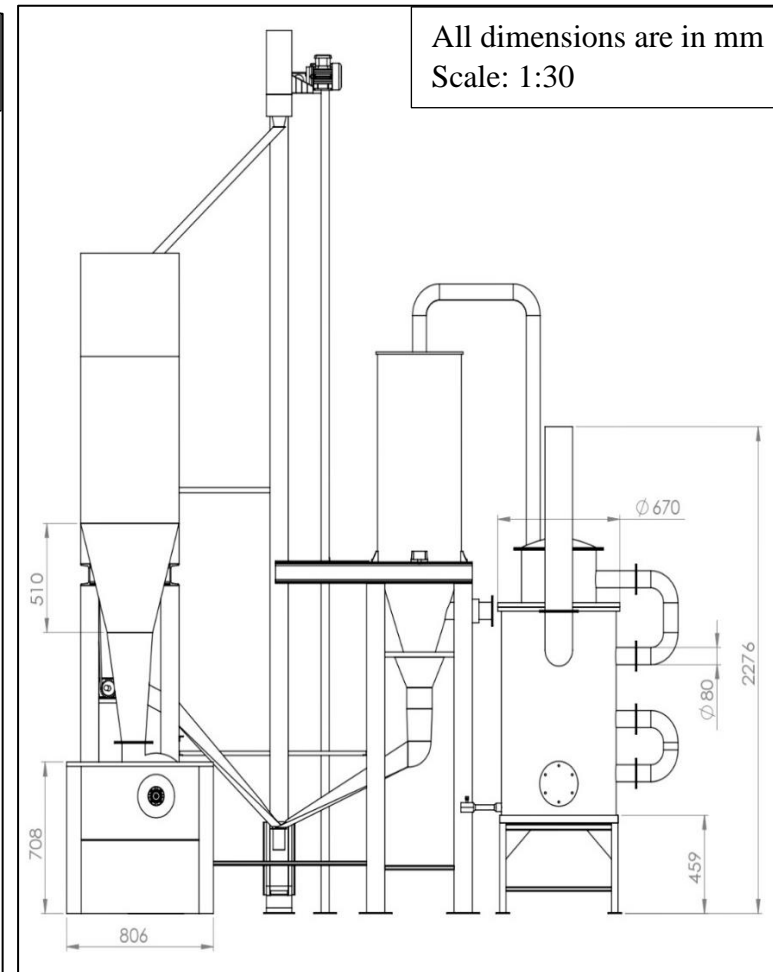

Figure 3.3 Right side view of the parboiling cum drying unit

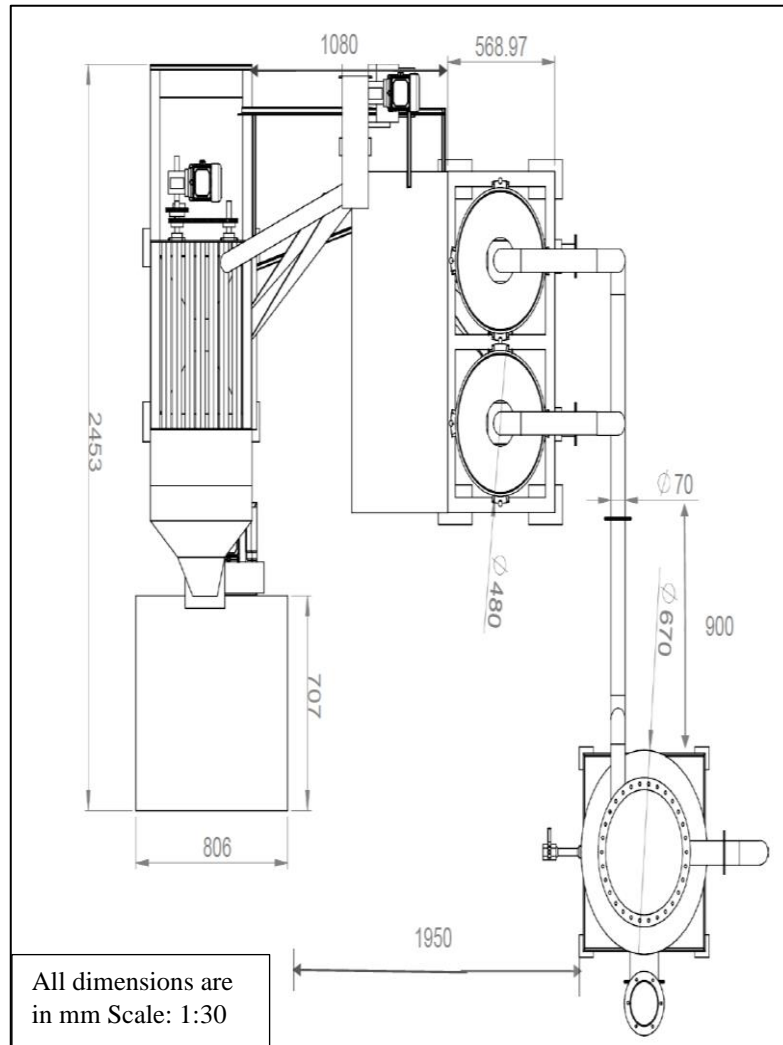

Figure 3.4 Top view of the parboiling cum drying unit

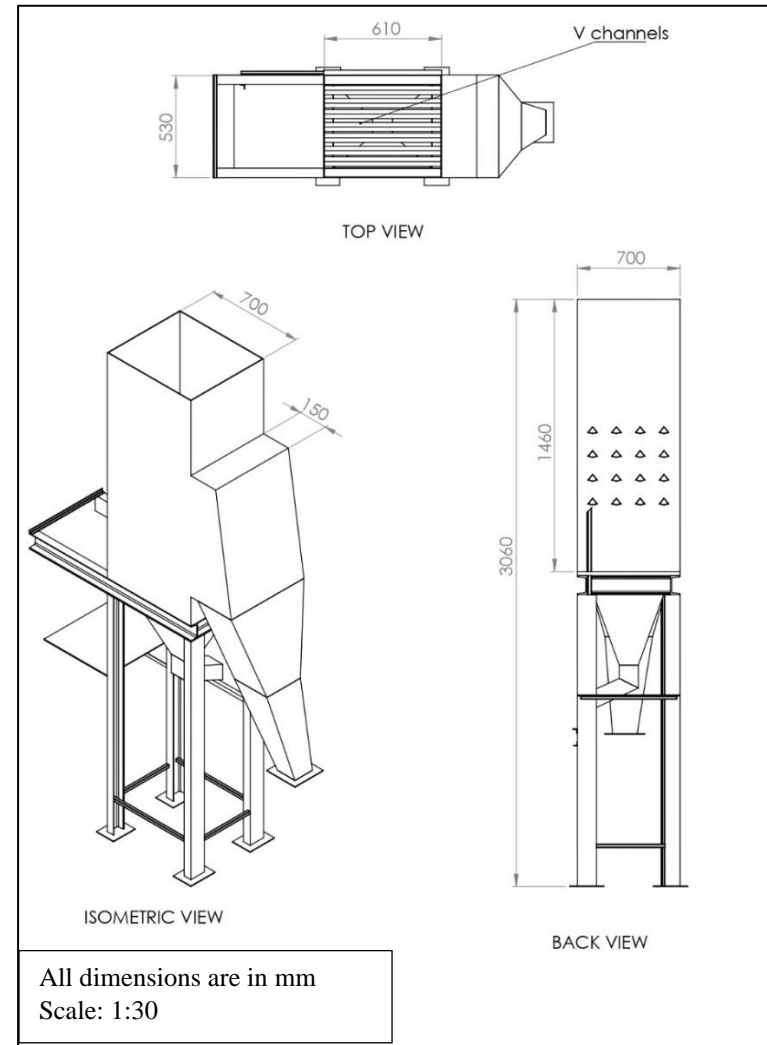

Figure 3.5 Sectional view of the LSU dryer

3.2.3 Steam boiler

The task of any steam boiler is to provide the correct amount of steam at the appropriate pressure. The boiler was fabricated with 16 gauge mild steel sheets and steam was generated by the combustion of fuel in a furnace, the produced heat was transferred to water in the boiler shell, which then evaporated to produce steam under pressure. The designed boiler as shown in figure 3.3 is a vertical cylinder having a length of 890 mm and outer diameter of 190 mm. It is raised 460 mm from above the ground level for maintaining the height between the boiler and the soaking cum cylindrical chamber. The actual pressure of the steam boiler is 2 kg/cm^2 and working pressure was 1 kg/cm^2 during the parboiling process. A pressure relief valve is attached at the top of the boiler to release the excess pressure from the boiler unit. Also, separate ports are attached on the sides of the boiler unit for the inflow and outflow of water. The steam boiler weighing about 60 kg was made of stainless steel and is supported on a rectangular framework made of mild steel. The burner is fitted on the underside of the boiler unit and can be used as either a gas burner or can be fired using firewood.

The half of the boiler was filled with water by leaving a vacuum at the upper part of the boiler for sufficient steam generation. The heat was supplied to the boiler through firing the firewood and the heat generated was used to raise the temperature of the water until the water begins to boil vigorously for the formation of sufficient steam. The generated steam at a pressure of 1 kg/cm^2 was channelled through interconnecting pipes to the soaking cum steaming tank for the process of steaming.

3.2.4 Bucket elevator

A bucket elevator is a vertical conveying equipment having a height of 3960 mm which was used for the vertical transport of the bulk paddy grains. It is shown in Fig. 3.2. It mainly consists of buckets of 152 mm size attached to moving belt. The buckets are attached to a nylon synthetic food grade belt having width of 140 mm by

providing a space of 101 mm in between two buckets. The bucket elevator connects the steaming chamber with the LSU Dryer and it helps to complete the drying process uniformly by continuously carrying the paddy from the bottom to the top of the dryer. The bucket elevator consists of a series of three millimetre thickness round bottom nylon white cup (bucket) mounted on an endless belt. The belt operates over two pulleys at the head and foot of the elevator having a capacity of 500 kg/h. The capacity of bucket elevator was fixed as 500kg/hr, considering the possibility of future expansion. The head pulley is attached to a head shaft rotating with 100 rpm. The head shaft is connected to a one hp motor. The buckets attached to the belt lift the paddy grain from the pile of paddy at the foot of the pulley and discharged into the discharging chute by passing over the head wheel at the top of the elevator. The elevator was equipped with finger gripped pulleys. The range of speed of the belt is 1.0 to 1.3 m/s.

3.2.5 Blower

The main purpose of the blower is to transfer the hot air from the heat furnace to the rectangular drying chamber. The selection of blower is based on the total volumetric flow rate of air per second through the inlet ports. The blower attached inside the heat furnace provides hot air to the drying chamber. Hot air was forced through the air inlet ports into the chamber with air flow rate of 0.047 m³/s. The blower was operated with 0.5 hp motor.

3.2.6 Heat Furnace

A rectangular two-stage heat furnace was installed to provide heat through hot air to the interior space of the LSU drier as shown in Plate 3.7. The hot air was generated by burning the firewood. The blower opening was attached to the first layer of two stage heating furnace and the remaining ash and the small unburnt firewood fell into the second stage of the heating furnace.



Plate 3.1 Parboiling cum drying unit



Plate 3.2 Soaking cum steaming chamber



Plate 3.3 LSU dryer



Plate 3.4 Conveying channels



Plate 3.5 Air Blower

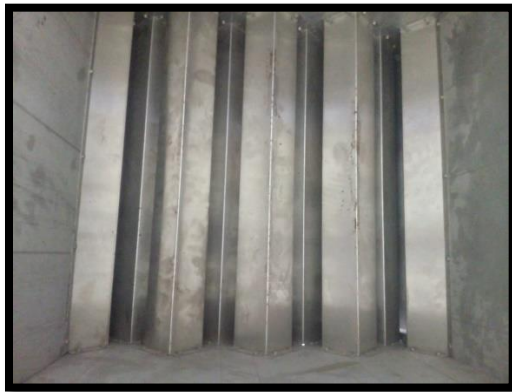

Plate 3.6 Inverted V channels



Plate 3.7 Heat Furnace

3.3 PERFORMANCE EVALUATION OF DEVELOPED PARBOILING CUM DRYING UNIT

The performance of the developed parboiling cum drying unit was evaluated by comparing the milling and cooking qualities of the paddy. Parboiling was carried out at three different soaking time, steaming time and drying temperatures.

Milling qualities of parboiled rice such as, milling efficiency, head rice yield, hardness, colour, bulk density, true density and chalkiness, cooking qualities such as cooking time, water uptake ratio, gruel solid loss, grain elongation ratio and hardness of cooked rice were evaluated.

3.3.1 Raw Material Procurement

Properly cleaned paddy of crop variety *Jyothi* was procured from the Department of Seed Science and Technology, College of Horticulture, Kerala Agriculture University, Thrissur. The collected sample was washed with water for removing the stones and debris before starting the trials.

3.4 STANDARDISATION OF SOAKING TIME, STEAMING TIME AND DRYING TEMPERATURE

The three major steps of parboiling are soaking, steaming and drying. The quality of the parboiled paddy depends mainly on these three parameters. Soaking helps to achieve uniform hydration in the paddy grain. Traditionally the soaking was carried in cold water for two to three days. As this could cause an off flavour for the soaked paddy, the duration of soaking was reduced by rising the temperature of soaking water (Igathinathane *et al.*, 2005). In addition, since soaking of paddy at 75°C (CFTRI Method) and allowing the paddy to cool naturally ensured the fastest possible hydration without complication (Sahay and Singh, 2001), two methods of soaking, *ie.*, hot soaking and cold soaking were followed in this study. The process flow chart for the

development and performance evaluation of the parboiling cum drying unit is given in the Fig. 3.6.

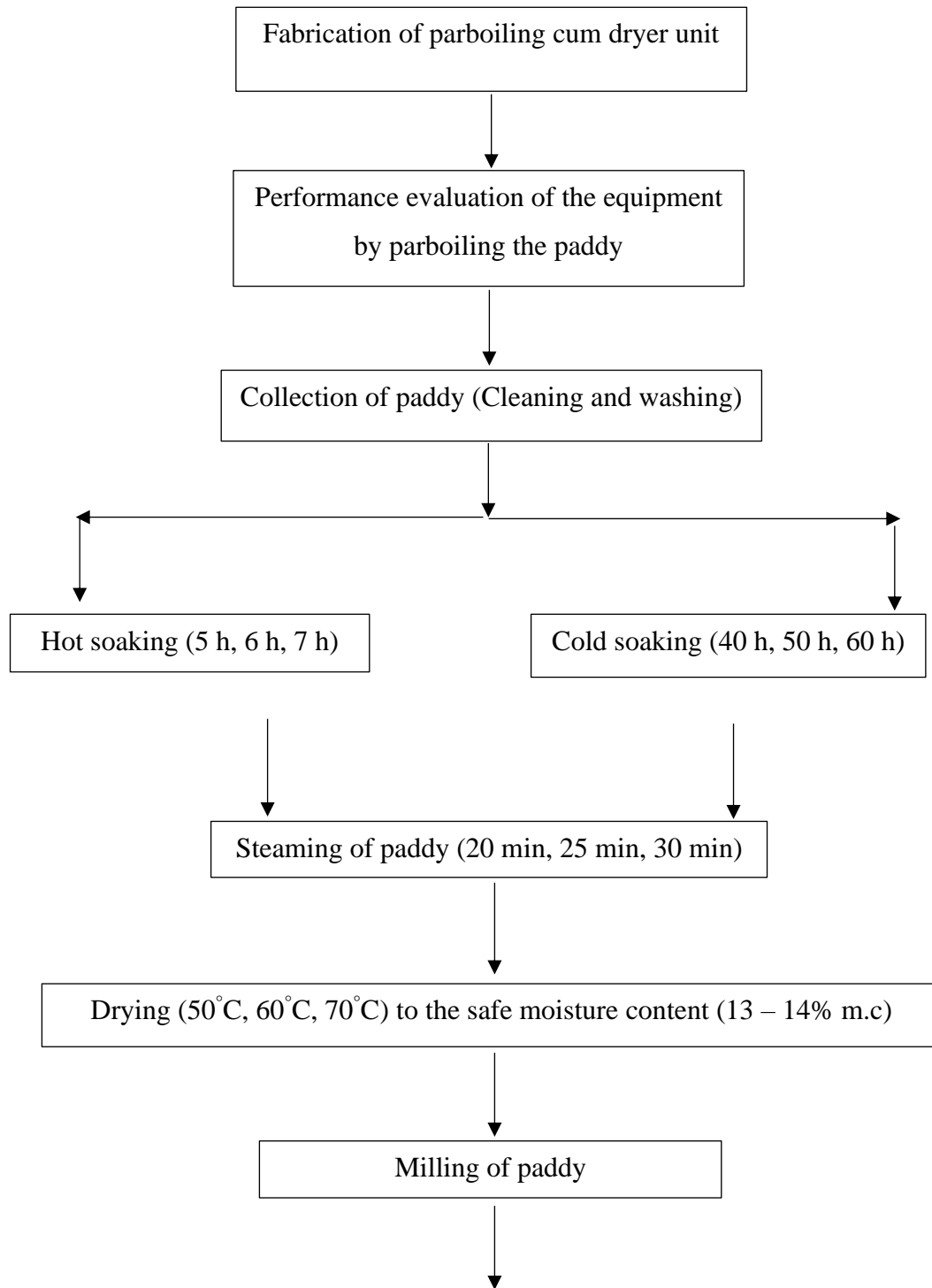

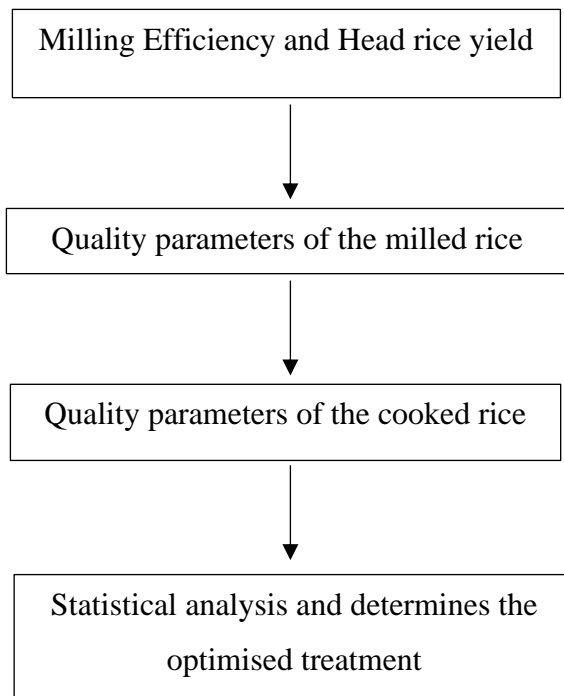

Fig. 3.6 Process flow chart for parboiling of paddy

Based on the preliminary studies and reviews available, the soaking time (for both hot and cold soaking), steaming time and drying temperature (50, 60, and 70⁰C) were selected. Treatment combinations for cold soaking and hot soaking were selected based on Response surface methodology (RSM). The 17 treatment combinations for cold and hot soaking methods following the RSM are given in tables 3.2 and 3.3.

Table 3.2 Treatment combinations in hot water soaking

Run	Soaking time (h)	Steaming time (min)	Drying temperature (°C)
1	5	20	60
2	7	20	60
3	5	30	60
4	7	30	60
5	5	25	50

6	7	25	50
7	5	25	70
8	7	25	70
9	6	20	50
10	6	30	50
11	6	20	70
12	6	30	70
13	6	25	60
14	6	25	60
15	6	25	60
16	6	25	60
17	6	25	60

Table 3.3 Treatment combinations in cold water soaking

Run	Soaking time (h)	Steaming time (min)	Drying temperature (°C)
1	40	20	60
2	60	20	60
3	40	30	60
4	60	30	60
5	40	25	50
6	60	25	50
7	40	25	70
8	60	25	70
9	50	20	50
10	50	30	50
11	50	20	70

12	50	30	70
13	50	25	60
14	50	25	60
15	50	25	60
16	50	25	60
17	50	25	60

3.5 PARBOILING EXPERIMENT

3.5.1 Soaking

Soaking of paddy was carried out in soaking cum steaming chamber given in plate 3.2. Cleaned paddy were filled into stainless cylindrical tanks with paddy to water ratio of 1:2 as suggested by Manful *et al.* (2009). The cold soaking method of parboiling consists of keeping the paddy in normal water for 40h, 50h, and 60h. The hot soaking method of parboiling consists of soaking the paddy grains at the same grain to water ratio at a temperature of 70°C with soaking time of 5 h, 6 h and 7 h. Initially, the temperature of soaking water was around 80°C and it was lowered to 70°C when it was filled with paddy. The paddy was stirred at regular intervals to ensure uniform soaking. After the desired soaking duration, the water from the tanks was drained out. The soaked paddy was subjected to steaming in the same tank itself.

3.5.2 Steaming

Steaming was also done in the soaking cum steaming chamber. The soaked paddy remained was subjected to the steam at high pressure of 1 kg/cm² which generated from the steam boiler. Steaming duration of 20 min, 25 min and 30 min was followed for both hot and cold soaked paddy. During the steaming process, a water-soaked jute bag was kept over the paddy for not allowing the generated steam to escape from the paddy.

3.5.3 Drying

The steamed paddy was conveyed into the LSU dryer for drying it to the safe moisture content required for milling through bucket elevator. The elevator conveyed the paddy into the holding bin of the LSU dryer. This paddy passed through the layers of inverted V-shaped channels installed in the drying chamber. The grain discharge was done through the action of ribbed rollers provided at the bottom of the drying chamber. The hot air from the husk fired heat furnace entered into the drying chamber through a blower. The alternate layers of V channels act as air inlet and outlet channels. The temperature of heated air from the furnace gets reduced when it enter the drying chamber through the inlet ports and it was used for the drying of paddy grains. The hot air from the dryer was exhausted through the alternate layers of outlet ports. The paddy was recirculated through the bucket elevator to achieve desired moisture content for milling. The moisture content of paddy was tested by using universal soil moisture meter.

The variable involved in the drying was the temperature of hot air. The main drawback of firewood heating furnace was control of temperature. Hence, it was difficult to determine the best temperature for drying of parboiled paddy. Therefore, drying step was carried out in the hot air convection type dryer at different temperature. After optimizing the temperature for drying, the final experiment was conducted with the LSU dryer.

3.5.4 Milling of the parboiled paddy

Rice milling is the process of producing the white rice by removing the husk and bran layer. In the present study, the parboiled paddy was subjected to milling process with a laboratory-scale huller (Model MRM04 Maruthi Engineering works) having a capacity of 100 kg/h. Paddy milling yields, milled rice from main outlet and mixture of bran and outer husk in another outlet. Milled parboiled rice was used for quality evaluation.

3.6 MILLING QUALITIES OF THE PARBOILED PADDY

The qualities of milled parboiled rice were determined by evaluating the milling efficiency and Head rice yield. (Sahay & Singh, 2011).

3.6.1 Milling efficiency

The main aim of milling is to achieve maximum head rice with minimum broken. It has a great importance in the rice industry. So the efficiency of milling was calculated using the given Eq. 3.1..

$$\begin{aligned} \text{Milling efficiency, \%} \\ &= \text{Coefficient of hulling} \times \text{coefficient of wholeness} \times 100 \\ &\dots\dots\dots(3.1) \end{aligned}$$

$$\text{Coefficient of hulling} = \frac{\text{weight of brown rice}}{\text{weight of paddy fed to machine}} \times 100 \dots\dots\dots(3.2)$$

$$\text{Coefficient of wholeness} = \frac{\text{weight of brown head rice}}{\text{weight of total brown rice}} \times 100 \dots\dots\dots(3.3)$$

3.6.2 Head Rice Yield

Head rice yield is the weight percentage of head rice (excluding the broken grains less than 3/4th of their length) obtained from the paddy. The head rice yield was determined by Eq. 3.4 (Sahay and Singh, 2001).

$$\begin{aligned} \text{Head Rice Yield (HRY) (\%)} &= \frac{\text{weight of whole grains}}{\text{weight of milled parboiled rice}} \times 100 \\ &\dots\dots\dots(3.4) \end{aligned}$$

3.6.3 Hardness of milled parboiled rice

The method suggested by Islam *et al.*(2002) was followed for evaluating the hardness of milled parboiled rice. Six grains of parboiled rice were randomly selected and the hardness of the uncracked grains were measured using the compression test by using texture analyser (TA.XT texture analyser, stable micro systems Ltd. UK). Texture analyzer gave a three-dimensional product analysis by measuring distance, force and time. Force was measured against set distance and the distance was measured to achieve set of forces. Cylindrical probe with 2 mm diameter compressed the sample which kept on the base of the instrument.

A brown rice grain was put on the sample table attached to the load cell and its hardness value was measured in a flat position. A 500 N load cell, probe of 2 mm diameter and 0.1 mm/s compression rate were used. The average hardness value of 6 determinations were expressed as Newton (N) in the present study.

3.6.4 Colour of milled parboiled rice

The Hunter's lab flex colourimeter (made by Hunter Associates Laboratory, Reston, Virginia, USA) was used to determine the colour of milled and cooked parboiled rice. The principle of working is by focusing the light and measuring energy reflected from the sample across the entire visible spectrum. The colourimeter has filters that rely on "standard observer curves" that measure the amount of red, yellow, green, and blue colours. The colour of the rice was measured under a colourimeter scale at a 10° observer and illuminate at D65. The instrument was initially calibrated with a black tile and white tile provided with the instrument for further colour measurements.

The 3-dimensional scale L^* , a^* and b^* values was used in the present study. The luminance (L^*) forms the vertical axis, which indicates a light-dark spectrum with a range from 0 (black) to 100 (white). In the same way, a^* indicates the green - red spectrum with a range of - 60 (green) to + 60 (red), and b^* indicates the blue-yellow spectrum with a range from - 60 (blue) to + 60 (yellow) dimensions respectively (Roy

et al., 2003). Besides, Chroma (B) was calculated from the value of 'a*', and 'b*'. Chroma indicates colour saturation of the samples which varies from dull (low value) to vivid colour (high value).

$$Chroma, (B) = \sqrt{(a^*)^2 + (b^*)^2} \dots\dots\dots(3.5)$$

Where,

a^*, b^* = colour coefficient for milled parboiled rice.

The colour of the milled parboiled rice was measured by filling the rice sample in the transparent cup without any void space at the bottom. Thus the colour value of the samples was obtained as L^*, a^* and b^* values.

3.6.5 Bulk density and true density of milled parboiled rice

Bulk density (ρ_b) and true density were measured by following the procedure reported by Himjyoti (2016). For determining the bulk density, the milled parboiled rice was filled in a measuring cylinder up to a known volume and the top level was adjusted by gentle tapping. The weight of the filled grains was determined and ρ_b was calculated using the Eq. 3.6.

$$\rho_b \text{ (g/cm}^3\text{)} = \frac{\text{mass of grain}}{\text{volume occupied}} \dots\dots\dots(3.6)$$

The true density (ρ_t) in g/cm³ is defined as the ratio of the weight of the sample to its true volume. It was determined by the toluene displacement method. Milled parboiled rice of known weight was dipped in a known volume of toluene taken in a measuring cylinder. To release any possible air gap present in the rice, the cylinder was gently agitated. The volume of toluene displaced by the rice was then recorded and the ρ_t was calculated using the Eq. 3.7.

$$\rho_t \text{ (g/cm}^3\text{)} = \frac{\text{mass of grain}}{\text{volume of toluene displaced}} \dots\dots\dots(3.7)$$

3.6.6 Chalkiness of milled parboiled rice

Chalky rice is defined as the rice kernel having a white opaque center in its endosperm. The amount of chalkiness greatly affects the grain appearance which largely determines the endosperm opacity. Chalkiness was found out by following the method suggested by IRRI (2009). Hundred head rice were randomly selected from each trial and visually assessed for chalkiness. According to the standard evaluation systems of International Rice Research Institute, a score of 1 (less than 10% chalkiness), 5 (10 to 20% chalkiness) or 9 (over 20% chalkiness) were given to each sample based on the percentage.

3.7 COOKING PROPERTIES OF PARBOILED PADDY

3.7.1 Cooking time

Cooking tests were carried out by using a boiling water bath. The time needed for cooking the parboiled milled rice was determined by the method followed by Roseline *et al.* (2010). Five grams of milled rice of each treatment was taken and poured into 135ml of vigorously boiling distilled water in a 400ml beaker and covered with a watch glass over it. After 15 mins of boiling, 10 grains were pressed between two petri dishes. The grains were considered cooked when at least nine out of the 10 grains had no longer opaque centers and the corresponding time were recorded.

3.7.2 Water uptake ratio (WAR)

Water uptake ratio is the amount of water absorbed by a known quantity of rice that was kept in a boiling water bath. This test was conducted with the reference to the work done by Sindhu *et al.* (1975). Five gram of rice (W_1) was taken in 135 ml of water in a 400 ml graduated cylinder which was kept in a boiling water bath. After cooking, it was allowed to cool and water uptake ratio was determined by weighing the cooked rice (W_2) after decanting its surface water using a blotting paper. The WAR can be calculated using the Eq. 3.8.

$$\text{Water uptake ratio} = \frac{(W_2 - W_1)}{(W_1)} \dots\dots\dots(3.8)$$

W_1 = weight of the parboiled rice

W_2 = Weight of the cooked rice

3.7.3 Gruel solid loss

Amount of solids leached from the kernel to the surrounding water during cooking is termed as gruel solid loss. The method followed by Sareepuang *et al.* (2008) was used to determine the gruel solid loss. Five grams of rice were cooked in 135 ml of distilled water in a 400ml beaker placed in a boiling water bath. The rice water agitated well after removing the cooked parboiled rice. Twenty five ml of previously well agitated sample was placed in a pre-weighted petridish and air dried in an oven for 105⁰C for 1h. Later the sample was fully dried until a constant weight at the same temperature in the presence of P₂O₅ dessicant. The weight of the dried sample was taken and calculate the actual amount of dried matter 135ml of rice water. The amount of solids leached was calculated as grams of solids per grams of dry grain.

3.7.4 Grain elongation

Elongation of cooked rice was determined by measuring the initial length (L_0) of parboiled rice before cooking and the final length (L) of cooked rice after cooking (Sareepuang *et al.*, 2008). The grain elongation ratio was calculated using the Eq. 3.9.

$$\text{Grain elongation} = L_1 - L_0 \dots\dots\dots(3.9)$$

Where

L_0 = Initial grain length before cooking

L_1 = Final length after cooking

3.7.5 Hardness of cooked rice

Hardness of cooked rice kernels were evaluated using a texture analyser (TA.XT texture analyser, stable micro systems Ltd. UK). The procedure followed by Graham *et al.* (2015) was adopted in the present study. Twenty five milled head rice were washed with clean water and placed in a glass beaker containing 20 ml of water. Beaker containing samples was placed in a boiling water bath for 20 minutes. The cooked rice kernels after draining were transferred to the petridishes lined with filter paper to further drain the kernels. Three cooked parboiled rice grains were put in the center of the sample platform's grid of the texture analyser. To compress the rice kernel to 90% deformation, a cylindrical probe having a diameter of 10 mm was used at a pretest speed of 0.5 mm/s and post test speed of 1 mm/s was adopted. The average values of hardness was calculated from the procured force- deformation data.

3.8 STATISTICAL ANALYSIS

Statistical analysis was carried out to study the effect of independent parameters on all the dependent variables. Analysis of variance (ANOVA) was conducted with the Response Surface Methodology (RSM) Box-Bhenken Design for optimisation of different parameters involved in this study. The experimental design was performed using the Design-Expert software version 12.0.

3.9 COST ECONOMICS

Based on the capital cost of machineries and variable costs, the processing cost of one kilogram of parboiled paddy was calculated. The cost economics was carried out following the standard procedure.

RESULTS AND DISCUSSION

Chapter IV

RESULTS AND DISCUSSION

This chapter deals with the results and discussion on the development and performance evaluation of parboiling-cum-drying for the paddy crop variety *Jyothi*. Quality parameters of the milled rice and cooked rice were enumerated and discussed in this chapter.

4.1 TESTING OF THE DEVELOPED PARBOILING CUM DRYING UNIT

The fabricated parboiling cum drying unit majorly consists of two soaking cum steaming cylindrical chambers having a capacity of 100 kg each and a continuous recirculating LSU dryer. The two units were fabricated using SS 304 sheet and the steam required for the parboiling was supplied by the steam boiler. The air for drying the paddy was heated using a furnace and supplied through the air blower. The steamed paddy was conveyed into the LSU dryer with the help of bucket elevator. The performance of the unit was evaluated by comparing the head rice yield and milling efficiency of the parboiled paddy which had gone through hot soaking and cold soaking processes varying in soaking time, steaming time and drying temperature. The quality parameters such as hardness, chroma value, chalkiness, bulk density and true density of the parboiled milled rice, and the cooked rice qualities like cooking time, water uptake ratio, gruel solid loss, grain elongation ratio and the hardness were evaluated in this study. The suitable combinations of independent parameters for the paddy parboiling in the fabricated unit were optimized based on the statistical analysis.

4.2 STANDARDIZATION OF THE PARBOILING TREATMENT

The paddy parboiling consists of three major steps such as soaking, steaming and drying. The treatment combinations for the research were standardized by referring to the preliminary studies related to the parboiling process. The collected paddy after

the sorting and cleaning, was subjected to two different soaking process *ie.*, cold soaking (40 h, 50 h and 60 h) and hot soaking (5 h, 6 h, and 7 h) (Gunathilake, 2018). Later it was subjected to steaming in different duration (20, 25 and 30 min) (Igathinathane *et al.*, 2005). The two consecutive steps were done on the same cylindrical tank. The required air temperature for heat furnace based LSU dryer was fixed according to the optimum temperature obtained from hot air tray dryer. Therefore, after steaming, the steamed paddy was dried at three drying temperatures (50, 60, and 70°C) in a hot air dryer (Zheng and Lan, 2007). The experiment was carried out with 17 treatments in both cold soaking and hot soaking. As discussed under 3.6, the effect of varying parameters on the milling and cooking qualities of parboiled rice were studied for the performance evaluation of the developed unit. The milling qualities selected were milling efficiency, head rice yield, hardness, bulk density, true density and chalkiness of the milled parboiled rice. Cooking time, water uptake ratio, grain elongation ratio, hardness and gruel solid loss were the cooking qualities. In the present study, the treatments are fixed based on the response surface methodology (BOX Behnken design).

4.2.1 Effect of parboiling on milling efficiency

Milling is the production of rice in its whole grain form by removing the husk and bran layers. It preserves the rice kernels in its appropriate original shape. The effect of various process parameters of parboiling on milling efficiency in hot soaking and cold soaking is shown in Fig. 4.1 and 4.2. It was revealed that the variation in steaming time and drying temperature had significant effect on the milling efficiency (Appendix A2 and B2). Bhattacharya and Rao (1966) reported that the milling quality of rough rice showed a striking improvement through the parboiling treatment. From table 4.1, it could be noticed that in hot soaking, maximum efficiency value of 66.7% was observed for paddy parboiled with a soaking duration of 7 h, steaming time of 25 min and drying air temperature of 50°C and a minimum value of 49.01% was observed for a soaking duration of 5 h, steaming time of 30 min and drying temperature of 60°C. In

cold soaking, the highest milling efficiency of 64.49% was found for a soaking duration of 40 h, steaming time of 25 min and drying temperature of 50°C and lowest value 48.26% was found for the soaking duration of 60 h, steaming time of 30 min and drying temperature of 70°C.

The variation of soaking time showed a slight difference in the milling efficiency and statistically it was not significant (p value > 0.05) as shown in the ANOVA table given in Appendix A2 and B2. This might be due to the sufficient absorption of moisture required for the complete gelatinization during soaking (Mohanty *et al.*, 2002). In cold soaking, the rice husk might be split due to the long duration of soaking and it led to the leaching and deshaping of the rice. Hot soaking enabled the paddy to reach their optimum moisture contentment within a short duration. It improved the milling properties of hot soaking (Miah *et al.*, 2002). From the Fig. 4.1 and 4.2, in both the cases (hot soaking and cold soaking), the milling efficiency increased with increase in steaming time from 20 to 25 min. However, further increase in steaming time resulted decreased milling efficiency. Similar trend was observed by Islam *et al.* (2002) in their study on the effect of processing conditions on physical properties of parboiled rice. It might be due to the severe deformation of the grain along with the exudation of endosperm due to the husk splitting and absorption of excessive moisture content. On further steaming for longer duration, the deformed grain loses the exuded part of the endosperm reducing the milling yield.

Figures 4.1 and 4.2 shows that the milling efficiency decreases with increase in the drying temperature in both hot soaking and cold soaking methods. It might be due to the development of steep moisture gradient developed between the surface and the center of the kernel that cause internal stress during the rapid drying. The kernel released these stress by cracking and these cracks were irreversible which set up lines of weakness that aids in the development of fractures under mechanical stress during milling (Bhattacharya and Swamy, 1967).

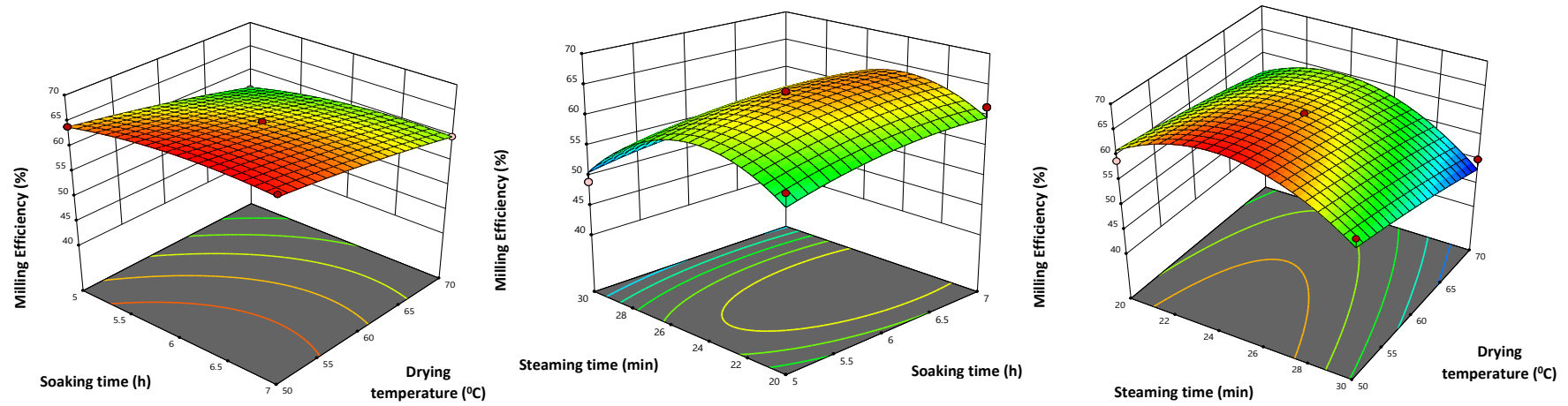

Fig. 4.1 Effect of parboiling on milling efficiency in hot soaking

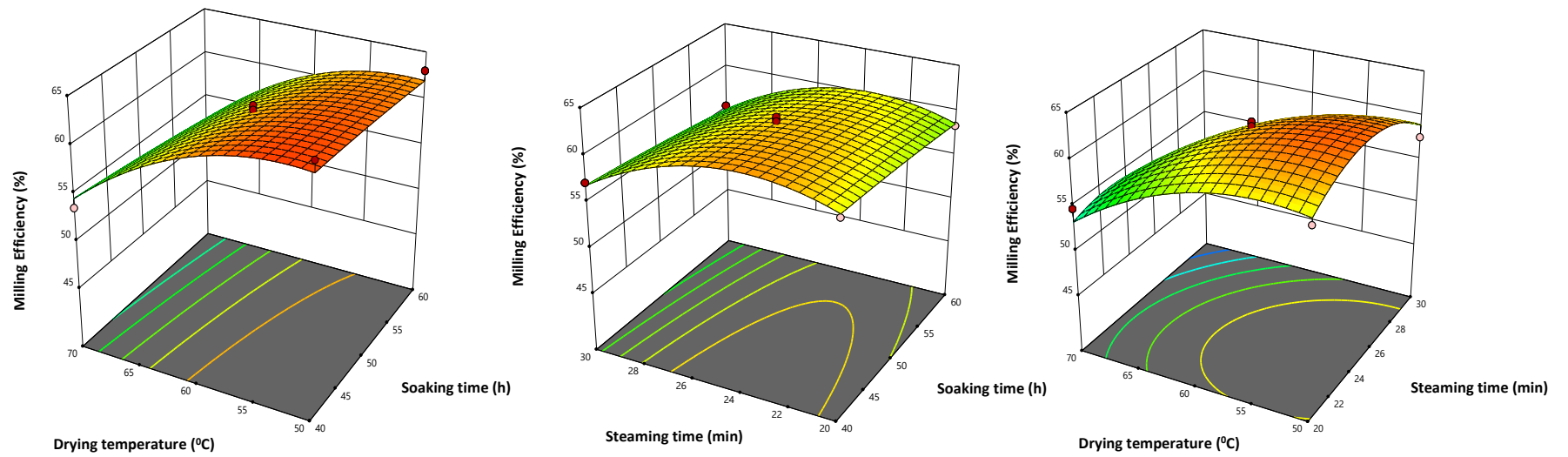

Fig. 4.2 Effect of parboiling on milling efficiency in cold soaking

Table 4.1 Milling efficiency of parboiled paddy in hot soaking and cold soaking

Sl. No	Hot soaking		Cold soaking	
	Treatments	Milling efficiency (%)	Treatments	Milling efficiency (%)
1	HT1	57.847	CT1	59.866
2	HT2	61.387	CT2	58.354
3	HT3	50.177	CT3	57.167
4	HT4	50.509	CT4	55.363
5	HT5	64.004	CT5	62.499
6	HT6	66.715	CT6	64.489
7	HT7	56.053	CT7	53.591
8	HT8	59.956	CT8	51.225
9	HT9	59.088	CT9	59.431
10	HT10	58.789	CT10	57.579
11	HT11	54.614	CT11	54.731
12	HT12	49.016	CT12	48.263
13	HT13	63.573	CT13	61.471
14	HT14	63.022	CT14	60.707
15	HT15	63.819	CT15	60.274
16	HT16	63.959	CT16	61.708
17	HT17	63.497	CT17	61.221

4.2.2 Effect of parboiling on head rice yield

The head rice yield was calculated as percentage of weight of whole grains after milling with respect to that of rough rice. Head rice is termed as the rice kernel having length three fourth or more of their original length after the completion of the milling process. Table 4.2 shows that the highest head rice yield of 88.67% was observed for

the treatment with soaking time of 7 h, steaming time of 25 min and drying air temperature 50°C in hot soaking. Soaking duration of 60 h along with 25 mins of steaming time and 50°C drying temperature yield a maximum head rice yield of 84.24% in cold soaking. The lowest values were 71.67% and 73.12% for the treatments with hot soaking time of six hours and cold soaking time of 50 hours, respectively when dried at 70°C.

The head rice yield followed the similar trend as that of milling efficiency. Increase in the steaming time and drying temperature had a significant effect on the head rice yield (Appendix A3 and B3). In both the soaking methods, it could be observed that the head rice yield increased with increasing steaming time and reached to a maximum value for a steaming time of 25 min and then fell down when the steaming time attained 30 min (Figures 4.3 and 4.4). Increase in steaming time aids in cementing the cracks inside the starch and thus the grains became harder to produce more head rice yield during milling. Taghinezhad *et al.* (2015) reported that the head rice yield increased significantly when the steaming time was increased from 4 to 6 min and while rest of the steaming time exhibited a slightly significant decrease. Increase in steaming time resulted in the severe deformation of the grain and lost the exuded party of the endosperm. So the excessive absorption of moisture led to the reduced head rice yield (Parnsakhorn and Noomhorm, 2008).

In hot soaking and cold soaking, the head rice yield decreased with increase in drying temperature same as that of the trend followed in the milling efficiency. Similar observation was reported by Insprasit and Noomhorm (2001) on drying the paddy in hot air oven with a temperature range of 45 to 60°C. Litchfield and Okos (1988) stated that increase in drying temperature increased the stress in the rice kernel leading to the reduction in the yield. Comparatively the paddy undergone hot soaking had higher head rice yield and milling efficiency compared to cold soaking method.

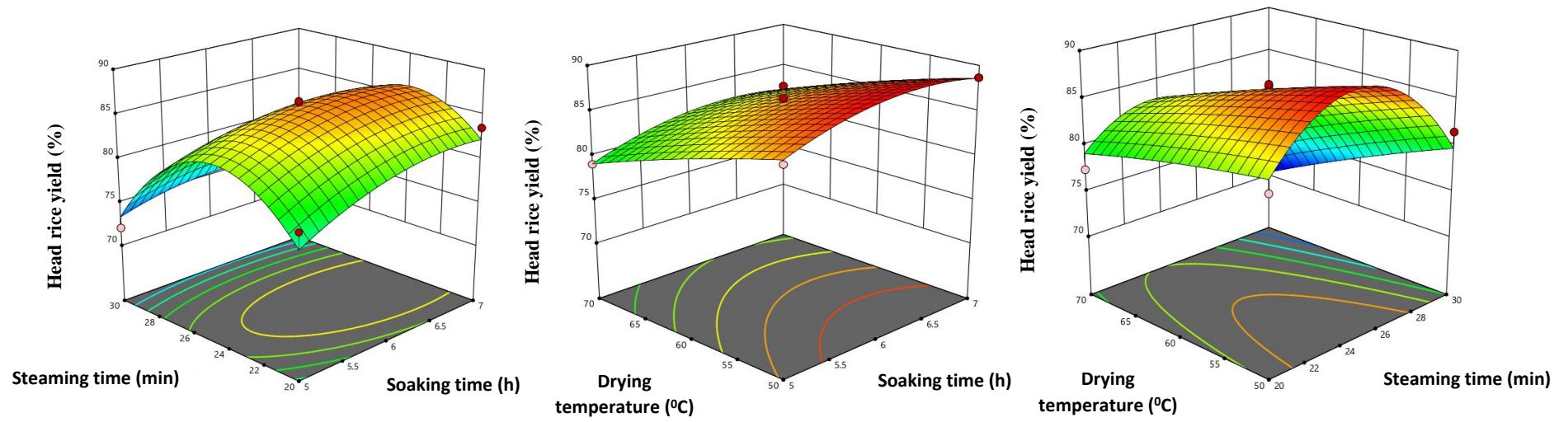

Fig. 4.3 Effect of parboiling on head rice yield in hot soaking

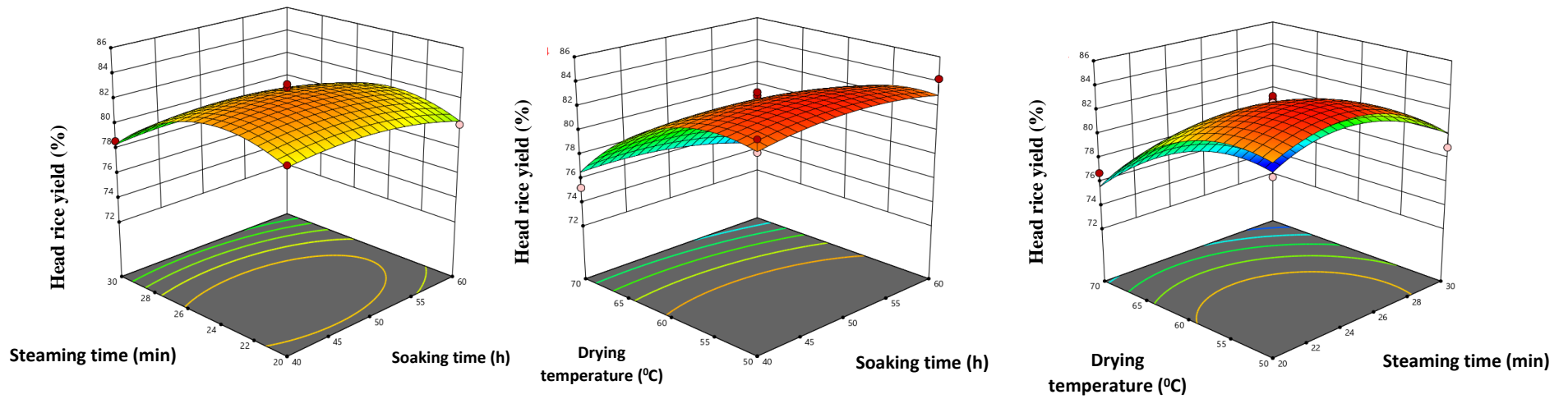

Fig. 4.4 Effect of parboiling on head rice yield in cold soaking

Table 4.2 Head rice yield of parboiled milled rice in hot soaking and cold soaking

Sl. No	Hot soaking		Cold soaking	
	Treatments	Head rice yield (%)	Treatments	Head rice yield (%)
1	HT1	79.113	CT1	81.506
2	HT2	83.546	CT2	79.992
3	HT3	72.054	CT3	78.658
4	HT4	72.113	CT4	77.267
5	HT5	85.589	CT5	83.757
6	HT6	88.677	CT6	84.241
7	HT7	79.095	CT7	75.259
8	HT8	82.496	CT8	73.638
9	HT9	81.881	CT9	81.277
10	HT10	81.465	CT10	78.936
11	HT11	77.395	CT11	76.782
12	HT12	71.675	CT12	73.126
13	HT13	85.951	CT13	82.911
14	HT14	85.333	CT14	82.466
15	HT15	86.333	CT15	81.983
16	HT16	86.511	CT16	83.183
17	HT17	85.834	CT17	82.616

4.3 Effect of parboiling on the qualities of milled rice

4.3.1 Hardness

Hardness is the one of the most important physical properties of the parboiled rice that maximizes the milling efficiency and the head rice yield. Hardness depended on the severity of the parboiling treatment. Figure 4.5 and 4.6 shows that the steaming

time and drying temperature had a significant effect on the hardness of the parboiled rice. Table 4.3 reveals that highest hardness values of 90.34 N and 103.02 N were found for the hot soaking and cold soaking treatments, steamed for 25 min and dried at 50°C. The lowest values of hardness were found in the treatments steamed with highest steaming times and drying temperatures. Similar to milling efficiency and head rice yield, the hardness of paddy increased when the steaming time was increased from 20 to 25 min, after which it reduced with further increase in steaming time.

Islam *et al.* (2001) also reported that the hardness of the parboiled rice was related to the steaming conditions. As steaming time increases, the hardness value increased to a certain limit of 25 min and decreased with further increase. Increasing steaming time to a certain extent led to the more compaction of endosperm starch in the parboiled rice kernel and improved the fracture resistance. The further increase of steaming led to the deformation of the grain and exuded endosperm due to the husk splitting and the hardness value got decreased (Taghinezhad *et al.*, 2015).

Many researchers reported that hardness of the parboiled rice was affected by the parboiling conditions, moisture content after drying, balance of starch gelatinization and retrogradation (Itoh and Kawamura, 1985; Kimura, 1991). The hard texture of the parboiled rice was due to the gelatinization of starch and adhesion between starch granules and protein bodies. The cracks and chalkiness of the rice grain got completely healed by the swelling of starch and improved the hardness (Sahay and Singh, 2001).

Like the trends of milling efficiency and head rice yield explained above, the hardness also decreased with increase in the drying temperatures (Fig. 4.5 and 4.6). It might be due to the internal stress developed inside the rice kernel with increase in the drying temperature (Litchfield and Okos, 1988). The variation in soaking time is insignificant in this study (Appendix A5 and B5).

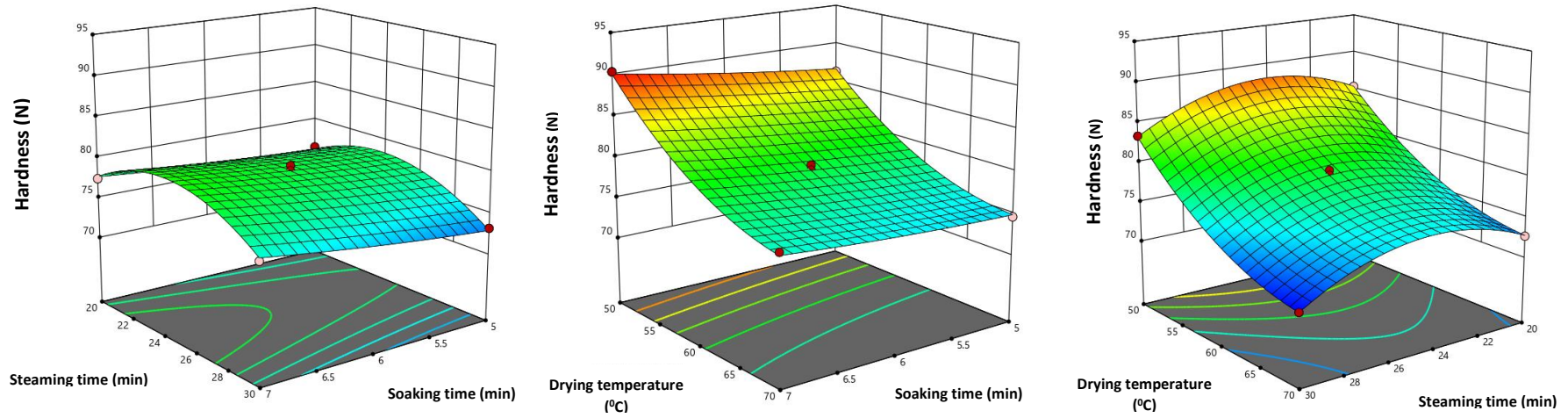

Fig. 4.5 Effect of parboiling on hardness in hot soaking

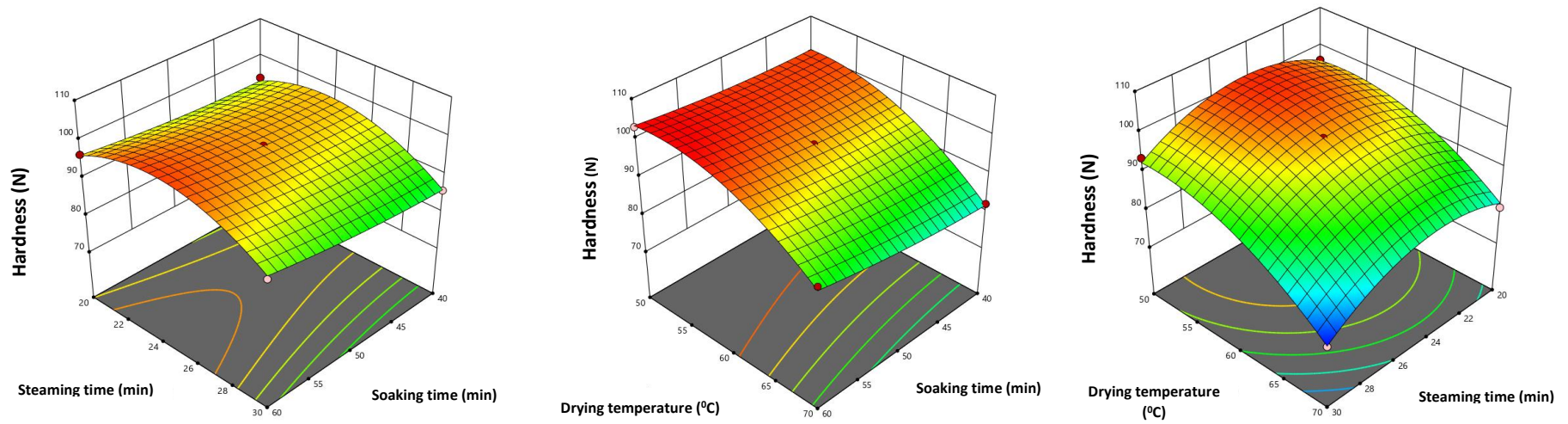

Fig. 4.6 Effect of parboiling on hardness in cold soaking

Table 4.3. Hardness of the parboiled rice in hot soaking and cold soaking

Sl. No	Hot soaking		Cold soaking	
	Treatments	Hardness (N)	Treatments	Hardness (N)
1	HT1	76.257	CT1	94.101
2	HT2	77.401	CT2	96.323
3	HT3	73.160	CT3	85.970
4	HT4	75.876	CT4	90.977
5	HT5	86.338	CT5	100.18
6	HT6	90.338	CT6	103.02
7	HT7	74.582	CT7	82.101
8	HT8	76.906	CT8	89.155
9	HT9	85.338	CT9	96.323
10	HT10	83.337	CT10	93.626
11	HT11	72.642	CT11	79.736
12	HT12	70.472	CT12	72.977
13	HT13	79.920	CT13	98.180
14	HT14	78.957	CT14	97.928
15	HT15	79.062	CT15	98.034
16	HT16	79.169	CT16	98.158
17	HT17	79.281	CT17	98.262

4.3.2 Chroma value

The colour of the parboiled milled rice is the one of the quality indicator which decides the value it has in the market. The chroma values were obtained using Hunter lab colourimeter by analyzing the L*, a* and b* values were shown in the table 4.4.

The statistical analysis of ANOVA (Appendix A6 and B6) revealed that the soaking time, steaming time and the drying temperature had significant effect on the chroma value of the parboiled milled rice. In both hot and cold soaking, highest values of chroma was observed for the treatment with soaking time (hot soaking = 7 h and cold soaking = 60 h), followed by 30 min steaming and drying at 60°C drying temperature. Lowest values were found for the treatment with 6 h (hot soaking) and 50 h (cold soaking) Soaking time, 20 min steaming time and 50°C drying temperature.

The chroma values of the milled rice for the hot and cold soaking followed a similar pattern and it ranged between 32.40 to 35.07 and 32.39 to 34.50, respectively. It is observed from the figures 4.7 and 4.8 that the chroma values increases slightly with increase in soaking and steaming durations. The bran around the kernel was dissolved during soaking and steaming and then absorbed by the endosperm resulting in change of chroma values in the parboiled rice (Bualuang *et al.*, 2013). The effect of parboiling conditions on the chroma value have also been presented by other researchers (Miah *et al.*, 2002a ; Sareepuang *et al.*, 2008). They reported that the husk pigment contributed to the chroma value by diffusing into the endosperm during parboiling. Sugar could be released during parboiling leading to the subsequent reaction of sugar with the aminoacids of the grain resulting in discolouration of milled rice. High steaming time was not preferred by Miah *et al.* (2002) that leads to poor quality of the milled rice. The figures 4.7 and 4.8 shows that the chroma value shows a positive response with increase in drying temperature.

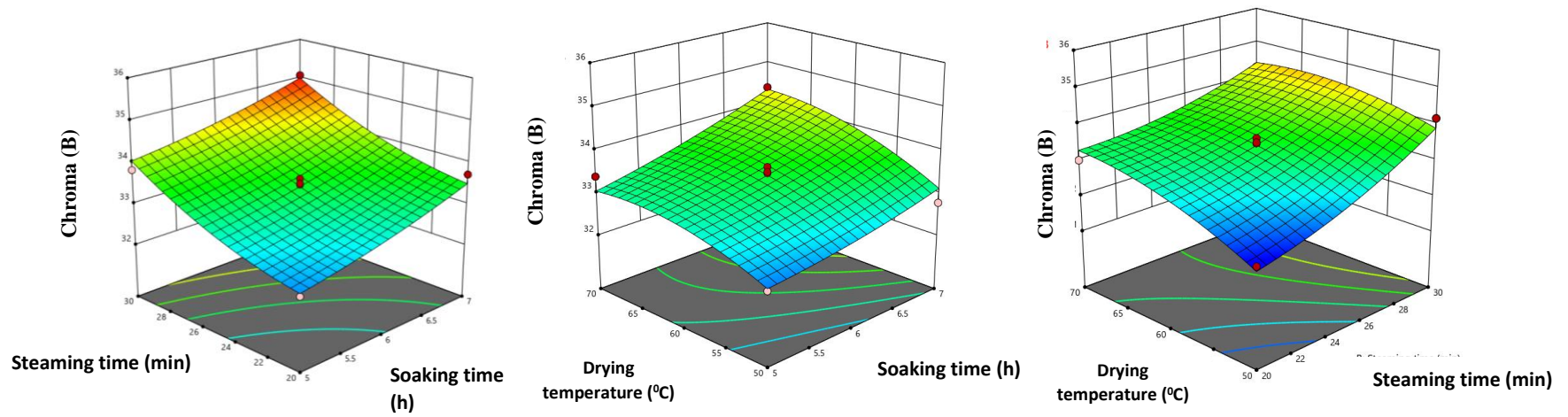

Fig. 4.7 Effect of parboiling on the Chroma value of milled rice in hot soaking

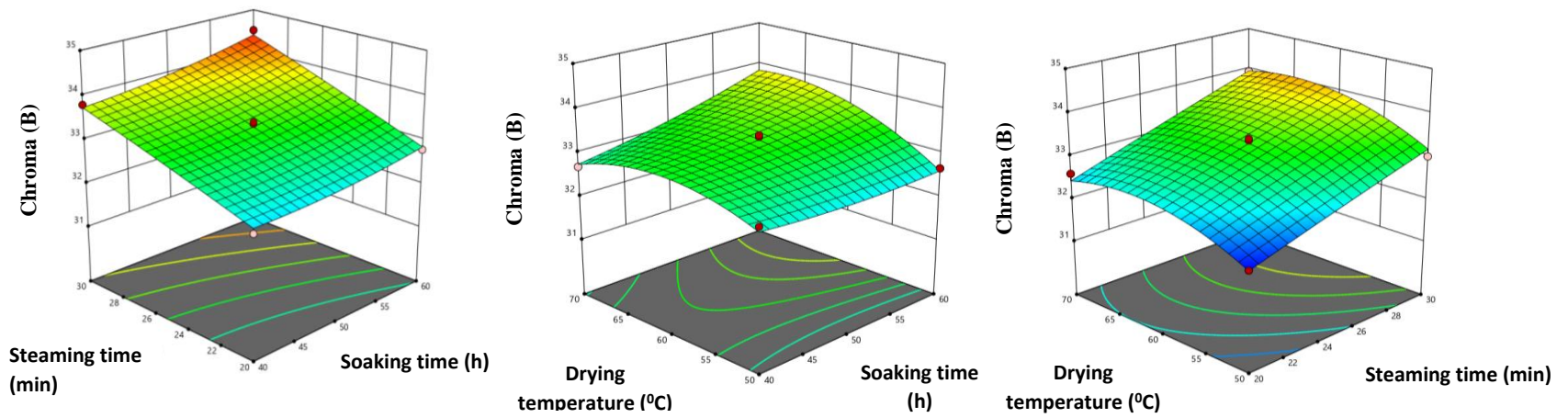

Fig. 4.8 Effect of parboiling on the Chroma value of milled rice in cold soaking

Similar results were observed by Swasdisevi *et al.* (2010) in a comparative study of quality attributes of parboiled paddy. The whiteness decreased and yellowness increased with increasing in the drying temperature. Soponronnarit *et al.* (2005) states that with increase in temperature of the drying air, the heat energy penetrates into the rice kernel and heating to a high temperature results in occurrence of more browning reactions. This was due to the higher diffusion of the red pigments from bran and hull into the endosperm during drying at elevated temperatures.

Table 4.4 Chroma value of the parboiled milled rice in hot soaking and cold soaking

Sl. No	Hot soaking		Cold soaking	
	Treatments	Chroma value	Treatments	Chroma value
1	HT1	32.402	CT1	32.397
2	HT2	33.721	CT2	32.786
3	HT3	33.827	CT3	33.801
4	HT4	35.071	CT4	34.504
5	HT5	32.354	CT5	32.809
6	HT6	32.771	CT6	32.654
7	HT7	33.392	CT7	32.691
8	HT8	34.377	CT8	33.729
9	HT9	32.043	CT9	31.925
10	HT10	34.167	CT10	33.003
11	HT11	33.007	CT11	32.598
12	HT12	34.255	CT12	33.932
13	HT13	33.133	CT13	33.256
14	HT14	33.474	CT14	33.373
15	HT15	33.622	CT15	33.281
16	HT16	33.502	CT16	33.206
17	HT17	33.402	CT17	33.411

4.3.3 Bulk density and True density

The values of bulk and true densities are slightly different in hot and cold soaking methods. Figures 4.9, 4.10, 4.11 and 4.12 depicts the three dimensional plot of effect of treatments on the true and bulk densities of the parboiled milled rice. It shows that the variation in soaking time, steaming time and drying temperature did not significantly impact in bulk density in both soaking methods. This finding is in agreement with Hapsari *et al.* (2016) who reported that parboiling had no significant effect on bulk density of rice. Further, the values were influenced by the roundness of kernel. The more round the kernel, the greater bulk density. Saeed *et al.* (2011) also reported that bulk density of milled rice depended on the degree of milling and fineness characteristics of the grain.

Similar patterns to bulk density was observed for the true density of the milled rice. The parboiling did not exert any significant effect on the true density in both soaking methods ($p \text{ value} > 0.05$) (Appendix A7, A8, B7 and B8). This finding is par with Bhattacharya (2013). He reported that true density of the milled rice depends on the degree of milling and it could be due to the loss of lighter fat in the milling process. Husk aided to keep the kernel intact maintaining the uniformity of structure (Wahengbam and Hazarika, 2019). This might be the reason for the slight changes of bulk density and true density of the parboiled rice under the variation of the independent parameters.

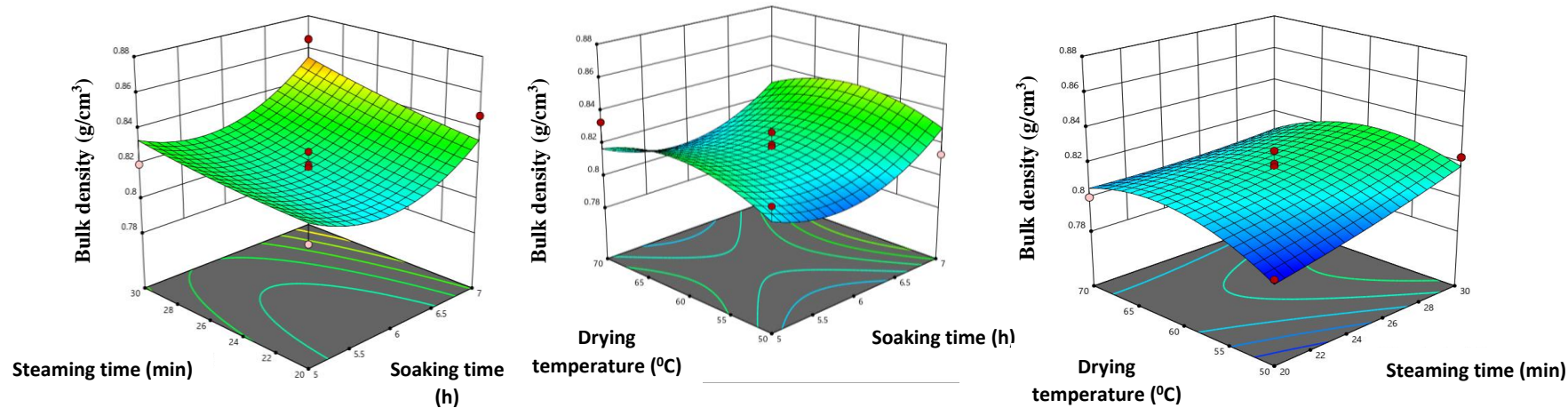

Fig. 4.9 Effect of parboiling on the bulk density of milled rice in hot soaking

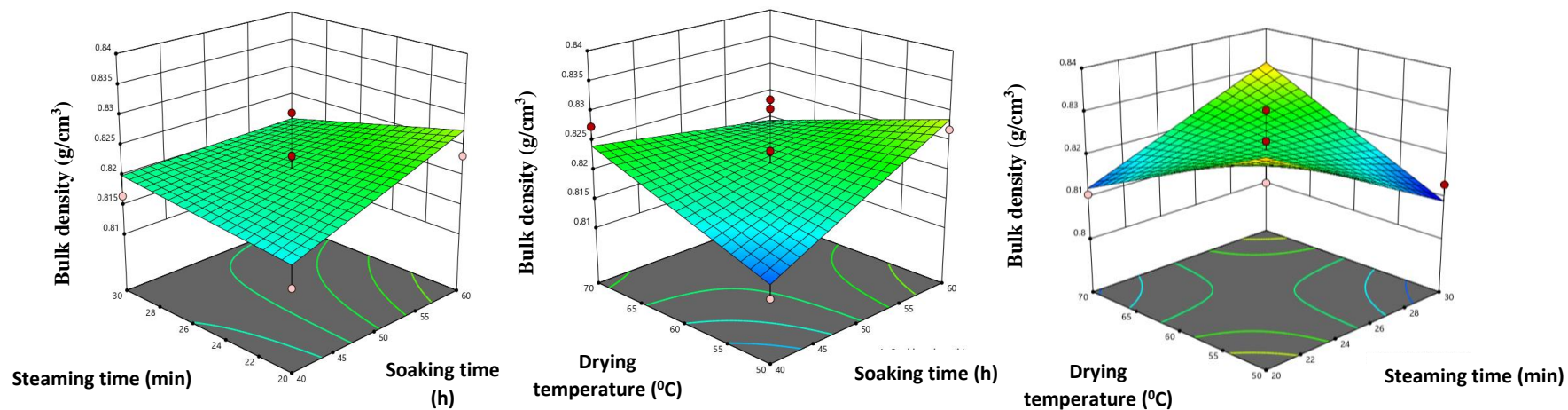

Fig. 4.10 Effect of parboiling on the bulk density of milled rice in cold soaking

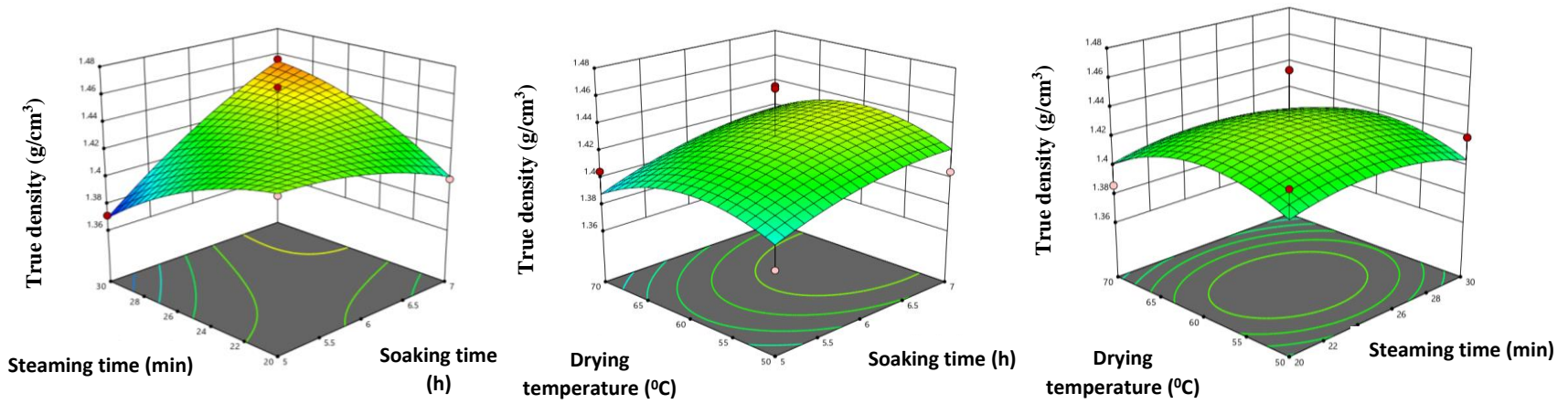

Fig 4.11 Effect of parboiling on the true density of milled rice in hot soaking

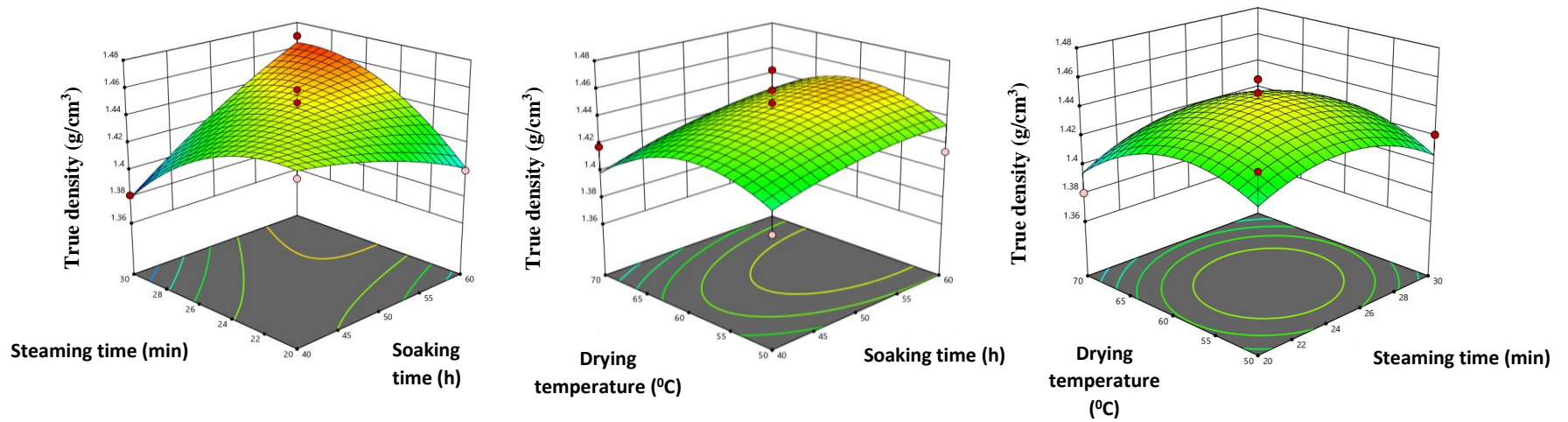

Fig. 4.12 Effect of parboiling on the true density of milled rice in cold soaking

Table 4.5 Bulk density and true density of the parboiled milled rice in hot soaking and cold soaking

Sl. No	Hot soaking			Cold soaking		
	Treatments	Bulk density (g/cm ³)	True density (g/cm ³)	Treatments	Bulk density (g/cm ³)	True density (g/cm ³)
1	HT1	0.813	1.429	CT1	0.816	1.435
2	HT2	0.847	1.398	CT2	0.810	1.400
3	HT3	0.819	1.371	CT3	0.823	1.381
4	HT4	0.865	1.456	CT4	0.823	1.469
5	HT5	0.819	1.380	CT5	0.827	1.399
6	HT6	0.813	1.404	CT6	0.813	1.414
7	HT7	0.833	1.405	CT7	0.829	1.418
8	HT8	0.820	1.435	CT8	0.830	1.442
9	HT9	0.793	1.427	CT9	0.823	1.437
10	HT10	0.823	1.420	CT10	0.810	1.421
11	HT11	0.801	1.386	CT11	0.836	1.380
12	HT12	0.806	1.379	CT12	0.823	1.382
13	HT13	0.827	1.465	CT13	0.816	1.459
14	HT14	0.819	1.420	CT14	0.827	1.449
15	HT15	0.817	1.423	CT15	0.823	1.433
16	HT16	0.813	1.424	CT16	0.813	1.444
17	HT17	0.809	1.422	CT17	0.813	1.442

4.3.5 Chalkiness

Chalky rice is defined as the rice kernel having a white opaque center in its endosperm. It is related to the grain translucency which is an important index for rice

quality. The degree of chalkiness of the parboiled rice in both the soaking methods are tabulated in the table 4.5. Parboiling had significant effect on chalkiness of rice kernels. Chalkiness decreased with parboiling for all the treatments. The table shows that all the treatments reistered scale ‘one’. ie., the chalkiness values were less than 10%. Zohoun *et al.* (2017) reported that chalkiness decreased by at least 92 % for the steaming duration of 5 minutes and reduced to 100% with increase of the steaming duration to 15 min in confirmation with earlier studies done by Manful *et al.* (2008) and Ndindeng *et al.* (2015).

Translucency character which is inversely proportional to the amount of chalkiness got enhanced by increased soaking and steaming duration. This character of the endosperm determined the appearance of the grain and its acceptable quality (Meresa *et al.* 2020). Kondo (2006) stated that, due to the pre-gelatinization of the rice starch, the translucency characteristics of the endosperm increased by parboiling process. Lin *et al.* (2016) pointed out that the incomplete gelatinization of rice starch leads to the appearance of white spot within the rice grain such as translucent exterior layer and dim center. This resulted in the formation of few white core grains in the parboiled rice. The incomplete gelatinization of rice granule could be due to a moisture gradient within the grains during parboiling (Srisang and Chungchaoren, 2019).

Table 4.6 Chalkiness values of the parboiled milled rice in hot soaking and cold soaking

Sl. No.	Hot soaking		Cold soaking	
	Treatments	Chalkiness	Treatments	Chalkiness
1	HT1	3	CT1	5
2	HT2	9	CT2	3
3	HT3	8	CT3	7
4	HT4	4	CT4	8
5	HT5	8	CT5	9

6	HT6	7	CT6	7
7	HT7	9	CT7	5
8	HT8	2	CT8	6
9	HT9	6	CT9	6
10	HT10	5	CT10	4
11	HT11	9	CT11	2
12	HT12	4	CT12	6
13	HT13	8	CT13	4
14	HT14	7	CT14	3
15	HT15	6	CT15	4
16	HT16	8	CT16	2
17	HT17	5	CT17	3

4.4 Effect of parboiling on the cooking qualities of parboiled milled rice

4.4.1 Cooking time

Cooking time is the time required for the cooking of the rice sample until 90% of it had no white core while pressing it between two petridishes. The time required for the cooking of rice in hot soaking and cold soaking are tabulated in the given table 4.6. Cooking time of rice samples from the hot soaking and cold soaking ranged between 20:51 min to 24:52 min and 19:41 min to 25:45 min respectively. For hot soaking, maximum cooking time of 20:51 min was recorded for rice soaked for 6 h, followed by 30 min steaming and drying at 70°C temperature. Maximum cooking time of 25:45 min in cold soaking was observed in the treatment where the sample was soaked for 50 h, steamed to 30 min and dried at 50°C.

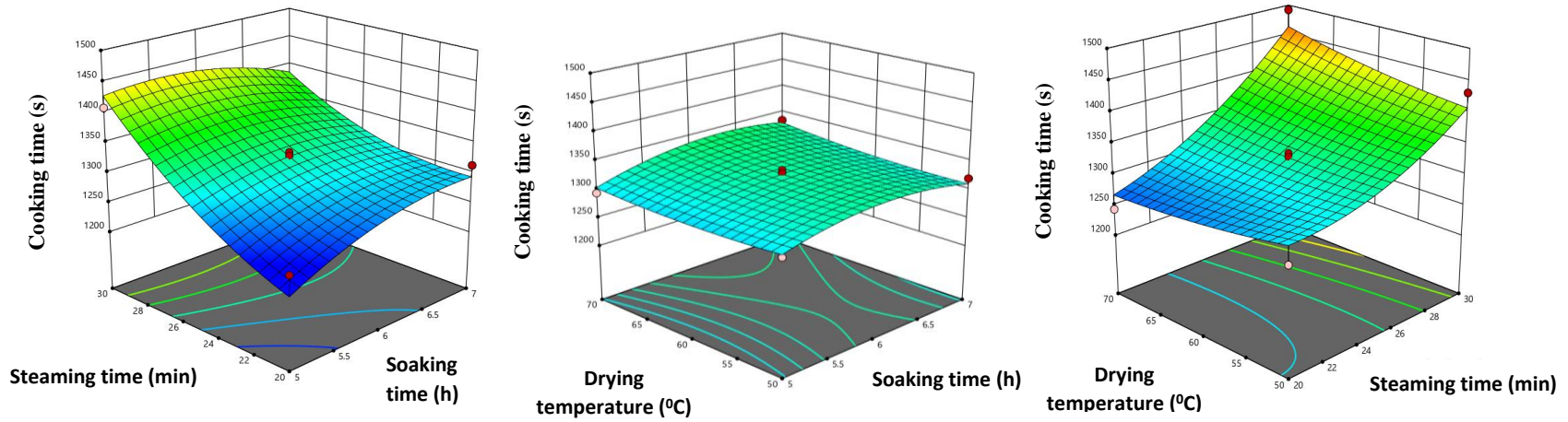

Fig. 4.13 Effect of parboiling on the cooking time of milled rice in hot soaking

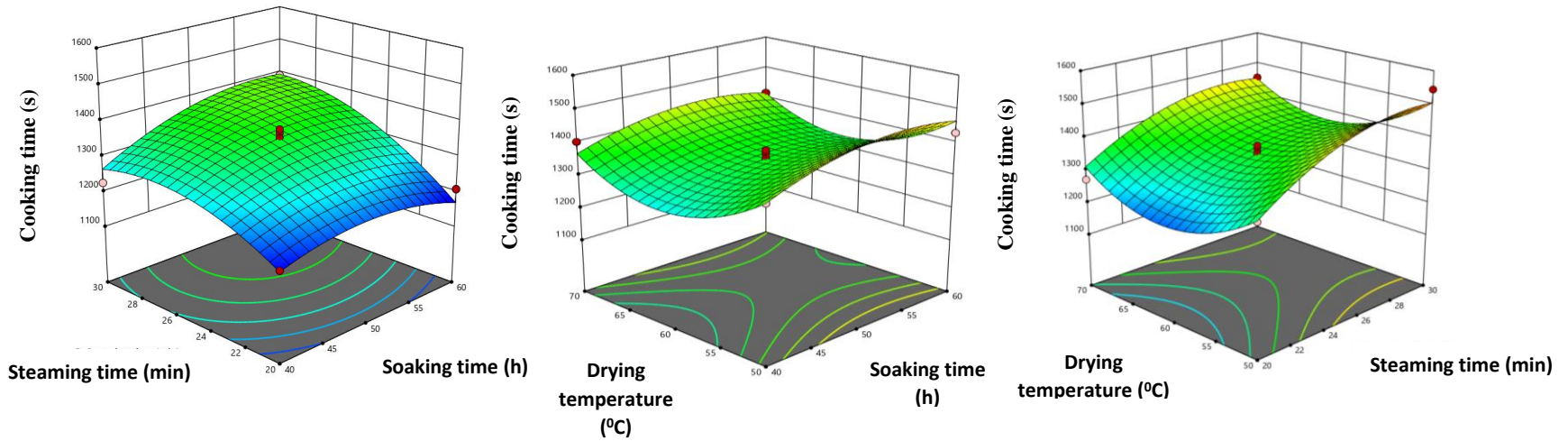

Fig. 4.14 Effect of parboiling on the cooking time of milled rice in cold soaking

As represented in the Figures 4.13 and 4.14, it is clear that in both soaking methods, only steaming time influenced the cooking time of the parboiled milled rice. Cooking time increased gradually with increase in steaming time. The effect of soaking time and drying temperature was not statistically significant on the cooking time of parboiled rice. ANOVA table shows that p value < 0.05 for steaming time (Appendixes A10 and B10)). Similar findings were reported by Manful *et al.* (2008). They found that the cooking time increased from 21 to 23 min as the duration of steaming increases. Meresa *et al.* (2020) reported a trend of increase in the cooking time when the soaking temperature and steaming time were increased. However, the results obtained for cooking time were in the range reported by Tetens *et al.* (1997) (20.70 – 23.05 min) and by Saeed *et al.* (2011) (25.00 min) for parboiled rice samples. Otegbayo *et al.* (2001) reported that parboiled rice samples had longer cooking time compared to raw rice due to the strong cohesion between the endosperm cells that made the tightly packed starch granules to hydrate at a slower rate, which resulted in decreased water penetration into the grain. Ayamdoo *et al.* (2014) emphasised that, aside parboiling, cooking time depended on several factors like rice variety, intensity of heat supply, moisture content and grain hardness.

Table 4.7 Cooking time of parboiled cooked rice in hot soaking and cold soaking methods

Sl. No	Hot soaking		Cold soaking	
	Treatments	Cooking time (min)	Treatments	Cooking time (min)
1	HT1	20:51	CT1	19:41
2	HT2	21:53	CT2	20:08
3	HT3	23:28	CT3	20:26
4	HT4	22:33	CT4	23:12
5	HT5	21:38	CT5	23:13
6	HT6	22:00	CT6	23:50

7	HT7	21:34	CT7	23:23
8	HT8	22:15	CT8	23:37
9	HT9	21:13	CT9	22:08
10	HT10	23:51	CT10	25:45
11	HT11	20:43	CT11	22:52
12	HT12	24:52	CT12	24:13
13	HT13	22:04	CT13	22:47
14	HT14	22:15	CT14	22:33
15	HT15	22:07	CT15	22:58
16	HT16	22:09	CT16	21:55
17	HT17	22:03	CT17	22:32

4.4.2 Water uptake ratio

The water up take ratio also follows the same trend as that of cooking time (Fig. 4.15 and 4.16). The water uptake ratio increased with increase in steaming time. The values was within the range between 1.6398 - 2.4349 and 1.6585 - 2.6190 for hot soaking and cold soaking methods respectively. Highest values of water uptake ratio for both the methods were observed for the treatments subjected to 30 minutes steaming. During steaming, pores could be clogged by movement of molecules and oil in and out of the embryo contained in the grain. Thus more time would be needed for the water to penetrate these tightly packed molecules resulting in more cooking time as well as more water uptake ratio (Chavan *et al.*, 2018).

The present findings is similar to the resulted reported by Meresa *et al.* (2020), who reported water uptake values between 1.85 to 3.1 and found that parboiling drastically increases the water uptake ratio of the rice. Meresa *et al.* (2020) reported that high water absorption capacity enabled the parboiled rice to absorb more water without losing its shape and integrity. Mustapha (1979) also supported higher water

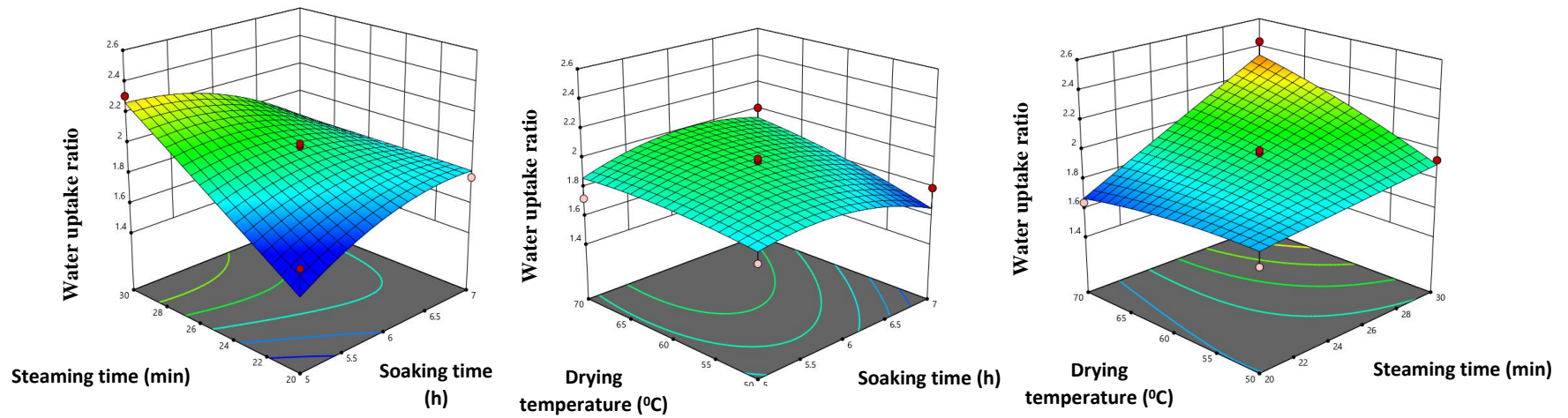

Fig. 4.15 Effect of parboiling on the water uptake ratio of cooked rice in hot soaking

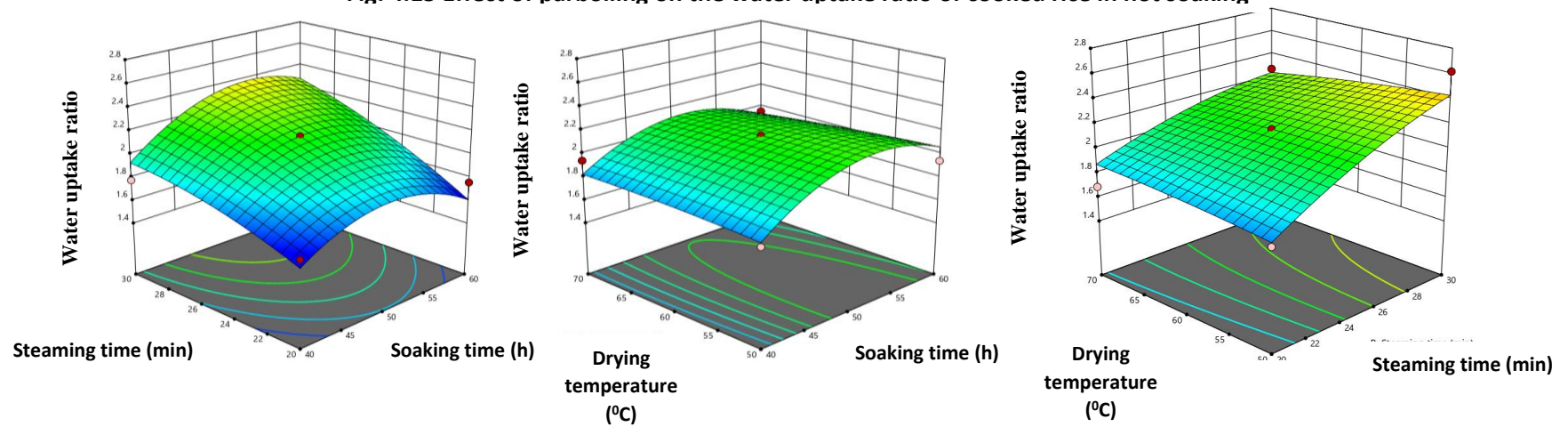

Fig. 4.16 Effect of parboiling on the water uptake ratio of cooked rice in cold soaking

absorption for parboiled rice, which might be due to the starch gelatinization caused by long steaming. The variation in soaking time and drying temperature was not significant in the study (Appendixes A11 and B12).

Table 4.8 Water uptake ratio of parboiled milled rice

Sl. No	Hot soaking		Cold soaking	
	Treatments	Water uptake ratio	Treatments	Water uptake ratio
1	HT1	1.651	CT1	1.658
2	HT2	1.776	CT2	1.760
3	HT3	2.309	CT3	1.779
4	HT4	1.655	CT4	2.207
5	HT5	1.746	CT5	1.757
6	HT6	1.796	CT6	1.944
7	HT7	1.722	CT7	1.945
8	HT8	2.008	CT8	1.955
9	HT9	1.680	CT9	1.754
10	HT10	1.932	CT10	2.619
11	HT11	1.639	CT11	1.686
12	HT12	2.435	CT12	2.269
13	HT13	1.858	CT13	2.161
14	HT14	1.953	CT14	2.161
15	HT15	1.982	CT15	2.160
16	HT16	1.996	CT16	2.161
17	HT17	2.001	CT17	2.160

4.3.3 Gruel solid loss

Amount of solids leached from the kernel to the surrounding water during cooking is termed as gruel solid loss. Leached solids mainly consist of starch, lipids, proteins and other minor components. It is revealed from the table 4.8 that, the highest gruel solid loss of 0.0558 g in hot soaking was observed for the treatment with 6 h of soaking, 20 min of steaming time and 50°C drying temperature. The highest value of 0.0710 g was observed for the treatment with 50 h of soaking, 20 min of steaming time and 60°C drying temperature for cold soaked samples. The lowest value of gruel solid loss (0.0446 g) was observed for the treatment subjected to 6 h of soaking, 30 min of steaming time and drying at 70°C in hot soaking. For cold soaking, lowest value (0.0248 g) was found for 50 h of soaking, 30 min of steaming time and drying temperature of 50°C.

ANOVA for the gruel solid loss (Appendix A12 and B12) shows that the duration of steaming has significant effect on the solid gruel loss. The solid gruel loss decreased as the steaming time increased. The range of solid gruel loss was within 0.04469 - 0.05581 g/g and within 0.02481- 0.07105 g/g for hot soaking and cold soaking methods respectively. From the Figures 4.17 and 4.18, it is evident that the gruel solid loss decreases with duration of steaming time. Chavan *et al.* (2018) reported a decrease in the amount of solid dissolution into the cooking water during parboiling. Soponronnarit *et al.* (2005) reported that decrease in the gruel solid loss with steaming was due to the stronger structure of the rice imparted by gelatinization of starch. Researchers such as Kurien *et al.* (1964) and Kimura (1983) also reported that parboiling resulted in a compact arrangement of starch in the kernel and greater cohesion between the starch granules and protein bodies owing to the reduced solid loss in gruel. Also, pore spaces in the grains were found to reduce on gelatinization of starch in the process of parboiling. Thus, during cooking, the hard outer surface imparted resistance to leaching during cooking (Agrawal *et al.*, 2015). The variation in the soaking time and drying temperature is insignificant for the gruel solid loss.

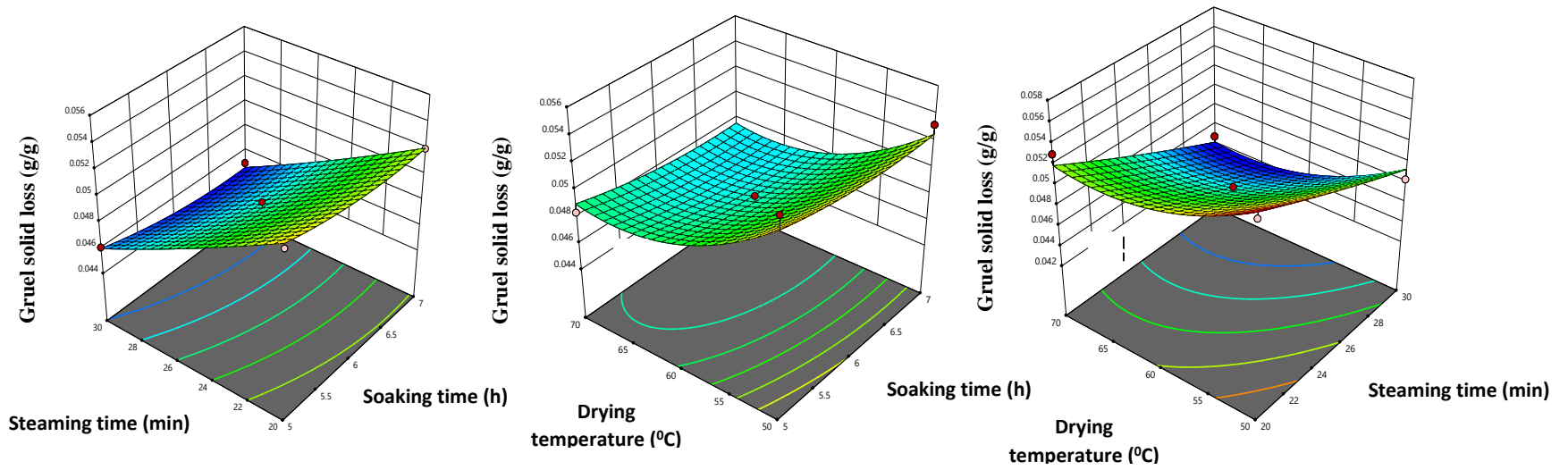

Fig. 4.17 Effect of parboiling on gruel solid loss in hot soaking

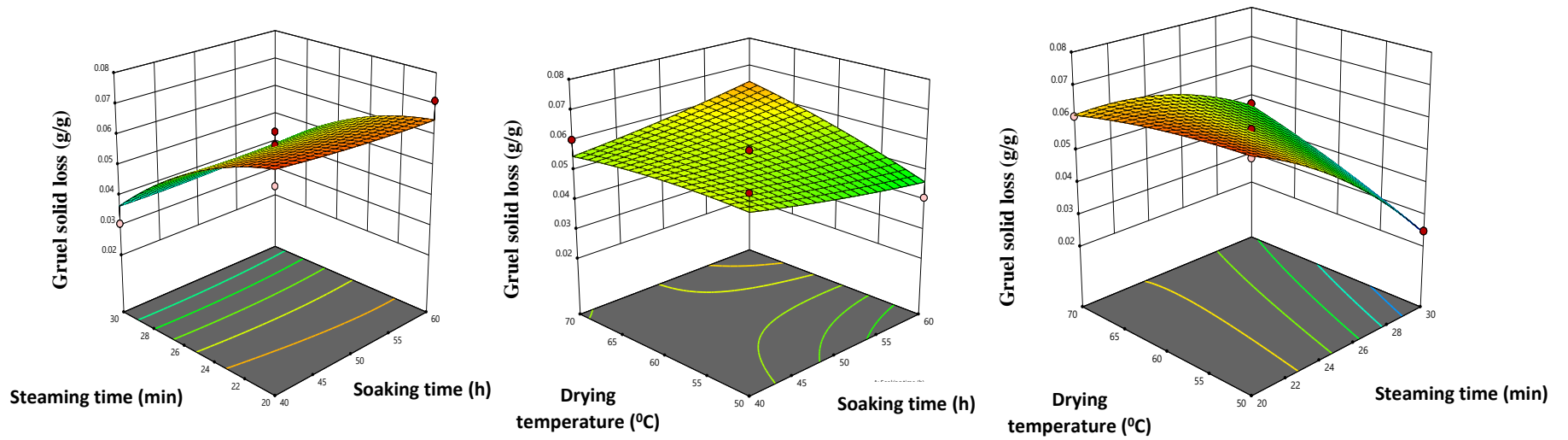

Fig. 4.18 Effect of parboiling on gruel solid loss in cold soaking

Table 4.9 Gruel solid loss of cooked rice in hot soaking and cold soaking

Sl. No	Hot soaking		Cold soaking	
	Treatments	Gruel solid loss (g/g)	Treatments	Gruel solid loss (g/g)
1	HT1	0.0529	CT1	0.0633
2	HT2	0.0520	CT2	0.0710
3	HT3	0.0460	CT3	0.0306
4	HT4	0.0448	CT4	0.0435
5	HT5	0.0548	CT5	0.0627
6	HT6	0.0532	CT6	0.0409
7	HT7	0.0483	CT7	0.0603
8	HT8	0.0466	CT8	0.0587
9	HT9	0.0558	CT9	0.0673
10	HT10	0.0483	CT10	0.0248
11	HT11	0.0530	CT11	0.0606
12	HT12	0.0446	CT12	0.0474
13	HT13	0.0487	CT13	0.0569
14	HT14	0.0480	CT14	0.0558
15	HT15	0.0479	CT15	0.0565
16	HT16	0.0482	CT16	0.0568
17	HT17	0.0484	CT17	0.0559

4.3.4 Grain elongation ratio

Grain elongation for the hot soaking and cold soaking methods during parboiling process is enumerated in Table 4.10. Steaming exerted significant effect on the grain elongation ratio of the parboiled rice in both hot and cold soaking methods.

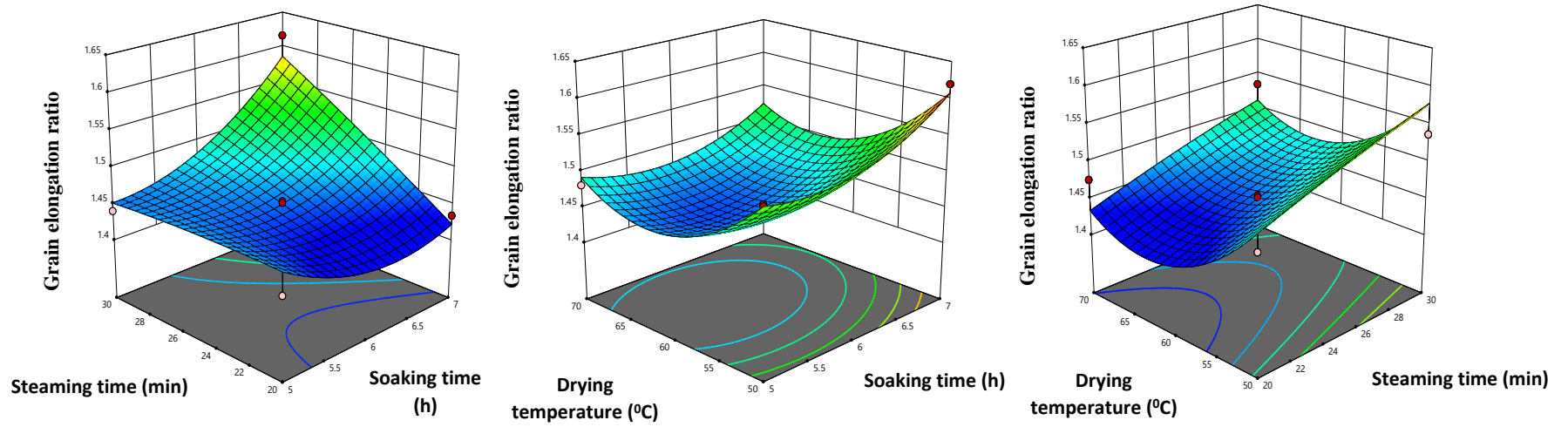

Fig. 4.19 Effect of parboiling on grain elongation ratio in hot soaking

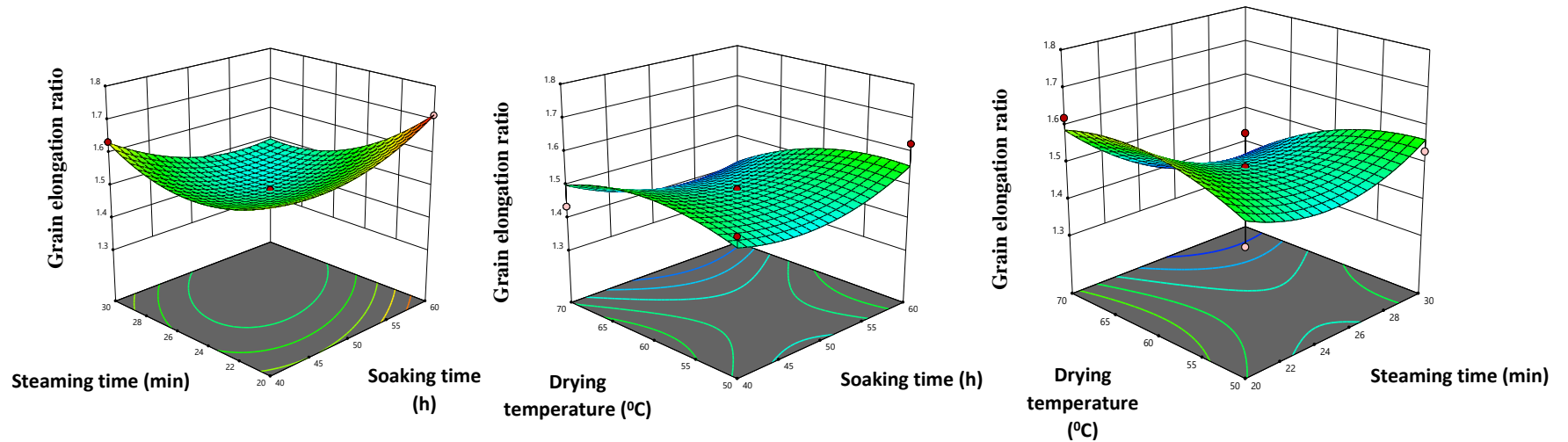

Fig. 4.20 Effect of parboiling on grain elongation ratio in cold soaking

Figures 4.19 and 4.20 indicated that the grain elongation ratio increases with duration of steaming. The value ranges within 1.4275 - 1.6196 and 1.4661 - 1.7131 in hot soaking and cold soaking methods respectively. These findings were similar to Meresa *et al.* (2020) who reported that parboiling increased the grain elongation ratio drastically within a range of 2.44 to 2.76 when steaming the rice from 10 to 50 min. Similar findings had reported by Khatoun and Prakash (2007) who got values within 1.80 to 1.94.

On comparing the parboiled rice and raw rice, parboiled rice had lower grain elongation than raw rice cooked for the same period. However, comparing the samples cooked to an equivalent degree of softness, parboiled rice could absorb more water without losing its shape and integrity (Kurien *et al.*, 1964). It is evident that the duration of steaming significantly affected the grain elongation ratio, the time being dependent on hot and cold soaking methods (Appendixes A13 and B13).

Table 4.10. Grain elongation ratio of the cooked rice in hot soaking and cold soaking

Sl. No	Hot soaking		Cold soaking	
	Treatments	Grain elongation ratio	Treatments	Grain elongation ratio
1	HT1	1.4275	CT1	1.6435
2	HT2	1.4336	CT2	1.7138
3	HT3	1.4401	CT3	1.6341
4	HT4	1.6161	CT4	1.4638
5	HT5	1.5951	CT5	1.5317
6	HT6	1.6196	CT6	1.6249
7	HT7	1.4811	CT7	1.4355
8	HT8	1.4702	CT8	1.3855
9	HT9	1.4755	CT9	1.4661

10	HT10	1.5367	CT10	1.5316
11	HT11	1.4752	CT11	1.6213
12	HT12	1.5341	CT12	1.4254
13	HT13	1.4538	CT13	1.4896
14	HT14	1.4471	CT14	1.4886
15	HT15	1.4496	CT15	1.4891
16	HT16	1.4512	CT16	1.4889
17	HT17	1.4489	CT17	1.4885

4.3.5 Hardness of cooked rice

Hardness is one of the important textural attribute for describing the eating quality and palatability of cooked rice. ANOVA for the hardness of cooked rice (Appendix A14 and B14) indicated that parboiling exerted significant effect on the hardness of parboiled rice in both hot soaking and cold soaking. The maximum value of hardness in cold soaking and hot soaking were observed for the treatment subjected to soaking for 6 h (hot soaking) and 50h (cold soaking), followed by 30 min steaming and drying at 70°C temperature. Lower values were found for samples soaked for 6h in hot soaking method and 50 h for cold soaking method at 20 min steaming and drying at 50°C.

Figures 4.21 and 4.22 shows that hardness of the cooked rice increases as the parboiling process proceeded. This agrees with the findings of Ramesh *et al.* (1999) and Pillaiyar (1990) who reported similar increase in the hardness of cooked rice as the severity of heat treatment in the parboiling increased. Bhattacharya and Ali (1985) and Ramesh *et al.* (1999) found that reassociation of gelatinized starch that occurs during parboiling played an important role in the hardening. Also, the thermal degradation of starch that occurs during heat treatment could be an additional contributor to the

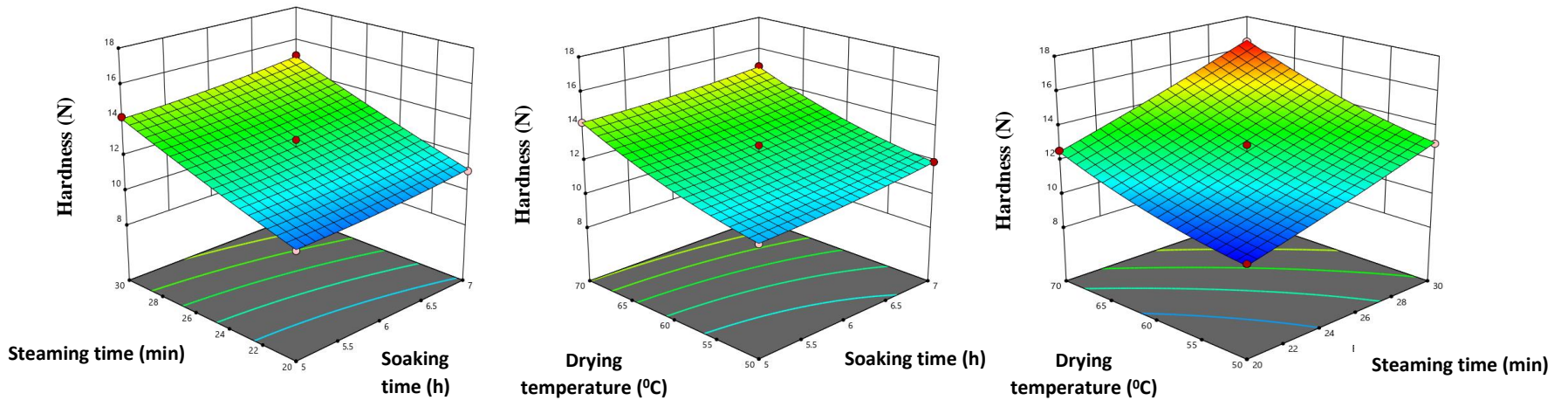

Fig. 4.21 Effect of parboiling on the hardness of cooked rice in hot soaking

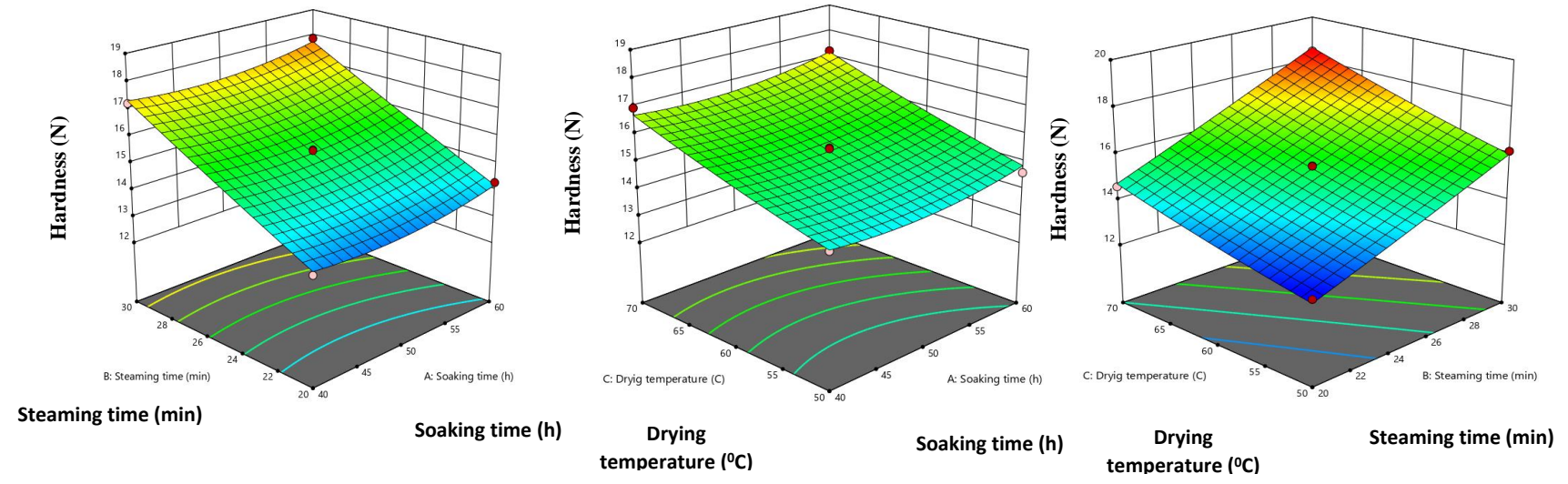

Fig.4.22 Effect of parboiling on the hardness of cooked rice in cold soaking

changes in the texture of the grain. As discussed earlier, the parboiling results in greater cohesion between starch granules and protein bodies, leading to a more compact arrangement of starch in the kernel resulted in the more hardness of cooked rice. The parboiled rice possess strong structure as the cooking proceeded (Hapsari *et al.*, 2016). Likewise, increased starch gelatinization during parboiling resulted in increase in the cohesion of rice making it less susceptible to the lump formation and subsequent reduction in adhesiveness of the cooked rice (Chavan *et al.*, 2018).

Table 4.11 Hardness of the cooked rice in cold soaking and hot soaking

Sl. No	Hot soaking		Cold soaking	
	Treatments	Hardness (N)	Treatments	Hardness (N)
1	HT1	10.57	CT1	13.62
2	HT2	11.15	CT2	14.29
3	HT3	14.21	CT3	17.21
4	HT4	15.06	CT4	17.86
5	HT5	11.01	CT5	14.44
6	HT6	11.95	CT6	14.61
7	HT7	14.25	CT7	16.95
8	HT8	14.91	CT8	17.21
9	HT9	9.95	CT9	12.95
10	HT10	13.01	CT10	16.14
11	HT11	12.59	CT11	14.59
12	HT12	16.43	CT12	18.43
13	HT13	12.93	CT13	15.23
14	HT14	12.52	CT14	15.52
15	HT15	12.49	CT15	15.49
16	HT16	12.23	CT16	15.23
17	HT17	12.48	CT17	15.48

4.4 OPTIMISATION OF PARBOILING PROCESS VARIABLES

The optimal process condition of small-scale paddy parboiling namely, soaking time for hot soaking (5, 6, and 7 h) and cold soaking (40, 50, 60 h), steaming time (20, 25 and 30 min) and drying temperature (50, 60 and 70°C) were performed using the Box-Behnken design in Design Expert Software 12.0. In the present investigation, the independent variables were kept within the range and dependent variables were chosen as maximum and minimum. Appendix C1 and C2 show response optimization constraints for parboiling of paddy in hot soaking and cold soaking respectively. The analysis showed that steaming operation significantly influenced the milling and cooking quality parameters of paddy, like HRY, hardness of parboiled paddy, Chroma value, cooking time, gruel solid loss and hardness of cooked rice. Higher the drying temperatures, lower were the attributes such as HRY and hardness. Likewise, higher the soaking and steaming durations and drying temperatures, higher values of Chroma was obtained, which is not desired.

The parboiling process parameters such as soaking time, steaming time and drying temperature were analyzed for the optimal combination in the RSM using Box-Bhenken design. The criteria considered for the parameters that offered the maximum HRY and hardness of milled rice and cooked rice and the minimum Chroma value, gruel solid loss and cooking time. The experimental results had the optimum process conditions with a soaking time of 6.67 h, steaming time of 26.07 min and drying temperature of 51.48°C for hot soaking. For cold soaking, the optimum process conditions are 60 h of steaming time followed by 27.2 min of steaming time and drying at 52.2°C. Table 4.11 shows the optimized values of independent parameters.

Table 4.12 Optimized values of independent parameters

	Hot soaking	Cold soaking
Soaking time	6.67 h	60 h
Steaming time	26.07 min	27.24 min
Drying temperature	51.48°C	52.2°C

4.5 EVALUATION OF QUALITIES OF PARBOILED PADDY WITH OPTIMUM PROCESS PARAMETERS

The paddy was parboiled in the developed small scale parboiling cum drying unit using the recommended optimum conditions of the process variables. Soaking and steaming of paddy was done in the cylindrical chamber followed by drying in the LSU dryer using the optimized temperature ($52 \pm 2^{\circ}\text{C}$) in both hot soaking and cold soaking. Comparatively, better milling efficiency and head rice yield was obtained in both hot soaking and cold soaking methods on using the optimum conditions of process variables. Thus the independent parameters for the developed unit was standardized as soaking time of 7 h, steaming time of 26 min, and drying temperature of 52°C for hot soaking. For cold soaking, the standardized parameters were, soaking time of 60h, steaming time of 27 min and drying temperature of 50°C . The responses of optimized treatments of hot soaking and cold soaking are presented in the table 4.12.

Table 4.13 Milling and cooking qualities of parboiled paddy after drying in the LSU dryer using the optimized process conditions

Sl. No.	Hot soaking		Cold soaking	
	1.	Head rice yield	87.78%	Head rice yield
2.	Milling Efficiency	65.43%	Milling Efficiency	62.15%
3.	Hardness	87.37 N	Hardness	101.39 N
4.	True density	1.4295 g/cm ³	True density	1.441 g/cm ³
5.	Bulk density	0.8241 g/cm ³	Bulk density	0.8223 g/cm ³
6.	Chroma value (B)	33.33	Chroma value (B)	32.9132
7.	Chalkiness	<10%	Chalkiness	< 10%
8.	Cooking time	1329 s	Cooking time	1509 s
9.	Water uptake ratio	1.7545	Water uptake ratio	2.2309
10.	Grain elongation ratio	1.572	Grain elongation ratio	1.5537
11.	Gruel solid loss	0.0508 g	Gruel solid loss	0.03612 g
12.	Hardness of cooked rice	12.218 N	Hardness of cooked rice	15.597 N
13.	Time taken for parboiling	Soaking = 7h Steaming=25 min Drying = 3.5 h	Time taken for parboiling	Soaking = 60 h Steaming=25 min Drying = 3.5 h

4.5. COST ECONOMICS FOR DEVELOPED PARBOILER CUM DRYING UNIT

The cost economics for the developed parboiling cum drying unit was calculated by taking the cost of one unit electricity as Rs.7/kWh. The energy cost per hour in the parboiling cum drying unit was amounted to Rs. 7/- and considering all the material and fabrication costs, the machine cost for the developed unit was Rs. 95,000/-. The parboiled paddy was produced by considering all the aspects of

fixed and variable cost involved in the investigation. The processing cost of parboiling and milling of one kilogram paddy was Rs. 2.5/- and Rs. 2.0/- respectively. The benefit cost ratio of the the parboiled paddy using the developed unit was 1.33 and it was found to be economically feasible. It could be recommended for small scale SHG/ Kudumbasree units and farmer groups. The detailed calculation is presented in Appendix D.

SUMMARY AND CONCLUSION

CHAPTER V

SUMMARY AND CONCLUSION

Rice is one of the major staple food grain around the globe. India ranks second position in rice consumption (102 million tonnes) during the period 2019-2020 (Statista, 2020). About 20% of the paddy produced in the world undergoes parboiling process. Parboiling is an optional unit operation in paddy processing, which results in improved milling efficiency with enhanced nutritional quality of the rice. It helps to concentrate nutraceuticals, improves the palatability and extends shelf life.

Parboiling is essentially a hydrothermal treatment, accomplished through the process of soaking, steaming and drying, to gelatinize the starch. While soaking increases the moisture content of the rice, steaming assists in the gelatinisation of starch and drying reduces the moisture content of the paddy in harmony with the requirements of the milling process. Parboiling yields advantages such as easier shelling, higher head rice yield, lesser broken grains, increased resistance to insects, firmer cooked rice texture, lesser gruel solid loss and better retention of nutrients.

Technological advancement in the industrial parboiling has resulted in enhanced process controls in the large-scale industrial parboiling units. But the enormous initial investments required for infrastructure, along with the time, labour and energy involved in paddy parboiling made it uneconomical for small scale milling and processing units to undertake parboiling. This investment and maintenance hurdles incurred during the parboiling process results in reduced involvement of Self-Help Groups like 'Kudumbasree'/ Farmers cooperative organizations, even though the sector offers potential.

Since the major share of people associated with paddy milling and parboiling process are women, development of an improved parboiling equipment with reduced drudgery and enhanced safety measures would significantly improve the employment prospects and thus will reflect in their standard of living. Hence, in the present study, a small scale gender-friendly parboiling cum drying unit was

developed and its performance evaluation was carried out based on the analysis of qualities of parboiled milled rice and cooked rice.

The developed parboiling cum drying unit consists of soaking cum steaming cylinder, LSU dryer, bucket elevator, steam boiler and heat furnace. The unit was fabricated using food grade material SS 304, to ensure safety. Soaking and steaming were carried out in the same chamber of capacity 100 kg/cylinder. The Steam boiler generates the steam at a pressure of 1 kg/cm² in the soaking cum steaming chamber. The bucket elevator with a capacity of 500 kg/h conveys the steamed paddy into LSU dryer and facilitates the drying process by continuous recirculation of paddy. The LSU dryer consist of inverted V channels which acts as air inlet and outlet ports. The hot air generated by burning of firewood in the furnace will heat up the interior ducts of the LSU drier.

The parboiling process were carried out for the paddy crop variety *Jyothi* at different combinations of soaking and steaming time and drying temperatures for the performance evaluation of the developed unit. Trials were conducted with two different methods of soaking *viz.* hot and cold soaking. Cold soaking method consists of keeping the paddy in normal water for 40 h, 50 h, and 60 h, respectively. The hot soaking consists of soaking the paddy at a temperature of 70°C with corresponding soaking time of 5h, 6 h and 7 h, respectively. The soaked paddy was subjected to steaming for a duration of 20 min, 25 min and 30 min. The steamed paddy was conveyed into the LSU dryer to achieve optimum moisture content suitable for milling. The required air temperature for heat furnace-based LSU dryer was fixed according to the optimum temperature obtained from hot air dryer which dried the paddy at three drying temperatures (50, 60 and 70°C). Seventeen treatment combinations were selected for both hot and cold soaking based on Response Surface Methodology Box Bhenken design.

The effect of varying parameters on the milling and cooking qualities of parboiled rice were analysed for the performance evaluation of the developed unit. The attributes to evaluate the effectiveness of milling were efficiency, head rice yield, hardness, bulk density, true density, and chalkiness of the parboiled milled

rice. Cooking time, water uptake ratio, grain elongation ratio, hardness and gruel solid loss were the cooking qualities measured for the evaluation. Statistical analysis was done to study the effect of varying parameters on the milling and cooking qualities based on RSM Box Bhenken design.

Milling efficiency of 66.7% and head rice yield of 88.67% were observed in hot soaking for paddy parboiled with a soaking duration of 7 h, steaming time of 25 min and drying temperature of 50°C. Cold soaking yielded a milling efficiency of 64.49% and head rice yield of 84.24% with a soaking duration of 40 h, steaming time of 25 min and drying temperature of 70°C. Milling efficiency and head rice yield increased with increase in the steaming time up to a certain limit (25 min) and later it decreased. Milling efficiency and head rice yield decreased with increase in the drying temperature.

The variation in steaming time and drying temperature had significant effect on the hardness of the milled parboiled rice. Hardness value of 90.38 N and 103.02 N were found respectively for hot and cold soaking that steamed for 25 min and dried at 50°C. Parboiling increased the chroma value and reduced the chalkiness in the rice kernel for both soaking methods. The bulk density and true density were not significantly affected by the parboiling process since it depended on the roundness of kernel and degree of milling.

The variation in steaming time had a significant effect on the cooking qualities of parboiled-milled rice. Cooking time of 24.52 min and 25.45 min and corresponding water uptake ratio of 2.43 and 2.62 were obtained for the steaming time of 30 min in hot soaking and cold soaking methods, respectively. The gruel solid loss was found to be decreased with increased duration of steaming. The hardness of the cooked rice improved as a consequence of parboiling.

Statistical analysis using RSM Box Benkhen design revealed that the milling efficiency, head rice yield and hardness of the parboiled milled rice followed a similar trend in the variation of steaming time and drying temperature. The increase in steaming time had a significant effect on the cooking properties of

the parboiled milled rice. The cooking time, water uptake ratio and grain elongation ratio had positive response with increase in steaming time and inversely associated to the gruel solid loss.

Soaking duration of 6.67 h, steaming duration of 26 min and drying temperature of 51.48°C was optimised as the best treatment combination for hot soaking. In case of cold soaking, the optimised treatment combination were 60 h soaking time, 27.24 min steaming time and 52.2°C drying temperature. The trials were conducted in the LSU dryer using the optimised temperature and the responses were verified. Optimised treatment combination gave better milling efficiency and higher head rice recovery, high hardness, less chroma value and a reduced solid gruel loss in both hot and cold soaking process. The time taken for the drying process was 4 h in both soaking methods.

The processing cost of parboiling and milling of one-kilogram paddy with the developed unit were Rs. 2.55/- and Rs. 2.0/-; respectively. The benefit cost ratio for the parboiling process was obtained as 1.33:1, which revealed that the developed unit was economically feasible.

In the present study, a small-scale parboiling cum drying unit was successfully developed for paddy processing with reduced drudgery and less human interventions. Further studies may be undertaken to improve this newly developed unit by replacing the heat furnace with a heat exchanger. Besides, the capacity of the parboiling unit could be enhanced by increasing the number of soaking cum steaming chambers. Moreover the huller used in the present study may be replaced by rubber roll shellers to improve the milling efficiency.

REFERENCES

REFERENCES

- A.O.A.C. 1980. Official Methods of Analysis. Association of Analytical Chemists. Arlindton, USA.
- Agrawal, A. K., Lavanya, K. and Sinha, G., 2015. Paddy parboiling for improved milling, better cooking and higher recovery of rice bran oil. *Madras Agric. J.* 102: 285-289.
- Ali, N. and Ojha, T. P. 1976. Parboiling. *Rice Postharvest Technology.* 163-204p.
- Ali, N. and Pandya, A. C., 1974. Basic concept of parboiling of paddy. *J. Agri. Eng Res.* 19: 111-115.
- Anggi, H. H., Seon, J. K. and Jong, B. E. 2016. Physical characteristics of parboiled korean glutinous rice (Olbyeossal) using a modified method. *Food Sci. Technol.* 68: 499-505.
- Anon., 2016. *Agricultural Processing Equipments: Value additions.* TNAU Agri tech Portal: Agricultural Engineering. Available: <http://www.agritech.tnau.ac.in>.
- Araullo, E. V., Padua, D. B. and Graham, M., 1976. *Rice postharvest technology.* Ottawa: International Development Research Centre, Canada. 394p.
- Ayamboo, A. J., Demuyakor, B., Saalia, F. K. and Francis A. 2014. Effect of varying parboiling conditions on cooking and eating / sensory characteristics of Jasmine 85 and Nerica 14 rice varieties. *Am. J. Food Technol.* 9: 1-14.
- Bandopadhyay, S. and Roy, N. C. 1976. Kinetics of absorption of liquid water by paddy grains during parboiling. *Ind. J. Technol.* 14: 27-32.
- Bas, D. and Boyaci, I. H. 2007. Modelling and optimisation I: usability of response surface surface methodology. *J. Food Eng.* 78(3): 836-845.

- Bello, M. O., Loubes, M. A., Aguerre, R. J. and Tolaba, M. P. 2015. Hydrothermal treatment of rough rice: Effect of processing conditions on product attributes. *J. Food Sci. Technol.* 52(8): 5156-5163.
- Bello, M., Baeza, R. and Tolaba, M. P. 2006. Quality Characteristics of milled and cooked rice affected by hydrothermal treatment. *J. Food Eng.* 72: 124-133.
- Bhattacharya, K. 2011. Rice Quality (1st Ed.). Woodhead Publishing Limited. Cambridge, UK.
- Bhattacharya, K. R. & Subba Rao, P. V., 1996. Effect of processing conditions on quality of parboiled rice. *J. Agric. food and food chem.* Volume 14, pp. 476-479.
- Bhattacharya, K. R. 1985. *Rice Chemistry and Technology*. USA: AACC, St. Paul, MA. 289-348p.
- Bhattacharya, K. K. 1985. Effect of parboiling on rice quality. *Rice Quality*. 247-297p.
- Bhattacharya, K. R. and Ali, S. Z. 1985. *Advance in Cereal Science and Technology*. AACC, St. Paul, M. N.
- Bhattacharya, K. R. and Rao, S. P. V. 1966. Effect of processing conditions on quality of parboiled rice. *J. Agric. Food Chem.* 14: 476-479.
- Bhattacharya, K. R. and Rao, S. P. V. 1996. Processing conditions and milling yield in parboiled rice. *J. Agric. food food chem.* 14: 473-475.
- Bhattacharya, K. R. and Swamy, Y. M. I. 1967. Conditions of drying parboiled paddy for optimum milling quality. *Cereal Chem.* 44: 592-600.
- Bhattacharya, K. R., 1969. Breakage of rice during milling and effect of parboiling. *Cereal chem.* 46(5): 478-485.
- Bualuang, O., Tirawanichakul, Y. and Tirawanichakul, S. 2013. Comparative study between hot air and infrared drying of parboiled rice: kinetics and quality Aspects. *J. Food Process Preserv.* 37: 1119-1132.

- Buggenhout, J., Brijis, K., Celus, I. and Delcour, J. A. 2013. The breakage susceptibility of raw and parboiled rice: A review. *J. Food Eng.* 17: 304-315.
- Chakraverty, A. 1981. *Post harvest technology of cereals and pulses*. Oxford and IBH Publishers, New Delhi.
- Champa, W. A. H., Fernando, M. D. and Palipane, K. B. 2006. Hydrothermal treatment to increase head rice yield and to improve palatability characteristics of rice. *Innovative Approaches in post harvest Eng. Technol.* 72-79p.
- Chavan, P., Sharma, S. R., Mittal, T. C. Mahajan, G. and Gupta, S. K. 2018. Effect of Parboiling Technique on Physico-chemical and Nutritional characteristics of Basmati Rice. *Agric Res. J.* 55(3): 490-499.
- Danbaba, N., Nkama, I., Badau, M. H., Ukwungwu, M. N., Maji, A. T., Abo, M. E., Hauwawu, H., Fati, K.I. and Oko, A. O. 2014. Optimization of Rice parboiling process for optimum Head Rice Yield: A Response Surface Methodology (RSM) Approach. *Int. J. Agric. Forestry.* 4(3): 154-165.
- Danbaba, N., Nkama, I., Badau, M. H., Ukwungwu, M. N., Maji, A. T., Abo, M. E., Hauwawy, H., Fati, K. I. and Oko, A. O. 2014. Optimization of Rice Parboiling Process for Optimum Head Rice Yield: A Response Surface Methodology (RSM) Approach. *Int. J. Agric. Forestry.* 4(3): 154-165.
- Das, S., Mukherjee, R. K. and Chakraverty, A. 2004. Development of production technique for crystalline parboiled rice.. *J. Agric. eng.* 23(1): 99-104.
- Dimick, D. 2014. Here's why we haven't quite figured out how to feed billions more people. National Geographic News, 4 Oct. 2014.
- Dutta, H. and Mahanta, C. L. 2012. Effect of hydrothermal treatment varying in time and pressure on the properties of parboiled rices with different amylose content. *Food Res. Int.* 49: 655-663.

- Dutta, H., Mahanta, C. L., Singh, V., Baruah, B. and Rahman, N. 2015. Physical, physicochemical and nutritional characteristics of Bhoja chaul, a traditional ready to eat dry parboiled rice product processed by an improvised soaking technique. *Food chem.*
- Ejebe, C., Danbaba, N. and Ngadi, M. 2015. Effect of steaming on physical and thermal properties of parboiled rice. *Eur. Int. J. of Sci. Technol.* 4(4): 71-80.
- FAOSTAT. 2019. FAOSTAT home page [on line]. Available: <http://www.fao.org/faostat/en/#data/QC>
- Fofana, M. 2011. Effect of improved parboiling methods on the physical and cooked grain characteristics of rice varieties in Benin. *Int. Food Res. J.* 18: 715-721.
- Gariboldi, F. 1974. *Rice processing*. Rome, Italy, Food and Agricultural Organisation of the United Nation. 97p.
- Gbabo, Agidi, Abdullahi, Lukman and Kuku, M. A. 2014. Design, Fabrication and testing of improved traditional Rice Parboiler. *Int. J. Eng. Tech. Res.* 2(9): 331-338.
- Goswami, T. K. and Murlidhar, M. 2015. Quick Parboiling, Drying and Milling of Paddy. *J. Food Dairy Technol.* 3(2): 37-42.
- Graham, S. A., Manful, J. T. Ndindeng, S. A. and Tchatcha, D. A.. 2015. Effects of soaking and steaming regimes on the quality of artisanal parboiled rice. *J. Food Process. Preserv.* 1-11p.
- Gunathilake, D. M. C. 2018. Application of two temperature hot water soaking for improving of paddy parboiling process. *Agric. Eng. Int.* 20(4): 164-168.
- Hall, C. W. 1970. Handling and Storage of Food Grains in Tropical and Subtropical Areas. *FAO Agricultural Development Paper.* 90p.

- Hapsari, A. H., Kim, S. J. and Eun, J. B. 2016. Physical characteristics of parboiled Korean glutinous rice (Olbyeossal) using a modified method. *LWT- Food Sci. and Technol.* 68: 499-505.
- Haque, A. K. M. A., Choudhury, N. H., Quasem, M. A. and Arboleda, J. R. 1997. Rice post - harvest practices and loss estimates in bangladesh -part III: Parboiling to milling. *Agric. Mech. Asia, Afr. and Latin Am.* 28(3): 51-55.
- Hasbullah, R. 2017. Steaming process of paddy to improve quality and reduce glycemic index of parboiled rice. *Acta Horti*: 1152p.
- Hashemi, J., Naoto, S. and Tushinori, K., 2005. *Controlled ambient aeration during rice storage II: Effects on rice quality.* ASAE Annual Meeting.
- Himjyoti and Dutta. 2016. Study on the effects of parboiling on rice and rice products of Assam. Ph.D (Food Eng. and Technology) thesis, Tezpur University, Tezpur.
- Houssou, P. and Amonsou, E. 2004. Development on improved parboiling equipment for paddy rice in benin. *Uganda J. Agril. Sci.* 9: 617-620.
- Igathinathane, C., Chattopadhyay, P. K. and Pordesimo, L. O. 2005. Combination soaking procedure for rough rice parboiling. *Trans. Am. Soc. Agric. Engineers.* 48(2): 665-671.
- IKISAN, 2019. Agri-Informatics and Services: Rice Marketing. Available: <http://www.ikisan.com/ka-rice-marketing.html>
- Ilyas, M. S. and Goel, R. K. 2003. Paper presented in the national Seminar on value addition in paddy held at Chennai: A solution to surplus production. 23-24p.
- Indiastat, 2020. Season-wise Area, Production and Productivity of Rice in India (1949-1950 to 2020-2021-1st Advance Estimates). Available: <https://www.indiastat.com/table/agriculture-data/2/rice-production/data>.

- Insprasit, C. and Noomhorm, A. 2001. Effect of drying air temperature and grain temperature of dryer and operation on rice quality. *Drying technol.* 19(2): 389-404.
- International Rice Research Institute (IRRI). 2009. Rice Knowledge bank. www.knowledgebank.irri.org.
- IRRI Rice knowledge bank. n.d. Drying Available: http://www.knowledgebank.irri.org/grainQuality/module_4/popups/pu_drying.htm
- Islam, M. D., Shimizu, N. and Kimura, T., 2001. Quality Evaluation of Parboiled Rice with Physical Properties. *Food Sci. Tehnol. Res.* 57-63p.
- Islam, M. R., Shimizu, N. and Kimura, T. 2003. Effect of processing conditions on cooking qualities of parboiled rice. *J. Jpn. Soc. Agr. Mach.* 65(23): 85-93.
- Islam, M. R., Shimizu, N. and Kimura, T. 2004. Energy requirement in parboiling and its relationship to some important quality indicators. *J. Food Eng.* 63: 433-139.
- Islam, R., Roy, P., Shimizu, N. and Kimura, T. 2002. Effect of processing conditions on physical properties of parboiled rice. *Food Sci. Technol. Res.* 8(2): 106-112.
- Itoh, K. and Kawamura, S. 1985. Processing conditions of parboiled rice and its qualities (Studies on parboiled rice part I). *Nippon Shokuhin Kogyo Gakkaishi.* 32: 471-479.
- Kashaninejad, M., Dehghani, A. A. and Kashiri, M. 2009. Modeling of wheat soaking using two artificial neural networks (MLP and RBF). *J. Food Eng.* 91: 602-607.
- Kashaninejad, M., Maghsoudlou, Y., Rafiee, S. and Morteza, K. 2007. Study of hydration kinetics and density changes of rice (Tarom Mahali) during hydro thermal processing. *J. Food Eng.* 39: 17-22.

- Kato, H., Ohta, T., Tsugita, T. and Hosaka, Y. (1983). Effect of parboiling on texture and flavor components of cooked rice. *J. Agric. Food Chem.* 31:818-823.
- Khatoon, N. & Prakash, J., 2007. Physico-chemical characteristics , cooking quality and sensory attributes of microwave cooked rice varieties. *Food Sci. Technol. Res.* 13(1): 35-40.
- Kimura, T. 1983. Properties of parboiled rice produced from Japanese paddy. *Agric. Mech. Asia, Afr. Latin Am.* 14(58): 31-33.
- Kimura, T. 1991. Effects of processing conditions on the hardening characteristics of parboiled grain. *J. Soc. Agric. Struct. Jpn.* 22(2): 49-54.
- Kondo, M. 2006. Analysis on the effects of air temperature during ripening and grain protien contents on grain chalkiness in rice. *Jpn J. Crop Sci.* 75: 234-235.
- Kondo, M., 2006. Analysis on the effects of air temperature during ripening and grain protien contents on grain chalkiness in rice. *Jpn J. crop Sci.* 75: 234-235.
- Kurien, P., Murty, R., Desikachar, H. and Subramanyan, V. 1964. Effect of parboiling on the swelling quality of rice. *Cereal Chem.* 41: 16-22.
- Lamberts, L. 2006. Effect of processing conditions on colour change of brown and milled parboiled rice. *Cereal chem.* 83: 80-85.
- Lan, Y. and Zheng, X. 2004. *Rice taste and quality affected by drying conditions.* Ottawa, Ontario, Canada.
- Larsen, H. N., Rasmussen, O. W., Rasmussen, P. H., Alstrup, K. K., Biswas, S. K., Tetens, I. Thilsted, S. H. and Hermansen, K. 2000. Glycemic Index of Parboiled rice depends on the severity of processing: study in type two Diabetic subjects. *European J. Clinical Nutri.* 54: 380-385.

- Leethanapanich, K., Mauromoustakos, A. and Wang, Y. J. 2016. Effect of soaking temperature on commingled rice properties. *J. Cereal Sci.* 69: 267-274.
- Levan, K. V., Regina, M. F., Sailaja, L. and Sajeev, M. S. 1990. Design and fabrication of husk fired inclined grate furnace and testing of CRRRI mini parboiling unit. B. Tech. (Ag. Eng.) report, Kerala Agricultural University, Thrissur.
- Lin, Z., Zheng, D., Zhang, X., Wang, Z., Lei, J. and Lui, Z. 2016. Chalky part differs in chemical composition from translucent part of japonica rice grains as revealed by a notched-belly mutant with white-belly. *J. Sci. Food Agric.* 96: 3937-3943.
- Litchfield, J. B. and Okos, M. R., 1988. Prediction of corn kernel stress and breakage induced by drying, tempering and cooling. *Trans. ASAE.* 31: 585-594.
- Luh, B. S. and Mikus, R. R., 1980. Parboiled rice in rice production and utilization. 501-542p.
- Luz, M. L. G. S., Elias, M. C. and Luz, C. A. S., 1993. *Evaluation of tempering time for parboiled rice.* University dade Federal de Pelotas, Pelotas RS, Brazil. 190p.
- Lyon, B. G. 1999. Effects of degree of milling, drying condition and moisture content on sensory texture of cooked rice. *Cereal Chem.* 76(1): 56-62.
- Manful, J. T., Abbey, L. D. and Coker, R. D. 2009. Effect of artisanal parboiling methods on milling yield and cooked rice textural characteristics. *J. Food Quality.* 32: 725-734.
- Manful, J. T., Grimm, C. C., Gayin, J. and Coker, R. D. 2008. Effect of variable parboiling on crystallinity of rice samples. *Cereal Chem.* 85: 92-95.

- Marshall, W. E., Wadsworth, J. I., Verma, L. R. and Velupillai, L. 1993. Determining the degree of gelatinisation in parboiled rice: comparison of a subjective and objective method. *J. Cereal Chem.* 70(2) : 226-230.
- Meresa, A., Demissew, A., Yilma, S., Tegege, G. and Temesgen, K. 2020. Effect of parboiling conditions on physical and cooking quality of selected rice varieties. *Int. J. Food Sci.* 1-9p.
- Miah, M. A. K., Haque, A., Douglass, M. P. and Clarke, B. 2002. Effect of hot soaking time on the degree of starch gelatinisation parboiling of rice. *Int. J. Food Sci. Technol.* 37(5): 539 - 545.
- Miah, M. A. K., Haque, A., Douglass, M. P. and Clarke, B. 2002. Parboiling of rice. Part I: Effect of hot soaking time on quality of milled rice. *Int. J. Food Sci. Technol.* 37: 527-537.
- Mohanty, S. N., Bal, S., Das, S. K. and Panda, M. K. J. 2002. Effects of hydrostatic parboiling on milling quality of rice. *J. Agril. Eng.* 39(2): 9-14.
- Mustapha, F.O. 1979. The effect of parboiling on some physicochemical properties of some local rice varieties. B.Sc. thesis, University of Ife, Nigeria.
- Naik, R., Murty, R. K. G. R. and Virakramath, B. C. 2006. Value addition of selected rice hybrids through parboiling. *Oryza.* 43(1): 48-50.
- Nayak, P. 1996. Problems and prospects of rice mill modernization; a case study. *J. Assam Univ.* 1(1): 22-28.
- Ndindeng, S. A., Manful, J. T., Futakuchi, K., Mapiemfu, D.L. and Etoa, A. 2015. A novel artisanal parboiling technology for rice processors in sub-Saharan Africa. *Food Sci. and Nutr.* 3(6): 557-568.
- Ogunbiyi, M. O., Adejumo, B. A., Gbabo, A. and Chinma, C. E. 2018. Optimisation of parboiling Process using Response Surface Methodology (RSM) to improve the Physical Properties of Parboiled Milled Rice. *Int. J. Eng. Res. Technol.* 7(7): 312-318.

- Oko, A. O., Ubi, B. E. and Dambaba, N. 2012. Rie cooking quality and physico-chemical characteristics: a comparative Analysis of Selected Local and Newly Introduced Rice Varieties in Ebonyi state, Nigeria. *Food Public Health*. 2(1): 43-49.
- Oli, P., Ward, R., Adhikari, B. and Torley, P. 2014. Parboiled rice: Understanding from a material science vapproach. *J. Food Eng.*124: 173-183.
- Ondier, G. O., Siebenmorgen, T. and Mauromoustakos, A. 2012. Drying characteristics and milling quality of rough rice dried in a single pass incorporating glass transition principles. *Dry Technol.* 30: 1821-1830.
- Otegbayo, B. O., Osamuel, F. and Fashakin, J. B. 2001. Effect of parboiling on physico- chemical qualities of two local rice varieties in Nigeria. *J. Food Technol. Afr.* 6: 130-132.
- Pal, P., Singh, N., Kaur, P. amd Kaur, A. 2018. Effect of parboiling on phenolic, protein and pasting properties of rice from different paddy varieties. *J. Food Sci.* 1:1-11
- Panigrahi, A. K., Mishra, S. and Mohapatra, U. 2019. Economics of small-scale mill in Ganjam district of Odisha. *J. Pharmacogn. Phytochem.* 8(2): 1579-1582.
- Parnsakhorn, S. and Noomhorm, A. 2008. Changes in physicochemical properties of parboiled brown rice during heat treatment. *Agric. Eng. Int. CIGR.* 8: 1-20.
- Patindol, J., Newton, J. and Wang, Y. J. 2008. Functional properties as affected by laboratory - scale parboiling of rough rice and brown rice. *J. Food Sci.* 73(8): 370-377.
- Piillaiyar, P. 1995. *Influence of processing variables on the production and quality of parboiled rices*. Unpublished PhD thesis, Annamalai University, Annamalai Nahar.

- Pillaiyar, P. 1990. Rice: Postproduction Manual. Wiley Eastern Ltd. New Delhi, India.
- Pillaiyar, P. and Mohandoss, R, 1981. Hardness and colour in parboiled rices produced at low and high temperatures. *J. Food Sci. Technol.* 18: 7-9.
- Pillaiyar, P., Vasan, B. S., Rajendran, G. and Dhamarajan, V. 1980. Prevention of foul odour and minimizing soaking loss in conventional parboiling of paddy. *J. Food Sci. Technol.* 17: 228-230.
- Rahaman, M. A., Miah, M. A. K. and Ahmed, A. 1996. Status of rice processing technology in bangladesh in Bangladesh. *Agric. Mech. in Asia, Afr. Latin Am.* 27: 46-50.
- Ramachandra, Y. V., Subramanian, D. K., Joshi, N. V. and Gunaga, S. V. 2000. Domestic energy consumption pattern in utara kannada District, Karnataka state. *Indian J. Energy Conserv. Manag.* 41: 775-831.
- Ramesh, M., Ali, S. Z. and Bhattacharya, K. R. 1999. Structure of rice starch and its relation to cooked rice texture. *Carbohydr. Polym.* 38: 337-347.
- Rao, P. S., Bal, S. and Goswami, T. K. 2007. Modelling and optimization of drying variables in thin layer drying of parboiled paddy. *J. Food Eng.* 78: 480-487.
- Rockembach, C. T., Halal, S. L. M. E., Mesko, M. F., Gutkoski, L. C., Elias, M. C. and Oliveira, M. D. 2019. Morphological and physicochemical properties of rice grains submitted to rapid parboiling by microwave irradiation. *LWT-Food Sci. Technol.* 103: 44-52.
- Roseline, B.T.M., Fofana, M., Innocent, B. and Futakuchi, K. 2010. Effect of parboiling and storage on grain physical and cooking characteristics of the some NERICA rice varieties. Innovations and Partnerships to Realize Africa's Rice Potential. Second Africa Rice Congress, Bamako, Mali.
- Roy, P., Shimizu, N., Furuichi, S. and Kimura, T. 2003. Improvement of traditional parboiling process. *J. Jpn. Soc. Agric. Mach.* 65(1): 159-166.

- Roy, P., Shimizu, N., Shiina, T. and Kimura T. 2006. Energy consumption and cost analysis of local parboiling processes. *J. Food Eng.* 646-655p.
- Roy, P., Shimizu, N., Shiina, T. and Kimura, T. 2003. Life cycle inventory analysis of local parboiling processes. *J. Jpn Soc. Agric. Mach.* 67(1): 61-67.
- Saeed, F., Pasha, I., Anjum, F. M., Suleria, H. A. R. and Farooq, M. 2011. Effect of parboiling on physicochemical and cooking attributes of different rice cultivars. *Int. J. Food Safety.* 13: 237-245.
- Sahay, K. M. and Singh, K. K. 2001. *Unit operations of agricultural processing (2nd Ed.)*. Vikas Publishing House Pvt. Ltd, New Delhi, 274p.
- Saifullah, M. H. S., Dwyane, A., Suter and Lan, Y. 2004. Effect of steaming, drying, storage and loading rate on the stress relation constant of parboiled rice. *Am. Soc. Agric. Biol. Eng.*
- Saikrishna, A., Dutta, S., Subramanian, V. and Moses, J.A. 2013. Ageing of rice: A review. *J. Cereal Sci.* 81: 161-170.
- Samsher and Narain, M. 1989. Fissuring and milling behaviour of paddy as influenced by drying air temperature. *IE (I) J.* 69: 66-72.
- Sareepuang, K., Siriamornpun, S., Wiset, L. Meeso, N., 2008. Effect of soaking temperature on physical, chemical and cooking properties of parboiled Fragrant rice. *World J. Agric. Sci.* 4(4): 409-415.
- Saxena, G. K., Bal, S. and Siripurupu, S. C. B. 1989. Effect of continous steaming under pressure on the quality of rice parboiled at different initial moisyure contents. *J. Agric. Eng.* 26(3): 282-288.
- Shrivastava, A. K. and Narain, M. 1990. Effect of grain fissuring on milling quality of paddy. *J. Inst. of Eng.* 71: 6-9.
- Shwetha, M. K. 2011. Economics of Paddy Processing: A comparative analysis of Conventional and Modern Rice Mills, Karnataka. *J. Agri. Sci.* 24(3): 331-335.

- Simi, V. P. & Sudeep, P. S., 2006. Studies on Pressure parboiling of paddy. B. Tech (Agric. Eng.) report, Kerala Agricultural university.
- Sindhu, S. J., Gill, M. S. and Bains, G. S. 1975. Milling of paddy in relation to yield and quality of rice of different Indian varieties. *J. Agric. Food Chem.* 23(6): 1183-1185.
- Singha, K. 2012. Economics of paddy processing industry in India: a case of Karnataka. *Sci. J. Agric.* 1(4): 80-91.
- Soponronnarit, S., Nathakaranakule, A., Jirajindalert, A. and Taechapiroj, C. 2005. Parboiling brown rice using super heated steam fluidisation technique. *J. Food Eng.* 75: 423-432.
- Srisang, N. and Chungchaoren, T. 2019. Quality attributes of parboiled rice prepared with a parboiling process using a rotating sieve system. *J. Cereal Sci.* 85: 286-294.
- Statista, 2020. Global rice consumption 2019/20. Available: <https://www.statista.com/statistics/255977/total-global-rice-consumption/>
- Swasdisevi, T., Sriariyakula, W., Tia, W. and Soponronnarit, S., 2010. Effect of pre-steaming on production of partially-parboiled rice using hot-air fluidization technique. *J. Food Eng.* 96: 455-462.
- Taghinezhad, E., Khoshtaghaza, M. H., Minaei, S. Suzuki, T. 2016. Relationship between degree of starch gelatinisation and quality attributes of parboiled rice during steaming. *Rice Sci.* 23(6): 339-344.
- Taghinezhad, E., Khoshtaghaza, M. H., Minaei, S. and Latifi, A. 2015. Effect of soaking temperature and steaming time on the quality of parboiled Iranian Paddy Rice. *Int. J. Food Eng.*, 11(4): 547-556.
- Tetens, S. K., Biswas, L. V., Gilts, K. A., Kabir, S. H., Thilsted, T. and Choudhury, N. H. 1997. Physico-chemical characteristics as indicators of starch availability from milled rice. *J. Cereal Sci.*, Volume 26, pp. 355-361.

- Tian, Y., Zhao, J., Xie, Z., Wang, J., Xu, X. and Jin, Z. 2014. Effect of different pressure- soaking treatments on colour, texture, morphology and retrogradation properties of cooked rice. *LWT- Food Sci. Technol.* 55(1): 368-373.
- Umogbai, V. I. (2013). Development of a farm level paddy rice parboiling device. *Int. J. Recent Technol. Eng.* 2(2): 16-21.
- Varadharaju, N. and Sreenarayanan, V. 2004. Energy requirement for conduction parboiling paddy. *J. Irrig. Eng.* 85: 37-43.
- Vassan, B. S. 1982. Improvement of quality of parboiled rice in the modern mills. *J. Agric. Eng.* 19: 59-60.
- Velupillai, L. and Verma, L. R. 1986. Drying and effects on parboiled rice quality tempering. *Trans. ASAE.* 29(1): 312-319.
- Wahengbam, E. D. and Hazarika, M. K. 2019. Quality of ready-to-eat komal chawal produced by brown rice parboiling method. *J. Food Sci. Technol.* 56(1): 187-199.
- Wiset, L. 2001. Effects of high temperature drying on rice quality. *Agric. Eng. Int.* Volume 3.
- Xiaonan, X. 2019. Effect of ultra-high pressure on quality characteristics of parboiled rice. *J. Cereal Sci.* 87: 117-123.
- Yolmeh, M. and Jafari, S. M. 2017. Applications of Response Surface Methodology in the Food Industry Processes. *Food Bioprocess Technol.* 10: 413-433.
- Yousaf, K. Kunjie, C. Cairong, C. Abbas, A. Huang, Y. Arslan, C. and Xuejin, Z. 2017. The Optimization and Mathematical Modeling of Quality Attributes of Parboiled Rice Using a Response Surface Method. *J. Food Quality.* 1-12p.
- Zheng, X. and Lan, Y. 2007. Effects of Drying Temperature and Moisture Content on Rice Taste Quality. *Agric. Eng. Int.* 9: 1-9.

Zohoun, E. V., Tang, E. N., Soumanou, M. M., Manful, J. Akissoe, N. H., Bigoga, J. Futakuchi, K. Ndindeng, S. A. 2017. Physicochemical and nutritional properties of rice as affected by parboiling steaming time at atmospheric pressure and variety. *Food Sci. Nutr.* 6: 638-652.

APPENDICES

APPENDIX A

Table A1. Effect of parboiling on milling efficiency and head rice yield in hot soaking

Run	Soaking time (h)	Steaming time (min)	Drying temperature (°C)	Milling efficiency (%)	Head Rice yield (%)
1	5	20	60	57.847	79.113
2	7	20	60	61.387	83.546
3	5	30	60	50.177	72.054
4	7	30	60	50.509	72.113
5	5	25	50	64.004	85.589
6	7	25	50	66.715	88.677
7	5	25	70	56.053	79.095
8	7	25	70	59.956	82.496
9	6	20	50	59.088	81.881
10	6	30	50	58.789	81.465
11	6	20	70	54.614	77.395
12	6	30	70	49.016	71.675
13	6	25	60	63.573	85.951
14	6	25	60	63.022	85.333
15	6	25	60	63.819	86.333
16	6	25	60	63.959	86.511
17	6	25	60	63.497	85.834

Table A2. Analysis of variance (ANOVA) for milling efficiency in hot soaking

Source	Sum of Squares	df	Mean Sums of Square	F Value	p-value Prob > F	Coeff. Est.	df	SE	95% CI Low	95% CI High
Model	453.22	9	50.36	16.4	0.0006	63.57	1	0.7836	61.72	65.43
A-Soaking time	13.75	1	13.75	4.48	0.0721	1.31	1	0.6195	-0.154	2.78
B-Steamig time	74.7	1	74.7	24.33	0.0017	-3.06	1	0.6195	-4.52	-1.59
C-Dryig temperature	104.81	1	104.81	34.14	0.0006	-3.62	1	0.6195	-5.08	-2.15
AB	2.57	1	2.57	0.8377	0.3905	-0.8018	1	0.8761	-2.87	1.27
AC	0.3555	1	0.3555	0.1158	0.7436	0.2981	1	0.8761	-1.77	2.37
BC	7.02	1	7.02	2.29	0.1743	-1.32	1	0.8761	-3.4	0.7468
A ²	5.52	1	5.52	1.8	0.222	-1.14	1	0.8539	-3.16	0.8746
B ²	233.69	1	233.69	76.12	< 0.0001	-7.45	1	0.8539	-9.47	-5.43
C ²	2.35	1	2.35	0.7668	0.4102	-0.7477	1	0.8539	-2.77	1.27
Residual	21.49	7	3.07							
Lack of Fit	20.97	3	6.99	53.86	0.0011					
Pure Error	0.5191	4	0.1298							
Cor Total	474.71	16								
Std. Dev.	1.75	R-Squared		0.9547	df= degrees of freedom; SE= Standard Error					
Mean	59.18	Adj R-Squared		0.8965	Coeff. Est = Coefficient of estimate					
C.V. %	2.96	Pred R-Squared		0.2915	CI = Confidence of Interval					
		Adeq Precision		14.0923	ns= non significance					

Table A3. Analysis of variance (ANOVA) for head rice yield in hot soaking

Source	Sum of Squares	df	Mean Sums of Square	F Value	p-value Prob > F	Coeff. Est.	df	SE	95% CI Low	95% CI High
Model	456.62	9	50.74	17.12	0.0006	85.99	1	0.7698	84.17	87.81
A-Soaking time	15.07	1	15.07	5.09	0.0587	1.37	1	0.6086	-0.0665	2.81
B-Steamig time	75.81	1	75.81	25.59	0.0015	-3.08	1	0.6086	-4.52	-1.64
C-Dryig temperature	90.78	1	90.78	30.64	0.0009	-3.37	1	0.6086	-4.81	-1.93
AB	4.78	1	4.78	1.61	0.2445	-1.09	1	0.8606	-3.13	0.9416
AC	0.0246	1	0.0246	0.0083	0.93	0.0784	1	0.8606	-1.96	2.11
BC	7.04	1	7.04	2.38	0.1672	-1.33	1	0.8606	-3.36	0.7087
A ²	12.33	1	12.33	4.16	0.0807	-1.71	1	0.8388	-3.7	0.272
B ²	241.4	1	241.4	81.48	< 0.0001	-7.57	1	0.8388	-9.56	-5.59
C ²	0.4153	1	0.4153	0.1402	0.7192	-0.3141	1	0.8388	-2.3	1.67
Residual	20.74	7	2.96							
Lack of Fit	19.9	3	6.63	31.76	0.003					
Pure Error	0.8355	4	0.2089							
Cor Total	477.36	16								
Std. Dev.	1.72		R-Squared	0.9566		df= degrees of freedom; SE= Standard Error				
Mean	81.47		Adj R-Squared	0.9007		Coeff. Est = Coefficient of estimate				
C.V. %	2.11		Pred R-Squared	0.3301		CI = Confidence of Interval				
			Adeq Precision	13.8594		ns= non significance				

Table A4. Effect of parboiling on qualities of milled rice in hot soaking

Run	Soaking time (h)	Steaming time (min)	Drying temperature (°C)	Hardness (N)	Chroma (B)	Bulk density (g/cm ³)	True density (g/cm ³)	Chalkiness
1	5	20	60	76.257	32.402	0.813	1.429	3
2	7	20	60	77.401	33.721	0.847	1.398	9
3	5	30	60	73.160	33.827	0.819	1.371	8
4	7	30	60	75.876	35.071	0.865	1.456	4
5	5	25	50	86.338	32.354	0.819	1.380	8
6	7	25	50	90.338	32.771	0.813	1.404	7
7	5	25	70	74.582	33.392	0.833	1.405	9
8	7	25	70	76.906	34.377	0.820	1.435	2
9	6	20	50	85.338	32.043	0.793	1.427	6
10	6	30	50	83.337	34.167	0.823	1.420	5
11	6	20	70	72.642	33.007	0.801	1.386	9
12	6	30	70	70.472	34.255	0.806	1.379	4
13	6	25	60	79.920	33.133	0.827	1.465	8
14	6	25	60	78.957	33.474	0.819	1.420	7
15	6	25	60	79.062	33.622	0.817	1.423	6
16	6	25	60	79.169	33.502	0.813	1.424	8
17	6	25	60	79.281	33.402	0.809	1.422	5

Table A5 Analysis of variance (ANOVA) for hardness of milled rice in hot soaking

Source	Sum of Squares	df	Mean Sums of Square	F Value	p-value Prob > F	Coeff. Est.	df	SE	95% CI Low	95% CI High
Model	431.04	9	47.89	243.61	< 0.0001	79.28	1	0.1983	78.81	79.75
A-Soaking time	12.96	1	12.96	65.92	< 0.0001	1.27	1	0.1568	0.9021	1.64
B-Steamig time	9.66	1	9.66	49.16	0.0002	-1.1	1	0.1568	-1.47	0.7284
C-Dryig temperature	321.93	1	321.93	1637.54	< 0.0001	-6.34	1	0.1568	-6.71	-5.97
AB	0.6176	1	0.6176	3.14	0.1196	0.3929	1	0.2217	-0.1313	0.9172
AC	0.7027	1	0.7027	3.57	0.1006	-0.4191	1	0.2217	-0.9434	0.1051
BC	0.0071	1	0.0071	0.0361	0.8547	-0.0421	1	0.2217	-0.5664	0.4821
A ²	0.2519	1	0.2519	1.28	0.2949	0.2446	1	0.2161	-0.2664	0.7556
B ²	62.39	1	62.39	317.34	< 0.0001	-3.85	1	0.2161	-4.36	-3.34
C ²	26.71	1	26.71	135.85	< 0.0001	2.52	1	0.2161	2.01	3.03
Residual	1.38	7	0.1966							
Lack of Fit	0.8021	3	0.2674	1.86	0.2766					
Pure Error	0.5741	4	0.1435							
Cor Total	432.42	16								
Std. Dev.	0.4434	R-Squared			0.9968	df= degrees of freedom; SE= Standard Error				
Mean	78.77	Adj R-Squared			0.9927	Coeff. Est = Coefficient of estimate				
C.V. %	0.5629	Pred R-Squared			0.9682	CI = Confidence of Interval				
		Adeq Precision			57.6779	ns= non significance				

Table A6. Analysis of variance (ANOVA) for chroma of milled rice in hot soaking

Source	Sum of Squares	df	Mean Sums of Square	F Value	p-value Prob > F	Coeff. Est.	df	SE	95% CI Low	95% CI High
Model	9.28	9	1.03	10.88	0.0024	33.43	1	0.1377	33.1	33.75
A-Soaking time	1.97	1	1.97	20.75	0.0026	0.4957	1	0.1088	0.2383	0.753
B-Steamig time	4.73	1	4.73	49.89	0.0002	0.7686	1	0.1088	0.5113	1.03
C-Dryig temperature	1.71	1	1.71	18.02	0.0038	0.462	1	0.1088	0.2047	0.7193
AB	0.0014	1	0.0014	0.0149	0.9061	-0.0188	1	0.1539	-0.3827	0.3451
AC	0.0808	1	0.0808	0.8529	0.3865	0.1421	1	0.1539	-0.2218	0.5061
BC	0.1918	1	0.1918	2.02	0.1977	-0.219	1	0.1539	-0.5829	0.1449
A ²	0.0357	1	0.0357	0.3768	0.5587	0.0921	1	0.15	-0.2626	0.4468
B ²	0.2353	1	0.2353	2.48	0.159	0.2364	1	0.15	-0.1183	0.5911
C ²	0.367	1	0.367	3.87	0.0897	-0.2952	1	0.15	-0.65	0.0595
Residual	0.6632	7	0.0947							
Lack of Fit	0.5301	3	0.1767	5.31	0.0703					
Pure Error	0.1331	4	0.0333							
Cor Total	9.94	16								
Std. Dev.	0.3078	R-Squared			0.9333	df= degrees of freedom; SE= Standard Error				
Mean	33.44	Adj R-Squared			0.8475	Coeff. Est = Coefficient of estimate				
C.V. %	0.9204	Pred R-Squared			0.1261	CI = Confidence of Interval				
		Adeq Precision			13.0571	ns= non significance				

Table A7. Analysis of variance (ANOVA) for bulk density of milled rice in hot soaking

Source	Sum of Squares	df	Mean Sums of Square	F Value	p-value Prob > F	Coeff. Est.	df	SE	95% CI Low	95% CI High
Model	0.0031	9	0.0003	1.54	0.2912	0.8173	1	0.0067	0.8016	0.8331
A-Soaking time	0.0005	1	0.0005	2.14	0.1872	0.0077	1	0.0053	-0.0048	0.0201
B-Steamig time	0.0005	1	0.0005	2.14	0.1873	0.0077	1	0.0053	-0.0048	0.0201
C-Dryig temperature	0	1	0	0.0633	0.8086	0.0013	1	0.0053	-0.0111	0.0138
AB	0	1	0	0.1499	0.7102	0.0029	1	0.0074	-0.0147	0.0205
AC	0	1	0	0.046	0.8362	-0.0016	1	0.0074	-0.0192	0.016
BC	0.0001	1	0.0001	0.6035	0.4627	-0.0058	1	0.0074	-0.0234	0.0118
A ²	0.0013	1	0.0013	5.85	0.0462	0.0176	1	0.0073	0.0004	0.0347
B ²	0	1	0	0.0534	0.8239	0.0017	1	0.0073	-0.0155	0.0188
C ²	0.0007	1	0.0007	3.24	0.1148	-0.0131	1	0.0073	-0.0302	0.0041
Residual	0.0016	7	0.0002							
Lack of Fit	0.0014	3	0.0005	9.7	0.0262					
Pure Error	0.0002	4	0							
Cor Total	0.0046	16								
Std. Dev.	0.0149	R-Squared			0.6645	df= degrees of freedom; SE= Standard Error				
Mean	0.8202	Adj R-Squared			0.2331	Coeff. Est = Coefficient of estimate				
C.V. %	1.82	Pred R-Squared			-3.7833	CI = Confidence of Interval				
		Adeq Precision			5.5767	ns= non significance				

Table A8. Analysis of variance (ANOVA) for True density of milled rice in hot soaking

Source	Sum of Squares	df	Mean Sums of Square	F Value	p-value Prob > F	Coeff. Est.	df	SE	95% CI Low	95% CI High
Model	0.0071	9	0.0008	1.44	0.323	1.43	1	0.0105	1.41	1.46
A-Soaking time	0.0015	1	0.0015	2.73	0.1426	0.0137	1	0.0083	-0.0059	0.0333
B-Steamig time	0	1	0	0.0497	0.83	-0.0018	1	0.0083	-0.0214	0.0177
C-Dryig temperature	0.0001	1	0.0001	0.1479	0.712	-0.0032	1	0.0083	-0.0228	0.0164
AB	0.0033	1	0.0033	6.06	0.0433	0.0289	1	0.0117	0.0011	0.0566
AC	9.30E-06	1	9.30E-06	0.0169	0.9001	0.0015	1	0.0117	-0.0262	0.0292
BC	1.38E-07	1	1.38E-07	0.0003	0.9878	0.0002	1	0.0117	-0.0275	0.0279
A ²	0.0002	1	0.0002	0.3891	0.5525	-0.0071	1	0.0114	-0.0341	0.0199
B ²	0.0004	1	0.0004	0.813	0.3972	-0.0103	1	0.0114	-0.0373	0.0167
C ²	0.0013	1	0.0013	2.39	0.1657	-0.0177	1	0.0114	-0.0447	0.0093
Residual	0.0038	7	0.0005							
Lack of Fit	0.0024	3	0.0008	2.14	0.2384					
Pure Error	0.0015	4	0.0004							
Cor Total	0.011	16								
Std. Dev.	0.0234	R-Squared			0.6491	df= degrees of freedom; SE= Standard Error				
Mean	1.41	Adj R-Squared			0.1979	Coeff. Est = Coefficient of estimate				
C.V. %	1.66	Pred R-Squared			-2.6679	CI = Confidence of Interval				
		Adeq Precision			4.7325	ns= non significance				

Table A9. Effect of parboiling on qualities of cooked rice in hot soaking

Treatments	Soaking time (h)	Steaming time (min)	Drying temperature (°C)	Cooking time (min)	Water uptake ratio	Gruel solid loss (g/g)	Grain elongation ratio	Hardness (N)
1	5	20	60	20:51	1.651	0.0529	1.4275	10.57
2	7	20	60	21:53	1.776	0.0520	1.4336	11.15
3	5	30	60	23:28	2.309	0.0460	1.4401	14.21
4	7	30	60	22:33	1.655	0.0448	1.6161	15.06
5	5	25	50	21:38	1.746	0.0548	1.5951	11.01
6	7	25	50	22:00	1.796	0.0532	1.6196	11.95
7	5	25	70	21:34	1.722	0.0483	1.4811	14.25
8	7	25	70	22:15	2.008	0.0466	1.4702	14.91
9	6	20	50	21:13	1.680	0.0558	1.4755	9.95
10	6	30	50	23:51	1.932	0.0483	1.5367	13.01
11	6	20	70	20:43	1.639	0.0530	1.4752	12.59
12	6	30	70	24:52	2.435	0.0446	1.5341	16.43
13	6	25	60	22:04	1.858	0.0487	1.4538	12.93
14	6	25	60	22:15	1.953	0.0480	1.4471	12.52
15	6	25	60	22:07	1.982	0.0479	1.4496	12.49
16	6	25	60	22:09	1.996	0.0482	1.4512	12.23
17	6	25	60	22:03	2.001	0.0484	1.4489	12.48

Table A10. Analysis of variance (ANOVA) for cooking time of cooked rice in hot soaking

Source	Sum of Squares	df	Mean Sums of Square	F Value	p-value Prob > F	Coeff. Est.	df	SE	95% CI Low	95% CI High	VIF
Model	56835.83	9	6315.09	7.31	0.0078	1327.6	1	13.14	1296.52	1358.68	1327.6
A-Soaking time	612.5	1	612.5	0.7092	0.4275	8.75	1	10.39	-15.82	33.32	8.75
B-Steaming time	45602	1	45602	52.8	0.0002	75.5	1	10.39	50.93	100.07	75.5
C-Dryig temperature	220.5	1	220.5	0.2553	0.6289	5.25	1	10.39	-19.32	29.82	5.25
AB	3422.25	1	3422.25	3.96	0.0868	-29.25	1	14.69	-64	5.5	-29.25
AC	90.25	1	90.25	0.1045	0.7559	4.75	1	14.69	-30	39.5	4.75
BC	2070.25	1	2070.25	2.4	0.1655	22.75	1	14.69	-12	57.5	22.75
A ²	2070.44	1	2070.44	2.4	0.1655	-22.17	1	14.32	-56.04	11.69	-22.17
B ²	2808.13	1	2808.13	3.25	0.1144	25.83	1	14.32	-8.04	59.69	25.83
C ²	168.44	1	168.44	0.195	0.6721	6.32	1	14.32	-27.54	40.19	6.32
Residual	6045.7	7	863.67								
Lack of Fit	5954.5	3	1984.83	87.05	0.0004						
Pure Error	91.2	4	22.8								
Cor Total	62881.53	16									
Std. Dev.	29.39	R-Squared			0.9039	df= degrees of freedom; SE= Standard Error					
Mean	1332.29	Adj R-Squared			0.7802	Coeff. Est = Coefficient of estimate					
C.V. %	2.21	Pred R-Squared			-0.5174	CI = Confidence of Interval					
		Adeq Precision			10.8919	ns= non significance					

Table A11. Analysis of variance (ANOVA) for Water uptake ratio of cooked rice in hot soaking

Source	Sum of Squares	df	Mean Sums of Square	F Value	p-value Prob > F	Coeff. Est.	df	SE	95% CI Low	95% CI High
Model	0.665	9	0.0739	3.46	0.0578	1.96	1	0.0653	1.8	2.11
A-Soaking time	0.0047	1	0.0047	0.218	0.6548	-0.0241	1	0.0517	-0.1462	0.098
B-Steamig time	0.3136	1	0.3136	14.69	0.0064	0.198	1	0.0517	0.0758	0.3201
C-Dryig temperature	0.0528	1	0.0528	2.48	0.1597	0.0813	1	0.0517	-0.0409	0.2034
AB	0.1516	1	0.1516	7.1	0.0322	-0.1946	1	0.073	-0.3674	-0.0219
AC	0.0139	1	0.0139	0.6509	0.4463	0.0589	1	0.073	-0.1138	0.2317
BC	0.0738	1	0.0738	3.46	0.1054	0.1358	1	0.073	-0.0369	0.3085
A ²	0.048	1	0.048	2.25	0.1772	-0.1068	1	0.0712	-0.2752	0.0615
B ²	0	1	0	0.002	0.9655	-0.0032	1	0.0712	-0.1715	0.1652
C ²	0.0045	1	0.0045	0.2123	0.6589	-0.0328	1	0.0712	-0.2012	0.1355
Residual	0.1494	7	0.0213							
Lack of Fit	0.1356	3	0.0452	13.06	0.0156					
Pure Error	0.0138	4	0.0035							
Cor Total	0.8144	16								
Std. Dev.	0.1461	R-Squared		0.8166	df= degrees of freedom; SE= Standard Error					
Mean	1.89	Adj R-Squared		0.5807	Coeff. Est = Coefficient of estimate					
C.V. %	7.73	Pred R-Squared		-1.6897	CI = Confidence of Interval					
		Adeq Precision		7.6535	ns= non significance					

Table A12. Analysis of variance (ANOVA) for Gruel solid loss of cooked rice in hot soaking

Source	Sum of Squares	df	Mean Sums of Square	F Value	p-value Prob > F	Coeff. Est.	d f	SE	95% CI Low	95% CI High
Model	0.0002	9	0	22.4	0.0002	0.0483	1	0.0004	0.0473	0.0493
A-Soaking time	3.88E-06	1	3.88E-06	4.32	0.0762	-0.0007	1	0.0003	-0.0015	0.0001
B-Steaming time	0.0001	1	0.0001	123.73	< 0.0001	-0.0037	1	0.0003	-0.0045	0.0029
C-Dryig temperature	0	1	0	52.82	0.0002	-0.0024	1	0.0003	-0.0032	0.0016
AB	1.27E-08	1	1.27E-08	0.0141	0.9088	-0.0001	1	0.0005	-0.0012	0.0011
AC	5.29E-10	1	5.29E-10	0.0006	0.9813	0	1	0.0005	-0.0011	0.0011
BC	1.97E-07	1	1.97E-07	0.2193	0.6538	-0.0002	1	0.0005	-0.0013	0.0009
A ²	1.02E-06	1	1.02E-06	1.13	0.3231	0.0005	1	0.0005	-0.0006	0.0016
B ²	1.39E-07	1	1.39E-07	0.1549	0.7056	0.0002	1	0.0005	-0.0009	0.0013
C ²	0	1	0	18.32	0.0037	0.002	1	0.0005	0.0009	0.0031
Residual	6.29E-06	7	8.98E-07							
Lack of Fit	6.04E-06	3	2.01E-06	33.08	0.0028					
Pure Error	2.44E-07	4	6.09E-08							
Cor Total	0.0002	6								
Std. Dev.	0.0009	R-Squared			0.9664	df= degrees of freedom; SE= Standard Error				
Mean	0.0496	Adj R-Squared			0.9233	Coeff. Est = Coefficient of estimate				
C.V. %	1.91	Pred R-Squared			0.4818	CI = Confidence of Interval				
		Adeq Precision			16.9555	ns= non significance				

Table A13. Analysis of variance (ANOVA) for Grain elongation ratio of cooked rice in hot soaking

Source	Sum of Squares	df	Mean Sums of Square	F Value	p-value Prob > F	Coeff. Est.	df	SE	95% CI Low	95% CI High
Model	0.0535	9	0.0059	3.26	0.0665	1.45	1	0.0191	1.41	1.5
A-Soaking time	0.0048	1	0.0048	2.63	0.1487	0.0245	1	0.0151	-0.0112	0.0601
B-Steamig time	0.0124	1	0.0124	6.8	0.035	0.0394	1	0.0151	0.0037	0.075
C-Dryig temperature	0.0089	1	0.0089	4.87	0.0631	-0.0333	1	0.0151	-0.069	0.0024
AB	0.0072	1	0.0072	3.97	0.0867	0.0425	1	0.0213	-0.008	0.0929
AC	0.0003	1	0.0003	0.1707	0.6918	-0.0088	1	0.0213	-0.0593	0.0416
BC	1.55E-06	1	1.55E-06	0.0009	0.9775	-0.0006	1	0.0213	-0.0511	0.0498
A ²	0.0045	1	0.0045	2.46	0.1608	0.0326	1	0.0208	-0.0166	0.0818
B ²	0.0001	1	0.0001	0.0283	0.8711	-0.0035	1	0.0208	-0.0527	0.0457
C ²	0.0145	1	0.0145	7.97	0.0256	0.0587	1	0.0208	0.0095	0.1079
Residual	0.0127	7	0.0018							
Lack of Fit	0.0127	3	0.0042	657.7	< 0.0001					
Pure Error	0	4	6.45E-06							
Cor Total	0.0662	16								
Std. Dev.	0.0427	R-Squared			0.8076	df= degrees of freedom; SE= Standard Error				
Mean	1.49	Adj R-Squared			0.5602	Coeff. Est = Coefficient of estimate				
C.V. %	2.86	Pred R-Squared			-2.0728	CI = Confidence of Interval				
		Adeq Precision			5.689	ns= non significance				

Table A14. Analysis of variance (ANOVA) for hardness of cooked rice in hot soaking

Source	Sum of Squares	df	Mean Sums of Square	F Value	p-value Prob > F	Coeff. Est.	df	SE	95% CI Low	95% CI High
Model	46.96	9	5.22	116.67	< 0.0001	12.53	1	0.0946	12.31	12.75
A-Soaking time	1.15	1	1.15	25.66	0.0015	0.3788	1	0.0748	0.2019	0.5556
B-Steaming time	26.1	1	26.1	583.57	< 0.0001	1.81	1	0.0748	1.63	1.98
C-Dryig temperature	18.79	1	18.79	420.09	< 0.0001	1.53	1	0.0748	1.36	1.71
AB	0.0182	1	0.0182	0.4075	0.5436	0.0675	1	0.1057	-0.1825	0.3175
AC	0.0196	1	0.0196	0.4382	0.5292	-0.07	1	0.1057	-0.32	0.18
BC	0.1521	1	0.1521	3.4	0.1077	0.195	1	0.1057	-0.055	0.445
A ²	0.0671	1	0.0671	1.5	0.2602	0.1262	1	0.1031	-0.1175	0.37
B ²	0.0351	1	0.0351	0.7839	0.4053	0.0912	1	0.1031	-0.1525	0.335
C ²	0.5882	1	0.5882	13.15	0.0084	0.3738	1	0.1031	0.13	0.6175
Residual	0.3131	7	0.0447							
Lack of Fit	0.0589	3	0.0196	0.3088	0.8191					
Pure Error	0.2542	4	0.0635							
Cor Total	47.28	16								
Std. Dev.	0.2115	R-Squared		0.9934	df= degrees of freedom; SE= Standard Error					
Mean	12.81	Adj R-Squared		0.9849	Coeff. Est = Coefficient of estimate					
C.V. %	1.65	Pred R-Squared		0.9717	CI = Confidence of Interval					
		Adeq Precision		41.1683	ns= non significance					

Appendix B

Table B1 Effect of parboiling on milling efficiency and head rice yield in cold soaking

Treatments	Soaking time (h)	Steaming time (min)	Drying temperature (°C)	Milling efficiency (%)	Head Rice yield (%)
1	40	20	60	59.866	81.506
2	60	20	60	58.354	79.992
3	40	30	60	57.167	78.658
4	60	30	60	55.363	77.267
5	40	25	50	62.499	83.757
6	60	25	50	64.489	84.241
7	40	25	70	53.591	75.259
8	60	25	70	51.225	73.638
9	50	20	50	59.431	81.277
10	50	30	50	57.579	78.936
11	50	20	70	54.731	76.782
12	50	30	70	48.263	73.126
13	50	25	60	61.471	82.911
14	50	25	60	60.707	82.466
15	50	25	60	60.274	81.983
16	50	25	60	61.708	83.183
17	50	25	60	61.221	82.616

Table B2. Analysis of variance (ANOVA) for milling efficiency in cold soaking

Source	Sum of Squares	df	Mean Sums of Square	F Value	p-value Prob > F	Coeff. Est.	df	SE	95% CI Low	95% CI High
Model	287.36	9	31.93	18.13	0.0005	61.08	1	0.5935	59.67	62.48
A-Soaking time	2.19	1	2.19	1.24	0.3015	-0.5234	1	0.4692	-1.63	0.5861
B-Steaming time	24.53	1	24.53	13.93	0.0073	-1.75	1	0.4692	-2.86	-0.6416
C-Dryig temperature	168.2	1	168.2	95.49	< 0.0001	-4.59	1	0.4692	-5.69	-3.48
AB	0.0213	1	0.0213	0.0121	0.9156	-0.0729	1	0.6636	-1.64	1.5
AC	3.72	1	3.72	2.11	0.1893	-0.9648	1	0.6636	-2.53	0.6044
BC	5.33	1	5.33	3.03	0.1255	-1.15	1	0.6636	-2.72	0.4149
A ²	0.1041	1	0.1041	0.0591	0.8149	-0.1573	1	0.6468	-1.69	1.37
B ²	43.96	1	43.96	24.96	0.0016	-3.23	1	0.6468	-4.76	-1.7
C ²	34.06	1	34.06	19.34	0.0032	-2.84	1	0.6468	-4.37	-1.31
Residual	12.33	7	1.76							
Lack of Fit	10.97	3	3.66	10.78	0.0218					
Pure Error	1.36	4	0.3392							
Cor Total	299.69	16								
Std. Dev.	1.33	R-Squared		0.9589	df= degrees of freedom; SE= Standard Error					
Mean	58.14	Adj R-Squared		0.906	Coeff. Est = Coefficient of estimate					
C.V. %	2.28	Pred R-Squared		0.4071	CI = Confidence of Interval					
		Adeq Precision		15.3172	ns= non significance					

Table B3. Analysis of variance (ANOVA) for head rice yield in cold soaking

Source	Sum of Squares	Df	Mean Sums of Square	F Value	p-value Prob > F	Coeff. Est.	df	SE	95% CI Low	95% CI High
Model	191.17	9	21.24	13.62	0.0012	82.63	1	0.5584	81.31	83.95
A-Soaking time	2.04	1	2.04	1.31	0.2901	-0.5052	1	0.4415	-1.55	0.5387
B-Steamig time	16.74	1	16.74	10.73	0.0136	-1.45	1	0.4415	-2.49	-0.4025
C-Dryig temperature	108.09	1	108.09	69.32	< 0.0001	-3.68	1	0.4415	-4.72	-2.63
AB	0.0038	1	0.0038	0.0024	0.9622	0.0307	1	0.6243	-1.45	1.51
AC	1.11	1	1.11	0.7107	0.4271	-0.5263	1	0.6243	-2	0.95
BC	0.4315	1	0.4315	0.2767	0.6151	-0.3284	1	0.6243	-1.8	1.15
A ²	2.64	1	2.64	1.69	0.2346	-0.7914	1	0.6085	-2.23	0.6475
B ²	26	1	26	16.67	0.0047	-2.48	1	0.6085	-3.92	-1.05
C ²	28.83	1	28.83	18.49	0.0036	-2.62	1	0.6085	-4.06	-1.18
Residual	10.91	7	1.56							
Lack of Fit	10.08	3	3.36	16.19	0.0106					
Pure Error	0.8303	4	0.2076							
Cor Total	202.09	16								
Std. Dev.	1.25	R-Squared			0.946	df= degrees of freedom; SE= Standard Error				
Mean	79.86	Adj R-Squared			0.8766	Coeff. Est = Coefficient of estimate				
C.V. %	1.56	Pred R-Squared			0.1952	CI = Confidence of Interval				
		Adeq Precision			11.3196	ns= non significance				

Table B4. Effect of parboiling on qualities of milled rice in cold soaking

Treatments	Soaking time (h)	Steaming time (min)	Drying temperature (°C)	Hardness (N)	Chroma (B)	Bulk density (g/cm ³)	True density (g/cm ³)	Chalkiness
1	5	20	60	94.101	32.397	0.816	1.435	5
2	7	20	60	96.323	32.786	0.810	1.400	3
3	5	30	60	85.970	33.801	0.823	1.381	7
4	7	30	60	90.977	34.504	0.823	1.469	8
5	5	25	50	100.18	32.809	0.827	1.399	9
6	7	25	50	103.02	32.654	0.813	1.414	7
7	5	25	70	82.101	32.691	0.829	1.418	5
8	7	25	70	89.155	33.729	0.830	1.442	6
9	6	20	50	96.323	31.925	0.823	1.437	6
10	6	30	50	93.626	33.003	0.810	1.421	4
11	6	20	70	79.736	32.598	0.836	1.380	2
12	6	30	70	72.977	33.932	0.823	1.382	6
13	6	25	60	98.180	33.256	0.816	1.459	4
14	6	25	60	97.928	33.373	0.827	1.449	3
15	6	25	60	98.034	33.281	0.823	1.433	4
16	6	25	60	98.158	33.206	0.813	1.444	2
17	6	25	60	98.262	33.411	0.813	1.442	3

Table B5. Analysis of variance (ANOVA) for hardness of milled rice in cold soaking

Source	Sum of Squares	Df	Mean Sums of Square	F Value	p-value Prob > F	Coeff. Est.	df	SE	95% CI Low	95% CI High
Model	1062.69	9	118.08	127.71	<0.0001	98.13	1	0.43	97.11	99.15
A-Soaking time	36.64	1	36.64	39.63	0.0004	2.14	1	0.34	1.34	2.94
B-Steaming time	65.74	1	65.74	71.11	<0.0001	-2.87	1	0.34	-3.67	-2.06
C-Dryig temperature	598.2	1	598.2	647.01	<0.0001	-8.65	1	0.34	-9.45	-7.84
AB	1.94	1	1.94	2.1	0.1909	0.6962	1	0.4808	-0.4407	1.83
AC	4.44	1	4.44	4.8	0.0645	1.05	1	0.4808	-0.0831	2.19
BC	4.12	1	4.12	4.46	0.0726	-1.02	1	0.4808	-2.15	0.1214
A ²	2.91	1	2.91	3.14	0.1195	0.8308	1	0.4686	-0.2773	1.94
B ²	213.31	1	213.31	230.72	<0.0001	-7.12	1	0.4686	-8.23	-6.01
C ²	120.37	1	120.37	130.19	<0.0001	-5.35	1	0.4686	-6.45	-4.24
Residual	6.47	7	0.9246							
Lack of Fit	6.41	3	2.14	138.64	0.0002					
Pure Error	0.0617	4	0.0154							
Cor Total	1069.16	16								
Std. Dev.	0.9615	R-Squared			0.9939	df= degrees of freedom; SE= Standard Error				
Mean	92.66	Adj R-Squared			0.9862	Coeff. Est = Coefficient of estimate				
C.V. %	1.04	Pred R-Squared			0.904	CI = Confidence of Interval				
		Adeq Precision			40.9664	ns= non significance				

Table B6. Analysis of variance (ANOVA) for chroma of milled rice in cold soaking

Source	Sum of Squares	Df	Mean Sums of Square	F Value	p-value Prob > F	Coeff. Est.	df	SE	95% CI Low	95% CI High
Model	6.3	9	0.6999	32.89	< 0.0001	33.31	1	0.0652	33.15	33.46
A-Soaking time	0.4884	1	0.4884	22.95	0.002	0.2471	1	0.0516	0.1251	0.369
B-Steamig time	3.83	1	3.83	179.81	< 0.0001	0.6916	1	0.0516	0.5696	0.8135
C-Dryig temperature	0.8183	1	0.8183	38.46	0.0004	0.3198	1	0.0516	0.1979	0.4418
AB	0.0247	1	0.0247	1.16	0.3167	0.0786	1	0.0729	-0.0938	0.2511
AC	0.3557	1	0.3557	16.72	0.0046	0.2982	1	0.0729	0.1257	0.4707
BC	0.0163	1	0.0163	0.767	0.4102	0.0639	1	0.0729	-0.1086	0.2363
A ²	0.0313	1	0.0313	1.47	0.2646	0.0862	1	0.0711	-0.0819	0.2543
B ²	0.0017	1	0.0017	0.0822	0.7826	-0.0204	1	0.0711	-0.1885	0.1477
C ²	0.7458	1	0.7458	35.05	0.0006	-0.4209	1	0.0711	-0.589	-0.2528
Residual	0.149	7	0.0213							
Lack of Fit	0.1202	3	0.0401	5.58	0.0651					
Pure Error	0.0287	4	0.0072							
Cor Total	6.45	16								
Std. Dev.	0.1459	R-Squared			0.9769	df= degrees of freedom; SE= Standard Error				
Mean	33.14	Adj R-Squared			0.9472	Coeff. Est = Coefficient of estimate				
C.V. %	0.4402	Pred R-Squared			0.6947	CI = Confidence of Interval				
		Adeq Precision			22.0942	ns= non significance				

Table B7. Analysis of variance (ANOVA) for bulk density of milled rice in cold soaking

Source	Sum of Squares	Df	Mean Sums of Square	F Value	p-value Prob > F	Coeff. Est.	df	SE	95% CI Low	95% CI High
Model	0.0007	6	0.0001	3.78	0.8213	1	1	0.03	1.63	1.77
A-Soaking time	0.0001	1	0.0001	2.14	0.0028	1	1	0.02	0.51	0.62
B-Steamig time	7.90E-06	1	7.90E-06	0.2725	-0.001	1	1	0.02	0.06	0.18
C-Dryig temperature	2.39E-06	1	2.39E-06	0.0823	0.0005	1	1	0.02	0.11	0.22
AB	0	1	0	0.8643	-0.0025	1	1	0.03	0.02	0.18
AC	0.0001	1	0.0001	3.62	-0.0051	1	1	0.03	-0.11	0.04
BC	0.0005	1	0.0005	15.7	0.0107	1	1	0.03	-0.08	0.07
Residual	0.0003	10	0							
Lack of Fit	0.0001	6	0	0.6526	0.6955					
Pure Error	0.0001	4	0							
Cor Total	0.0009	16								
Std. Dev.	0.0054	R-Squared			0.6939	df= degrees of freedom; SE= Standard Error				
Mean	0.8213	Adj R-Squared			0.5103	Coeff. Est = Coefficient of estimate				
C.V. %	0.6556	Pred R-Squared			0.0944	CI = Confidence of Interval				
		Adeq Precision			6.7491	ns= non significance				

Table B8. Analysis of variance (ANOVA) for True density of milled rice in cold soaking

Source	Sum of Squares	Df	Mean Sums of Square	F Value	p-value Prob > F	Coeff. Est.	df	SE	95% CI Low	95% CI High
Model	0.0092	9	0.001	2.37	0.1344	1.45	1	0.0093	1.42	1.47
A-Soaking time	0.001	1	0.001	2.43	0.1632	0.0115	1	0.0074	-0.0059	0.0288
B-Steamig time	6.52E-08	1	6.52E-08	0.0002	0.9905	0.0001	1	0.0074	-0.0173	0.0175
C-Dryig temperature	0.0003	1	0.0003	0.6949	0.432	-0.0061	1	0.0074	-0.0235	0.0113
AB	0.0038	1	0.0038	8.88	0.0205	0.031	1	0.0104	0.0064	0.0556
AC	0	1	0	0.055	0.8214	0.0024	1	0.0104	-0.0221	0.027
BC	0.0001	1	0.0001	0.1892	0.6767	0.0045	1	0.0104	-0.0201	0.0291
A ²	0.0001	1	0.0001	0.2971	0.6026	-0.0055	1	0.0101	-0.0295	0.0184
B ²	0.0015	1	0.0015	3.42	0.1069	-0.0187	1	0.0101	-0.0427	0.0052
C ²	0.002	1	0.002	4.6	0.069	-0.0217	1	0.0101	-0.0457	0.0022
Residual	0.003	7	0.0004							
Lack of Fit	0.0027	3	0.0009	9.98	0.025					
Pure Error	0.0004	4	0.0001							
Cor Total	0.0122	16								
Std. Dev.	0.0208	R-Squared		0.7527	df= degrees of freedom; SE= Standard Error					
Mean	1.42	Adj R-Squared		0.4347	Coeff. Est = Coefficient of estimate					
C.V. %	1.46	Pred R-Squared		-2.5363	CI = Confidence of Interval					
		Adeq Precision		5.3216	ns= non significance					

Table B9. Effect of parboiling on qualities of cooked rice in cold soaking

Treatments	Soaking time (h)	Steaming time (min)	Drying temperature (°C)	Cooking time (min)	Water uptake ratio	Hardness (N)	Grain elongation ratio	Gruel solid loss (g/g)
1	5	20	60	19:41	1.658	13.62	1.6435	0.0633
2	7	20	60	20:08	1.760	14.29	1.7138	0.0710
3	5	30	60	20:26	1.779	17.21	1.6341	0.0306
4	7	30	60	23:12	2.207	17.86	1.4638	0.0435
5	5	25	50	23:13	1.757	14.44	1.5317	0.0627
6	7	25	50	23:50	1.944	14.61	1.6249	0.0409
7	5	25	70	23:23	1.945	16.95	1.4355	0.0603
8	7	25	70	23:37	1.955	17.21	1.3855	0.0587
9	6	20	50	22:08	1.754	12.95	1.4661	0.0673
10	6	30	50	25:45	2.619	16.14	1.5316	0.0248
11	6	20	70	22:52	1.686	14.59	1.6213	0.0606
12	6	30	70	24:13	2.269	18.43	1.4254	0.0474
13	6	25	60	22:47	2.161	15.23	1.4896	0.0569
14	6	25	60	22:33	2.161	15.52	1.4886	0.0558
15	6	25	60	22:58	2.160	15.49	1.4891	0.0565
16	6	25	60	21:55	2.161	15.23	1.4889	0.0568
17	6	25	60	22:32	2.160	15.48	1.4885	0.0559

Table B10 Analysis of variance (ANOVA) for cooking time of cooked rice in cold soaking

Source	Sum of Squares	df	Mean Sums of Square	F Value	p-value Prob > F	Coeff. Est.	Df	SE	95% CI Low	95% CI High	VIF
Model	1.28E+05	9	14189.64	9.04	0.0042	1353	1	17.72	1311.11	1394.89	1353
A-Soaking time	7442	1	7442	4.74	0.0659	30.5	1	14.01	-2.62	63.62	30.5
B-Steaming time	49141.13	1	49141.13	31.32	0.0008	78.38	1	14.01	45.26	111.49	78.38
C-Dryig temperature	2850.13	1	2850.13	1.82	0.2197	-18.88	1	14.01	-51.99	14.24	-18.88
AB	4830.25	1	4830.25	3.08	0.1228	34.75	1	19.81	-12.09	81.59	34.75
AC	132.25	1	132.25	0.0843	0.78	-5.75	1	19.81	-52.59	41.09	-5.75
BC	324	1	324	0.2065	0.6633	-9	1	19.81	-55.84	37.84	-9
A ²	8526.32	1	8526.32	5.43	0.0525	-45	1	19.31	-90.65	0.6499	-45
B ²	13322.37	1	13322.37	8.49	0.0225	-56.25	1	19.31	-101.9	-10.6	-56.25
C ²	44452.89	1	44452.89	28.33	0.0011	102.75	1	19.31	57.1	148.4	102.75
Residual	10984.75	7	1569.25								
Lack of Fit	8718.75	3	2906.25	5.13	0.0741						
Pure Error	2266	4	566.5								
Cor Total	1.39E+05	16									
Std. Dev.	39.61	R-Squared			0.9208	df= degrees of freedom; SE= Standard Error					
Mean	1353.71	Adj R-Squared			0.819	Coeff. Est = Coefficient of estimate					
C.V. %	2.93	Pred R-Squared			-0.0314	CI = Confidence of Interval					
		Adeq Precision			11.0796	ns= non significance					

Table B11. Analysis of variance (ANOVA) for WAR of cooked rice in cold soaking

Source	Sum of Squares	df	Mean Sums of Square	F Value	p-value Prob > F	Coeff. Est.	df	SE	95% CI Low	95% CI High
Model	0.9172	9	0.1019	4.5	0.03	2.16	1	0.0673	2	2.32
A-Soaking time	0.066	1	0.066	2.92	0.1314	0.0908	1	0.0532	-0.0349	0.2166
B-Steamig time	0.508	1	0.508	22.44	0.0021	0.252	1	0.0532	0.1262	0.3778
C-Dryig temperature	0.0059	1	0.0059	0.2622	0.6244	0.0272	1	0.0532	-0.153	0.0985
AB	0.0267	1	0.0267	1.18	0.3133	0.0817	1	0.0752	-0.0962	0.2596
AC	0.0078	1	0.0078	0.3451	0.5754	-0.0442	1	0.0752	-0.2221	0.1337
BC	0.0199	1	0.0199	0.8802	0.3794	-0.0706	1	0.0752	-0.2485	0.1073
A ²	0.2537	1	0.2537	11.21	0.0123	-0.2455	1	0.0733	-0.4188	-0.0721
B ²	0.017	1	0.017	0.7532	0.4142	-0.0636	1	0.0733	-0.237	0.1097
C ²	0.0009	1	0.0009	0.0403	0.8466	-0.0147	1	0.0733	-0.1881	0.1587
Residual	0.1584	7	0.0226							
Lack of Fit	0.1584	3	0.0528	1.81E+05	<	0.0001				
Pure Error	1.17E-06	4	2.92E-07							
Cor Total	1.08	16								
Std. Dev.	0.1504	R-Squared			0.8527	df= degrees of freedom; SE= Standard Error				
Mean	2.01	Adj R-Squared			0.6633	Coeff. Est = Coefficient of estimate				
C.V. %	7.49	Pred R-Squared			-1.3569	CI = Confidence of Interval				
		Adeq Precision			7.2942	ns= non significance				

Table B12. Analysis of variance (ANOVA) for gruel solid loss of cooked rice in cold soaking

Source	Sum of Squares	Df	Mean Sums of Square	F Value	p-value Prob > F	Coeff. Est.	df	SE	95% CI Low	95% CI High
Model	0.0022	9	0.0002	7.14	0.0084	0.0564	1	0.0026	0.0501	0.0626
A-Soaking time	9.36E-07	1	9.36E-07	0.0268	0.8746	-0.0003	1	0.0021	-0.0053	0.0046
B-Steamig time	0.0017	1	0.0017	48.14	0.0002	-0.0145	1	0.0021	-0.0194	0.0096
C-Dryig temperature	0.0001	1	0.0001	3.55	0.1016	0.0039	1	0.0021	-0.001	0.0089
AB	6.86E-06	1	6.86E-06	0.1963	0.6711	0.0013	1	0.003	-0.0057	0.0083
AC	0.0001	1	0.0001	2.95	0.1299	0.0051	1	0.003	-0.0019	0.0121
BC	0.0002	1	0.0002	6.17	0.042	0.0073	1	0.003	0.0004	0.0143
A ²	1.99E-06	1	1.99E-06	0.057	0.8182	0.0007	1	0.0029	-0.0061	0.0075
B ²	0.0001	1	0.0001	2.9	0.1321	-0.0049	1	0.0029	-0.0117	0.0019
C ²	8.22E-06	1	8.22E-06	0.2352	0.6425	-0.0014	1	0.0029	-0.0082	0.0054
Residual	0.0002	7	0							
Lack of Fit	0.0002	3	0.0001	315.72	< 0.0001					
Pure Error	1.03E-06	4	2.57E-07							
Cor Total	0.0025	11								
Std. Dev.	0.0059		R-Squared		0.9018	df= degrees of freedom; SE= Standard Error				
Mean	0.0537		Adj R-Squared		0.7755	Coeff. Est = Coefficient of estimate				
C.V. %	11		Pred R-Squared		-0.5655	CI = Confidence of Interval				
			Adeq Precision		9.7081	ns= non significance				

Table B13. Analysis of variance (ANOVA) for Grain elongation ratio of cooked rice in cold soaking

Source	Sum of Squares	df	Mean Sums of Square	F Value	p-value Prob > F	Coeff. Est.	df	SE	95% CI Low	95% CI High
Model	0.1089	9	0.0121	3.66	0.0505	1.49	1	0.0257	1.43	1.55
A-Soaking time	0.0004	1	0.0004	0.1214	0.7378	-0.0071	1	0.0203	-0.0551	0.041
B-Steaming time	0.019	1	0.019	5.75	0.0476	-0.0487	1	0.0203	-0.0968	-0.0007
C-Dryig temperature	0.0103	1	0.0103	3.11	0.1213	-0.0358	1	0.0203	-0.0839	0.0122
AB	0.0145	1	0.0145	4.38	0.0747	-0.0601	1	0.0287	-0.1281	0.0078
AC	0.0051	1	0.0051	1.55	0.2528	-0.0358	1	0.0287	-0.1038	0.0321
BC	0.0171	1	0.0171	5.17	0.0572	-0.0654	1	0.0287	-0.1333	0.0026
A ²	0.0123	1	0.0123	3.73	0.0948	0.0541	1	0.028	-0.0122	0.1203
B ²	0.0211	1	0.0211	6.39	0.0394	0.0708	1	0.028	0.0045	0.137
C ²	0.0099	1	0.0099	3.01	0.1264	-0.0486	1	0.028	-0.1148	0.0177
Residual	0.0231	7	0.0033							
Lack of Fit	0.0231	3	0.0077	35488.79	< 0.0001					
Pure Error	8.69E-07	4	2.17E-07							
Cor Total	0.1321	16								
Std. Dev.	0.0575	R-Squared			0.8248	df= degrees of freedom; SE= Standard Error				
Mean	1.52	Adj R-Squared			0.5996	Coeff. Est = Coefficient of estimate				
C.V. %	3.77	Pred R-Squared			-1.8027	CI = Confidence of Interval				
		Adeq Precision			8.0383	ns= non significance				

Table B14. Analysis of variance (ANOVA) for hardness of cooked rice in cold soaking

Source	Sum of Squares	df	Mean Sums of Square	F Value	p-value Prob > F	Coeff. Est.	df	SE	95% CI Low	95% CI High
Model	36.36	9	4.04	78.27	< 0.0001	15.39	1	0.1016	15.15	15.63
A-Soaking time	0.3828	1	0.3828	7.42	0.0296	0.2188	1	0.0803	0.0288	0.4087
B-Steamig time	25.17	1	25.17	487.55	< 0.0001	1.77	1	0.0803	1.58	1.96
C-Dryig temperature	10.22	1	10.22	197.87	< 0.0001	1.13	1	0.0803	0.94	1.32
AB	0.0001	1	0.0001	0.0019	0.9661	-0.005	1	0.1136	-0.2736	0.2636
AC	0.002	1	0.002	0.0392	0.8486	0.0225	1	0.1136	-0.2461	0.2911
BC	0.1056	1	0.1056	2.05	0.1957	0.1625	1	0.1136	-0.1061	0.4311
A ²	0.4178	1	0.4178	8.09	0.0249	0.315	1	0.1107	0.0532	0.5768
B ²	0.0067	1	0.0067	0.1305	0.7286	0.04	1	0.1107	-0.2218	0.3018
C ²	0.04	1	0.04	0.7753	0.4078	15.39	1	0.1016	15.15	15.63
Residual	0.3614	7	0.0516							
Lack of Fit	0.2752	3	0.0917	4.26	0.0978					
Pure Error	0.0862	4	0.0215							
Cor Total	36.73	16								
Std. Dev.	0.2272	R-Squared		0.9902	df= degrees of freedom; SE= Standard Error					
Mean	15.6	Adj R-Squared		0.9775	Coeff. Est = Coefficient of estimate					
C.V. %	1.46	Pred R-Squared		0.8765	CI = Confidence of Interval					
		Adeq Precision		33.326	ns= non significance					

Appendix C

Table C1. Response optimization constraints of hot soaking

Sl. No.	Parameters	Goal	Lower limit	Upper limit
1	Soaking time (h)	in range	5	7
2	Steaming time (min)	in range	20	30
3	Drying temperature (°C)	in range	50	70
4	Milling efficiency (%)	maximise	49.0163	66.7154
5	Head rice yield (%)	maximise	71.6755	88.677
6	Chroma	minimize	32.0431	35.0718
7	Bulk density (g/cm ³)	in range	0.793651	0.865817
8	True density (g/cm ³)	in range	1.37115	1.46541
9	Hardness (N)	maximize	70.4721	90.3381
10	Cooking time (s)	in range	1243	1492
11	WAR	in range	1.6398	2.4349
12	Gruel solid loss (g/g)	minimize	0.004469	0.0558
13	Grain elongation ratio	in range	1.42756	1.61963
14	Hardness of cooked rice (N)	maximise	9.95	16.43

Table C2. Response optimization constraints of cold soaking

Sl. No.	Parameters	Goal	Lower limit	Upper limit
1	Soaking time (h)	in range	40	60
2	Steaming time (min)	in range	20	30
3	Drying temperature (°C)	in range	50	70
4	Milling efficiency (%)	maximise	48.2637	64.4892
5	Head rice yield (%)	maximise	73.1268	84.2414
6	Chroma	minimize	31.9253	34.504
7	Bulk density (g/cm ³)	in range	0.810526	0.836503
8	True density (g/cm ³)	in range	1.38042	1.46934
9	Hardness (N)	maximize	72.977	103.019
10	Cooking time (s)	in range	1181	1545
11	WAR	in range	1.6585	2.619
12	Gruel solid loss (g/g)	minimize	0.0248	0.07105
13	Grain elongation ratio	in range	1.38554	1.7139
14	Hardness of cooked rice (N)	maximise	12.95	18.43

Appendix D

Cost Economics of developed parboiling cum drying unit

Cost of machineries		
Cost of developed parboiling cum drying unit	=	Rs. 95000/-
Building cost (100 m ²)	=	Rs. 200000/-
Miscellaneous item	=	Rs. 20000/-
Total Cost	=	Rs. 3,15,000/-

Assumptions

Life span (L)	=	10 years
Annual working hours (H)	=	275 days (per day 8 hrs) = 2200 hours
Salvage value (S)	=	10% of initial cost
Interest on initial cost (i)	=	15% annually
Repair and maintenance	=	8% of initial cost
Insurance and taxes	=	2% of initial cost
Electricity charge	=	Rs.7/unit
Labour wages/person	=	Rs. 350/day

1. Total Fixed cost per day		
i. Depreciation	=	$\frac{C-S}{L \times H} = \frac{3,15,000-31,500}{10 \times 2200} =$ Rs. 12.88/h
ii. Interest	=	$\frac{C+S}{2} \times \frac{i}{H} = \frac{3,15,000+31,500}{2} \times \frac{15}{100 \times 2200}$ =Rs.11.81/h
iii. Insurance & taxes	=	2% of initial cost

		$=\frac{2}{100 \times 2200} \times 3,15,000 = \text{Rs. } 2.86/\text{h}$
Total Fixed cost	=	i + ii + iii = Rs. 27.55/h = Rs. 220.4/day
2. Total variable cost per day		
i. Repair & maintenance	=	8% of initial cost $=\frac{8}{100 \times 2200} \times 3,15,000$ =11.45/h
ii. Electricity cost a). Energy consumed by LSU dryer b). Cost of energy consumption/day	=	1.1 kwh = Power x duration x cost of one unit =1.1 x 8 x 7 = Rs. 61.6/ day
iii. Cost of fire wood a). Amount of fire wood needed b). Cost of Fire wood/ kg c). Total cost of firewood	=	50 kg/ day = Rs. 2/kg = 100/day
iv. Labour cost (1 person) (Inclusive of soaking, steaming and drying process)	=	Rs. 600/ day
v. Packaging cost	=	Rs. 30/day
Total variable cost	=	i + ii + iii + iv + v =Rs. 803.05/-
Therefore total cost for production of 400 kg of parboiled paddy/ day	=	Fixed cost + Variable cost = 220.4+ 803.05 = Rs. 1,023.45/day
Processing cost of 1 kg of parboiled paddy	=	Rs. 2.5/kg
Cost of milling 1 kg of parboiled paddy	=	Rs. 2/kg
Total processing cost of paddy	=	Rs. 4.5/ kg

Processing cost of parboiling and milling the paddy in rice mills = Rs.6/kg

$$\text{Benefit-cost ratio} = \frac{6}{4.5} = 1.33$$

Therefore the total processing cost of 1 kg of parboiled paddy in the parboiling cum drying unit was found to be Rs. 2.5. The benefit cost ratio was found to be 1.33:1

**DEVELOPMENT OF SMALL SCALE PARBOILING CUM
DRYING UNIT FOR PADDY PROCESSING**

by

ANN ANNIE SHAJU

(2018-18-022)

ABSTRACT OF THE THESIS

Submitted in partial fulfilment of the requirement for the degree of

MASTER OF TECHNOLOGY

IN

AGRICULTURAL ENGINEERING

(Agricultural Processing and Food Engineering)

Faculty of Agricultural Engineering & Technology

Kerala Agricultural University



**DEPARTMENT OF PROCESSING AND FOOD ENGINEERING
KELAPPAJI COLLEGE OF AGRICULTURAL ENGINEERING AND
TECHNOLOGY**

TAVANUR - 679573, MALAPPURAM

KERALA, INDIA

2020

Abstract

Parboiling is an optional unit operation in paddy processing, which results in enhanced milling efficiency with improved nutritional quality of the rice. It is accomplished through the process of soaking, steaming and drying, to gelatinize the starch. Technological advancement in the industrial parboiling has resulted in extensive improvisation of process controls in large-scale industrial parboiling units. But enormous initial investments required for infrastructure, along with the time, labour and energy involved in paddy parboiling made it uneconomical for small scale milling and processing units to undertake parboiling. In this scenario, a small scale parboiling cum drying unit with reduced drudgery and less human interventions was fabricated in this present study for paddy processing and its evaluation was done. The unit mainly consists of two soaking cum steaming chambers (100 kg/tank), LSU dryer, bucket elevator, steam boiler and heat furnace. Soaking and steaming was carried out in the same chamber and drying was carried out in the LSU dryer. The paddy crop variety *Jyothi* was parboiled at different soaking and steaming times (20, 25 and 30 min) and drying temperatures (50, 60 and 70°C) in both hot soaking and cold soaking methods. The performance evaluation of the developed unit was done by analysing the milling and cooking qualities of the parboiled paddy. The treatments were optimised using the Response Surface Methodology (Box Behnken) method. An increase in steaming time exerted a significant effect on milling and cooking qualities of parboiled paddy. The increase in drying time decreased the milling efficiency, head rice yield and hardness of the parboiled milled rice. After optimisation, for hot soaking, milling efficiency of 65.43% and head rice yield of 87.78% were obtained with a soaking time of 7 h, steaming time of 26.07 min and drying temperature of 52°C. In case of cold soaking, milling efficiency of 62.15% and head rice yield of 81.93% were obtained with a soaking time of 60 h, steaming time of 27 min and drying temperature of 52°C. The processing cost of parboiling one-kilogram paddy in the developed unit were Rs. 2.55/-. The benefit cost ratio for the parboiling process was found to be 1.33:1, which revealed that the developed unit was economically feasible.