

**INVESTIGATIONS ON CLAMPING AND CLIMBING
MECHANISMS FOR THE DESIGN OF SEMI AUTONOMOUS
ARECA PALM CLIMBER**

by
SUPRITHA



KERALA AGRICULTURAL UNIVERSITY
Department of Farm Power Machinery and Energy
**KELAPPAJI COLLEGE OF AGRICULTURAL ENGINEERING AND
TECHNOLOGY**
TAVANUR, MALAPPURAM- 679 573
KERALA, INDIA
2017

**INVESTIGATIONS ON CLAMPING AND CLIMBING
MECHANISMS FOR THE DESIGN OF SEMI AUTONOMOUS
ARECA PALM CLIMBER**

by
SUPRITHA
(2015-18-010)

THESIS

Submitted in partial fulfilment of the requirement for the degree of
MASTERS OF TECHNOLOGY

IN

AGRICULTURAL ENGINEERING

(Farm Power, Machinery and Energy)

Faculty of Agricultural Engineering and Technology

Kerala Agricultural University



Department of Farm Power Machinery and Energy

**KELAPPAJI COLLEGE OF AGRICULTURAL ENGINEERING AND
TECHNOLOGY**

TAVANUR, MALAPPURAM- 679 573

KERALA, INDIA

2017

DECLARATION

I, hereby declare that this thesis entitled **“INVESTIGATIONS ON CLAMPING AND CLIMBING MECHANISMS FOR THE DESIGN OF SEMI AUTONOMOUS ARECA PALM CLIMBER”** is a bonafide record of research work done by me during the course of research and the thesis has not previously formed the basis for the award to me of any degree, diploma, associateship, fellowship or other similar title, of any other university or society.

Place: Tavanur

Date:

Supritha

(2015-18-010)

CERTIFICATE

Certified that this thesis entitled “**INVESTIGATIONS ON CLAMPING AND CLIMBING MECHANISMS FOR THE DESIGN OF SEMI AUTONOMOUS ARECA PALM CLIMBER**” is a record of research work done independently by **Ms. Supritha (2015- 18-010)** under my guidance and supervision and that it has not previously formed the basis for the award of any degree, diploma, fellowship, associate ship to her.

Tavanur,

Date:

Er. Shivaji K.P

(Major Advisor, Advisory Committee)

Assistant Professor

Department of Farm Power Machinery

and Energy,

KCAET, KAU,

Tavanur, Kerala

CERTIFICATE

We, the undersigned members of the advisory committee of Ms. Supritha (2015-18-010), a candidate for the degree of Master of Technology in Agricultural Engineering major in Farm Power Machinery and Energy, agree that the thesis entitled **“INVESTIGATIONS ON CLAMPING AND CLIMBING MECHANISMS FOR THE DESIGN OF SEMI-AUTONOMOUS ARECA PALM CLIMBER”** may be submitted by Ms. Supritha, in partial fulfilment of the requirement for the degree.

Er. Shivaji, K. P

(Chairman, Advisory Committee)

Assistant Professor

Department of FPME

KCAET, Tavanur

Dr. Jayan, P. R

(Member, Advisory Committee)

Professor & Head,

Department of FPME

KCAET, Tavanur

Dr. Shaji James. P

(Member, Advisory Committee)

Associate professor

Department of FPME

KCAET, Tavanur

Er. Priya G Nair

(Member, Advisory Committee)

Assistant Professor

Department of LWRCE

KCAET, Tavanur

EXTERNAL EXAMINER

(Name and Address)

ACKNOWLEDGEMENT

Every effort in this world comes to its fruitful culmination not because of sincere work of one but only due to the combined support and endeavour of many.

*I would like to give my first thanks to almighty **God** and my **Parents** as without their mercy, accomplishment of my work and preparation of this manuscript would have not been possible.*

*I express my deep and sincere regards, profound sense of gratitude and indebtedness to **Er. Shivaji, K.P.**, Assistant Professor and Chairman of my Advisory Committee, Department of Farm Power Machinery and Energy, K.C.A.E.T, Tavanur for untiring supervision, meticulous guidance and benevolent criticisms during the entire course of this investigation. It is my proud privilege to express my heartfelt indebtedness and deepest sense of gratitude for laying out the guidelines of research work. I have real admiration and regards for his full hearted support and untiring help.*

*It is my pleasure to pay tribute to **Dr. Shanthi Merry Mathew Dean**, and **Dr. M.S. Hajilal**, former dean K.C.A.E.T, Tavanur, for his advice and guidance rendered during this study.*

*My sincere thanks goes to **Dr. Jayan, P.R.**, Professor & Head, Department of Farm Power Machinery and Energy, KCAET, Tavanur, **Dr. Shaji James, P.**, Professor, Department of Farm Power Machinery and Energy, KCAET, Tavanur, **Er. Priya G Nair**, Assistant Professor, Department of LWRCE, KCAET, Tavanur as members of advisory committee. I am indebted to them for their encouragement and support in my research.*

It gives me immense pleasure to express my deep sense of gratitude and indebtedness to all the teachers, Department of Farm Power Machinery and Energy, K.C.A.E.T, Tavanur, for their valuable guidance, profound suggestions and constant encouragement and advice throughout the project work.

*It is my pleasure to offer whole hearted thanks to Ph.D. scholars **Er. Sankalpa, K.B. and Er. Deepak** for their valuable suggestions, constant encouragement and moral support shown throughout my study.*

*I shall never forget the enormous and timely help rendered **Mr. Sudheer, Mr. Srikanth, Mr. Hari Krishna, Mr. Manu, Mr. Lenin, Mr. Vipin, Mr. Rajesh, Mr. Praveen, Mr. prasoon, Mr. surjith, Mr. Hari (CAD expert)** and all other technicians, cannot be captured in words for their co-operation and assistance during the course of my research work.*

*Above all, my success would have remained an illusion without the ambitious encouragement, unquantifiable love, continued calm endurance, constant support and affection showered on me throughout the educational endeavour from my beloved parents **Smt. Lakshmi and Sri. Ramesh**. I have been highly fortunate and lucky to express my heartfelt respect to my dearest family members **Jogigowda, Sharadha, Kempamma, Punith, Revanna, A. R., Sushma, Channamma, Narasimhegowda, Basavegowda, Vasanta, Yoganarasimhegowda, Deepak, Rekha, Shashank, Karthik** and my relatives for their kind blessings and well wishes showed on me.*

*I use this opportunity to sincerely thank my dearest classmates **Pooja, Gayathri, Srinivas, Naveen, Athul chandran, Nidin, Saikrishna, Pravalika, Anupama, Madhavi, Tejaswini, Ardra, Cloudia, and Sreekutty** for their suggestion and invaluable help during my study.*

*Words could not help me when I need to thank my dear friends, seniors and juniors, **Venkatareddy, Chethan, Ramya, R., Pooja, M.R., and Pooja, V.** for the great support they gave me.*

*I express my thanks to all the faculty **members of Library, KCAET, Tavanur** for their ever willing help and co-operation. I express my sincere thanks and gratitude to **Kelappaji College of Agricultural Engineering & Technology** for giving me an opportunity to undergo my P.G studies and **Kerala Agricultural University** for having proffered me a chance to study in this institution.*

One last word; since it is practically impossible to list all the names who have contributed to my work, it seems proper to issue a blanket of thanks for those who helped me directly or indirectly during the course of study.

..... any omission in this small manuscript does not mean lack of gratitude.

Supritha

Dedicated to
My beloved parents
Smt. Lakshmi
Sri. Ramesh

CONTENTS

Chapter No.	Title	Page No.
	LIST OF TABLES	i
	LIST OF FIGURES	ii
	LIST OF PLATES	iv
	SYMBOLS AND ABBREVIATIONS	v
1	INTRODUCTION	1
2	REVIEW OF LITERATURE	5
3	MATERIALS AND METHODS	23
4	RESULTS AND DISCUSSION	43
5	SUMMARY AND CONCLUSION	73
6	REFERENCES	78
7	APPENDICES	
8	ABSTRACT	

LIST OF TABLES

Table No.	Title	Page No.
4.1	Mechanisms used in the mechanical palm climber	48
4.2	Mechanisms used in the robotic palm climbers	51
4.3	Comparison of mechanical and robotic palm climbers	52
4.4	Measures of central tendency and dispersion	54
4.5	Measured and estimated diameter of areca palm	55
4.6	Maximum and minimum deviation	56
4.7	R^2 values for linear curves	60
4.8	Height of areca palm	61
4.9	Height and diameter of areca palm	62
4.10	Tilt angle of areca palm	63
4.11	Mechanisms and parameters of developed prototypes	64
4.12	Specifications of the screw rod	68
4.13	Specifications of the gears	68
4.14	Specifications of the motor	69
4.15	Specifications of Prototype 2	72

LIST OF FIGURES

Figure No.	Title	Page No.
3.1	Measurements to obtain tree height	28
3.2	Measurements of tilt to the palm	30
3.3	Top view of gripping unit	36
3.4	Isometric view of gripping unit	37
3.5	Isometric view of climber	38
4.1	Classifications of palm climbers	45
4.2	Different mechanisms involved in discrete motion	50
4.3	Distribution of measured and estimated diameters	54
4.4	Measured and Estimated diameter of areca palm	56
4.5	Difference between maximum and minimum deviations	57
4.6	Deviation of palm at bottom 5 m and above 4 m	57
4.7	Variation of diameter v/s height	59
4.8	Height of areca palm	61
4.9	Height and diameter of areca palm	62
4.10	Tilt angle of areca palm	63
4.11	Top view of gripping unit	65

4.12	Front view of gripping unit	66
4.13	Side view of gripping unit	66
4.14	Three dimensional view of climbing unit with gripping units	67
4.15	Process of palm climbing	71

LIST OF PLATES

Plate No.	Title	Page No.
3.1	Measurement of diameter of areca palm using vernier caliper	26
3.2	Measurement of circumference of areca palm using thread	26
3.3	Sprit level app focuses the top of the tree	28
3.4	Equipment used to measure tilt	29
3.5	Clamping or Gripping unit	36
3.6	Climbing unit	38
3.7	Control board	39
3.8	Testing of fabricated prototype 1 in the lab set up	41
3.9	Testing of fabricated prototype 2 in the lab set up	42

SYMBOLS AND ABBREVIATIONS

<i>et al.</i>	:	And others
cm	:	Centimetre
⁰ C	:	Degree centigrade
dia.	:	Diameter
DC	:	Direct current
÷	:	Divide
etc.	:	Etcetera
=	:	Equal to
e.g.	:	Example
Fig.	:	Figure
g	:	Gram
ha	:	Hectares
KCAET	:	Kelappaji College of Agricultural Engineering and Technology
kg	:	Kilogram
max	:	Maximum
m	:	Meters
min	:	Minute
min	:	Minimum
mm	:	Millimetre
MT	:	Million Tonnes
×	:	Multiply
No.	:	Number
/	:	Per
%	:	Per cent
rpm	:	Revolutions per minute
s	:	Second
V	:	Volts

CHAPTER I

INTRODUCTION

Palm is an un-branched evergreen tree of tropical and warm regions, with a crown of very long feather or fan-shaped leaves and typically having old leaf scars forming a regular pattern on the trunk. There are more than 2,500 species of palm trees found in the world and most of the palms belong to the *Arecaceae* family (Christenhusz and Byng, 2016). These evergreen plants can grow in the form of shrubs, trees or woody vines called lianas. Palms are mainly cultivated for its nuts and a wide variety of products are made from the nuts, oil being the major one. Coconut, date palm, oil palm, arecanut are some of the common types of commercially cultivated palms.

The people in rural areas of Karnataka and Kerala mainly depend on agriculture for their livelihood and main crops grown are arecanut and coconut (Basavaraja *et al.*, 2015). An arecanut palm, (*Areca catechu L.*) is the source of the common masticatory nut, popularly known as betel nut or supari. Arecanut is grown in India, China, Bangladesh, Myanmar, Thailand, Malaysia, Indonesia, Philippines, and Srilanka. India ranks first in arecanut production in the world (Ramappa, 2013). In 2014, the area under arecanut was around 4,51,900 ha with a production of about 6,22,270 MT in India (Agricultural Statistics, 2014).

The major arecanut growing states in India are Karnataka, Kerala and Assam. Nearly 95 per cent of the arecanut area is accounted by these three principal area growing states. It is also cultivated to a small extent in Tamil Nadu, West Bengal, Maharashtra, Andra Pradesh, Meghalaya, Goa, Tripura, Puducherry, Mizoram, Andaman and Nicobar Islands. Karnataka stands first both in terms of area and production followed by Kerala and Assam (Ramappa, 2013). Karnataka has a production of 4,57,560 MT from an area of 2,18,010 ha (Agricultural Statistics, 2014). Kerala occupies 96,686 ha of area under cultivation of arecanut and a production of 1,25,926 MT during the year 2014-15. It contributes of about 22 percent area and 16 percent production in the cultivation of arecanut in the

country. The two leading districts in production of arecanut in Kerala are Kasaragod (41%) and Malappuram (18%) (Anon, 2016). Being a high valued commercial crop, its contribution in terms of livelihood, employment and income to the national economy is significant.

The areca palms normally have small diameters ranges from 10-15 cm and they grow up to a height of 8-12 m (Veeresh *et al.*, 2016). It takes approximately five years for an arecanut palm to mature and bear fruit. Once mature, the palm can provide nuts annually for up to fifty years. Each areca palm is harvested once a year, which limits the areca farmer's ability to change crop mix as the relative prices of crops change. The areca nut is considered to be a cash crop and there are thousands of households in the state of Karnataka that depend entirely on the income from their areca plantation (Hegde *et al.*, 2014). One of the main threats to this industry is the increasing cost of production and the decrease in the labor resource, especially for harvesting.

All the operations like harvesting of nuts and spraying pesticides need to be done in the crown, which requires laborers to climb up the tree. Although such a process looks easy, in reality it is a dangerous and laborious work. Moreover, only trained laborers can perform this work. In order to make this job easy, mechanical aids like ladders were used in certain regions. Different types of mechanical man positioners that take the operator to the crown of palm are also being used. They are not completely successful, as it requires a person to climb the tree and the input is mainly muscular power of operator.

On reviewing the designs of mechanical palm climbers, it is learnt that all the climbers essentially comprises of two functional mechanisms, one for gripping and releasing the unit to the trunk, which can be termed as clamping or gripping mechanism and the other for facilitating vertical movement of the unit which can be termed as climbing mechanism. Most of these designs consist of two sets of functional components which can be moved relative to one another. Both of the functional components will have clamping provisions, the common ones being

steel ropes or metallic clamps. The lower set is first clamped to the trunk of tree and the upper set is raised along the trunk and clamped. Once the upper set is clamped to the trunk, the lower set is unclamped from the truck, raised and then clamped. Repeating the operations facilitates the vertical movement of the unit.

Researchers all around the world has been working on climbing robots and most of climbing robots are capable of climbing regular structures like poles, walls, domes etc. Only a very few number of robots are capable of climbing trees, the main reason being irregular surface and variation of diameter along the length. It also requires greater agility and high maneuverability to be used as a product. Also, the bark of some trees may not be strong enough to bear the weight of the climbing device, hence conventional climbing robots cannot be used for tree climbing applications (Jacob and Haridasan, 2015).

Development of robotic or autonomous climbers which can take harvesting tools or spray lances to the crown of the palm has been identified as a potential area of research. According to available reviews, robotic palm climbers like mechanical climbers utilizes two major mechanisms discussed earlier i.e., clamping and climbing. Numerous designs of end effectors for clamping the unit to trunk and moving the unit upward and downward are used, all of which are having specific merits and demerits.

The present study envisages an investigation on the clamping and climbing mechanisms employed in mechanical and robotic palm climbers for evolving a suitable design for semi-autonomous palm climber suited for arecanut palm. As biometric properties of palm influence the design and performance of climbers, a study on relevant biometric properties was also included in this research. Categorizing different designs of palm climbers, analysis of their suitability for different palms, studying the merits and demerits of different designs are the major sub components of this project. The specific objectives of this research work are;

1. To study the prevailing clamping and climbing mechanisms used in mechanical and robotic palm climbers.
2. To identify and investigate the biometric properties of palm which influence the design and performance of robotic palm climbers.
3. To design and develop a semi-autonomous palm climber.

REVIEW OF LITERATURE

CHAPTER II

REVIEW OF LITERATURE

Brief reviews of work done relevant to various aspects of the present work are reported here. In view of the objectives of the present investigation, review on various methods adopted for palm climbing in the past and present and the clamping and climbing mechanisms used in mechanical and robotic palm climbers were reviewed and presented. The reviews are categorized under the following sections.

- Biometric properties and their measurement
- Mechanical palm climbers
- Robotic palm climbers

2.1 BIOMETRIC PROPERTIES AND THEIR MEASUREMENT

The works on various biometric properties of palms which affect the design of palm climbers are presented in the following sections.

2.1.1 Diameter

The tree diameter could be directly measured using caliper which was held 1 m above from the ground level Anon, (2012). The arms of the caliper were adjusted on opposite side of the tree trunk and perpendicular to the tree sides. The diameter of tree was read on the scale. The angle of tree varied along the distance and so calipers must held at the same angle of lean of the tree, if lean was present.

Powell, (2005) studied about the measurement of big trees and stated that diameter was measured by the steel tape and should not be measured with the stretchable material. The diameter can be measured by wrapping a piece of thread around the tree which gives the circumference of the tree. The circumference can be measured by steel tape and the diameter can be calculated from this measured circumference. The diameter was measured at 1.37 m above the ground level.

Elzinga, (2005) studied about observer variation in tree diameter measurements. The two experienced professional foresters measured the tree diameter for 879 permanently marked trees and observed that error rates were almost identical between the observers. The error rate of 5% was observed in the measured tree diameter.

2.1.2 Height

Chave, (2005) studied combination of a laser rangefinder and a clinometers to measure tree height for tropical forest trees. Results observed that the laser rangefinder (Nikon Laser600) receives the measurements in meters or in yards, from 10 m to about 100 m, by increments of 0.5 m. The Nikon Laser 600 comes with one CR2 Lithium battery; with just one battery more than 6,000 measurements can be achieved.

According to Powell (2005), a clinometer or relaskop was mainly used to measure the height of the trees from the ground level to the tip of the tree. The study stated that it was very important to be stand far away from the tree to measure the height of tall tree i.e. within the accurate range of the scales in a relaskop or clinometer. The long tape was needed to measure the distance between the observers to the tree. The measurement of tree height on level ground was easy but while working on steep slopes, it can be riskier and the instrument readings need to be adjusted to change from slope distance to horizontal distance.

Bragg, (2008) conducted a study on an improved tree height measurement technique and it was tested on mature southern pines. For tree height determination two principles were followed: tangent method or similar triangles method. Tangent method was used by most of the people to measure the angles at the top and bottom and an exact horizontal distance to measure the tree. The other method was sine method used to measure height at the real point in the crown. And also stated that the sine method was insensitive to distance from tree or observer position and it cannot over estimates the tree height.

2.1.3 Tilt angle

Wang and Chen (2012) measured tilt angle using triangulation in their study related to landslides. The two sets of three ultra-high resolution panoramic images were used to triangulate the locations of the trees. The triangulation was done for the tops and bottoms of the tree trunks, respectively. The tilt angles were calculated using simple trigonometry. The results showed that the method achieved its purposes, and it could be applied to the future monitoring of unstable slopes.

2.2 MECHANICAL PALM CLIMBERS

A brief review of mechanical devices developed for climbing trees and palms are presented below.

A combination tree stand and game cart was developed by Harley (1967). It was a wheeled platform and the same platform was attached to the tree trunk above ground level using platform projecting laterally from the trunk and fixed in position. The platform can be used as a game cart when detached from the tree trunk.

The tree climbing-hunting platform developed by Baker and Walters (1969) consists of a base plate to be placed significantly horizontally opposite to the side of a tree. A V- shaped blade extending from the back side of the base plate was implemented to bite into the tree which helps to grip the tree. The climbing can be done by placing the arms around the tree surface and pulling up the base plate with the feet. A foot strap was placed on the top side of the base plate, which was self-supporting and it was in raised position so, the weight of the person who climbs the tree was distributed over the plate.

Cotton, (1976) developed a tree climbing device which consists of two platforms which were placed around a tree trunk one above the other. Both the platforms have v- shape tree engaging bars to grip the tree surface. The climbing can be done by sitting the person sitting on the upper platform and lifting the

platforms by hand. Both the upper and lower platforms have an adjustable tree engaging frames which were placed around the tree trunk.

The tree climbing stand was developed by Joseph (1976). It consists of a standing platform made of rigid sheet material. A pair of tubular runners was placed on both the side of the stand. The stand consists of v-notch which was present at the centre of the stand and teeth projecting along the sides of the notch to secure the stand to the tree. The runners were placed outside the end and cross bar has a serrated plate which was placed at the centre. Notches were provided to the stand to place the feet of climber and a seat was provided above the notches. A hand climber attachment for a stand consists of tubular handle and rope.

Horace, (1985) developed a palm climbing apparatus that consist of two platforms, the upper platform for seating arrangement and the lower platform for foot support, both Y-shaped. A metal frame with removable blades helps in engaging the palm or gripping the palm. The climbing was done by raising the upper platform by hand and lifting the lower platform by foot.

The hang on type palm climbing aid developed by Williams (1989) consists of rectangular frames with adjustable locks to clamp the unit or platform to the tree. By raising the upper unit using hands and lifting the lower platform by foot one can climb the tree. The lower platform consists of a climbing band for encompassing the palm. The platform seat and band engrosses the palm at the three different points to provide stability. A safety rope was provided to a seat, which has a Chinese knot for tightening the rope beside the palm. The climbing platforms were equipped with adjustable locks so, as to use for the trees having varying diameters.

Amacker, (1992) developed a universal compact and versatile palm stand with a seating section having at least one pair of longitudinal side members supporting a seat and means for gripping a palm connected at one end of the side member. A cross member was provided so as to reversibly extend the seating section which can also be completely removed from the seating section. A foot supporting section with a rectangular frame is divided into two frame sections.

The two frame sections could be separated so that the frame was reassembled for climbing and used as a palm stand or disassembled to reduce the length of the foot supporting section for transportation and storage. The seating section can also be used as a hand climber.

A climbing palm stand apparatus comprise of two frames was developed by Gardner (1992). Each frame had a rigid base portion with flexible adjustable palm encircling bands. A turnbuckle was connected to the end of each band for drawing together and separating the ends so as to change the effective length of the band. The rigid base portion of each frame has palm gripping edges with the bands and resiliently biased braces act to secure each frame to the palm. Adjustment of turnbuckles changes the attitude of the base relative to the ground. One of the frames was positioned above the other on the palm and they have alternatively rose up the palm or lowered down the palm.

As reported by Louk (1993), the hunter's palm stand consists of two platforms both the platforms have a supportive metal frame. One frame has a web fabric seat for seating and other was curved open metal grid platform for standing. Both the platforms were supported by stiff portable bars, which can be folded easily for storage. A flexible steel cable was placed around the palm, which can be adjusted as per the diameter of the palm. A curved serrated blade extending from the metal frame and the combination with the enclosed cable helps to hold the stand firmly in the palm sitting under load without penetrating the bark or otherwise injuring the palm. The enclosed cable and foldable support gave a secure feeling to the climber while climbing the palm.

Reggin, (1994) developed a portable palm stand which consists of two horizontal platforms, easily mountable to the trunk of the palm. A vertical mounting structure extends downward from the horizontal platform was connected to the back side of the horizontal platform. A cantilever support structure was connected between base of a vertical mounting structure and front side of the horizontal platform, which allows the upper surface of the horizontal platform to be unobstructed. A number of spurs extended backward from the

vertical mounting structure grips the tree surface without causing damage to the palm. A link chain held or secures the stand to the palm.

A tree stand shroud was presented by Stuart (1997) for use in combination with a conventional climbable type tree stand which enjoys widespread usage among deer hunters. The shroud was formed from a flexible camouflage fabric and can be easily folded into a small package for carrying by the hunter. The shroud includes Velcro type fasteners along the top edge for releasably attaching the shroud to the tree stand. A draw cord along the bottom edges allows the shroud to be closely gathered around the footrest section of the tree stand to prevent deer or other game animals from being frightened by inadvertent movement of the hunter.

The convertible palm stand for rifle/bow use developed by Louk *et al.* (1999) consists of two platforms for supporting frames. One frame has a web fabric seat for seating and other was curved open metal grid platform for standing. The seating platform might be mounted to the palm in two positions. One position locates the front end in a downward direction which opens the front end for use in bow hunting. The second position was inverted, with the front end located in an upward direction so that it would define a rest surface for rifle hunting. A flexible steel cable was placed around the palm, which can be adjusted as per the diameter of the palm.

Morris, (2002) developed a climbing tree stand which consists of first platform and a second platform. The first and second platforms comprise a base frame, a first arm and a second arm, a support arm, first and second illumination assemblies, and a blade attached to an upper bracket of the base frame. The first and second arms were pivotally attached to the base frame and are releasably engageable with the support arm. The support arm includes curved portions at opposed distal ends thereof. The first illumination assembly was attached to a distal end of the first arm and the second illumination assembly was attached to a distal end of the second arm of each platform. The second platform includes a foot

support lifting bracket attached to its base frame. The foot support lifting bracket is comprised of a rigid, non-flexible structure.

Graham *et al.* (2003) developed an adjustable palm stand which consists of a seating section and a standing section. Each seating and standing section having an inclined attachment bars adjacent to the section sides and seating and standing section cables, each having first and second ends with handles at each of the ends. Each attachment bar had outer and inner faces with a plurality of spaced, aligned attachment holes extending between the faces, and a plurality of spaced, aligned latch holes alternating with the attachment holes. Each of the handles had a pair of flanged projections insertable into adjacent attachment holes in an attachment bar, and a latch pin insertable into a latch hole between the adjacent holes. Each projection was moveable from an insertion position to a locked position within a hole. When the cable was tensioned and was prevented by the latch pin from moving back to the insertion position, when the cable was relaxed.

Appachan, (2002) developed a device to climb arecanut or coconut tree. The climber consists of metal wire ropes for clamping. By lifting the leg the user has to climb the tree. The device was simple and easy to use and it was used to climb up or down the coconut, arecanut and other similar palms. This climber was very useful for collecting the nuts and spraying pesticides. It reduces the drudgery of climber and it allows the climber to climb faster using less energy.

Joseph, (2006) developed a coconut climbing device which consists of two frames, left and right. Both the frame had palm gripping rubber pads and flexible encircling iron rope mounted around the palm. Each frame member had an adjustable lock for changing rope length according to the girth of the palm. An elastic strap helps the climber hold his feet inside a strap. The two frames were fitted on the palm side by side allowing the operator to lift the frames conveniently using the sliding member.

The coconut tree climbing device was developed by Jawaharlal in 2010. It consists of two similar assemblies. In this construction steel rope, wires were used as grippers those can be adjusted to the diameter of the tree by applying the force

of the user towards gravity. In this climber, there is no support for the body while climbing so, it may cause fatigue to the climbers or users.

To overcome the usability, ergonomic and safety aspects of the problems Edachari *et al.* (2011) designed a coconut tree climbing device which consists of steel wire ropes looped around and locked for gripping of the palm. Then by the simultaneous movement of hand and foot, the user can climb the palm. This device has a weight of 7 kg and the user can climb up to 40 m in 2-3 min. A flat foot rest and safety belts were provided. The safety belts can be adjustable as per the body posture of the climber.

Venkat (2012) had developed a coconut tree climber having seating arrangement, seat belt and locking system. The upper frame was raised by hand and the lower frame was lifted by legs to climb the tree. The user can sit comfortably on seat and climbing can be done by the up and down movement of frames. The locking system enables the climber to work without fear at any height. By using this climber the user can climb up to 12 m in 5 minutes. This can be used for the trees having varying diameters.

Hugar *et al.* (2013) reported the design and fabrication of coconut tree climber which consists of steel wire ropes for gripping the unit to the tree. The steel wire ropes of both left and right assemblies have to be looped with the tree and have to be locked to the arrangement provided to the foot rest. As the user lift the assembly by foot the steel rope will get loosened and when he pushes back with foot it will get tightened, by this process the user can climb to the tree easily. The authors stated that, the structure is able to carry a load of 100 kg. It was flexible to change the height of the equipment up to 10 cm according to the requirement of the user and it can be dismantled easily by removing the locking screw which will help in easy transport of equipment from place to place.

The areca tree climbing device was designed, developed and tested by Basavaraja *et al.* (2015), which was constructed to climb the areca tree by applying force on two pedals alternatively. The device has two units' left hand unit and right hand unit. Each unit consists of a T-gripper assembly which locks

the areca tree, a box-beam assembly which acts as a supporting member; pedal assembly which creates the up and downward operation of the climbing unit. Initially, the climbing unit was fitted at the base of the tree after force applied on the pedal of right hand climbing unit; it creates the grip through the steel wire rope that was connected from T-gripper to the pedal. Then the left hand climbing unit was pulled up by using the handle that was attached to the T-gripper assembly. By this the areca tree can be climbed to a maximum height of 12 m by repeating the operation, the reverse operation was followed to descend the areca tree. And an average of 15-20 trees can be harvested or sprayed by climbing the single tree.

CPCRI, Kasaragod developed a coconut and arecanut palm climbing device which consists of a pair of U-shaped metal frames with rubber bushes and a foot rest. Vulcanized rubber was used to laminate the U-shaped frames to get a good grip with the coconut and arecanut tree trunk. The provision was also given on the foot rests for the user to fix a pair of shoes of his size and choice. The heel of each shoe was at the open end of the long arm of the device. The length of the middle arm of the U-shaped frame can be altered to suit the size and diameter of the coconut and arecanut tree trunk (Mathew and Krishnan, 2015).

A sitting type coconut palm climbing device was designed and developed by Jaikumaran *et al.* (2016). It was made of mild steel and has a weight of 9.35 kg. Its ergonomic evaluation and field performance were conducted. The total time taken to climb a 12 m height by the operator using developed climbing device was 3.16 minutes. The angle of inclination of the upper and lower metal wire rope and seat with horizontal was found to be below the safe value. The strength of wire rope used was tested for breakage and found fit. The bearing capacity of the materials and climbing device as a whole was found to be 165 kg and it did not show any failure. This device could easily be operated by any unskilled person and safety of the operator was assured during climbing.

2.3 ROBOTIC CLIMBERS

It has been reported that research works on robotic palm climbers has been initiated as early as 1900's. Considering the development of technology, research works from 2005 is only reviewed in this section.

Kinematics modelling of a wheel-based pole climbing robot (UT-PCR) was done by Baghani *et al.* (2005). An appropriate set of coordinates was selected and used to describe the state of the robot. Nonholonomic constraints imposed by the wheels were expressed as a set of differential equations. By describing these equations in terms of the state of the robot an under actuated drift less nonlinear control system with affine inputs that governs the motion of the robot was derived.

Kawasaki *et al.* (2008) developed a climbing method for pruning robot. The method of climbing was similar to the existing climbing approach of timber jack in japan. It has an innovative climbing approach that the position of centre of mass of robot was located outside the tree. It consists of four wheels which were set at regular intervals around the tree. One pair of wheels was set at upper side and other pair of wheels was sets at lower side. Each wheel was driven by DC motors through worm gears that have no back drivability. The robot was light in weight and has a high climbing speed.

Sadeghi and Moradi (2008) designed and fabricated a column-climbing robot (koala robot) which was used to climb columns and not depends on the material and diameter of the columns. The two linear mechanisms were used to grip the column and these grippers consist of power screw mechanism with linear bushes and DC motor. This mechanism provides required force to grip to the column. Two pneumatic jacks were used for vertical movement of climber. This robot was made for surveillance and inspection of pipes in electric industries and oil industries.

Jain, (2010) developed a tree climber which works on two sub mechanisms namely gripping and climbing. It can take the load up and down the tree and pole whenever required. This robot was autonomous and the speed of

climbing depends upon the pitch of the ball screw which was placed for the movement of arms in both upper and lower assemblies. The movement of this climber was like an ape climbing the tree. First the upper arm grabs the tree then the lower arm moves up then lower arm grips the tree then the upper pair leaves the contact with the tree and the body moves up.

Shokripour *et al.* (2010) developed an automatic self-balancing control system for a tree climbing robot. It consists of four wheels and an HM-RF transparent wireless data link module. This module was used for transferring the data between the robot and remote control. An ATmega16 programmed microcontroller was used to generate an appropriate signal for each of the remote control buttons. By separately adjusting the rotation speed of each DC motor the control system balances the robot during the climbing. The speed of DC motors was controlled by pulse-width modulation technique. A two axes tilt sensor was used for concurrently measuring the tilt angle of the robot in both X and Y axes.

A tree climbing robot was developed by Lam and Xu (2011). It has great maneuverability on irregular tree environment and surpasses the state of art tree climbing robots. The robot body was continuum manoeuvre structure and has high degree of freedom. It was equipped with a pair of omni directional grippers that allows the robot to grip the tree to a wide range of diameter of trees. It can be able to climb many trees with branches. Five actuators were used for the mechanism.

An automatic cutting system for harvesting oil palm fresh fruit bunch developed by Shokripour *et al.* (2012) which can move around the palm smoothly with cutting system. A mechanical motor system was designed and provided for the upward and downward movement of the machine along the trunk of the tree. Two DC motors were used for the machine for smooth and successful cutting process. It has a reciprocating mechanism and a toothed blade for clean cutting process. An ATmega8 microcontroller and HM-TR transparent wireless data was used to control the cutting system.

Hariskrishna *et al.* (2014) designed a climbing mechanism for a tree climbing robot. This mechanism was inspired by shrimp known as Stomata pod-

whose entire body acts like a distributed foot facilitating, its movement in the most rugged terrains with agility. Hence this locomotive mechanism has been imitated to make a climber. The grippers are designed in such a way that they hold the trunk of the tree-within a defined range, using the concept of passive compliance. This mechanism can be used to climb poles or straight trees.

Mani and Jotilingam (2014) developed and fabricated a semi-autonomous tree climbing and harvesting robot (COCOBOT). It consists of two mechanism one for climbing and other for harvesting. The robot consists of an octagonal shaped chasis with four active wheels for gripping the tree and the wheels were set at specific intervals around the tree. One pair of wheels was set at upper side and other pair was set at lower side. The main feature of the robot was the location of centre of mass of robot outside the tree and it allows straight and spiral climbing. The harvesting mechanism has an arm with three degrees of freedom and circular serrated blade and an end effector. The nuts were located by vision camera which was presented on the wrist of the arm. Based on the output received from the camera the nuts were harvested using saw blade. The remote controller was used to control the complete movement of robot and harvesting system.

Mittal *et al.* (2014) designed a semi-autonomous arecanut tree climbing robot, which eliminates the necessity of manual climbing the arecanut palm for harvesting the nuts and spraying the adjacent palms. It consists of two units, one unit to clamp the palm and other unit for vertical climbing. It uses two X- bar mechanisms and was mounted on opposite sides. The X- bar mechanism can be expanded or compressed using high torque DC motors. The clamping system uses four-bar mechanism.

Raj and Nayak (2014) reported the design and development of a wall climbing robot. The designed robot was able of climb vertical and rough planes. The robot movement was achieved by using rack and pinion mechanism and adhesion to the wall was achieved by sticking using suction cups. It uses two legs, each with two degrees of freedom. A central box having the essential mechanisms required to perform the movement and adhesion.

Shenoy *et al.* (2014) developed a remote controlled tree climbing machine for arecanut tree. It consists of a base frame which supports all the components to be built upon. It was fitted with four stepper motor sets for the climbing. The frame also has a movable arm on top and also a locking system was provided to attach securely to the tree. The DC motor set consists of a speed reduction kit along with it. This helps to get the maximum torque to climb the tree. The whole DC motor assembly was attached to a spring mechanism to get the required grip between the wheel and the tree. The whole set was controlled by remote. So the entire climbing mechanism and spraying mechanism are controlled by a remote. Movable arm can go up and down and is able to rotate its tip 360°. Its tip can be attached to a cutting mechanism or a weed sprayer. It is also remote-controlled by the operator.

Widanagamage *et al.* (2014) designed an autonomous tree climbing robot utilizing four bar linkage system. The basic consideration of the robot was its mechanical structure and the method of gripping. It uses four bar linkage system for clamping and screw mechanism for climbing. The robot was designed to move upwards against gravitational forces similar to climber. The gripping unit was made to hold both upper and lower part of the structure to the tree. The robot successfully climbs the tree having a diameter of 15 to 25 cm.

Fengyu *et al.* (2015) worked on kinematic and dynamic analysis of a cable-climbing robot to inspect broken cables or a cracked protective layer on cable-stayed bridges. The 3D complex obstacles that came across on cables were described theoretically to examine the difficulty in climbing. A climbing model was proposed and the proposed model was used to design the robot. The two wheels which were independently supported by spring were used for gripping. Kinematics and dynamics models were further derived for the obstacle-climbing capabilities of the driving and driven wheels of the robot.

Jacob and Haridasan (2015) developed an autonomous tree climbing robot. The robot was made to analyze and climb on the tree autonomously. This robot was inspired from human pole climbers and relies on wheel mechanism to ensure

smooth and fast climbing motion. The robot has been modelled and designed using 3-D design software. L293D Motor driver is used along with PIC 16F877A and 7805 – 5v voltage regulator for micro controller. The electronic compartment was developed to accommodate the electronic parts on board. The authors reported that, this robot was used for fuming and harvesting the tall trees in a safe manner.

Nallusamy *et al.* (2015) designed a tree climbing robot, which climbs the tree autonomously by realising the environment. The design was inspired by inchworms. With the limited switches the algorithm rebuilds the shape of a tree. The algorithm describes how to realise the environment with the limited information. Realising environment was a complex and challenging task because the shape of the tree was irregular and complex. The robot was so equipped and has well-balanced mechanical design with minimal sensing resources (limit switches) it can climb the tree surfaces. It can only climb the branchless, regular and irregular shaped trees. The robot was equipped with a pair of omni-directional grippers that enables the robot to adhere to a wide variety of trees with a wide range of gripping curvature.

Peter *et al.* (2015) designed and constructed a tree climbing robot. The prime consideration in designing tree climbing robot was the motion planning and method of gripping. A mechanical unit consists of two segments joined by a spine which can be extended or retracted. Each segment has four legs and sharp end as feet. This mechanical structure was designed to move the structure upwards against the gravitational forces in successive upper body and lower body movements similar to a tree climber. The gripping was designed in a way to dig the upper or lower part of the structure in to the tree facilitating the upward movement. The result shows that, it can successfully climb the trees. Authors reported that, tree climbing robot has the potential to be applied to various pursuits, such as harvesting, tree maintenance, and observation of tree dwelling animals.

Raj *et al.* (2015) designed and developed a semi-autonomous coconut harvesting robot. It was inspired by the inchworm mechanism. The grippers were made of aluminium and designed in such a way that, for any diameter of trees it should make a contact with four places. For pressure handling during gripping the rubber over an aluminium rod was used. After the top gripper was fixed the bottom gripper was freed and which moved and it changes the position to 'C' shape. Then bottom gripper was fixed and top gripper moves upward and changes its position to 'I'. The continuum body function was used to move the robot upward and downward directions. This continuum body was extendable and bendable. It was made of 2 bendable parts. Two motors were connected to the two bendable parts, so the grippers can move in both upwards or downward directions. The servo motors were controlled by the micro controllers which were connected to the four major sections; the cutting unit was also controlled by another arduino microcontroller.

Rahul *et al.* (2015) designed a semi-automated coconut tree climber. It was easy and simple to operate. A rough drawing was designed in solid works by considering the average diameter of coconut tree as 30 cm. By using ANSYS a static analysis was done to ensure its stability. Fabrication was done by using a GI steel. The three linear electrical actuators were used for gripping and climbing mechanism – two for gripping and one for the vertical up and down motions. Each actuator can carry up to 400 kg.

Senthilkumar *et al.* (2015) developed an automated coconut harvester prototype. The device was a triangle with a movable third side and consists of three wheels, one attached to each side of the triangle. Two springs, each attached to the other two sides of the triangle help in adjusting to the varying diameter of the tree. Each wheel was driven by a high torque geared DC motor. Two L293D drivers are used to drive the three motors in a bidirectional way. These drivers are fixed on the frame of the device. An RF transmitter/receiver unit was used to provide control signals to the driver. A 12V 3000 mah rechargeable battery pack was used to provide on-board power supply for the receiver, two drivers and the

three motors. An arm with a rotary blade at its end is fixed to one side of the treebot to harvest the coconuts.

Subramanyam *et al.* (2015) designed and developed a climbing robot for several applications. This robot consist of two limbs, each limb had two suction cups. These suction cups were used to stick on to the surfaces. The limbs were connected to the servo motors. A vacuum pump was used to remove the air from the suction cups and was controlled by solenoid valves. The turn switches electricity to solenoid valves were regulated or transmitted using microcontroller. Suction pipes were used to connect solenoid vales to suction cups. By the controller PWM signals applied to the servomotors, the up and down, right and left movements were controlled. The linear motion of the robot limbs was achieved by the rotational motion of gears and joints. An air reservoir was mounted on the climbing robot platform as well. The entire platform can find applications in wall painting application, wall cleaning for high rise buildings. It may be used for glass cutting, if load handling capability was increased.

It was dangerous to climb tall trees to perform some operations like harvesting spraying etc. Therefore, Asfar, (2016) designed a palm tree climbing robot. It was designed to climb the tree and to perform some tasks such as spraying insecticides and harvesting dates. The mechanism of robot consists of three pneumatic actuators; one main actuator and two auxiliary actuators, pneumatic valves, encircling arms and springs. The arms hold the trunk of the tree and both springs and the two auxiliary actuators will keep the arms in suitable positions either to allow the arm to move up or to carry the weight of the robot. The motion comes from the main actuator was applied to the upper arm and the lower one to raise the robot up the tree trunk and was controlled by the valves. Air pressure used does not exceed 6 bars. The movement of the robot to climb up and down was controlled by an Arduino controller.

Dubey *et al.* (2016) developed an autonomous control and implementation of coconut tree climbing and harvesting robot. By referring to the motion of coconut harvester, the kinematics and the motion of the robot were designed. It

consists of two sections joined by a pair of threaded rods coupled to motors. The motorized frame was designed in draft sight software and was implemented using aluminium sections and threaded rods. It consists of two arms which were driven by motors for holding. The locomotion of the robot was achieved using six motors out of which two motors were used for upward and downward motion and other four motors were used in two hands. The robotic arm was attached at the top of the climber for cutting down the coconuts. The operation of the cutting arm was done manually from the ground using a remote. The robot was automated using Arduino-Uno, motor H-bridge drivers, current and level sensors and other supporting circuits.

Prasad *et al.* (2016) designed a wireless palm tree harvester, which provides a better solution for the harvesting of palm trees. In this system, a robot with wheeled leg mechanism was used. Electric motors are used to control the movement of the robot. This robot was made adaptive so that it can adjust its wheels according to the dimension of the tree trunk by the action of compression springs. Controlling unit of the robot is a PIC 16F877A microcontroller. The robot was controlled by giving commands through PC using application software. A robotic arm is provided for cutting purpose. Base, elbow, and shoulder of the arm are servomotor controlled. The robot was controlled using wireless communication, for this purpose ZigBee module was used. It has also got a wireless camera interfaced to know the exact position of the cutting blade.

Tony *et al.* (2016) designed and fabricated an arecanut tree climbing and spraying machine. It consists of a triangular base frame, which supports all the components to be built upon. It was fitted with nylon tyres and rubber grippers at 120 degrees to each other and was powered with three DC motors for ease of the operations. A remotely controlled spraying unit was designed and placed on the frame. The power was supplied to the motors using battery with flexible wires and DPDT switch. The switch was used to control the motion of robot as well as the spraying unit of robot. The DC geared motors having gear reduction ensures the self-locking of the tires and thus maintains the height. A spring loaded mechanism was used to accommodate the change in the diameter of arecanut tree. This

mechanism provides sufficient tension to grip the tree. The device was tested for its performance and it was found safe, reliable, and efficient. It also reduces the problems in climbing and spraying arecanut tree to a good extent.

MATERIALS AND METHODS

CHAPTER III

MATERIALS AND METHODS

The functional components of palm climbers should essentially consist of two mechanisms; the clamping mechanism for gripping the unit to the trunk and climbing mechanism for vertical movement of unit. This work is an attempt to investigate different designs and mechanisms deployed in palm climbers for achieving these two functions. Study on the biometric properties which influence the design and performance of palm climbers are also undertaken as a part of this project. An attempt was also made to develop prototype based on the evolved design so as to analyze its functionality and operational parameters. The methodology adopted for the study and the procedure followed are discussed in this chapter.

3.1 PALM CLIMBERS AND THEIR CLASSIFICATION

A detailed prior art search related to the development and studies on tree and palm climbers were carried out to understand different mechanisms used in climbers. Research papers and other reference material from 1967 to 2016 were collected and reviewed for studying the mechanisms adopted in earlier climbers and the changes or improvements incorporated in due course of time. The works related to both mechanical and robotic climbers were collected from various sources which include published articles, patents, and commercially available designs and also from other online resources. The collected reviews from various resources were categorized based on the mechanisms used, suitability for different palms and merits and demerits etc.

3.2 BIOMETRIC PROPERTIES

The biometric properties of palm influence the design and performance of climbers. Among the quantifiable biometric properties of areca palms, diameter of the palm, height of the palm, variation of diameter along the length, and tilt angle were identified as the major properties which influence the design and

performance. Hence these properties were chosen for the study and the detailed procedures used for assessing these properties are discussed in the following sub sections.

3.2.1 Geographical location of experimental site

The experimental study was carried out on areca palms located in instructional farm KCAET, Tavanur. The areca palms were planted and maintained by KCAET, Tavanur, Malappuram. The study site comes under the border line of Northern Zone and Central Zone of Kerala. A major part of the rainfall in this region is obtained through South West monsoon. The average annual rainfall of this area varies from 2500 mm to 2900 mm. The average minimum and maximum temperature was 25 and 30 °C respectively.

3.2.2 Selection of palms

The twenty palms of mangala and unnamed local varieties present in the KCAET farm were selected for the study of biometric properties. Palms were selected purely based on random number table. Random number table is a list of numbers composed of the digits 0, 1, 2, 3, 4, 5, 6, 7, 8 and 9 and there was no predictable relationship to the digits that predicted it or to the digits that followed it. The twenty palms were selected among the 100 palms for the study. Those twenty numbers were generated by using random number generator. The 20 random numbers from 1 to 100 generated for the study are 79, 54, 84, 89, 65, 55, 20, 72, 40, 94, 15, 89, 27, 45, 48, 25, 39, 78, 67, and 64. The above numbers were selected by numbering the areca palms present in the farm from 1 to 100.

3.2.3 Biometric properties and their measurement

The procedures adopted for estimation of biometric properties of areca palm were discussed in the following sub sections.

3.2.3.1 Diameter

The diameter of the trunk of areca palm was measured or estimated by two methods; directly measuring with vernier calipers and estimating based on the measured circumference.

Direct measurement of trunk diameter was done using vernier calipers. It directly measures the diameter of palm. Calipers were held on the uphill side of the palm. The arms of the caliper were placed on either side of the trunk of palm and perpendicular to the sides of the palm. The diameter of the palm was recorded from the scale of the vernier caliper. The measurement of diameter using vernier caliper was shown in Plate 3.1. Two measurements corresponding to the largest value and smallest value along the same circumference were measured and designated as maximum and minimum diameters. The measurements were taken from one meter above the ground to 9 m, at 1 m intervals.

The circumference of the palm was measured by using a thread and a measuring scale as shown in Plate 3.2. The measurements were taken at the same points on the trunk of palm where maximum and minimum was measured. The thread was wrapped around the trunk of the palm and marked. Then the length of the thread was measured using a measuring scale.

The diameter of palm was calculated by using the following equation (Powell, 2005).

$$C = \Pi \times d \quad (3.1)$$

$$d = C/\Pi$$

Where,

C = Circumference of the palm, mm

Π = (Pi) = 3.142

d = Diameter of the palm, mm



Plate 3.1 Measurement of diameter of areca palm using vernier caliper



Plate 3.2 Measurement of circumference of areca palm using thread

3.2.3.2 Height

The height of the palm was measured by using an android mobile app namely digital spirit level app. The app was calibrated initially by placing the android device on a flat horizontal surface by pressing the calibrate button. The app was also calibrated to the known heights to check the accuracy. By marking the known heights with the help of tape and marker the angles were measured. The height was calculated by using the formula (3.2).

After calibrating the app, the angles were measured to the areca palm by standing away from the palm. The location was selected in such a manner that, the top of the tree was clearly visible. Then by using the spirit level app the edge of the phone was aligned to the top of the palm as shown in the Plate 3.3.

During the alignment, a gunpoint focuses the tip of the palm and shows angle of inclination of edge of phone to horizontal. The hold button in the app freezes the measured angle. The obtained angle was recorded. The distance from standing point of the observer to the tree and the height from observer's eye to the ground (Fig. 3.1) were also measured and recorded.

The height of palm was calculated from the measured angle (Θ) by using the following equation (Anon, 2011).

$$H = (\text{Tan } (\Theta) \times D) + h \quad (3.2)$$

Where,

H = Height of the palm, m

Θ = Angle of elevation or angle between observer eye to the tip of the palm

D = Distance from standing point of the observer to the palm, m

h = Height from observers eye to the ground, m

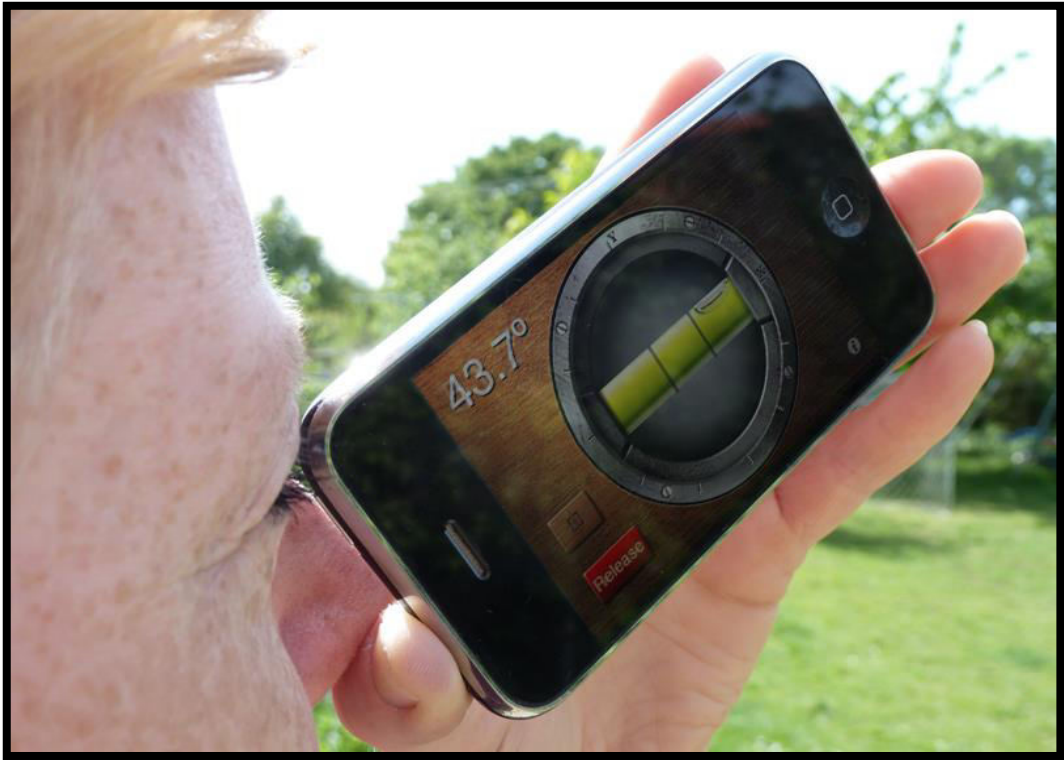

Plate 3.3 Spirit level app focuses the top of the tree

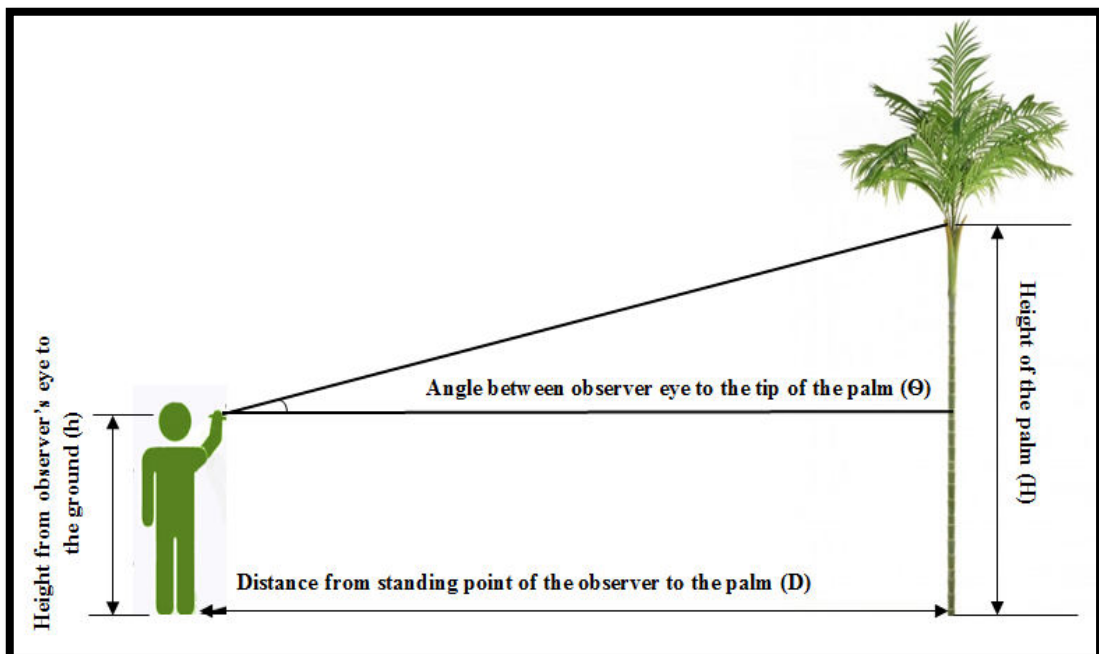

Fig. 3.1 Measurements to obtain tree height

3.2.3.3 Tilt angle

A pendulum like equipment was fabricated and used for measuring the tilt angle at each 1 m interval of the palm. The equipment consists of a 250 mm rod with a U- clamp on one end and a thread of 1 m length with a dead weight at the other end. The U-clamp is to hold the equipment tightly to the trunk of the palm with the rod in horizontal position.



Plate 3.4 Equipment used to measure tilt

The tilt was measured at every 1 m intervals up to 9 m for 20 areca palms. For measuring the tilt of the areca palm the pendulum was clamped to the palm, ensuring that the rod is horizontal. The distance between the free end of the pendulum to the palm (l) was measured (Plate 3.4) and used for calculating the

tilt angle. The tilt angle was measured using following equations and was showed in Fig. 3.2.

$$l = l_1 - l_2 \quad 3.3$$

$$\text{Tan } \Theta = \frac{l}{h} \quad 3.4$$

Where,

l_1 = length of extension rod, cm

l_2 = Distance from thread to the palm, cm

l = difference between l_1 and l_2

h = length of the thread, cm

Θ = Tilt angle of palm

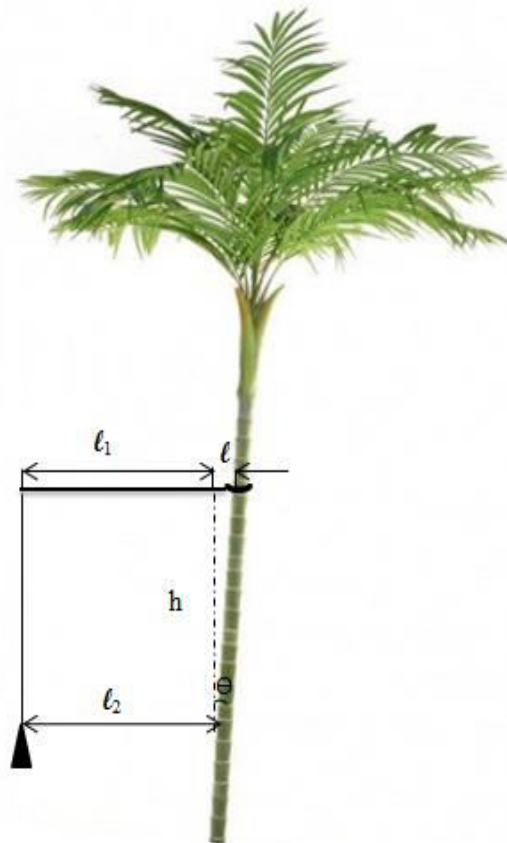

Fig. 3.2 Measurement of tilt to the palm

3.2.3.4 Data analysis

Statistical analysis was carried out to study the variation of diameter along the height of the areca palm using the data analysis tool packages in Microsoft excel.

The areca palms were basically very tall and it was difficult to measure the diameter of palm throughout its length. The diameter of palm was very important in design and control of robots. To predict the diameter of palm throughout its length the regression analysis was used with known values of diameter up to five meters from the bottom of the palm.

3.3 DESIGN CONSIDERATIONS FOR SEMI AUTONOMOUS PALM CLIMBER

The design strategies and parameters for the design of semi- autonomous palm climber were evolved based on the observations made on biometric properties as discussed in section 4.3. Based on the minimal requirements and literature review, it was learnt that the robotic climbers essentially comprise of two mechanisms one for gripping the tree surface which can be termed as clamping/gripping system and the other for facilitating vertical movement of the unit which can be termed as climbing mechanism. The optimal design of an autonomous or semi-autonomous unit should have a proper gripping mechanism so as to hold the unit to the trunk of palm.

As the scope and objective of the present study was limited to design and development of a semi-autonomous areca palm climber, the design of the harvesting or spraying system was not undertaken as a part of this study. The minimal requirements for the climber for performing the operations as listed above are considered to evolve the design.

3.3.1 Gripping system or clamping system

The gripping system should be capable of holding the tree surface firmly and facilitate the climbing unit to move easily throughout the length of the palm.

It should be able to balance the whole unit by a pair of grippers and it needs to move freely through the tree trunk while climbing, without touching the tree surface. The gripping unit should have the stability while in operation, as there is chance of sliding and vibration of whole unit while climbing. It should be robust to carry the whole weight of equipment and at the same time it should be lightweight in order to avoid vibration and sliding. Also, it should have the ability to overcome the obstacles while climbing like variation of diameter and tiltness etc.

Based on the review of different models of climbers, it was found that different types of gripping systems were used. The linear actuator mechanism was used for gripping the trees and columns in numerous designs (Sadeghi and Moradi, 2008; Jain, 2010 and Dubey *et al.*, 2016). These grippers have power screw mechanism with linear bushes and were powered by D C motors. This mechanism provides required force to grip the column. The works by Kawasaki *et al.*, 2008; Shokripur *et al.*, 2010; Mani and Jotilingam, 2014; Jacob and Haridasan, 2015 and Tony *et al.*, 2016 used four active wheels with spring interlock mechanism to grip the tree. The active wheels were fixed at regular intervals around the tree. One pair of wheels was fixed at upper side and the other pair was fixed at lower side of palm. Each active wheel was driven by a DC servomotor through a worm gear that has no back drivability. The grippers were designed in such a way that they hold the trunk of the tree-within a defined range, using the concept of passive compliance. This mechanism can be used to climb poles and straight trees (Hariskrishna *et al.*, 2014). Raj and Nayak (2014) was stated that, the gripping or adhesion was performed by sticking using suction cups. Treebot was also equips with a pair of omni-directional tree grippers that enables the robot to adhere to a wide variety of trees with a wide range of gripping curvature (Lam and Xu, 2011).

The mechanism discussed above were analysed and the mechanism which suits well for the areca palm was selected for the study with necessary modifications. For designing the gripping unit the biometric properties of palm

were considered. The diameter of an areca palm was considered for deriving the horizontal distance between two arms of the grippers. The distance between the two arms of the grippers should be more than the diameter of the tree to avoid the damages caused to the tree while climbing along the tree. Rubber padding was selected as a frictional material for the arms of the gripping unit to hold the palm firmly during climbing.

3.3.2 Moving system or climbing system

The moving system should be capable of holding the two gripping units firmly and it should be able to balance both the gripping units. It needs to move freely along the trunk of the tree during climbing without damaging the tree surface. The climbing unit should have the stability while in operation, as there was a chance of tremble of whole unit while climbing. It should be robust to carry the weight of the gripper and at the same time it should be lightweight in order to avoid vibration of climber.

Reviews on climbing mechanism indicated that different types of mechanisms were utilized effectively. The mechanisms include, actuators like pneumatic jacks (Sadeghi and Moradi, 2008), linear actuators or screw mechanism (Jain, 2010; Hariskrishna *et al.*, 2014; Widanagamage *et al.*, 2014 and Dubey *et al.*, 2016), X-bar mechanism (Mittal *et al.*, 2014), wheel mechanism (Kawasaki *et al.*, 2008; Shokripur *et al.*, 2010; Mani and Jotilingam, 2014; Jacob and Haridasan, 2015 and Tony *et al.*, 2016), and continuum body mechanism (Lam and Xu 2011).

The climbing mechanisms were studied and the mechanism which suits well for the areca palm was selected for the study with necessary modifications. The climbing unit need to move the structure upwards against gravitational forces in successive upper body and lower body movements. The height of the climbing unit was decided based on the biometric properties. This climbing unit should move along the tree freely for climbing.

3.3.3 Control Unit

A control unit was necessary for controlling the operations of whole unit. The motions were to be regulated and controlled for the proper functioning of the climber during climbing. For gripping unit, the to and fro motion of arms have to be regulated. For climbing unit, the up and down motion has to be controlled.

3.3.4 Principle of mechanisms used for clamping and climbing

After comparing the several mechanisms which can produce enough force to grip the palm, the mechanism of power screw was chosen. Power screw was a mechanical device which converts the rotary motion into linear motion and transmitting power. It was also known as translation screw or linear actuators. It uses helical translatory motion of the screw thread in transmitting power. The power screw mechanism was simple to design, compact in construction and it has large load carrying capacity. The manufacturing of screw threads was also easy without requiring specialised machinery. These power screws provide precisely controlled and highly accurate noise less linear motion required in mechanical applications.

The linear actuators were widely used in industrial machineries, machine tools and in computer accessories like printers and hard drives and in many places where linear motion was needed. There are different types of linear actuators used like mechanical actuators, hydraulic actuators, pneumatic actuators and piezoelectric actuators. The actuator used for this study was mechanical actuators.

Mechanical actuator works on the principle of conversion of rotary motion of a motor in to linear motion. The conversion can be done via simple mechanisms like screw type, wheel and axle type and cam type. The rotation of the electric motor was mechanically connected to rotate a threaded rod or screw using a gear. The rod has continuous helical thread with definite pitch. A nut having corresponding helical threads was threaded onto the rod. The nut was prevented from rotating freely with the rod, since it gets interlocked with the non-

rotating part of the actuator. Therefore when the rod is rotated using the motor, the nut will be driven along the threads. Depending upon the direction of the rotation of the rod or the screw, the direction of motion of nut can be determined. This motion of nut can be converted to usable linear motion by connecting necessary linkages to the nut. This mechanism can be used both for clamping and climbing.

3.4 DEVELOPMENT OF PROTOTYPE

Based on the mechanisms identified and evolved design as discussed in section 4.2.2, a laboratory prototype was fabricated for analyzing the functionality. The components of the prototype are gripping unit, climbing unit, control unit and DC motors. The different prototypes were fabricated with minor design changes for evaluating functionality. The details of construction of these two prototypes are discussed in the following sections. The major difference between the two prototypes was the movement of arms. In the first prototype one arm was fixed and the other arm was movable. But in case of second prototype both the arms were movable.

3.4.1 Prototype 1

It consists of a gripping unit with one arm fixed and other arm moving and climbing unit with C-shape supporting structure. The different components such as gripping and climbing units were described in the following sections.

3.4.1.1 Gripping unit

The gripping unit was made by using galvanized iron flats and it consists of a supporting structure, screw rod, V-shape arms, gears and DC motors. Two metal flats of 200×40×2 mm and two metal flats 40×40×2 mm were used to make supporting structure for a gripping unit. A right screw rod of 10 mm was placed between the two supporting bars by making holes on both sides of supporting structure. The V-shape arms were made by using 80×30×3 mm two metal flats. One arm was fixed to the one end of the supporting structure and other arm was made movable and the movable arm was attached to the screw rod by using another square section of 30×2 mm and a right thread nut. A Motor drive for

horizontal movement of arms was provided at the bottom of the gripping unit. The drive transmitted from the motor through gears to the screw rod. A gear of pitch circle diameter 40 mm was directly connected to the motor shaft and another gear of similar pitch circle diameter were connected to the screw rod and this gear meshes with the gear attached to the shaft. The top view and isometric view of gripping unit were showed in Fig. 3.3 and Fig. 3.4.



Plate 3.5 Clamping or Gripping unit

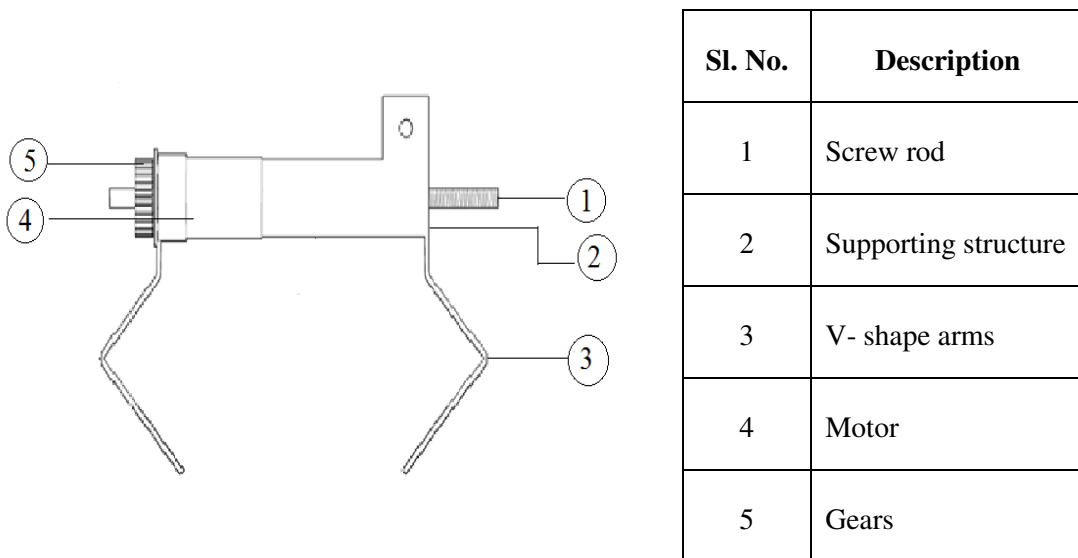

Fig. 3.3 Top view of gripping unit

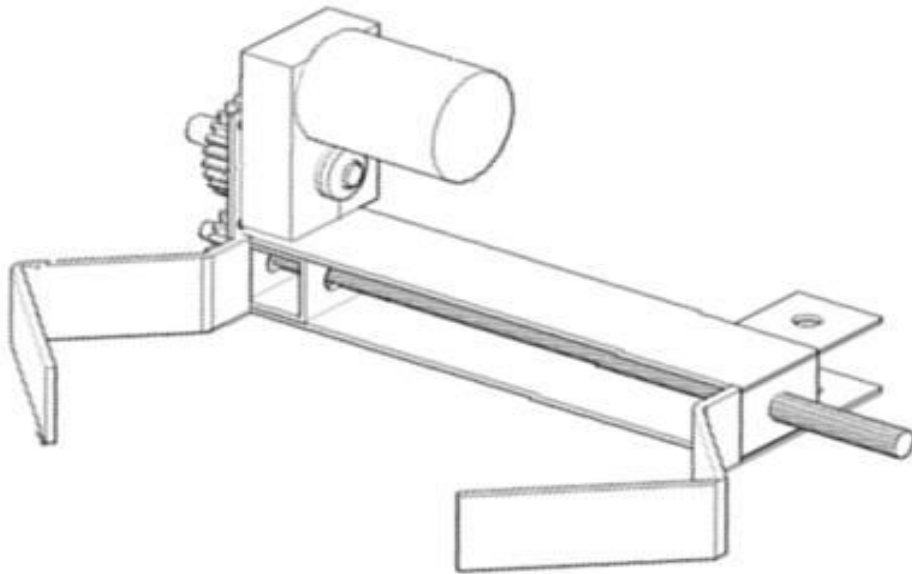

Fig. 3.4 Isometric view of gripping unit

3.4.1.2 Climbing unit

A climbing unit consists of a C-section, screw rod, gears and a motor. The C-section was made by welding three metal plates of 480×40×2 mm. The sides of C-section were closed by using 40×2 mm square flats. A screw rod of thickness 10 mm was placed at the middle of the C-section by making 10 mm hole on both ends. One end of climbing unit was welded with the gripping unit. The other gripping unit was made movable in both up and down directions through screw rod. A motor drive was provided at the top of the climbing unit for upward and downward movement. The drive was transmitted from the motor through gears to the screw rod. A gear of pitch circle diameter 60 mm was directly connected to the motor shaft. The other gear of pitch circle diameter 40 mm was attached to the screw rod and this gear meshes with the gear attached to the motor shaft.



Plate 3.6 Climbing unit

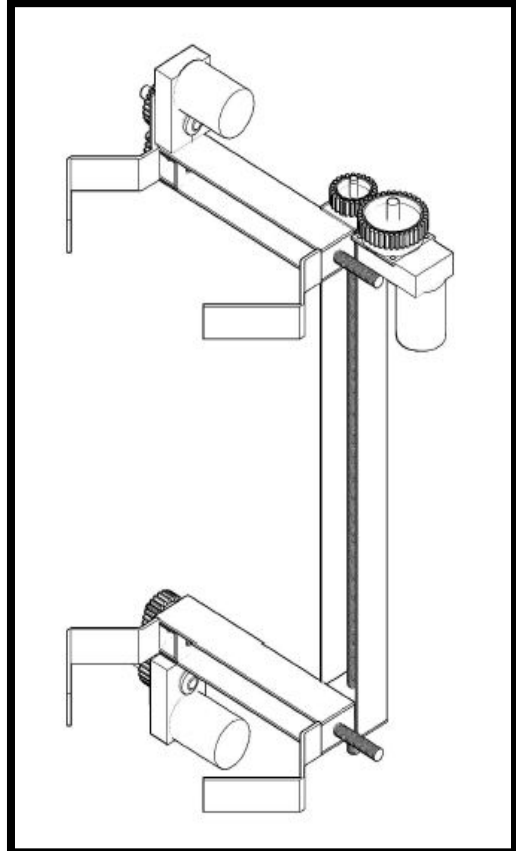

Fig. 3.5 Isometric view of climber

3.4.1.3 Control unit

The control unit consists of a switch panel, main switch, three turning switches, three on/off switches, led, resistor and diode. The three pairs of on/off switches were used to control the motion of the motor. These switches were used to provide a forward and reverse motion to the motors. Three motors were used for giving three separate motions. Two motors were connected to the gripping unit and one motor was connected to the climbing unit through single strand wires which were directly connected to the control board. A 12V DC supply was used as power supply.

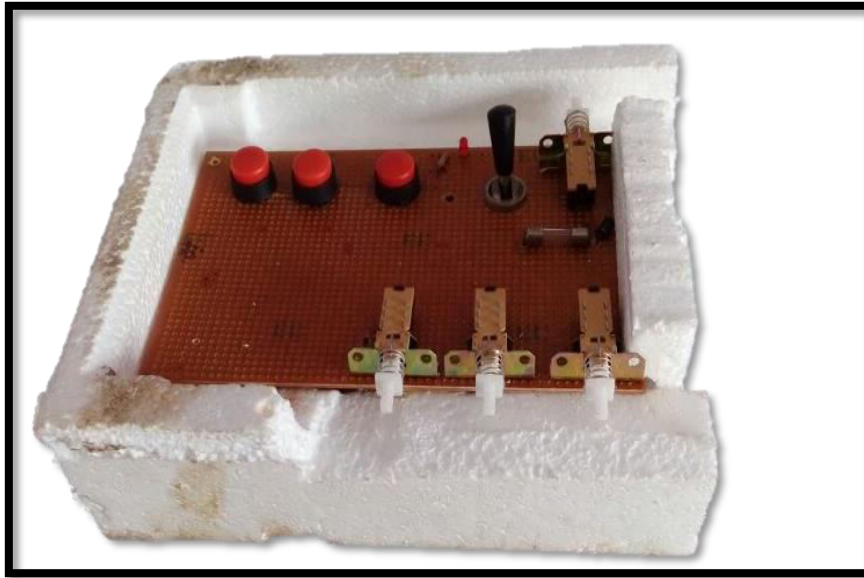

Plate 3.7 Control board

3.4.1.4 Motors

The mechanical power for the gripping and climbing unit was provided by DC motors. A motor was attached at the end of the screw rod of the gripping unit to provide to and fro motion to the arms. Similarly, another motor was attached to the other gripping unit and those motors were placed at the top of the gripping unit. The up and down movement for the climbing unit was provided by another motor. It was attached at the end of the screw thread and fixed at the top of the climbing unit.

3.4.2 Prototype 2

The same motors and control unit was used in the prototype 2. It consists of a gripping unit with both the arms moving and climbing unit with v-shape supporting structure. The different components such as gripping and climbing units were described in the following sections.

3.4.2.1 Gripping unit

The gripping unit consists of a supporting plate, right and left screw rods, circular arms, gears and motor. A 240×100×3 mm metal flat was used as a supporting plate for a gripping unit. Approximately 50 mm width of supporting plate was made V shape and another end of supporting plate was welded with

50×50×3 mm four metal plates. Two metal plates were welded at the two edges and other two metal plates were welded 100 mm away from the edges towards center of supporting plate. The two screw shafts were used to provide linear motion, one was right and other was left thread. Those two screw rods were connected by making grooves and holes using hinge pin and one spur gear was attached between two thread shafts.

Two 70×45×3 mm metal plates and four 20×6 mm circular rings were used to make arms to hold the palm. A hole of 100 mm was made on both the metal plates (70×45×3 mm) one plate was welded with a right thread nut and another plate was welded with left thread nut by placing a nut narrow to the drilled hole. The two circular rods were attached to the two (70×45×3 mm) metal plates at 30 degrees. Another arm was also made by the similar way. A left nut arm was attached to left screw rod and a right nut arm was attached to the right screw rod. Another gripping unit was also made by the similar way.

A motor drive for to and fro motion of arms was provided at the top of the gripping unit. The drive transmitted from the motor through gears to the threaded rods. A gear of pitch circle diameter 40 mm was directly connected to the motor shaft. Another gear of similar pitch circle diameter was connected to the threaded rod and this gear meshes with the gear attached to the shaft.

3.4.2.2 Climbing unit

The climbing unit consists of V-shape supporting structure, screw rod gears and a motor. The V-shape supporting structure was made by using 260×70×3 mm two metal flats. Those metal plates were welded to a V-shape. One end of V-shape supporting structure was welded with one gripping unit and other end was closed by using a metal flat. A screw rod was placed inside the V-shape structure by making hole on both gripping units and a metal plate. Another gripping unit was welded with right thread nut and it was made movable in both up and down direction through thread rod. A motor drive was provided at the top of the climbing unit for giving up and down movement. The drive was transmitted from the motor through gears to the screw rod. A gear of pitch circle diameter 60

mm was directly connected to the motor shaft. Another gear of pitch circle diameter 40 mm was attached to the screw rod and this gear meshes with the gear attached to the motor shaft.

3.5 TESTING OF PROTOTYPE

Based on the design considerations the prototype was developed and which has been tested. Testing was done to know the performance of the climber. The fabricated climbers were tested in both laboratory set up and in the farm. The parameters like weight, speed, installation time of climber, suitable diameter range, and ability of climber to climb in each step and load carrying capacity were measured for both the climbers. The difficulties faced during testing were presented in section 4.5.



Plate 3.8 Testing of fabricated prototype 1 in the lab set up



Plate 3.9 Testing of fabricated prototype 2 in the lab set up

RESULTS AND DISCUSSION

CHAPTER IV

RESULT AND DISCUSSION

The work presented here is a study on the clamping and climbing mechanisms for the design of semi-autonomous areca palm climber. The gripping and climbing mechanisms used in different types of palm climbers and the biometric properties of areca palm which influence the design of palm climbers were studied and presented in this chapter. A basic design for a semi-autonomous areca palm climber was evolved based on these studies is also presented.

4.1 PALM CLIMBERS – TYPES AND CLASSIFICATIONS

Palm climbers of numerous designs and mechanisms were developed and tested by the researchers and innovators. The developed palm climbers can be categorized based on the type of motion of the unit, the power utilized for actuating the functional components and the mechanism deployed for the actuating functional components. The motion of the climber on trunk of palm was either of continuous, discrete or serpentine (Kennedy *et al.*, 2005). In the continuous type, the relative position of all the components of the unit with respect to a point on trunk will be always changing with time, i.e. the unit will be continuously moving over the trunk.

Palm climbers with discrete type of motion essentially comprise of two sets of similar or apparently similar functional components. In this type, any one set of component of the unit will always be fixed to the tree trunk. Initially one set will be held to the tree and the second one is moved in relation to the first. Then the second set is held tightly to the trunk and the first one is moved upward or downward. This process is repeated so as to make the upward or downward moment of the unit.

Serpentine motion is also a continuous motion. The unit takes S- shape or spiral movement over the tree trunk which can also be termed as undulatory locomotion. Although this motion was identified suitable to palm climbers by

certain researchers (Kennedy *et al.*, 2005); no designs of climbers using this type of motion was found.

These palm climbers can further be categorized based on the power utilized. Design which uses human power can be mainly termed as mechanical palm climbers. These are essentially man positioners which takes human to the top of the tree. Mechanical climbers can be further classified as standing type or sitting type based on how the operator was positioned in the climber. In both standing type and sitting type the locking of unit to the trunk was achieved by the virtue of weight of the operator. The other category based on power utilized was robotic climbers, which are powered by DC motors. These are normally unmanned climbing units which will take the harvesting tool or any other required attachment to the top of the tree. These robotic climbers can further be classified based on the mechanisms by which the unit is held to the trunk, i.e. as grasping mechanism or adhesion mechanism (Sadeghi and Moradi, 2008).

Grasping mechanism was applicable for rough surfaces but, it was not suitable for smooth surfaces. Climbing down was difficult and this method of gripping is used for climbing the 85 degree slopes (Menon, 2004). Grasping can be done by using mechanisms like screw mechanism, four bar mechanism, jaws, claws etc. Adhesion mechanism was used for only specific environments where the surface was ferromagnetic, so for most applications was an unsuitable choice. Adhesion can be achieved by suction adhesion, magnetic adhesion etc. The classification of palm climbers as discussed in this section is depicted in Fig. 4.1.

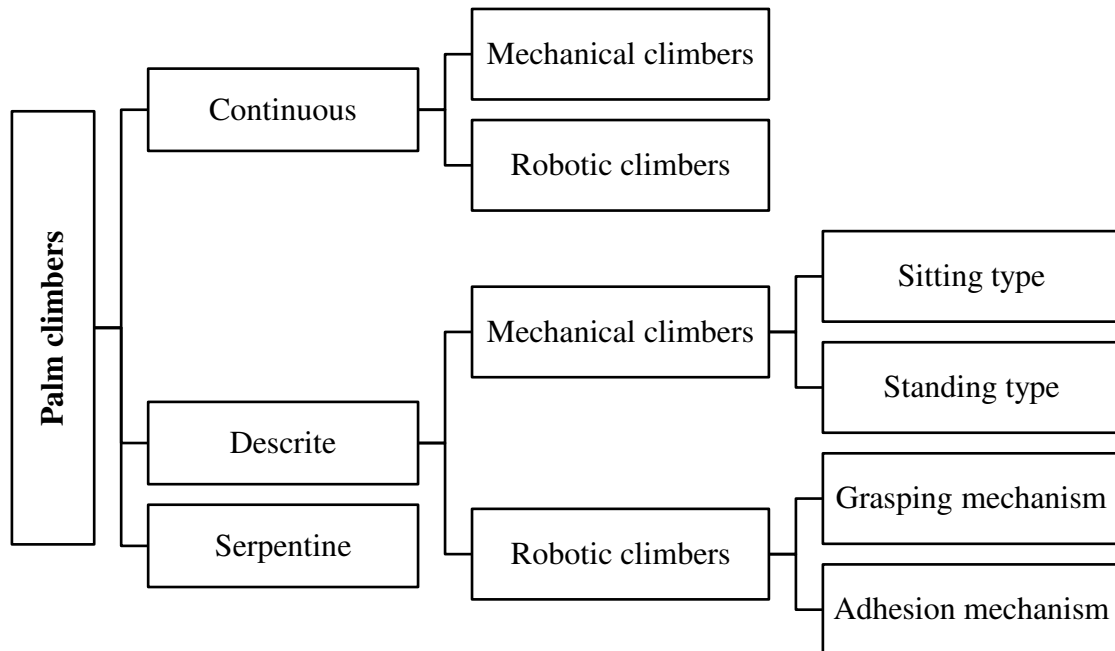

Fig. 4.1 Classifications of palm climbers

4.2 GRIPPING AND CLIMBING MECHANISMS IN PALM CLIMBERS

4.2.1 Mechanical climbers

Mechanical climbers are essentially mechanical man positioners which takes the operator to the top of the tree. All the designs of mechanical palm climbers consist of two sets of functional components which can be moved relative to one another as discussed in the earlier sections. Both the assemblies have clamping provisions for holding the unit tight to the palms. Even though different designs or components were used for gripping the unit to the palm, the clamping was ultimately achieved by virtue of weight of the operator. Climbing, i.e. the upward or downward moment of the unit was mainly carried out by manually lifting or lowering the assembly which is not held tight to the palm. Various mechanisms used by the researchers for gripping and climbing are

presented in Table 4.1. The mechanical palm climbers can be classified into two types based on the position of man during the operation of the unit.

1. Standing type climbing device
2. Sitting type climbing device (Edacheri *et al.*, 2011)

4.2.1.1 Standing type climbing device

Standing type climbing devices consists of metal frames (rectangular and v-shape) and steel wire ropes for gripping the unit to the tree and by the simultaneous movement of the hand and foot, the user climb the tree. The principle of working was based on the fact that, a certain minimum friction between the tree trunk and wire rope was achieved then it will help in adhering to the tree with the help of a wire rope. This adherence depends on the weight of the climber or man and the reaction from the tree for that particular weight (Hugar *et al.* 2013).

The standing type climbers utilizes two climbing mechanisms, by placing the arms around the tree or by holding the rectangular frame using hands and pulling up the base plate with the feet. In this mechanism, the whole weight of the climbing person was on both the hands. In 1969 Baker and Walter developed a tree climbing and hunting platform, which may be considered as the base model for this type and the later versions are developed by modifying, altering or incorporating additional components. The climbing mechanism of this device was similar to the above mechanism.

Another mechanism was lifting and raising the unit by hand and foot. In this mechanism, the whole weight of the body was distributed on the two pedal units, during climbing the motionless foot takes more weight compare to moving foot. The palm climber developed by Appachan in 2002 for coconut and arecanut can be considered as the pioneer work of this type. It consists of wire rope locking as clamping mechanism and lifting or lowering by hand and foot as climbing method. Further developments in mechanical climbers were based on this climber

with improvements in terms of clamping mechanisms, materials and structural components, safety consideration etc. Appendix I provide the merits and demerits of such models.

4.2.1.2 Sitting type climbing device

Sitting type climbing devices consists of steel or metal frames (Rectangular, U- shape, V-shape and Y-shape) and steel ropes for clamping the units to the tree. By standing on the pedal unit, the upper unit was slided up or down using hands and by sitting on the seat unit the pedal unit was slided up or down and by repeating this movement user can climb the tree.

From the available literature, it was found that the first sitting type climbing device was developed in 1976 by cotton. It consists of v-shape tree engaging bars to grip the platform to the tree surface. The climbing was done by sitting on the upper platform and lifting the lower platform by hand and standing on the lower platform and sliding the upper platform by hand which may be considered as the base model for other sitting type devices developed after this device. This model was modified by the many researchers in terms of gripping, climbing, safety and weight. The sitting type models along with their merits and demerits are presented in the appendix II.

Table 4.1 Mechanisms used in the mechanical palm climber

Sl. No.	Gripping	Climbing
1	Steel bars/ metal frames (Rectangular, U-shape, V-shape, Y-shape) frames	Lifting the upper platform by hand and raising the lower platform by foot
		By sitting on the upper platform lifting the lower platform using hands and by standing on the lower platform raising the upper platform by hand
2	Steel wires/ ropes	Lifting and raising the units simultaneously by hand and foot
		By sitting on the seat sliding the lower platform by foot and by standing on the pedal unit lifting the upper unit by hand

4.2.2 Robotic climbers

Climbing robots capable of making upward and downward movements on regular structures like poles, walls, domes etc. has been developed by the several researchers. Majority of these designs were not capable of climbing trees. This might be due to irregular surface and variation of diameter along the length (Harikrishna *et al.* 2014). It also requires greater agility and high manoeuvrability to be used as a climber for palms or trees. Also, the bark of some trees may not be strong enough to bear the weight of the climbing device (Jacob and Haridasan, 2015).

As discussed in section 4.1.1 robotic climbers can be of continuous or discrete motion. In continuous type climbing robot, the unit will be continuously moving over the trunk. The robots having continuous motion were high in speed

and consume less energy, but it was difficult to implement the continuous motion. The common continuous type design is wheeled robot wherein instead of grippers; wheels act as both clamping and climbing component as these models has to hold to trunk of the palm and work against gravity.

Robotic climbers with discrete type motion consist of two sets of functional components as discussed in section 4.1.1. Most of the climbing robots were designed with discrete type of motion. Although robotic climbers with this type of motion consumes more energy and operates with less speed, it is functionally more stable. The different mechanisms comes under discrete motion were presented in the Fig. 4.2.

On reviewing the working of robotic climbers, it can be concluded that the motion of climbers are imitation of any three natural actions, inchworm movement, ape climbing and walking action. Inchworm movement is achieved by the co-ordinated action of head and tail with either of these always in contact with ground. In this action head and tail comes closer and move away continuously to move forward or backward. It may be noted one will not be crossing the other in this type of action. The ape climbing action is also similar to inchworm movement, where either the upper arm or the lower arm always grabs the tree. The relative movement of upper or lower arms along with body facilitates climbing up or down. In walking action either of the legs is always in contact with the ground, and the relative positioning of the legs achieves the forward or backward movement. The difference in this action compared to the other actions is that in this case one will cross the other during the relative movement.

The robotic climbers hold the trunk using either grasping mechanism or adhesion mechanism. Grasping mechanism was used to hold the tree trunk with the help of a pair of jaws or claws etc. Adhesion mechanism was suitable for ferromagnetic surfaces and it can be achieved by suction adhesion, magnetic adhesion etc. The different mechanism comes under grasping and adhesion mechanisms were presented in Table 4.2.

Many palms such as coconut, arecanut and other palms were so tall. The maintenance of these palms, climbing and harvesting the fruits and nuts, becomes risky and difficult. So the development of a unique palm climbing mechanism which suit different types of palms and trees may be difficult, and hence developers had used different designs and mechanisms. The robotic climbers of different mechanisms reviewed during the course of this study are presented in appendix III.

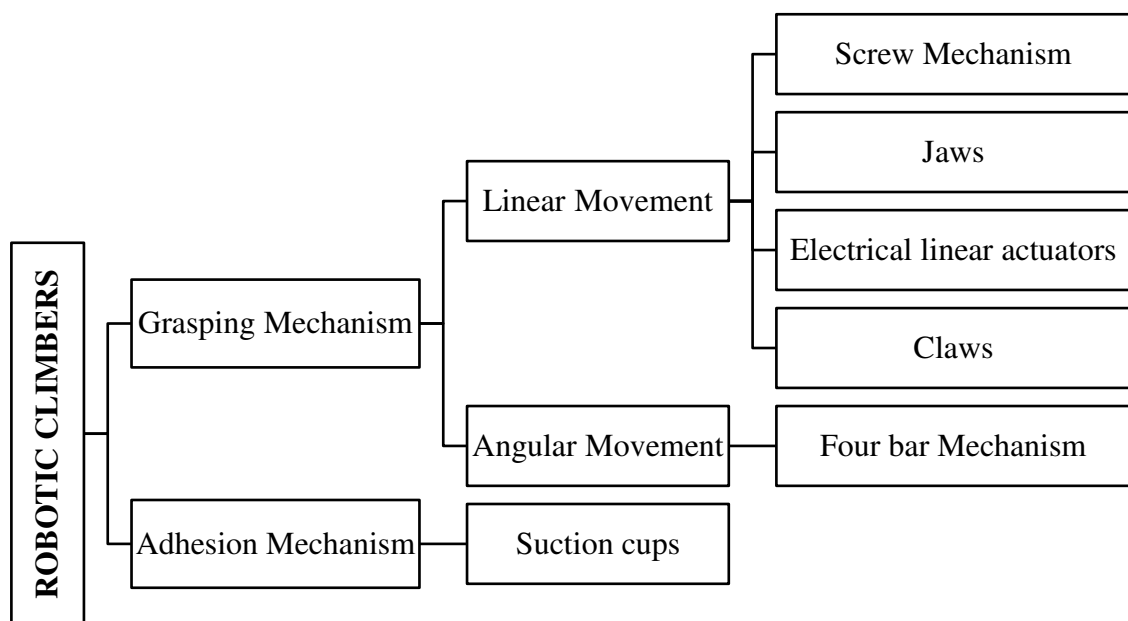

Fig. 4.2 Different mechanisms involved in the discrete motion

Table 4.2 Mechanisms used in robotic palm climbers

	Sl. No	Clamping	Climbing
Grasping Mechanism	1	Screw mechanism	Pneumatic jacks
	2	Four bar mechanism	Screw mechanism
	3	Claws	Screw mechanism
	4	Rubber over hollow tubes	Screw mechanism
	5	Four bar mechanism	X- bar mechanism
	6	Screw mechanism	Screw mechanism
	7	Wheels with spring interlock	Wheels with motor
	8	Triangle and octagon shaped chasis with springs	Wheels with motor
	9	Two angular links, two arms, two straight links and a linear actuator	Electrical linear actuator
	10	Claws	Linear actuator
	11	Rings with radial gripping devices	Linear actuator
	12	Claws	Rack and pinion mechanism
	13	Rubber over hollow aluminium tubes	Continuum body
	14	Claws	Continuum body
Adhesion Mechanis	15	Suction cups	Rack and pinion mechanism
	16	Legs with suction cups	Four bar linkage system

4.2.3 Comparisons of Mechanical and Robotic palm climbers

The mechanical and robotic climbers were used to climb the palms. The mechanical palm climbers are mainly man positioners that will take the man to the top of the tree and the robotic climbers are the autonomous or semi-autonomous climbers which will take the harvesting or spraying tools to the top of the tree as discussed earlier. A comparison of mechanical climbers and robotic climbers in terms of power, load carrying capacity, suitability etc. was done and presented in the Table 4.3.

Table 4.3 Comparison of mechanical and robotic palm climbers

Sl. No.	Mechanical climbers	Robotic climbers
1	It will take man to the top of the tree.	It will take a harvesting tool or other equipment needed to the crown of the palm.
2	It requires muscular power of human.	It requires external power source like battery.
3	Load carrying capacity was up to 400kg.	Load carrying capacity was up to 4kg.
4	Suitable for all the diameter palms.	Suitable for specific diameters.
5	These climbers cause human drudgery.	No human drudgery.
6	It can climb more than 30 cm in each step.	It can climb up to a height of 15–30 cm in each step.
7	Compare to robots, it was fast in climbing.	Slow in climbing

4.3 BIOMETRIC PROPERTIES OF ARECA PALM

The biometric properties of areca palm which influence the design and performance of robotic palm climber are presented and discussed based on the basis of observations taken during course of work. Diameter, its variation along the height of the palm, height of the palm and the inclination represented by the tilt angle of the trunk of the tree were identified as the biometric properties which has direct influence on the design of palm climbers.

4.3.1 Diameter

The trunk diameter of areca palm is the most important parameter which influences the design of areca palm climber. The size of gripping unit, shape and dimensions of gripping arms or structures, their spacing and the distance through which the gripping arms are to be moved for locking and unlocking can be properly assessed only with adequate data and knowledge on diameter. The characteristics and observations made based on the determined diameters using techniques were described in the section 3.2.1 are given below.

The trunk diameters of the areca trees were measured at nine different positions with an interval of one meter, starting from one meter height from the ground. Two diameters corresponding to maximum (D_{Max}) and minimum (D_{Min}) were taken for a particular position. The diameter (D_{Cir}) was also estimated by measuring the circumference of the trunk at that position.

The distribution of various measured and estimated diameters were presented in Fig. 4.3. The measures of central tendency and dispersion were given in Table 4.4. It can be observed from that data taken were normally distributed which indicates the sample taken for the study were reliable and appropriate.

The maximum and minimum diameters among D_{Max} and D_{Min} were 175 mm and 76 mm respectively. The maximum and minimum of D_{Cir} was observed as 181 mm and 80 mm respectively.

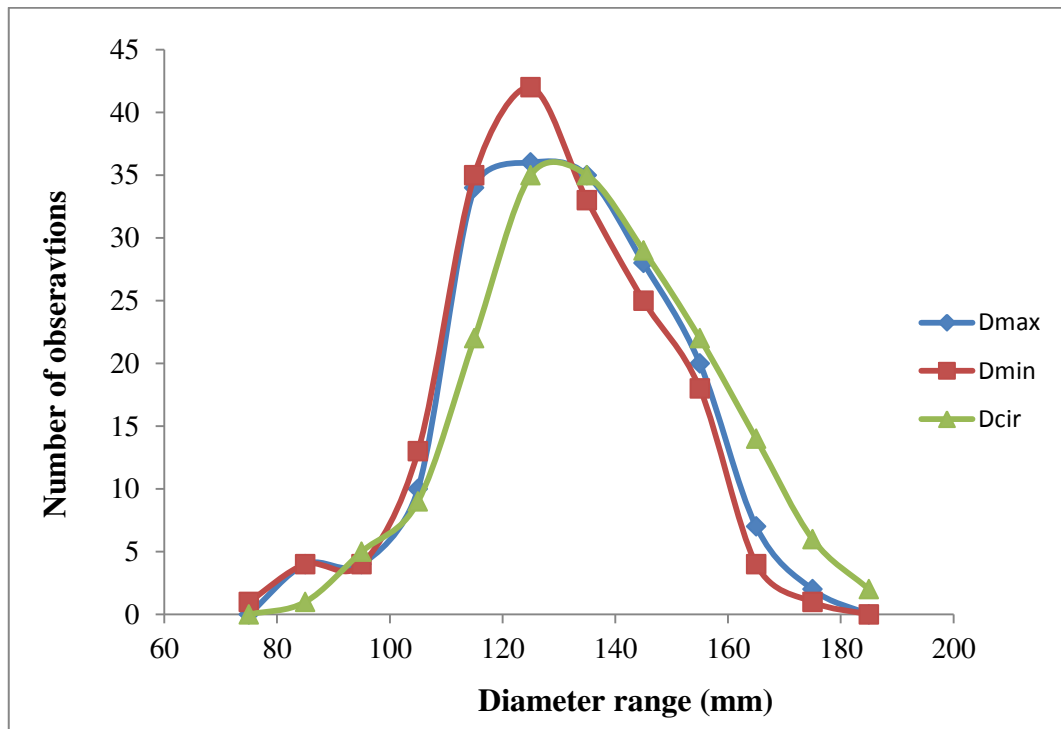

Fig. 4.3 Distribution of measured and estimated diameters

Table 4.4 Measures of central tendency and dispersion

	D_{Max}	D_{Min}	D_{Cir}
Maximum Value, mm	175	174	181
Minimum Value, mm	76	75	80
Mean	126.2	124.5	131.5
Median	126	124.5	131
Mode	121	125	124
Range	99	99	101
Standard Deviation	17.9	17.6	18.6
Sample Variance	321.1	310.6	345.2
Standard Error	1.3	1.3	1.4

The average (D_{Ave}) of D_{Max} and D_{Min} was calculated and compared with diameter estimated by measuring the circumference (D_{Cir}). These details are presented in Table 4.5 and Fig. 4.4. The graph indicated that the spread of data on diameters is almost uniform with the range of 80 to 181mm for D_{Cir} and 75 to 174.5 mm for D_{Ave} . It is also observed that D_{Cir} gives a value more than the D_{Ave} in all the cases and among the three diameters (D_{Max} , D_{Min} , D_{Cir}) the diameter estimated based on measured circumference (D_{Cir}) was higher in all the cases. The higher value of D_{Cir} compared to D_{Max} or D_{Ave} may be due to undulations present on the trunk along the circumference.

The difference between the D_{max} and D_{min} were calculated to analyse the variation on diameter along circumference and is presented in 4.5 and Table 4.6. It is observed that the variation is in range ± 5 mm.

The variation in diameters along the circumference in the bottom 5 m and next 4 m were also compared and presented in Fig. 4.6. This also showed the same pattern as the total variation discussed above.

It may be deduced from these observations that variation of diameter along the circumference was negligible which indicates that there are no major undulations among the circumference of the trunk. Considering these factors and pattern of gripping arms used in clamping mechanisms it can concluded that diameter, estimated based on the measurement of circumference (D_{Cir}) gives a better indication of the diameter of the trunk of palm for the design.

Table 4.5 Measured and estimated diameter of areca palm

	Estimated diameter (mm)	Measured diameter(mm)
Minimum	80	75
1st quartile	120	113.5
Median	131	124.5
3rd quartile	143	137.8
Maximum	181	174.5

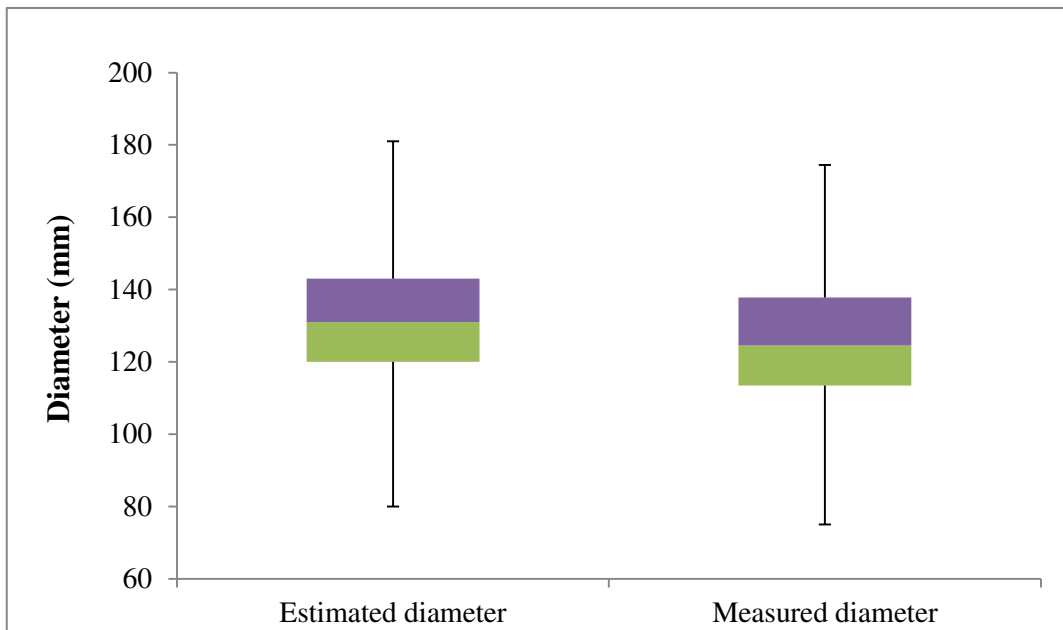

Fig. 4.4 Measured and estimated diameter of areca palm

Table 4.6 Maximum and Minimum deviation

Deviation (mm)	1	2	3	4	5
Range	79	65	25	9	2

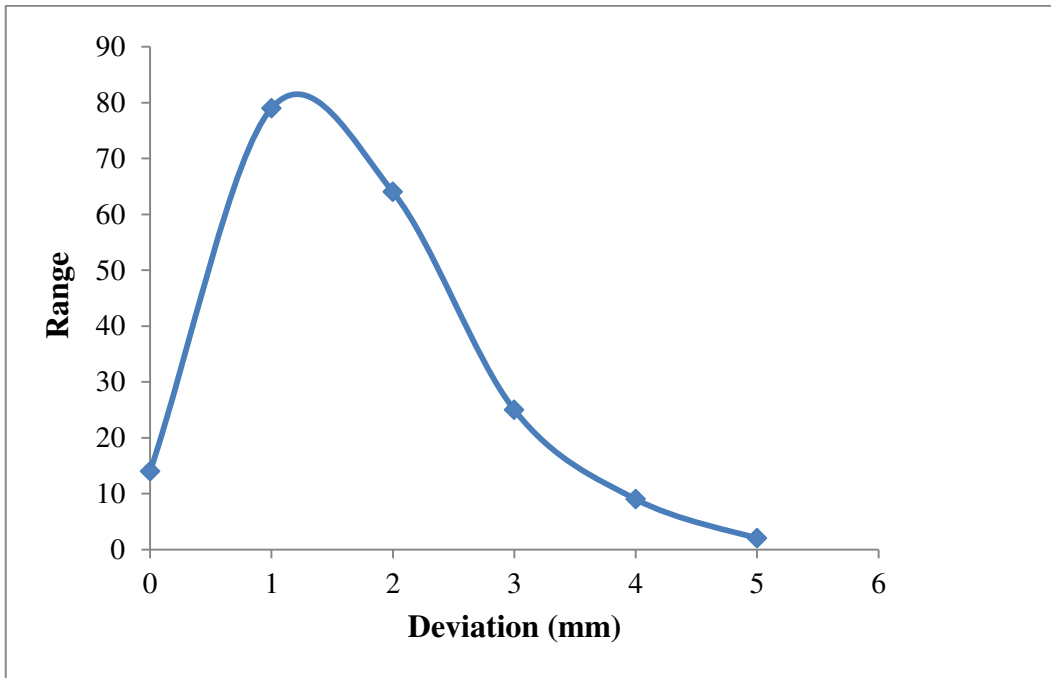

Fig. 4.5 Difference between maximum and minimum deviations

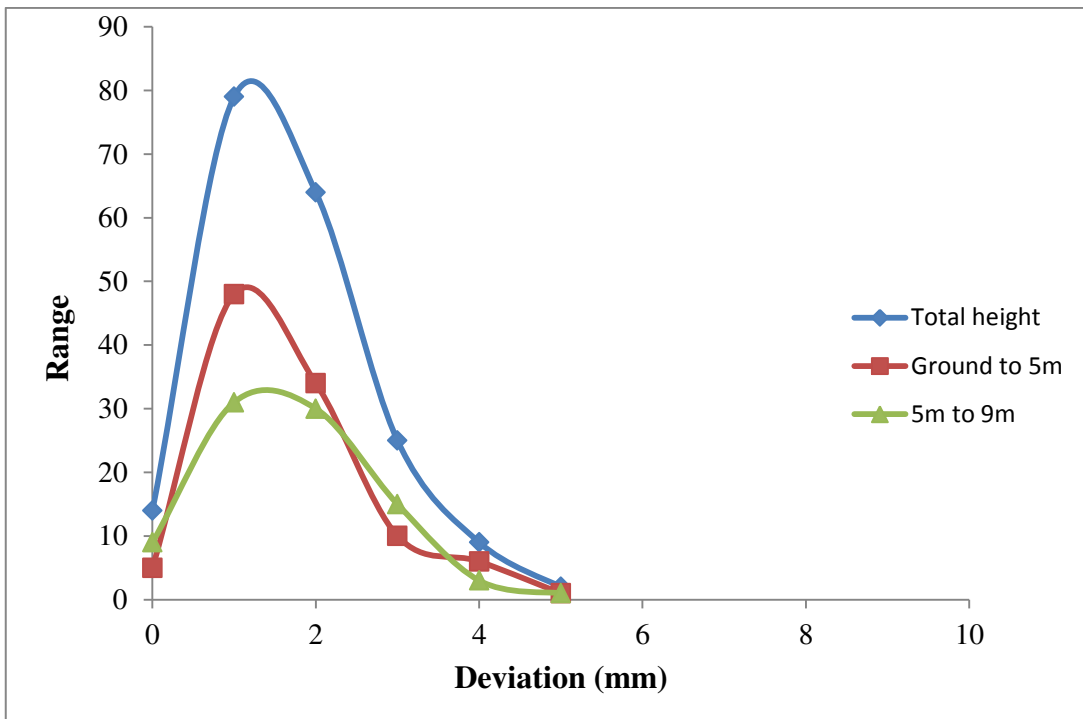

Fig. 4.6 Deviation of palm at bottom 5 m and above 4 m

4.3.1.1 Variation of diameter along height

The diameter of the trunk of the palm is reducing with height from ground. The change in diameter from 1 m above the ground to 9 m was studied and it was seen that the maximum and minimum changes were 92 mm and 26 mm respectively. The maximum and average variation of diameter in one meter height increase noticed was 38 mm and 5.5 mm. In a very small number of cases the diameter has shown slight increase (up to 7 mm), which may be due to irregularity along the circumference as diameter estimated by measuring the circumference was used for the study.

In order to study the straightness of trunk a regression analysis of height and diameter was done. The graphs obtained for 20 different palms are presented in Fig. 4.7 and the correlation and regression coefficients are tabulated in Table 4.7. The R^2 values obtained was between 0.88 and 0.99 which indicates that there is linear relationship between the height and diameter data or in other words it can concluded that the trunk is almost straight.

Use of linear relationship between height and diameter of the trunk at the bottom portion to predict the diameter at the top portion was also studied by predicting the values based on regression analysis. The diameters of palm at the top portions were predicted by regression analysis using linear equation and known values of diameter up to five meters from the bottom of the palm. The variation between the predicted and observed values of diameters were noticed ranging from -0.085 mm to 5 mm, which shows that the prediction gives a reasonably reliable estimate of the diameter.

The variation in diameter is an important property in designing the clamping mechanism and the distance, the gripping arms has to move for locking or unlocking can be depend on this. Having a common value for gripper arm movement throughout the height of the trunk may adversely affect the time taken for climbing and hence a prediction based on height could be effectively used in the design.

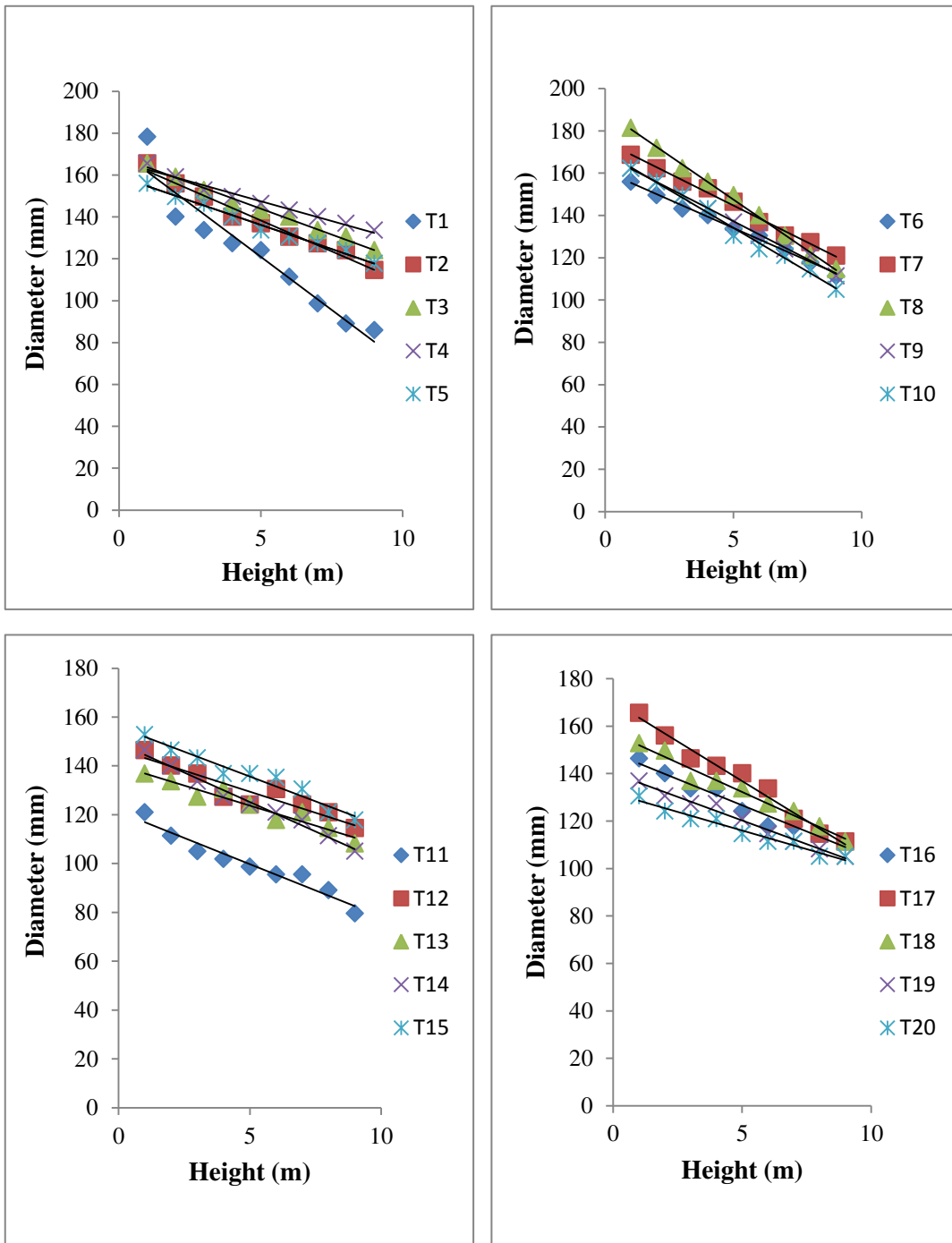

Fig. 4.7 Variation of diameter v/s height

Table 4.7 R² values for linear curves

	R² value		R² value
T₁	0.92	T₁₁	0.94
T₂	0.97	T₁₂	0.88
T₃	0.99	T₁₃	0.93
T₄	0.97	T₁₄	0.98
T₅	0.98	T₁₅	0.95
T₆	0.99	T₁₆	0.96
T₇	0.99	T₁₇	0.98
T₈	0.99	T₁₈	0.97
T₉	0.99	T₁₉	0.98
T₁₀	0.98	T₂₀	0.96

4.3.2 Height

Although the height of palm does not directly influence the design of the climber, it is a major parameter which affects the operation of the robotic climbers. The time required for completing the climbing is directly influenced by the height and when height increases, it will be difficult to see and operate the climber from the ground. The data on height of the palm studied are presented in Table 4.8 and Fig. 4.8. The minimum and maximum height observed were 9 m and 22 m respectively. This was within the range mentioned by researchers Orwa *et al.* (2009) and Tony *et al.* (2016) who had reported that height of the areca trees varies between 12-30 m and 18-21 m respectively depending upon the environmental conditions.

Table 4.8 Height of areca palm

Height (m)	9	10	12	13	14	15	16	17	18	22
Number of palms	3	3	2	1	1	2	2	3	2	1

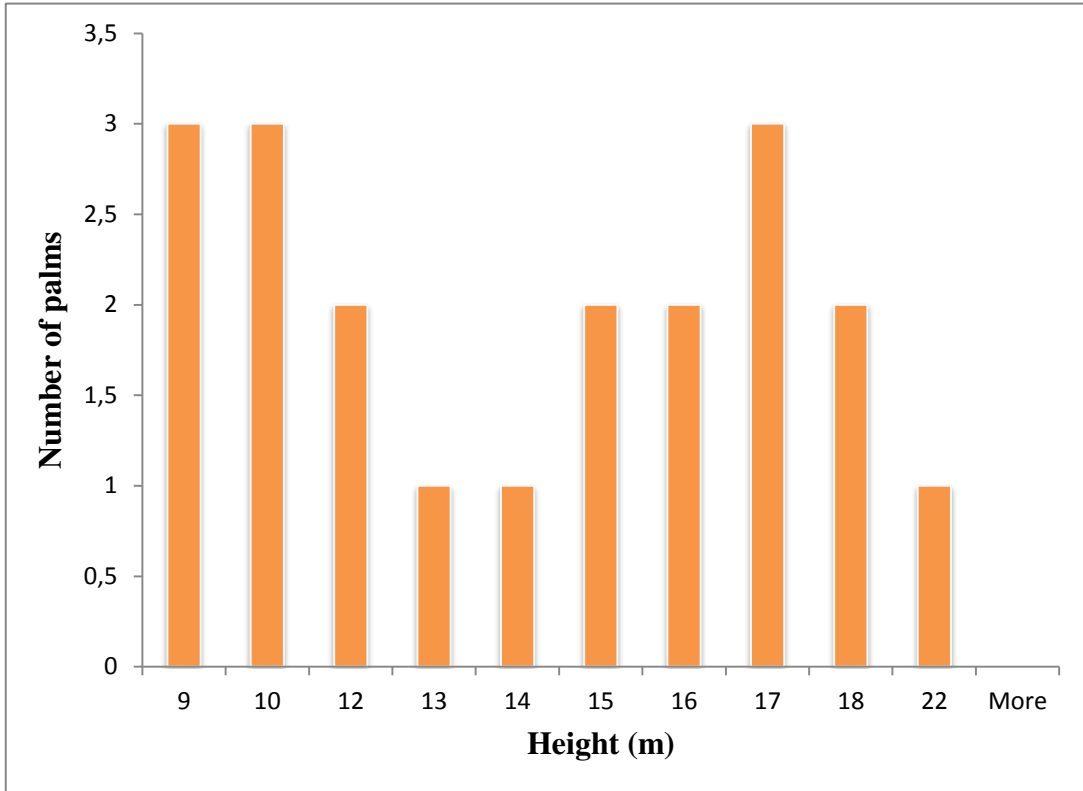

Fig. 4.8 Height of areca palm

The diameter at 1 m height from ground and the height of the palm was studied to see whether there is any relationship between the height and base diameter. The data of height and diameter of areca palm were presented in Table 4.9 and Fig. 4.9. It was observed that the base diameter is comparatively smaller for trees having more height. A 9 m height of areca palms have an average diameter of 17.18 cm and a height of 22 m palm have a diameter of 13.05 cm. When observed the relationship between the height and diameter of palm, the diameter of palm was slightly decreased with increasing the palm height, although a proper relationship cannot be predicted based the observed data.

Table 4.9 Height and diameter of areca palm

Height (m)	Diameter (cm)
9	17.18
10	16.34
12	16.39
13	16.55
14	16.23
15	14.16
16	15.60
17	13.68
18	14.96
22	13.05

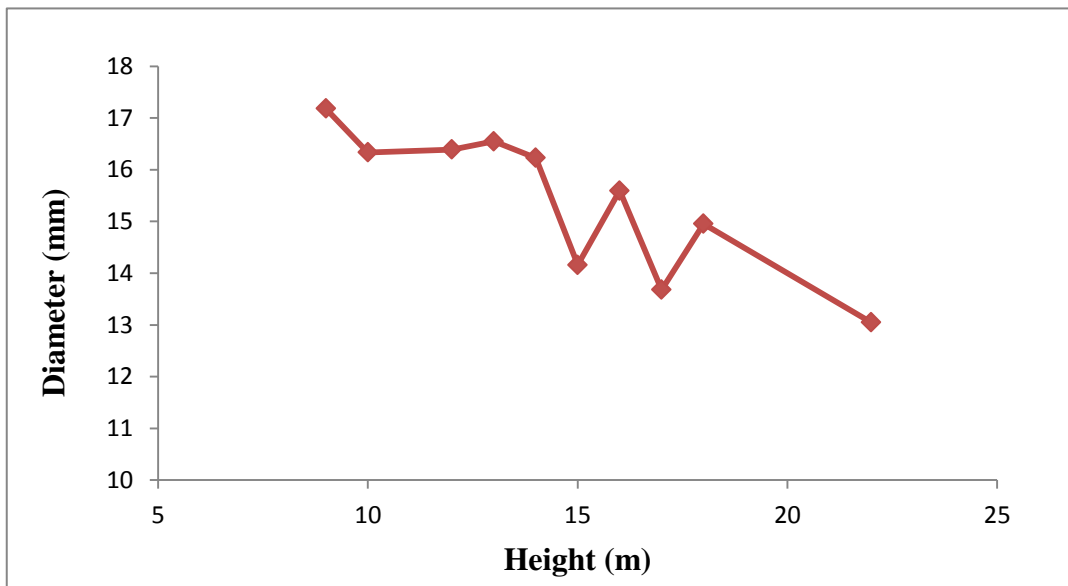

Fig. 4.9 Height and diameter of areca palm

4.3.4 Tilt angle

The tilt angle of areca palm, which is the inclination of palm tree to the vertical plane, can be considered as an important parameter which directly affects the design of climber. Usual mechanisms used as climbing mechanism in robotic

climbers will have a design in which two functional sets makes relative movement along an axis which is almost vertical. Hence the maximum height of the climber and distance of relative movement of one set to other can be designed only if the tilt angle is properly obtained.

The tilt angles of areca palm observed during the study are shown in Table 4.10 and Fig. 4.10. The results of the study showed that, the maximum number of palms has a tilt of 1 to 2 and 2 to 3 degrees. From the Table 4.10 it was clear that the maximum areca palms have a tilt of 1, 2 and 3 degrees. But, the areca palms were basically straight and the obtained tilt angle from the areca palms may be due to variation of trunk diameters along the length of palm. The obtained tilt angle was very less so, it might not affect the design of robotic areca palm climber.

Table 4.10 Tilt angle of areca palm

Tilt angle (degrees)	0-1	1-2	2-3	3-4
Number of palms	1	9	8	2

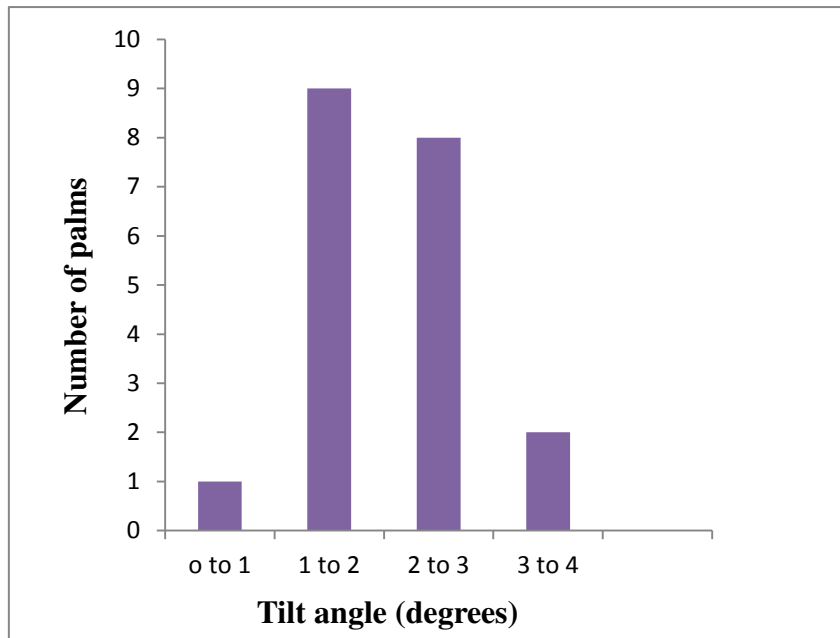

Fig. 4.10 Tilt angle of areca palm

4.4 DESIGN OF SEMI AUTONOMOUS ARECA PALM CLIMBER

As discussed under section 3.3.4, the power screw mechanism was selected for the development of prototypes. An initial prototype was developed, the construction details of which are discussed in section 3.4.1. The developed prototype 1 was tested for different palms having varying trunk diameters. The prototype suits well for the palms having diameter 10 to 25 cm. The climbing unit has a weight of 3.8 kg and it can hold a weight of around 300 gm without failure. During testing it was observed that, the climbing process was slow and the fixed arm of gripping unit touches the bark of the tree while climbing. To overcome these drawbacks the climber was re-designed with two arms movable. The design details of second prototype are discussed in the following sub sections. The mechanisms and parameters of developed prototypes were presented in the Table 4.11.

Table 4.11 Mechanisms and parameters of developed prototypes

Sl. no	Parameters	Prototype 1	Prototype 2
1	Gripping mechanism	Screw mechanism	Screw mechanism
2	Climbing mechanism	Screw mechanism	Screw mechanism
3	Gripping arms	V- shape gripping arms, one arm was fixed other arm was movable	Circular gripping arms, both the arms are movable
4	Width of gripping unit, cm	20	24
5	Height of climber, cm	30	26
6	Weight, kg	3.8	4.3

4.4.1 Gripping system or clamping system

The gripping unit for lateral movement consists of a screw rod, supporting unit, gears and a motor. A left and right screw rod of 1cm diameter and 12 cm length was attached to the supporting unit. Two circular arms were attached to the screw rods and were made movable using suitable nuts. Motor for giving drive was fixed in between two screw rods (left and right). Other ends of the rod were locked using a lock nut. Motor drive gives to and fro motion to the gripping unit and it was mounted at the top portion of gripping unit. The motor drive was transmitted to the screw rod through gears. A gear with 4 cm pitch circle diameter was connected directly to the motor shaft. Another gear with 4 cm pitch circle diameter was connected to the screw rod and it was meshed with the gear connected to the motor shaft. The front, top and side views of gripping unit were showed in Fig. 4.11 to Fig. 4.13.

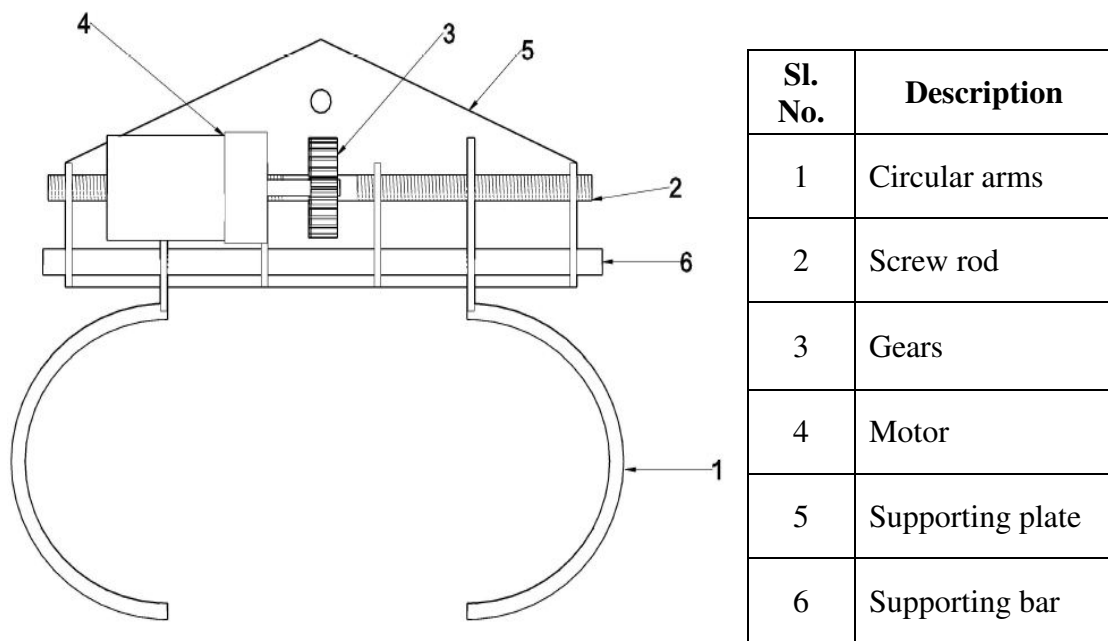

Fig. 4.11 Top view of gripping unit

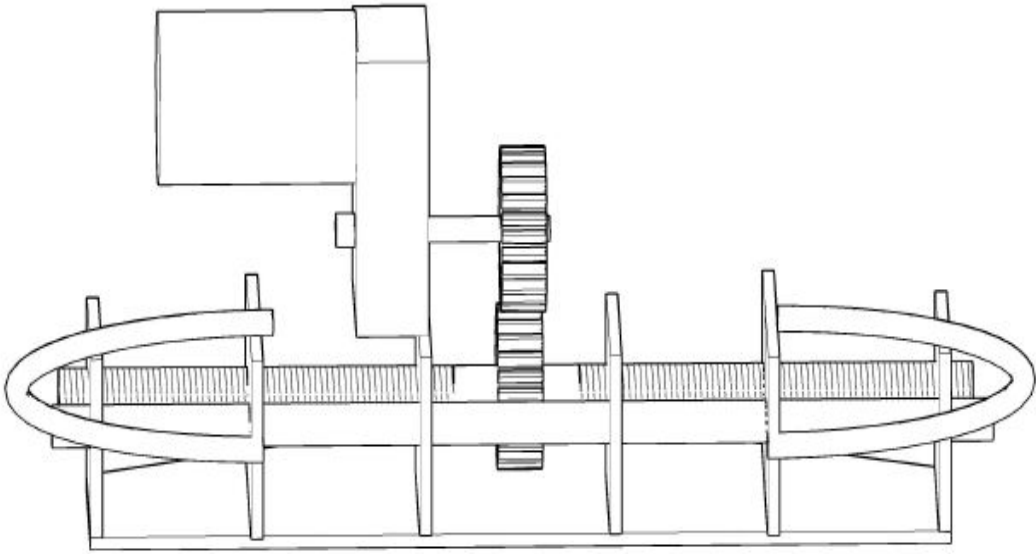

Fig. 4.12 Front view of gripping unit

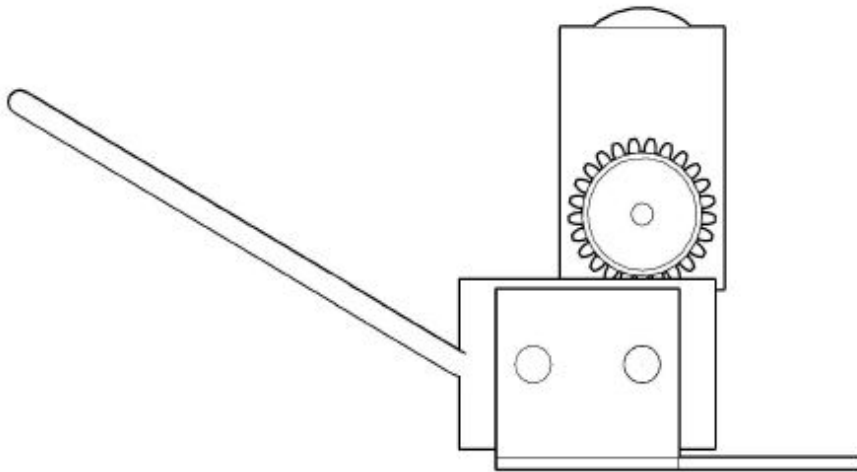

Fig. 4.13 Side view of gripping unit

4.4.2 Moving system or climbing system

The vertical unit or climbing unit for longitudinal movement consist of a v-shape supporting unit and a screw rod. One gripping unit was fitted at the end of climbing unit and other gripping unit was movable through threaded rod. A mild steel screw rod with 1 cm diameter was used and it was placed inside the v-section, one end of screw rod was fitted with a motor drive and another end was locked using lock nut.

Motor drive gives the up and down motion to the climbing unit and it was mounted at the top portion of climbing unit. The motor drive was transmitted to the screw rods through gears. A big gear with 6 cm pitch circle diameter was connected to the motor shaft directly. One small gear with 4 cm pitch circle diameter was connected to the screw rod and it was meshed with the big gear. The screw rod along with the v-shape chanal forms a moving/climbing unit. The 3D view if climbing unit with gripping units was presented in the Fig. 4.14.

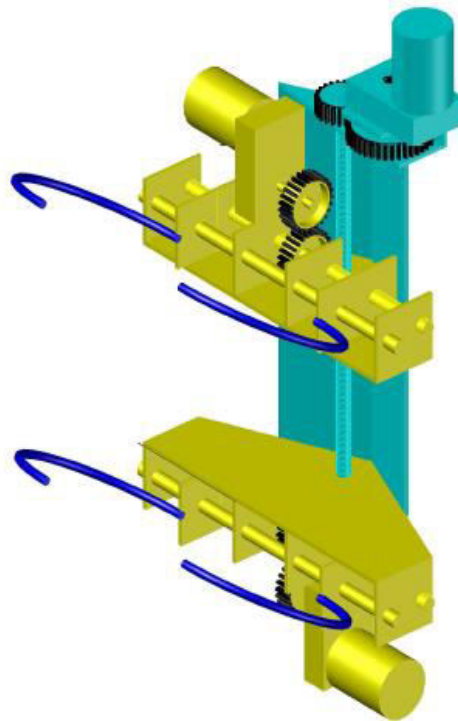

Fig. 4.14 Three dimensional view of climbing unit with gripping units

Table 4.12 Specifications of the screw rod

Screw thread	
Outer diameter	10 mm
Inner diameter	8.5 mm
Mean diameter	9 mm
Pitch	1.5 mm

Table 4.13 Specifications of the gears

Large gears	
Type	Spur gear
Addendum circle diameter	60.00 mm
Dedendum circle diameter	53.00 mm
Larger width of tooth	2.90 mm
Smaller width of tooth	1.30 mm
Thickness	12.00 mm
Number of teeth	38

Small gears	
Type	Spur gear
Addendum circle diameter	40.00 mm

Dedendum circle diameter	33.00 mm
Larger width of tooth	2.60 mm
Smaller width of tooth	1.20 mm
Thickness	12 .00 mm
Number of teeth	25

4.4.3 Motor

After analyzing the past works, it was decided to use three motors for achieving horizontal and vertical motion. Two motors (motor 1 and motor 2) were used for providing the horizontal (i.e. to and fro) motion to the two gripping units. Another motor (motor 3) was used for giving a longitudinal motion to the climbing unit. Based on the reviews, a 12 V DC motor which can produce a torque of 30 Kg.cm and a speed of 300 rpm was selected suitably for the design. The torque developed during the operation of the motor produces mechanical rotation and hence the motion.

Table 4.14 Specifications of the motor

Torque	30 Kg cm
Speed	300 rpm
Voltage supply	12 V
Type	DC

4.4.4 Control Unit

The control unit adopted for this design was a wired remote control system. The control unit consists of a switch panel, one main switch, and three turning switches, three on/off switches, led, resistor and diode. Diode was soldered to common PCB, and it influences the direction of current. LED was used for power indication and resistor was used for reducing the voltage. Ribbon wire connection was provided for the components.

A 12V DC supply was provided as a power source. When 12V DC supply reaches the turning push switch through main switch, turning push switches charges accordingly to the polarity requirement of 12V DC. Then the polarity charged and voltage reaches the on/off switch. On/off switch helps in stop and start the motor. Other two switches also worked in the same method.

4.4.5 Process of climbing

At the beginning, the power was supplied to the (Motor1) lower gripping unit; by the movement of both the arms it grabs/holds the tree. Then the power was supplied to the upper gripping unit (Motor 2). By that both the gripping units grabs the tree trunk tightly. After that, the lower arm releases the contact and moves up by the rotation of main motor (Motor 3). Then lower arm holds the tree trunk, upper arm releases and moves up. This process continues until the desirable height was reached. The arms hold the entire body during climbing. During climbing part of robot was always fixed to the tree trunk. The process of climbing was presented in the Fig. 4.15.

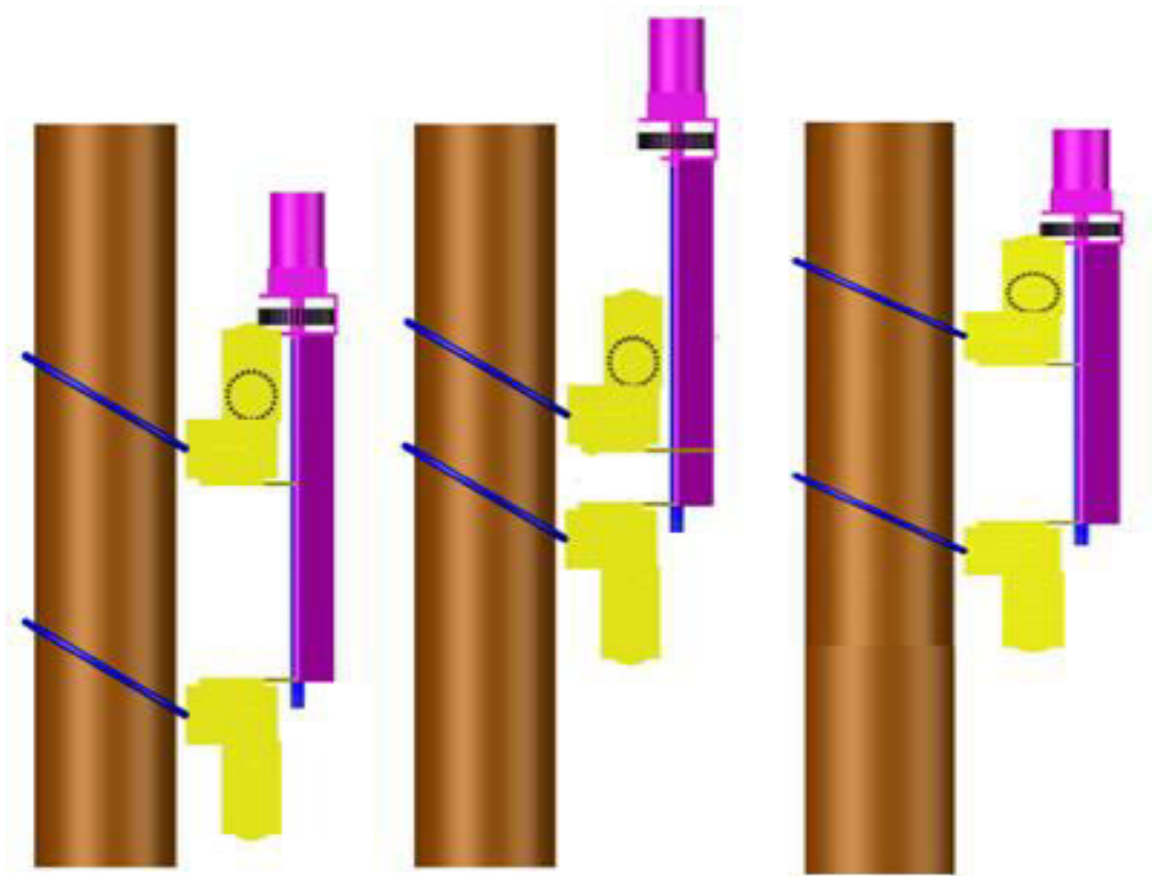

Fig. 4.15 Process of palm climbing

4.4.6 Testing of prototype

The developed prototype of the climber was tested in a laboratory set up and also in the farm. It was tested for different palms having varying trunk diameters and it suits well for the palms having diameter of 12-30 cm. This prototype climbs 15-20 cm in each step. The time taken for climbing was found more and it can be solved by using threaded rods of higher pitch value. Also, it was found that the climbing unit was capable of carrying the weight of 500 gm without failure.

Table 4.15 Specifications of Prototype 2

Weight	4.3 kg
Speed	0.25 m/min
Installation time	2-3 min
Suitable diameter range	12-30 cm
Ability to climb in each step	15-20 m
Load carrying capacity	500 gm

The disadvantage of the prototype is that the climbing process is slow. These disadvantages can be overcome by using screw rods of higher pitch value or by using hydraulic pistons instead of screw rod but the cost and weight of the product will increase drastically. By using hydraulic pistons instead of screw rods, the speed of climbing can be increased. But the system becomes more complex and expensive.

SUMMARY AND CONCLUSION

CHAPTER V

SUMMARY AND CONCLUSIONS

Palms are un-branched evergreen trees cultivated mainly for its nuts and one has to climb up the tree for harvesting and other operations like spraying. Considering the difficulty and drudgery involved in this operation different types of palm climbers were developed by researchers and innovators. These climbers essentially consist of two functional mechanisms, the clamping mechanism for gripping the unit to the trunk and climbing mechanism for vertical movement of unit. The gripping and climbing mechanisms used in different types of palm climbers and the biometric properties of areca palm which influence the design of palm climbers were studied as a part of this research work. A basic design for a semi-autonomous areca palm climber was evolved based on these studies. The summary of the results obtained from the experiments and the conclusions drawn out from the study were presented in this chapter.

A detailed prior art search related to the development and studies on tree and palm climbers related to mechanical and robotic climbers from 1967 to 2016 were collected and reviewed to understand different mechanisms used in climbers and the changes or improvements incorporated in due course of time. The collected reviews from various resources were categorized based on the mechanisms used, suitability for different palms and merits and demerits etc.

The developed palm climbers can be categorized based on the type of motion of the unit, the power utilized for actuating the functional components and the mechanism deployed for the actuating functional components. The motion of the climber on trunk of palm was either of continuous, discrete or serpentine. In the continuous type, the relative position of all the components of the unit with respect to a point on trunk will be always changing with time. Palm climbers with discrete type of motion essentially comprise of two sets of similar functional components. In this type, any one set of component of the unit will always be

fixed to the trunk of the tree. Serpentine motion is also a continuous motion. The unit takes S- shape or spiral movement over the tree trunk.

The palm climbers can further be categorized based on the power utilized. Design which uses human power can be mainly termed as mechanical palm climbers. These are essentially man positioners which takes human to the top of the tree. Mechanical climbers can be further classified as standing type or sitting type based on how the operator was positioned in the climber. The other category based on power utilized was robotic climbers, which are powered by DC motors. These are normally unmanned climbing units which will take the harvesting tool or any other required attachment to the top of the tree. These robotic climbers can further be classified based on the mechanisms by which the unit is held to the trunk, i.e. as grasping mechanism or adhesion mechanism.

The standing type climbers utilizes two climbing mechanisms, by placing the arms around the tree or by holding the rectangular frame using hands and pulling up the base plate with the feet. The tree climbing and hunting platform developed by Baker and Walter in 1969 may be considered as the base model for this type and the later versions are developed by modifying, altering or incorporating additional components. Another mechanism commonly used was lifting and raising the unit by hand and foot. The palm climber developed by Appachan in 2002 for coconut and arecanut can be considered as the pioneer work of this type. Further developments in mechanical climbers were based on this climber with improvements in terms of clamping mechanisms, materials and structural components, safety consideration etc.

From the literature, it was found that the first sitting type climbing device was developed in 1976 by Cotton. It consists of v-shape tree engaging bars to grip the platform to the tree surface. The climbing was done by sitting on the upper platform and lifting the lower platform by hand and standing on the lower platform and sliding the upper platform by hand which may be considered as the base model for other sitting type devices developed after this device. This model

was modified by the many researchers in terms of gripping, climbing, safety and weight.

The biometric properties of Areca palm were studied by randomly selecting twenty trees at KCAET farm. Among the quantifiable biometric properties of areca palms, diameter of the palm, height of the palm, variation of diameter along the length, and tilt angle were identified as the major properties which influence the design and performance. Data related to these properties were recorded for every one meter interval of areca palm till 9 m height. It was observed that, the trunk diameter of areca palm is the most important parameter which influences the design of areca palm climber. The size of gripping unit, shape and dimensions of gripping arms or structures, their spacing and the distance through which the gripping arms are to be moved for locking and unlocking can be properly assessed only with adequate data and knowledge on diameter.

Two diameters corresponding to maximum (D_{Max}) and minimum (D_{Min}) were taken for a particular position. The diameter (D_{Cir}) was also estimated by measuring the circumference of the trunk at that position. The maximum and minimum diameters among D_{Max} and D_{Min} were 175 mm and 76 mm respectively. The maximum and minimum of D_{Cir} was observed as 181 mm and 80 mm respectively.

The average (D_{Ave}) of D_{Max} and D_{Min} was calculated and compared with diameter estimated by measuring the circumference (D_{Cir}). It is also observed that D_{Cir} gives a value more than the D_{Ave} in all the cases. The higher value of D_{Cir} compared to D_{Max} or D_{Ave} may be due to undulations present on the trunk along the circumference. The difference between the D_{max} and D_{min} were calculated to analyse the variation on diameter along circumference. It is observed that the variation is in range ± 5 mm. The variation in diameters along the circumference in the bottom 5 m and next 4 m were also compared. This also showed the same pattern as the total variation. The variation of diameter along the circumference was negligible which indicates that there are no major undulations among the

circumference of the trunk. Considering these factors and pattern of gripping arms used in clamping mechanisms it can be concluded that diameter, estimated based on the measurement of circumference (D_{Cir}) gives a better indication of the diameter of the trunk of palm for the design.

The diameter of the trunk of the palm is reducing with height from ground. The change in diameter from 1 m above the ground to 9 m was studied and it was seen that the maximum and minimum changes were 92 mm and 26 mm respectively. The maximum and average variation of diameter in one meter height increase noticed was 38 mm and 5.5 mm.

In order to study the straightness of trunk a regression analysis of height and diameter was done. The R^2 values obtained were between 0.88 and 0.99 which indicates that there is a linear relationship between the height and diameter data or in other words it can be concluded that the trunk is almost straight. The diameters of palm at the top portions were predicted by regression analysis using linear equation and known values of diameter up to five meters from the bottom of the palm. The variation between the predicted and observed values of diameters were noticed ranging from -0.085 mm to 5 mm, which shows that the prediction gives a reasonably reliable estimate of the diameter.

The height of palm does not directly influence the design of the climber; it is a major parameter which affects the operation of the robotic climbers. The time required for completing the climbing is directly influenced by the height and when height increases, it will be difficult to see and operate the climber from the ground. The minimum and maximum height observed were 9 m and 22 m respectively. The diameter at 1 m height from ground and the height of the palm was studied to see whether there is any relationship between the height and base diameter. It was observed that the base diameter is comparatively smaller for trees having more height. A 9 m height of areca palms have an average diameter of 17.18 cm and a height of 22 m palm have a diameter of 13.05 cm. The tilt angle of areca palm was also observed during the study. The results of the study showed that, the maximum number of palms has a tilt of 1 to 2 and 2 to 3 degrees. The

obtained tilt angle was very less so, it might not affect the design of robotic areca palm climber.

Based on all these biometric properties, a semi-autonomous climber was developed for climbing areca palm. A semi-autonomous climber was designed with basic components like gripping unit, climbing unit. Based on the review of different models of climbers, it was found that different types of gripping systems were used the most common being; linear actuator mechanism, active wheels with spring interlock mechanism, suction cups, jaws and claws. From these mechanisms the power screw mechanism was selected for gripping the unit to the trunk. Reviews on climbing mechanism indicated that different types of mechanisms were utilized effectively. The mechanisms include actuators like pneumatic jacks, linear actuators or screw mechanism, X-bar mechanism, wheel mechanism and continuum body mechanism. From these mechanisms the screw mechanism was selected for climbing the unit along the trunk of the tree.

The preliminary prototype was designed, fabricated and its functionality was tested. The designed climber has two components, one is gripping unit which will provide to and fro motion to the gripping arms hence the arms grabs the tree. Another component is climbing unit which will provide up and down movement hence the climbing happens. At the beginning, the power was supplied to the lower gripping unit, by the movement of both the arms it grabs/holds the tree. Then the power was supplied to the upper gripping unit. By that both the gripping units grabs the tree trunk tightly. After that, the lower arm releases the contact and moves up by the rotation of main motor. Then lower arm holds the tree trunk, upper arm releases and moves up. This process continues until the desirable height was reached. The arms hold the entire body during climbing. During climbing part of robot was always fixed to the tree trunk. The fabricated climber was tested with various areca palms having varying trunk diameters and it suits well for the palms having diameter of 12-30 cm. This prototype climbs 15-20 cm in each step. Also, the climbing unit was capable of carrying the weight of 500 gm without failure.

REFERENCES

REFERENCES

- [Anonymous]. 2008. Tree climbing robot. <https://www.youtube.com/watch?v=.XI0CR67g6ww>.
- [Anonymous]. 2010. www.agritech.tnau.ac.in, retrieved on 22nd Oct. 2010.
- [Anonymous]. 2011. How to calculate tree height using a smartphone. <https://gabrielhemery.com/2011/05/15/how-to-calculate-tree-height-using-a-smartphone/>.
- [Anonymous]. 2011. Areca palm climber. <https://www.youtube.com/watch?v.=ECVxeCofvbs>.
- [Anonymous]. 2011. Tree Climbing Robot by IEST, Shibpur. https://www.youtube.com/watch?v=_SXoyI1CNag.
- [Anonymous]. 2012. Measurement of tree diameter. New Mexico State University FFA Forestry and condensed tree measurement for Ordway (Macalester College). EREN PFPP Version 1.05.
- [Anonymous]. 2014. Agricultural statistics at a glance 2014 & Indian horticulture database 2014, Ministry of Agriculture, Government of India.
- [Anonymous]. 2016. Coconut tree climbing machine. <https://www.youtube.com/watch?v=IuE4BuRyNI>
- [Anonymous]. 2016. An analytical study on agriculture in Kerala, Govt. of Kerala. http://www.keralaagriculture.gov.in/pdf/a_s_06042016.pdf.
- Appachan, J. A. 2002. Device to climb arecanut or coconut tree: Second National Grassroots Technological Innovation and Traditional Knowledge Awards. *National Innovation Foundation- India*.

- Asfar, K. R. 2016. Palm tree climbing robot. *J. Automat. Control Eng.* 4(3): 220-224.
- Baghani, A., Ahmadabadi, M. N., and Harati, A. 2005. Kinematics modelling of a wheel-based pole climbing robot (UT-PCR). In: Proceedings of the 2005 IEEE International Conference on 18-22th April 2005. ISSN: 1050-4729 DOI: 10.1109/ROBOT.2005.1570423.
- Baker, E. J. and Walters, L. F. 1969. Tree climbing-hunting platform. US patent-3460649. <http://www.google.co.in/patents/US3460649>.
- Basavaraja, J. S., Nagaraja, R., and Hegde, S. H. 2015. Design and development of areca tree climber. *Int. J. Res. Mech. Automob. Eng.* 1(2): 83-90.
- Bragg, D. C. 2008. An improved tree height measurement technique tested on mature southern pines. *South. J. Appl. For.* 32(1):38-43.
- Chave, J. 2005. Measuring tree height for tropical forest trees: A Field Manual. Pan-Amazonia Project.
- Christenhusz, M. J. and Byng, J. W. 2016. The number of known plants species in the world and its annual increase. *Phytotaxa*. Magnolia Press. 261(3): 201-217.
- Cotton, C. W. 1976. Tree climbing device. US patent- 3960240. <https://www.google.com/patents/US3960240>.
- Dubey, A. P., Pattnaikb, S. M., Banerjee, A., Sarkard, R., and Saravanakumar R. E. 2016. Autonomous control and implementation of coconut tree climbing and harvesting robot. International Conference on Computational Modeling and Security (CMS 2016). *Procedia Computer Science* 85:755 – 766.
- Edachari, D., Kumar, S., Unakal, P. 2011. Design of a coconut tree climbing device. *Sas Tech.* 10(2). 87-90.

- Elzinga, C., Shearer, R. C., and Elzinga, G. 2005. Observer variation in tree diameter measurements. *West. J. Appl. For.* 20(2):134 –137.
- Erbil, M. A., Prior, S. D., Karamanoglu, M., Odedra, S., Barlow, C., Bell, J., and Brazinskas, M. 2011. Design and development of a pole climbing surveillance robot. In: Nz Rapid Product Development Conference. February 7-8, Auckland University Of Technology, Auckland, New Zealand.
- Fengyu, X., Jingjin, S., and GuoPing, J. 2015. Kinematic and Dynamic Analysis of a Cable-climbing Robot. *Int. J. Adv. Robotic Syst.* doi: 10.5772/60865.
- Gardner. 1992. Climbing palm stand, US Patent- 5156236. <http://www.google.co.in/patents/US5156236>.
- Gostanian, J., Read, E., and Michael, A. 2012. Design and construction of a tree-climbing robot. Worcester Polytechnic Institute.
- Graham, Thomas, E., Graham, Thomas, E., Graham, and Christopher, L. 2003. Adjustable palm stand. US Patent- 6668976B2. <https://www.google.com/patents/US6668976>.
- Hariskrishna, T. V., Harshavardhan., and Pandey, V., 2014. Design of climbing mechanism for a tree climbing robot. *Int. J. Curr. Eng. Technol.* (3):85-88.
- Hariskrishna, T. V., Pandey, V., and Harshavardhan. 2013. Design of climbing mechanism for a tree climbing robot. *Int. J. Mech. Eng. Res.* (2):747-654.
- Harley B. R. 1967. Combination tree stand and game cart. US patent- 3352379. <http://www.google.co.in/patents/US3352379>.
- Hegde, S. A. and Deal, J. 2014. Arecanut farming in south India: A case study. *Int. J. Business Social Sci.* 5(10):40-45.

- Horace. 1985. Palm climbing apparatus. Patent storm. US Patent 4549633.
<http://www.google.co.in/patents/US4549633>.
- Hugar, H., Kadewadi, P., Kazi, Z., Kotwal, Z., and Kannur, N. S. 2013. Design and fabrication of coconut tree climbing equipment. Project reference no: 38S0308.
- Jacob, E. and Haridasan, V. P. 2015. Development of an autonomous tree climbing robot. In: proceedings of 22nd IRF International Conference. 29th March 2015, Chennai. India. ISBN: 978-93-82702-83-2.
- Jaikumaran, U., Joseph, S., Preman, P. S., Unnikrishnan, C. Jitha, K. J. and Joseph, C. J. 2016. Design and development of sitting type coconut palm climbing device - "Kera Suraksha Coconut Climber". *J. Trop. Agr.* 54 (1): 136-143.
- Jain, A., 2010. Tree climber. <http://www.umic-iitb.org/tree-climber.pdf>.
- Jawaharlal, M. 2010. Coconut tree climbing device. www.nciia.org, retrieved on 22nd Oct. 2010.
- Joseph, W. M. 1976. Tree climbing stand. US patent- 3944022.
<https://www.google.ch/patents/US3944022>.
- Joseph. 2006. Making man reach the moon: Top of palm. Honey bee. Vol 17(1) & (2):14.
- Kawasaki, H., Murakami, S., Kachi, H., and Ueki, S. 2008. Novel climbing method of pruning robot. In: *SICE Annual Conference*. August 20-22. The University Electro-Communications, Japan.
- Kawasaki, S. and Kikuchi, K. 2014. Development of a small legged wall climbing robot with passive suction cups. In: The 3rd International Conference on Design Engineering and Science, ICDES 2014. Pilsen, Czech Republic, August 31 – September 3, 2014.

- Kennedy, B., Oken, A., Aghazarian, H., Badescu, M., Bao, X., Cohen, Y. B., Chang, Z., Dabiri, B. E., Garrett, M., Magnone, L., and Sherrit, S. 2005. "Lemur Iib: a robotic system for steep terrain access" – California.
- Lam, T. L. and Xu, Y. 2011. Climbing strategy for a flexible tree climbing robot—Treebot. *IEEE Transactions on Robotics*. 27(6).
- Louk J. M., Brewer, A. and Fuller, R. J. (1999). Convertible palm stand for rifle/bow use. US Patent -5921348.
- Louk. 1993. Palm stand. US Patent- 5234076. <http://www.google.co.in/patents/US5234076>.
- Mani, A. and Jothilingam, A. 2014. Design and fabrication of coconut harvesting robot COCOBOT. *Int. J. Innov. Res. Sci., Eng. Technol.* 3 (3): 1351-1354.
- Mathew, A. C. and Krishnan, M. V. 2015. Coconut and arecanut palm climbing device. Indian patent-268548. <http://www.allindianpatents.com/patents/268548-coconut-and-arecanut-palm-climbing-device>
- Megalingam, R. K., Pathmakumar, T., Venugopal, T., Maruthiyodan, G., and Philip, A. 2015. DTMF based robotic arm design and control for robotic coconut tree climber. In: *IEEE International Conference on Computer, Communication and Control (IC4-2015)*.
- Megalingam, R. K., Venumadhav, R., Pavan, K. A., Mahadevan, A., Kattakayam, T. C., and Menon, T. H. 2013. Kinect based wireless robotic coconut tree climber. In: *Third International Conference on Advancements in Electronics and Power Engineering*; 8-9, January, 2013, kuala lumpur. PP: 201-206.
- Menon, C., Murphy, M., and Sitti, M. 2009. Gecko inspired surface climbing robots. *IEEE*. PP: 1-6.

- Mittal, R., Dave, S., Korpu, R., Varada, V. R., Khanna, A., and Tilak, S. 2014. Semi-autonomous arecanut tree climbing robot. In: 9th international conference; 5-17, December, 2014, Gwalior.
- Morris. 2002. Climbing palm stand. US Patent- 6345690B1. <https://www.google.ch/patents/US6345690>.
- Nallusamy, V., Shrivathsan, N., Vinoop, U., Satish, M., and Yashwanth. N. G. 2015. Tree climbing robot (Treebot). *J. Electr. Sci. Technol.* 4(4): 9-13.
- Orwa, C., Mutua, A., Kindt, R., Jamnadass, R. S. and Anthony. 2009. Agro forest tree Database: a tree reference and selection guide version 4.0. (<http://www.worldagroforestry.org/sites/treedbs/treedatabases.asp>).
- Peter, S., Jayanth, M., Babu, M. K., Ashida, P. V., and Akhil, K. T. 2015. Design and construction of a tree climbing robot. *Int. J. Adv. Res. Electr. Electr. Instrum. Eng.* 4(4): 2423-2429.
- Powell, D. C. 2005. How to measure a big tree. Umatilla National Forest. Pendleton.
- Prasad, A., Varghese, T., Varghese, T. T., and Skariah, E. N. 2016. Wireless palm tree harvester. *Int. J. Adv. Res. Electr. Electron. Instrum. Eng.* 5(3): 2320 – 3765.
- Raj, D. P., and Nayak, D., 2014. Design and development of wall climbing robot. Department Of Industrial Design. *National Institute Of Technology. Rourkela*.
- Rahul, V., Babu, S., Moideen, S., Vineeth, V. P., and Ninan, N. 2015. Semi-automated coconut tree climber. *Int. J. Res. Eng. Technol.* 4(3):532-539.
- Raj, B. A., Parthiabn, K. S., Praveen, R. B., Vignesh, K., and Lalita, B. 2015. Semi-autonomous coconut harvesting robot. *Int. J. Recent Technol. Mech. Electr. Eng.* 2(10):67-71.



- Ramappa, B. T., (2013). Economics of Areca nut cultivation in Karnataka, a case study of Shivamogga district. *IOSR J. Agri. Veter. Sci.* (IOSR-JAVS) e-ISSN: 2319-2380, p-ISSN: 2319-2372. 3(1):50-59.
- Reggin. 1994. Portable palm stand assembly. US Patent-5316105. <http://www.google.tl/patents/US5316105>.
- Sadeghi, M. and Moradi, A. 2008. Design and fabrication of a column-climber robot (Koala Robot). *Int. J. Mech., Ind. Aerospace Eng.* 2(4):656-661.
- Sajeevkumar, V. 2011. Mechanical coconut climbing device. 20th march 2011. <http://www.thehindubusinessline.com/economy/agri-business/new-mechanical-coconut-climbing-device-developed/article1556239.ece>
- Saltaren, R., Aracil, R., Reinos, O., and Yime, E. 2007. Climbing with parallel robots. Open Access Database www.i-techonline.com: 209-226.
- Senthilkumar, S. K., Srinivas, A., Kuriachan, M., Sibi, S. M., Veerabhadhran, Vinod, B., and Ganesh, C. S. 2015. Development of automated coconut harvester prototype. *Int. J. Innov. Res. Sci., Eng. Technol.* 4(8):7134-7140.
- Shenoy, K. C., Rayan, L., Arpith, and Raghuvveera, H. 2014. Remote controlled tree climbing machine for tree. Project Reference No.: 38S154.
- Shokripour, H., Ismail, W. I., and Moezkarimi, Z. 2010. Development of an automatic self-balancing control system for a tree climbing robot. *Afr. J. Agric. Res.* 5(21): 2964-2971.
- Shokripour, H., Ismail, W. I., Shokripour, R., and Moezkarimi, Z. 2012. Development of an automatic cutting system for harvesting oil palm fresh fruit bunch. *Afr. J. Agric. Res.* 7(17): 2683-2688.
- Stuart. 1997. Palm stand shroud. US Patent-5617932. <http://www.google.si/patents/US5617932>.

- Subramanyam, A., Mallikarjuna, Y., Suneel, S., and Kumar, L. B., 2015. Design and development of a climbing robot for several applications. *Int. J. Adv. Computer Technol.* 3(3): 15-23. ISSN: 2319-7900.
- Tony, M., Johny, C., Sayooj, S., Yathish, K., Vas, J. P., 2016. Design and fabrication of arecanut tree climbing and spraying machine. *J. Mech. Eng. Automat.* 6(5): 93-96.
- Veeresh, M. L., Ramakrishna, D. S., Shashidhar, K. C., Basavarajappa, H. B. 2016. Development of areca tree strength testing device and strength evaluation of the tree. *Int. J. Adv. Engg. Technol. Manag. Appl. Sci.* 3(1):151-156.
- Venkat, D. N. 2012. Multi tree climber. National innovation foundation India. nif.org.in/innovation/coconut_tree_climber/471.
- Wang, J. A. and Chen, W. W., 2012. Method for measuring angles of tilt trees. http://a-a-r-s.org/acrs/administrator/components/com_jresearch/files/publications/SC01-0502.pdf
- Widanagamage, B. C., Gallege, T. N., Salgado, S., and Wijayakulasooriya, J. 2014. TREEBOT: An autonomous tree climbing robot utilizing four bar linkage system. *SAITM Res. Symp. Eng. Advmt.* 181-185.
- Williams. 1989. Combined climbing and hang-on palm stand with optional climbing aid. US Patent -4802552.



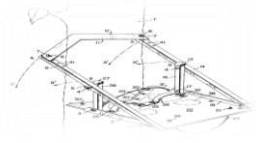
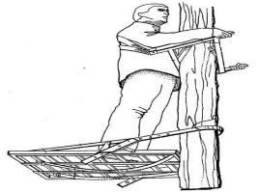

APPENDICES

Appendix I

Standing type mechanical climbers

Sl. No.	Name	Clamping and Climbing Mechanism	Features	Figure
Mechanism: Rectangular frames and foot				
1	Tree climbing and hunting platform (Baker and Walter, 1969)	Clamping: V- shape blade extending from rear edge of the plate Climbing: By placing arm around the tree and pulling up the platform by feet	The plate present in this device was self-supporting and it was in raised position so, the weight of the person was distributed over the plate	
2	Hang on type palm climbing aid (Williams, 1989)	Clamping: Rectangular frames with adjustable lock Climbing: By raising the upper platform using hands and lifting the lower platform by foot	Adjustable lock was provided so, it can be used for the tree having varying diameters	
Mechanism: Steel wires and foot				
3	Tree climbing device (Appachan, 2002)	Clamping: Metal wire loops Climbing: By the movement of hand and foot	It can be used for coconut palm, arecanut or other similar trees and also used to climb electric poles with some modifications	

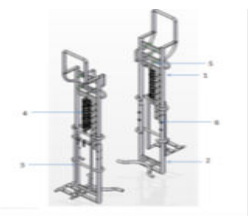
Appendix I continued.



4	Standing Type Climbing Device (Jawaharalal, 2010)	Clamping: Steel rope wires Climbing: By the movement of hand and foot	There is no support for the body while climbing so it may cause fatigue to the person who climb the tree	
5	Design of a coconut tree climbing device (Edacheri <i>et al.</i> , 2011)	Clamping: Steel rope wires Climbing: By the movement of hand and foot	Flat foot rest and safety belts were provided. Safety belt was adjustable as per the proper body posture	
6	Design and fabrication of coconut tree climbing equipment (Hugar <i>et al.</i> , 2013)	Clamping: Steel rope wires Climbing: By the movement of hand and foot	<ul style="list-style-type: none"> • Equipment height can be altered according to the convenience of user • Easy to dismantle by removing the locking screws and easy to transport • The structure was able to carry a load of 100kg 	
7	Design and Development of Areca Tree Climber (Basavaraja <i>et al.</i> , 2015)	Clamping: Steel rope wires Climbing: By the movement of hand and foot	<ul style="list-style-type: none"> • Maximum height of 40 feet was climbed with an average of 15-20 trees was harvested/sprayed by climbing • Simple and efficient design 	

Appendix II

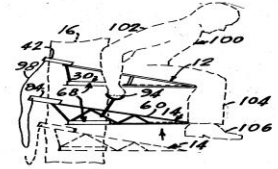
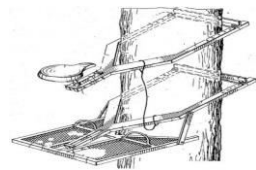
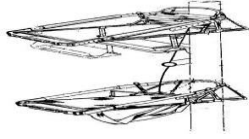
Sitting type mechanical climbers

Sl. No.	Name	Clamping and Climbing Mechanism	Features	Figure
Mechanism: Steel bars/ frames and hands				
1	Tree climbing device (Cotton, 1976)	Clamping: V- shape tree engaging bars Climbing: By lifting upper and lower platforms by hand	Both upper and lower platforms have adjustable tree engaging frames	
Mechanism: Steel bars/metal frames (Rectangular, U shape, V shape and Y shape) with hand and foot				
2	Palm climbing apparatus (Horace, 1985)	Clamping: Metal frames Climbing: By raising upper platform by hand and lower platforms by foot	<ul style="list-style-type: none"> Used for palms having straight tree trunk A seat was presented on upper platform 	
3	Climbing palm stand (Gardner, 1992)	Clamping: Two adjustable frames Climbing: By raising upper platform by hand and lower platforms by foot	Used for palms having straight tree trunk	

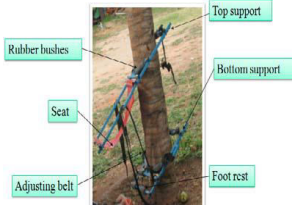

Appendix II continued.

4	Sitting type climbing device (TNAU) (Anonym, 2010)	<p>Clamping: Two metal frames with rubber bushes</p> <p>Climbing: Upper frame is to be lifted by hand and lower frame is to be lifted by foot</p>	<ul style="list-style-type: none"> • Safety belts were provided and it can be adjustable to the body posture of user • weight of the device was approximately 9 kg 	
5	Mechanical coconut climbing device (Sajeevkumar, 2011)	<p>Clamping: U- frames with rubber bushes</p> <p>Climbing: By raising the upper frame by hand and lifting the lower frame by foot</p>	<ul style="list-style-type: none"> • It weighs of about 8.4 kg • It can lift maximum weight of 400 kg • It takes about 40 sec to safely climb a palm tree having a height of 12m • It gives safety and security to the climber 	
6	Multi tree climber (Venkat, 2011)	<p>Clamping: Two metal frames with rubber bushes</p> <p>Climbing: By raising the upper frame by hand and lifting the lower frame by foot</p>	<ul style="list-style-type: none"> • Locking mechanism was provided so; the user can work without fear • Low cost 	

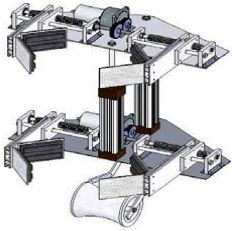

Appendix II continued.

7	Coconut and arecanut climbing device (Mathew and Krishnan, 2015)	Clamping: U shape metal frames with rubber bushes Climbing: By raising the upper frame by hand and lifting the lower frame by foot.	<ul style="list-style-type: none"> • Laminated U- shape frames with rubber were used to get good grip • A provision for fixing a pair of shoes of climber size 	
Mechanism: Steel ropes with hand and foot				
8	Coconut climbing machine (Kara Suraksha Coconut Climber) (Jaikumaran <i>et. al.</i> , 2016)	Clamping: Steel wire ropes Climbing: By raising the upper frame by hand and lifting the lower frame by foot.	Fastening can be adjusted even while operating the machine according to the girth of the palm	

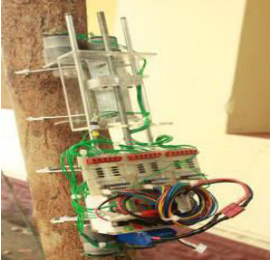

Appendix III
Robotic climbers

Sl. No.	Name	Clamping and Climbing Mechanism	Features	Figure
Screw Mechanisms				
1	Design and Fabrication of a Column Climber Robot (Sadeghi and Moradi, 2008)	Clamping: Screw mechanism Climbing: Pneumatic jacks	<ul style="list-style-type: none"> • Installation time on column- 8sec • Force exerted to the column- 400N • It can climb pipe having diameter of 10-30cm • Weight- 12kg, Speed- 2cm/sec and it can able to climb 15cm in each step 	
2	Tree climber (Jain, 2010)	Clamping: Rubber over a hollow tubes Climbing: Screw mechanism	<ul style="list-style-type: none"> • Used to climb straight trees 	
3	Treebot: an autonomous tree climbing robot utilizing four bar linkage system (Widanagamage <i>et al.</i> , 2014)	Clamping: Four bar linkage system Climbing: Screw mechanism	<ul style="list-style-type: none"> • Suitable for 15-25cm diameter trees • Weight of device was 4.367kgs 	



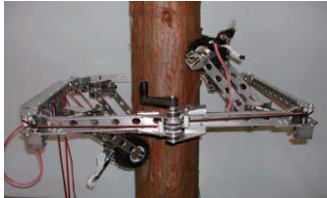
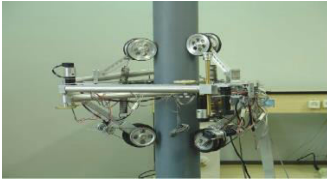

Appendix III continued.

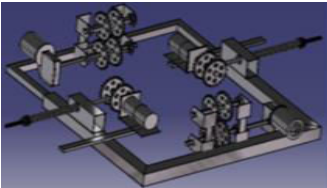
4	Semi-Autonomous Tree-Climbing Robot (Mittal <i>et al.</i> , 2014)	Clamping: Four bar linkage system Climbing: X-bar mechanism	Used to climb Areca palms	
5	Design and Construction of a Tree Climbing Robot (Peter <i>et al.</i> , 2015)	Clamping: Four legs with very sharp points as feet (Claws) Climbing: Screw mechanism	<ul style="list-style-type: none"> • It can be used for harvesting tree and observation of tree dwelling animals • Suitable for trees having diameter of 10-20cm • Used for branchless trees • Load carrying capacity was 0.75kg • It can able to climb half meter in 8min 	
6	Autonomous control and implementation of coconut climbing and harvesting robot (Dubey <i>et al.</i> , 2016)	Clamping: Screw mechanism Climbing: Screw mechanism	<ul style="list-style-type: none"> • Low cost • Slow in climbing • Climbing fails if there is misalignment in thread rod and nut 	



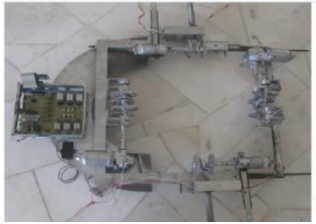

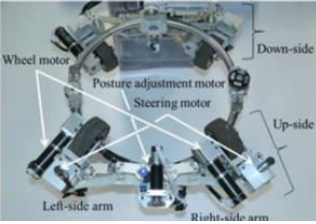
Appendix III continued.

Wheel mechanism				
7	Novel Climbing Method of Pruning Robot (Kawasaki <i>et al.</i> , 2008)	Clamping: Four active wheels were set at regular intervals around the tree, which one pair for upper side and the other for lower side. Climbing: Wheels with servo motors	<ul style="list-style-type: none"> • Light weight and speed in climbing • Diameter of tree varies from bottom to top of tree which affects the robot configuration 	
8	Kinematics Modelling of a Wheel-Based Pole Climbing Robot (UT-PCR) (Baghani <i>et al.</i> , 2010)	Clamping: Four active wheels were set at regular intervals around the tree, which one pair for upper side and the other for lower side. Climbing: Wheels with servo motors	<ul style="list-style-type: none"> • Slipping of wheels • Free and uncontrolled motion 	
9	Design and Development of a Pole Climbing Surveillance Robot (Erbil <i>et al.</i> , 2011)	Clamping: It employs two wheels with 14 permanent magnets. Climbing: Wheels with motors	<ul style="list-style-type: none"> • Used to climb columns or palms 	
10	Development of an automatic self-balancing control system for a tree climbing robot (Shokripour <i>et al.</i> , 2010)	Clamping: Grip designed wheels were used for clamping Climbing: Wheels with motors	<ul style="list-style-type: none"> • Total maximum tilt was 6 and 8degrees • It can able to climb 4.6m/min 	



Appendix III continued.

11	Development of an automatic cutting system for harvesting oil palm fresh fruit bunch (Shokripour <i>et al.</i> , 2012)	Clamping: Grip designed wheels were used for clamping Climbing: Wheels with motors	<ul style="list-style-type: none"> • Vibrations while climbing • Total weight of robot with cutting system – 18.5kg 	
12	Hexagonal Wired Remote Controlled Fixed Ground Station Model (Cocobot1) (Megalingam <i>et al.</i> , 2013)	Clamping: Grippers are added to the wheels helps to clamp the tree. Climbing: Wheels with motors	Used to climb coconut palm	
13	Climbing robot equipped with a postural adjustment mechanism for conical poles (Megalingam <i>et al.</i> , 2015)	Clamping: Grippers are added to the wheels helps to clamp the tree. Climbing: Wheels with motors	Used to climb columns or poles	
14	Remote controlled tree climbing machine for tree (Shenoy <i>et al.</i> , 2014)	Clamping: Square frame with springs Climbing: Wheels with motors	Used to climb areca palms	

Appendix III continued.

15	Design and Fabrication of Coconut Harvesting Robot: COCOBOT (Mani and Jothilingam, 2014)	Clamping: An octagon shaped chassis with four active wheels were set at specific intervals around the tree. Climbing: Wheels with motors	Used to climb coconut palms	
16	Development of an autonomous tree climbing robot (Jacob and Haridasan, 2015)	Clamping: Two arms having wheels with a spring type interlock system, this helps to lock the tree. Climbing: Wheels with motors	<ul style="list-style-type: none"> Autonomously climb the tree even if there is any irregularity Slow and there is a possibility of damaging the tree trunk 	
17	Development of Automated Coconut Harvester Prototype (Senthilkumar <i>et al.</i> , 2015)	Clamping: Triangle frame with three frames and springs Climbing: Wheels with motors	<ul style="list-style-type: none"> Used for varying diameter tree Weight 5kg 	
18	Kinematic and Dynamic Analysis of a Cable-climbing Robot (Fengyu <i>et al.</i> , 2015)	Clamping: Two driven wheels were independently supported with a spring. Climbing: Wheels with motors	<ul style="list-style-type: none"> The robot can take a load of 3.9kg Maximum driving torque 8Nm 	 <p>(c) Experiments when climbing an obstacle</p>
19	Design and fabrication of arecanut tree climbing and spraying machine (Toney <i>et al.</i> , 2016)	Clamping: Two driven wheels were independently supported with a spring. Climbing: Wheels with motors	<ul style="list-style-type: none"> Smooth climbing Climbing mechanism and spraying unit working accordingly to the requirement 	

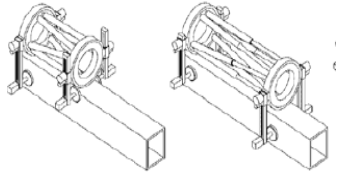

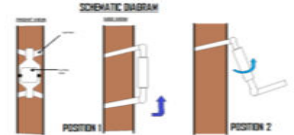

Appendix III continued.

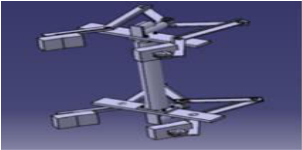
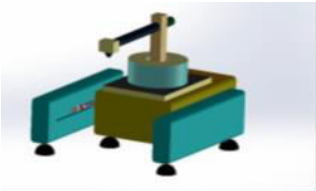
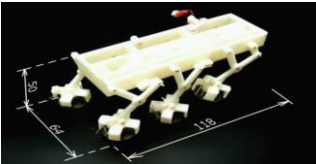
20	Wireless palm climber (Prasad <i>et al.</i> , 2016)	Clamping: Two driven wheels were independently supported with a spring. Climbing: Wheels with motors	<ul style="list-style-type: none"> • Used for areca palms 	
Linear actuating mechanism				
21	Climbing with parallel robots (Saltarén <i>et al.</i> , 2007)	Clamping: Rings with radial gripping devices were used for clamping. Climbing: Linear actuators	<ul style="list-style-type: none"> • It can climb at a speed of 0.6m/sec • Necessary to develop a maximum force of 1120N • Simple, robust and less dead weight 	
22	Design and Construction of a Tree-Climbing Robot (Gostanian <i>et al.</i> , 2012)	Clamping: Claws were used to clamp the tree. Climbing: Linear actuators	<ul style="list-style-type: none"> • Used for coconut palms 	
23	Design of Climbing Mechanism for a Tree Climbing Robot (Harikrishna <i>et al.</i> , 2013)	Clamping: Claws with torsional springs were used for clamping. Climbing: Linear actuators	<ul style="list-style-type: none"> • Used for straight trees • Used for small coconut trees 	

Appendix III continued.

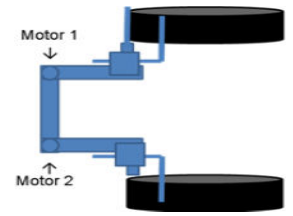
24	Semi-automated coconut tree climber (Rahul <i>et al.</i> , 2015)	Clamping: Two angular links, two arms, two straight links and a linear actuator Climbing: Electrical linear actuator	<ul style="list-style-type: none"> • Each actuator can carry up to 400kg 	
25	Design and development of wall climbing robot (PrudviRaj and Nayak, 2014)	Clamping: Suction cups were used for clamping Climbing: Rack and pinion mechanism	<ul style="list-style-type: none"> • Wall cleaning for high raising buildings • Operated to climb a glass wall • Public safety and military applications 	
26	Tree Climbing Robot by IIEEST, Shibpur (you tube)	Clamping: Aluminium sheets were used for holding on to the trunk of tree. (claws) Climbing: Rack and pinion mechanism	Used to climb trees	
27	Development of a Small Legged Wall Climbing Robot with Passive Suction Cups (Kawasaki and Kikuchi, 2014)	Clamping: Aluminium sheets were used for holding on to the trunk of tree. (claws) Climbing: Rack and pinion mechanism	Used to climb Walls	

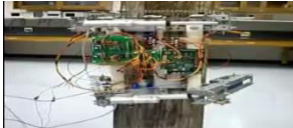
Appendix III continued.

Continuum body Mechanism				
28	Semi-Autonomous Coconut Harvesting Robot (Raj <i>et al.</i> , 2015)	Clamping: Rubber over an aluminium rod provides a better gripping Climbing: continuum body	<ul style="list-style-type: none"> • It can climb irregular shaped trees with branches • It was designed to be more intelligent with increased locomoting speed 	
29	Areca palm climber (you tube)	Clamping: Square frame with claws helps in climbing Climbing: continuum body	<ul style="list-style-type: none"> • Used to climb arecanut palms 	
30	Tree climbing robot (you tube)	Clamping: Claws Climbing: continuum body	<ul style="list-style-type: none"> • Used to climb straight trees 	
31	Coconut tree climbing machine (you tube)	Clamping: Metal bars with small rubber bushes helps in clamping Climbing: Continuum body	<ul style="list-style-type: none"> • Used to climb coconut palms 	

Appendix IV

Diameter estimated based on circumference

	T1	T2	T3	T4	T5	T6	T7	T8	T9	T10	T11	T12	T13	T14	T15	T16	T17	T18	T19	T20
1 m	178	166	166	166	156	156	169	181	162	162	121	146	137	146	153	146	166	153	137	131
2 m	140	156	159	159	150	150	162	172	156	156	111	140	134	140	146	140	156	150	131	124
3 m	134	150	153	153	146	143	156	162	150	150	105	137	127	134	143	134	146	137	127	121
4 m	127	140	146	150	140	140	153	156	143	143	102	127	131	127	137	134	143	137	127	121
5 m	124	137	143	146	134	134	146	150	137	131	99	124	124	124	137	124	140	134	121	115
6 m	111	131	140	143	131	131	137	140	131	124	95	131	118	121	135	118	134	127	115	111
7 m	99	127	134	140	127	124	131	131	124	121	95	124	121	118	131	118	121	124	111	111
8 m	89	124	131	137	124	118	127	121	121	115	89	121	115	111	121	115	115	118	108	105
9 m	86	115	124	134	118	111	121	115	111	105	80	115	108	105	118	111	111	111	105	105

Appendix V

Maximum measured diameter using vernier caliper

	T1	T2	T3	T4	T5	T6	T7	T8	T9	T10	T11	T12	T13	T14	T15	T16	T17	T18	T19	T20
1 m	172	159	156	152	148	152	158	175	158	154	112	137	131	143	146	143	159	147	129	128
2 m	135	144	152	149	145	146	152	163	151	151	104	133	127	134	140	137	147	140	125	121
3 m	120	141	147	147	143	140	146	158	147	145	102	129	125	131	136	129	141	131	123	118
4 m	113	138	144	146	138	136	141	151	134	137	102	126	120	122	131	123	137	130	121	114
5 m	109	134	140	143	132	129	137	147	128	126	96	124	116	121	131	117	136	127	119	109
6 m	94	128	138	140	129	122	129	135	126	119	89	122	115	116	126	115	126	121	111	107
7 m	91	125	131	137	127	121	126	125	123	117	83	119	115	112	121	114	115	116	109	105
8 m	87	121	128	133	122	115	124	116	119	114	80	112	110	106	116	111	110	111	105	102
9 m	83	112	121	131	115	110	119	110	109	108	76	108	106	102	113	108	108	108	102	102

Appendix VI

Minimum measured diameter using vernier caliper

	T1	T2	T3	T4	T5	T6	T7	T8	T9	T10	T11	T12	T13	T14	T15	T16	T17	T18	T19	T20
1 m	162	157	155	149	145	151	155	174	154	153	111	135	128	142	145	142	158	146	127	125
2 m	134	142	150	148	144	144	151	160	149	150	103	131	126	132	138	135	145	138	124	120
3 m	118	140	146	146	141	138	142	154	146	144	101	127	123	130	132	125	140	130	123	117
4 m	112	136	142	144	137	135	140	149	132	134	101	125	117	120	130	123	134	129	119	114
5 m	107	133	140	142	130	127	134	146	126	125	94	122	115	120	127	115	131	125	117	109
6 m	92	126	137	139	130	120	125	131	123	119	86	119	114	113	125	112	123	119	111	105
7 m	89	124	129	135	125	119	123	123	118	115	82	117	114	111	119	113	112	113	107	103
8 m	85	119	125	131	118	113	121	113	117	111	80	112	111	104	116	110	108	111	103	101
9 m	82	110	120	128	113	128	117	108	109	105	75	107	105	101	112	108	107	106	101	102

Appendix VII

Measurement of height of palm

	Angle (degrees)	Distance from observer to palm (m)	Distance from observer eye to ground (m)
T₁	36.5	10.2	1.45
T₂	38.1	11.3	1.45
T₃	42.3	11.6	1.45
T₄	43.1	12.5	1.45
T₅	40.7	10.3	1.45
T₆	36.5	10.2	1.45
T₇	41.3	10.1	1.45
T₈	37.3	9.8	1.45
T₉	44.8	13.5	1.45
T₁₀	35.7	14.6	1.45
T₁₁	35.2	21.8	1.45
T₁₂	34.3	20.9	1.45
T₁₃	44.8	13.7	1.45
T₁₄	25.1	33.7	1.45
T₁₅	31.5	26.1	1.45
T₁₆	26.9	26.1	1.45
T₁₇	35.7	20.3	1.45
T₁₈	36.8	22.1	1.45
T₁₉	40.7	18.1	1.45
T₂₀	42.8	22.6	1.45

Appendix VIII

Comparison of manual and mechanical climbing

Sl. No.	Manual Climbing	Mechanical climbing
1	It is very hard to learn the necessary skills to climb the tree	Easy to learn
2	The soft skin of palm, chest and foot skin may be disturbed	Less physical damage to climber
3	Climbers can move from one tree to another with the help of rope way in case of walking type climbing	Not possible to move from one tree to another
4	It requires good balance and arm strength	Moderate arm strength is sufficient
5	More accidents can be seen	No accidents
6	Ill effects are more	Less ill effects
7	Skilled person can climb at a speed of 0.5 m/s	Less than 0.5 m/s
8	Less efficient	Efficient device
9	Non reliable	Reliable in nature
10	Less time consuming	More time consuming
11	Costly	Affordable cost

**INVESTIGATIONS ON CLAMPING AND CLIMBING
MECHANISMS FOR THE DESIGN OF SEMI-AUTONOMOUS
ARECA PALM CLIMBER**

by
SUPRITHA
(2015-18-010)

ABSTRACT OF THESIS

Submitted in partial fulfilment of the requirement for the degree of

MASTER OF TECHNOLOGY

IN

AGRICULTURAL ENGINEERING

(Farm Power, Machinery and Energy)

Faculty of Agricultural Engineering & Technology

Kerala Agricultural University



Department of Farm Power Machinery and Energy
KELAPPAJI COLLEGE OF AGRICULTURAL ENGINEERING AND
TECHNOLOGY
TAVANUR, MALAPPURAM- 679573
KERALA, INDIA
2017

ABSTRACT

Palms are un-branched evergreen trees cultivated mainly for its nuts and one has to climb up the tree for harvesting and other operations like spraying. Considering the difficulty and drudgery involved in this operation different types climbers were developed by researchers and innovators. These climbers essentially consist of two functional mechanisms; the clamping mechanism for gripping the unit to the trunk and climbing mechanism for vertical movement of unit. These developed palm climbers can be categorized based on the type of motion of the unit as continuous, discrete or serpentine and based on the power utilized for actuating the functional components as mechanical or robotic. Further categorization can be done based on the mechanism deployed for the actuating functional components.

The biometric properties of areca palm are important for the design optimization and performance of climber. Among the quantifiable biometric properties diameter, variation of diameter along height, height and tilt angle were identified as the critical properties which has direct influence on design and operations. The diameter of areca palm determines the size of gripping unit, shape and dimensions of gripping arms or structures, their spacing and the distance through which the gripping arms are to be moved for locking and unlocking. Tilt angle is critical in optimizing the height of the climbing unit and the maximum relative movement of functional sets of components. The height of palm does not directly influence the design of the climber; it is a major parameter which affects the operation of the robotic climbers. The time required for completing the climbing is directly influenced by the height and when height increases, it will be difficult to see and operate the climber from the ground.

By analyzing all these data and the past works related to mechanical and robotic climbers, their suitability and merits and demerits, a preliminary model of semi-autonomous areca palm climber was fabricated. The principle of linear actuators was adapted for the design of the climber by incorporating power screw rods and DC motors. The designed climber has two components, one was gripping

unit which will provide to and fro motion to the gripping arms hence the arms grabs the tree. Another component was climbing unit which will provide up and down movement hence the climbing happens. At the beginning, the power was supplied to the lower gripping unit; by the movement of both the arms it grabs/holds the tree. Then the power was supplied to the upper gripping unit. By that both the gripping units grabs the tree trunk tightly. After that, the lower arm releases the contact and moves up by the rotation of main motor. Then lower arm holds the tree trunk, upper arm releases and moves up. This process continues until the desirable height was reached. The arms hold the entire body during climbing. During climbing part of robot was always fixed to the tree trunk. The operation of robot was controlled by wired remote controller. The prototype can be simply installed and controlled on the palm by an inexperienced operator. The device has been tested for its performance and found safe, reliable, and efficient and also reduces the problems in climbing of arecanut tree to a good extend.