

**INVESTIGATIONS ON ENERGY CONVERSION OF  
WASTE COCONUT WATER THROUGH AN UP-FLOW  
ANAEROBIC HYBRID BIOREACTOR**

**by**

**DAYANAND KUMBAR**



**DEPARTMENT OF FARM POWER, MACHINERY AND ENERGY  
KELAPPAJI COLLEGE OF AGRICULTURAL ENGINEERING AND  
TECHNOLOGY**

**TAVANUR - 679573, MALAPPURAM**

**KERALA, INDIA**

**2016**

**INVESTIGATIONS ON ENERGY CONVERSION OF  
WASTE COCONUT WATER THROUGH AN UP-FLOW  
ANAEROBIC HYBRID BIOREACTOR**

by

**DAYANAND KUMBAR**

**(2014-18-108)**

**THESIS**

**Submitted in partial fulfilment of the**

**requirement for the degree of**

**MASTER OF TECHNOLOGY**

**IN**

**AGRICULTURAL ENGINEERING**

**(Farm Power, Machinery and Energy)**

**Faculty of Agricultural Engineering & Technology**

**Kerala Agricultural University**



**DEPARTMENT OF FARM POWER, MACHINERY AND ENERGY  
KELAPPAJI COLLEGE OF AGRICULTURAL ENGINEERING AND  
TECHNOLOGY**

**TAVANUR - 679573, MALAPPURAM**

**KERALA, INDIA**

**2016**

## DECLARATION

I hereby declare that this thesis entitled “**Investigations on energy conversion of waste coconut water through an Up-flow Anaerobic Hybrid Bioreactor**” is a *bonafide* record of research work done by me during the course of research and the thesis has not previously formed the basis for the award of any degree, diploma, associateship, fellowship or other similar title of any other University or Society.

**Tavanur:**

**Date : 21/11/16**

**DAYANAND KUMBAR**

**(2014-18-108)**

## CERTIFICATE

Certified that this thesis entitled “**Investigations on energy conversion of waste coconut water through an Up-flow Anaerobic Hybrid Bioreactor**” is a *bonafide* record of research work done independently by **Mr. Dayanand Kumbar** under my guidance and supervision and that it has not previously formed the basis for the award of any degree, fellowship or associateship to him.

Tavanur:

Date :21/11/16

**Dr. Shaji James P.**

(Chairman, Advisory Committee)

Professor Dept. of FPME

KCAET, Tavanur,

Malappuram, Kerala.

## **CERTIFICATE**

We, the undersigned members of the advisory committee of **Mr. Dayanand Kumbar**, a candidate for the degree of Master of Technology in Agricultural Engineering with major in Farm Power, Machinery and Energy, agree that the thesis entitled “**Investigations on energy conversion of waste coconut water through an Up-flow Anaerobic Hybrid Bioreactor**” may be submitted by **Mr. Dayanand Kumbar** in partial fulfillment of the requirement for the degree.

**Dr. Shaji James P., (Chairman)**

Professor, Department of Farm Power, Machinery and Energy,  
Kelappaji College of Agricultural Engineering and Technology, Tavanur.

### **Members:**

**Dr. Jayan P.R.**

**(Member)**

Professor and Head,  
Engineering), Department of FPME,  
Engineering, KCAET, Tavanur.

**Er. J. Renuka Kumari**

**(Member)**

Associate Professor (Civil  
Department of Agricultural  
College of Agriculture, Vellayani

**Er. Shivaji K.P.**

**(Member)**

Assistant Professor (FPME),  
Department of FPME,  
Station,  
KCAET, Tavanur.

**Dr. V. Thulasi**

**(Member)**

Assistant Professor (Soil Science),  
Regional Agricultural Research  
Pattambi.

**EXTERNAL EXAMINER**

**(Name and Address)**

# *ACKNOWLEDGEMENT*

## **ACKNOWLEDGEMENT**

*It is a matter of pleasure to glance back and recall the path one traversed during the days of hard work. It is still great at this juncture to recall all the faces and spirits in the form of teachers, friends, near and dear ones. I would consider this work nothing more than incomplete without attending to task of acknowledging the overwhelming help i received during this endeavor of mine.*

*I would like to give my first thanks to almighty **God** and my **Parents** as without their mercy, accomplishment of my work and preparation of this manuscript would have not been possible.*

*I can't but consider myself lucky to have worked under the guidance of inimitable synergic and helpful but unassuming personality **Dr. Shaji James P.**, Professor, Department of Farm Power, Machinery and Energy, Kelappaji College of Agricultural Engineering and Technology, Tavanur, as Major Advisor of my project. He is a source of inspiration to me throughout the period of my research work. I take this opportunity to express my heart-felt gratitude towards him. I had really a great pleasure and privilege to be associated during this research work.*

*It is my pleasure to pay tribute to **Dr. Hajilal M.S.**, Dean, K.C.A.E.T, Tavanur, for his advice and guidance rendered during this study.*

*I would like to express my heartfelt gratitude to **Dr. Sivaswami M.**, former Dean, K.C.A.E.T, Tavanur, for his interest and kind advice given to me at all stages of my study.*

*I am gratified to record sincere thanks to the members of the advisory cornmittee **Dr. Jayan P.R.**, Professor and Head, Department of Farm Power, Machinery and Energy, Kelappaji College of Agricultural Engineering and Technology, Tavanur, **Er. J. Renuka Kumari**, Associate Professor, (Civil Engineering), Department of Agricultural Engineering, College of Agriculture, Vellayani, **Er. Shivaji K.P.** Assistant Professor, Department of Farm Power, Machinery and Energy, Kelappaji College of Agricultural Engineering and Technology, Tavanur and **Dr. V. Thulasi**, Assistant Professor (Soil Science), Regional Agricultural Research Station, Pattambi for their valuable counsel,*

*note-worthy guidance and cordial co-operation during my research programme.*

*I place my special thanks to, **Dr. Rema K.P.**, Professor, Dept. of Irrigation and Drainage Engineering, K.C.A.E.T, Tavanur, **Dr. Sathian K.K.**, Professor, Dept. of Land and Water Resources Engineering, K.C.A.E.T, Tavanur, **Er. Suma Nair**, Assistant Professor, Department of Farm Power, Machinery and Energy, Kelappaji College of Agricultural Engineering and Technology, Tavanur and **Dr. Sunil Culas**, Teaching Assistant (Chemistry) Dept. of SBC, K.C.A.E.T, Tavanur, for their valuable guidance, profound suggestions and constant encouragement and advice throughout the project work.*

*My heartfelt gratitude to **Sri. Sudheer V.**, **Mr. Manu M.M.**, and **Mr. Shajithlal P.P.**, cannot be captured in words for their co-operation and assistance during the fabrication work.*

*I also wish to thank our senior friends **Vikas L.**, **Ajay G.**, **Younus A.**, and **Sreerag P.M.**, and all others for their kind support and guidance.*

*My completion of this project could not have been accomplished without the support of my classmates especially, **Madhukumar**, **Keshava**, **Hareesh**, **Dipak**, **Seema**, **Sankalpa**, **Srikant**, **Ayisha**, **Lakshminarayana**, **Salsan**, **Naveen**, **Uttam** and **Arjun** for their suggestion and invaluable help during my study.*

*I gratefully acknowledge the service rendered by **Sri.Gobinath** owner Edible Oil Mill, Pattambi and **Sri. Muneer** owner Nila oil Mill, Kuttippuram.*

*I also extend my sincere thanks to **Sri. Prakash**, worker at Edible Oil Mill, Pattambi for the help offered during the research work.*

*I express my thanks to all the faculty **members of Library**, KCAET, Tavanur for their ever willing help and cooperation. I express my sincere thanks and gratitude to **Kelappaji College of Agricultural Engineering & Technology** for giving me an opportunity to undergo my P.G studies and **Kerala Agricultural***



*University for providing me the KAU merit scholarship and for having proffered me a chance to study in this institution.*

*I am greatly indebted to my parents **Smt. Mallamma** and **Sri. Shankreppa** for their blessings, prayers, and support, without which I could not have completed this work.*

*I am greatly indebted to my brothers **Mr. Shivanand** and **Mr. Chidanand** for their valuable advice, encouragement and support during the course of study.*

*One last word; since it is practically impossible to list all the names who have contributed to my work, it seems proper to issue a blanket of thanks for those who helped me directly or indirectly during the course of study.*

**Dayanand Kumbar**

*Dedicated to  
Mother*

## CONTENTS

---

Chapter No.	Title	Page No.
	LIST OF TABLES	i
	LIST OF FIGURES	iii
	LIST OF PLATES	iv
	SYMBOLS AND ABBREVIATIONS	v
I	INTRODUCTION	1
II	REVIEW OF LITERATURE	4
III	MATERIALS AND METHODS	17
IV	RESULTS AND DISCUSSION	35
V	SUMMARY AND CONCLUSION	66
	REFERENCES	70
	APPENDICES	76
	ABSTRACT	86

---

## LIST OF TABLES

<b>Table No.</b>	<b>Title</b>	<b>Page No.</b>
4.1	Characteristics of WCW	35
4.2	Performance parameters of floating gas holder digester at 35-day HRT	37
4.3	Performance parameters of floating gas holder digester at 30-day HRT	39
4.4	Performance parameters of floating gas holder digester at 25 - day HRT	42
4.5	Operational parameters of WCW at different HRTs	44
4.6	Influent and effluent characteristics during initial operation	45
4.7	Performance parameters of UAHBR during initial operation	45
4.8	Influent and effluent characteristics during 15-day HRT	47
4.9	Performance parameters of full scale UAHBR at 15-day HRT	48
4.10	Physical characteristics of packing media	50
4.11	Influent characteristics during 15-day HRT period	51
4.12	Influent and effluent characteristics during 15-day HRT	52
4.13	Performance parameters of experimental UAHBR at 15-day HRT	53
4.14	Influent and effluent characteristics during 12-day HRT	54
4.15	Performance parameters of experimental UAHBR at 12-day HRT	55
4.16	Influent and effluent characteristics during 10-day HRT	56
4.17	Performance parameters of experimental UAHBR at 10-day	

	HRT	57
4.18	Influent and effluent characteristics during 8-day HRT	58
4.19	Performance parameters of experimental UAHBR at 8-day HRT	59
4.20	Influent and effluent characteristics during 6-day HRT	60
4.21	Performance parameters of experimental UAHBR at 6-day HRT	60
4.22	Gas production performance of the UAHBR at different HRTs	61
4.23	TS and BOD reduction during different HRTs	62
4.24	Loading rates at different HRTs	63

---

## LIST OF FIGURES

<b>Fig. No.</b>	<b>Title</b>	<b>Page No.</b>
3.1	Schematic diagram of floating gas holder digester	25
3.2	Schematic diagram of full scale UAHBR	27
3.3	Schematic diagram of experimental UAHBR	33
4.1	Variation of pH and daily biogas production during 35-day HRT	38
4.2	Variation of TS and biogas productivity during 35-day HRT	38
4.3	Variation of pH and daily biogas production during 30-day HRT	40
4.4	Variation of TS and biogas productivity during 30-day HRT	41
4.5	Variation of pH and daily biogas production during 25-day	42
4.6	Variation of TS and biogas productivity during 25-day HRT	43
4.7	Variation of pH and daily biogas production during initial operation	46
4.8	Specific biogas production and TS reduction during initial operation	47
4.9	Variation of pH and daily biogas production during 15-day HRT	49
4.10	Specific biogas production and TS reduction during 15-day HRT	50
4.11	Variation of pH and daily biogas production during 15-day HRT	54
4.12	Variation of pH and daily biogas production during 12-day HRT	56
4.13	Variation of pH and daily biogas production during 10-day HRT	58
4.14	Variation of pH and daily biogas production during 8-day HRT	59
4.15	Variation of pH and daily biogas production during 6-day HRT	61
4.16	TS, BOD and specific biogas production at different HRTs	63
4.17	Variation of loading rates during different HRTs	64

## LIST OF PLATES

<b>Plate No.</b>	<b>Title</b>	<b>Page No.</b>
3.1	BOD incubator	18
3.2	pH meter	19
3.3	Wet type gas flow meter	21
3.4	Sacharometer	22
3.5	Floating gas holder digester with wet gas flow meter installed at oil mill	24
3.6	Full scale UAHBR installed at Edible Oil Mill, Pattambi	28
3.7	Broken Coconut shells used as media for bio-film growth	29
3.8	Experimental UAHBR installed at Nila Oil Mill, Kuttippuram	32

## SYMBOLS AND ABBREVIATIONS

Abbreviations	Description
°C	: Degree Celsius
±	: Plus or minus
Ø	: Diameter
AF	: Anaerobic Filter
AFB	: Anaerobic Fluidized Bed
APHA	: American Public Health Association
BOD	: Biochemical Oxygen Demand
BW	: Brewery Waste
CaCl <sub>2</sub>	: Calcium Chloride
CD	: Cattle Dung
CDB	: Coconut Development Board
CH <sub>4</sub>	: Methane
COD	: Chemical Oxygen Demand
CO <sub>2</sub>	: Carbon Dioxide
D	: Day
DO	: Dissolved Oxygen
ETPs	: Effluent Treatment Plants
FeCl <sub>3</sub>	: Ferric Chloride
Fig.	: Figure
FRP	: Fibre Reinforced Plastic
g	: Gram
h	: hour
ha	: hectare
HRT	: Hydraulic Retention Time



Insref	:	Instrumentation and Refrigeration
ID	:	Internal diameter
kg	:	Kilogram
KOH	:	Potassium Hydroxide
L	:	Litre
m	:	Meter
m <sup>2</sup>	:	Meter square
mg	:	Milligram
MgSO <sub>4</sub>	:	Magnesium Sulfate
mL	:	Millilitre
mm	:	Millimetre
MT	:	Metric tonne
NRV	:	Non Return Valve
PVC	:	Poly Vinyl Chloride
TS	:	Total Solids
UAF	:	Up-flow Anaerobic Filter
UAHR	:	Up-flow Anaerobic Hybrid Reactor
UAHBR	:	Up-flow Anaerobic Hybrid Bioreactor
VS	:	Volatile Solids
WCW	:	Waste Coconut Water

---

# *INTRODUCTION*

## **CHAPTER I**

### **INTRODUCTION**

The coconut (*cocos nucifera*) is an important crop in the tropical regions. India is the third largest coconut producing country in the world after Indonesia and Philippines. The annual production of coconut in India was 1,49,40,000 MT in 2011-12 and Kerala ranked second in India with a production of 39,74,000 MT (CDB, 2014). Kerala has the maximum area under coconut cultivation in India with an area of 8,08,647 ha (Department of Economics and Statistics, 2015) and coconut palm is the main source of income to millions of families in the state. It is one of the most versatile crops for edible oil production and coconut oil production is one among the most important agro-industries in the state of Kerala.

A large number of coconut oil mills are operating in tropical countries like India. They discharge considerable amount of waste coconut water (WCW) having very high values of Biochemical Oxygen Demand (BOD) to the extent of 29,000 mg·L<sup>-1</sup> (Sison, 1977) and Total Solids (TS) of 5.45 ± 0.35% (Tripetchkul *et al.* 2010). Tripetchkul *et al.* (2010) has also reported that the fermented coconut water is highly acidic with a pH of 4.03 ± 0.01. The south Indian states, especially Kerala has a large number of coconut oil mills and most of them discharge the WCW without proper treatment resulting in pollution of the environment. Due to the bad odour and pollution of water bodies, the general public have started complaining against the coconut oil mills. Hence many Local Self Government bodies and the State Pollution Control Boards have imposed stringent restrictions on these small scale agro based industrial units. Installation of conventional ETPs (Effluent Treatment Plants) is costly and they consume electric power for their operation. It is highly relevant to save these small scale agro industries by providing an affordable technology for pollution abatement, which is also capable of producing energy.

Anaerobic digestion of organic wastes is a known technology. Anaerobic digestion is the degradation of complex organic matters in an oxygen free environment. The biological conversion of the organic matters occurs in the

mixture of primary settled and biological sludge under anaerobic condition followed by hydrolysis, acidogenesis and methanogenesis to convert the complex compounds into simpler end products as methane (CH<sub>4</sub>) and carbon dioxide (CO<sub>2</sub>) (Gerardi, 2003). This technology offers simultaneous production of energy in the form of biogas along with pollution control.

The technical problems associated with conventional biogas plants in dealing with high volume low strength wastes like waste waters make them less popular for effluent treatment. They are slow in operation with long Hydraulic Retention Times (HRTs) in the order of 35 to 55 days, necessitating very large digester volumes. The requirement of large digesters consume much space and makes their installation very costly (James and Kamaraj, 2002). Hence people are tempted to adopt aerobic treatment systems in which energy is being consumed for aeration. Even though the anaerobic waste treatment is more environment friendly the aforesaid technical constraints are the bottlenecks in adoption of technology.

Anaerobic digestion of high volume liquid wastes like WCW is technically and economically feasible only through high rate bioreactors, where we can reduce the HRTs to few days or even hours. The anaerobic bioreactors which can retain high level of biomass (microbial) population in the reactor, and remove higher percentages of organic matter is known as the "high-rate anaerobic bioreactor". High rate anaerobic bioreactors include the Up-flow Anaerobic Hybrid reactor (UAHR), the Anaerobic Filter (AF), the Up-flow Anaerobic Sludge Blanket (UASB) reactor, the Anaerobic Fluidized Bed (AFB) reactor and anaerobic membrane bioreactors. In many high rate reactors (except UASB) inert media for cell immobilization play an important role in enhancing the treatment efficiency, and the most significant functions of inert media are retention of active sludge in the reactor. High rate anaerobic digesters are very good for treating low strength effluents with maximum gas production and less space required compared to conventional methods.

Proper care in the design and operation of high rate bioreactors are essential for getting optimum results from the technology. This requires investigations for obtaining the optimum operating parameters like Hydraulic Retention Time, loading rate etc. Different organic effluents have different characteristics and they may behave differently when subjected to biomethanation. This is especially important in the case of WCW because it is highly acidic and can be problematic. A pilot scale UAHBR has been installed at Edible Oil Mill, Pattambi by Krishi Vigyan Kendra- Palakkad. It is required to have a detailed investigation on the performance of the bioreactor so as to formulate guidelines for design, installation and successful operation of full scale bioreactors.

### **Objectives**

The major objective of the present study was to acquire required information on the biomethanation of Waste Coconut Water (WCW) through high rate biomethanation. The specific objectives were as follows:

1. To study the biomethanation characteristics of waste coconut water.
2. To study the energy production potential of waste coconut water through anaerobic digestion in a high rate bioreactor.
3. To study the process parameters of an Up-flow Anaerobic Hybrid Bioreactor (UAHBR) for energy conversion of waste coconut water with a view to evolve guidelines for design, installation and operation.

# *REVIEW OF LITERATURE*

## CHAPTER II

### REVIEW OF LITERATURE

This chapter deals with a comprehensive review of the studies conducted by various research workers relevant to anaerobic digestion of waste coconut water (WCW). These include investigations on the characteristics of WCW and on biomethanation of organic effluents in high rate anaerobic bioreactors.

#### 2.1 Characteristics of waste water from coconut processing units

Smith and Bull (1976) reported that waste coconut water represents a serious pollution risk since it is usually disposed to run off from coconut processing compounds into waterways and agricultural land. The waste coconut water had a BOD value about  $40000 \text{ mg}\cdot\text{L}^{-1}$ . Sison (1977) reported on the environmental problems due to desiccated coconut factories. The matured coconut water was considered as a waste having a BOD value of  $29,000 \text{ mg}\cdot\text{L}^{-1}$  and the wash water about  $3,000 \text{ mg}\cdot\text{L}^{-1}$ .

Tripetchkul *et al.* (2010) studied the utilization of wastewater originated from naturally fermented virgin coconut oil manufacturing process. They found that the wastewater had a pH  $4.03 \pm 0.01$ , TS (%)  $5.45 \pm 0.35$ , oil and grease (%)  $4.04 \pm 0.01$ , and a COD of  $3540 \pm 0.10 \text{ mg}\cdot\text{L}^{-1}$ .

Rajagopal *et al.* (2013) reported that food and agro-product industries contribute about 65-70% of the organic pollutants which is released to the water bodies in India.

#### 2.2 Biomethanation of food processing and agro-industrial effluents

A two phase anaerobic digestion of three different dairy effluents were investigated by Strydom *et al.* (1997). They reported that a COD reduction of 91 and 97% could be obtained at an OLR between 0.97 and  $2.82 \text{ kg COD m}^3\cdot\text{d}^{-1}$ . They got methane yields ranging from 0.287 to  $0.359 \text{ m}^3\cdot\text{CH}_4\cdot\text{kg}^{-1}\cdot\text{COD}_{\text{removed}}$ .

Rao *et al.* (2005) conducted a study on anaerobic treatability of wastewater with high suspended solids derived from bulk drug industry using a fixed film reactor. They obtained a BOD removal of 80-90% at an optimum OLR of 10 kg·COD·m<sup>-3</sup>·d<sup>-1</sup>.

A laboratory scale study was conducted by Acharya *et al.* (2008) on anaerobic treatment of distillery-spent wash in an up-flow anaerobic fixed film bioreactor. Among various support materials the reactor having coconut coir could treat the distillery spent wash at 8 day HRT with OLR of 23.25 kg·COD·m<sup>-3</sup>·d<sup>-1</sup>. They could get a biogas production of 7.2 m<sup>3</sup>·m<sup>-3</sup>·d<sup>-1</sup>.

Chen *et al.* (2010) studied the anaerobic digestion of food wastes derived from a soup processing plant, cafeteria, commercial kitchen, fish farm, and grease trap collection service. They operated digesters at mesophilic (35°C) and thermophilic (50°C) temperatures and at food to microorganism ratios (F/M) of 0.5 and 1.0, for 28 days. The average methane contents of the biogas obtained at F/M 0.5 and 1.0 were 62% and 59% from mesophilic reactors and 64% and 60% for thermophilic reactors, respectively.

Gonzalez-Gonzalez *et al.* (2013) experimented the anaerobic codigestion for biomethanation of pig slaughter house and tomato industries wastes. They observed a COD reduction from 54 to 80% at HRTs ranging from 8 to 33 days. The treated wastewater could be used as irrigation water.

Tewelde *et al.* (2013) conducted the experiments on biogas production from the anaerobic single stage co-digestion of brewery wastes (BW) and cattle dung (CD) in batch mode at mesophilic conditions. They obtained a conversion of 73.8% of the organic solids fed into digester at 40 days HRT. The average gas yield was 0.290 m<sup>3</sup>·kg<sup>-1</sup>·VS<sub>added</sub>. Maximal overall methane productivity was attained when the ratio CD/BW was 70:30. Maximum organic loading rate was 3.3 kg·VS·m<sup>-3</sup>·d could be achieved in the semi-continuous digestion at 70:30 ratio without clogging of the digester.



Efficacies of various inoculum sources on methane production from agro-industrial wastewaters were studied by Auphimai *et al.* (2014). They used inoculum and wastewaters from various agro-industrial wastewaters such as rubber factory, cassava starch factory, palm oil mill factory, swine farm and soymilk processing factory, and found that all the inoculum can be used to degrade the exogenous wastewaters to methane. They observed that effect of inoculum to start-up the anaerobic reactor depends on the initial activity and wastewater composition.

Dareiot and Kornaros (2014) studied the effect of HRT on the anaerobic co-digestion of agro-industrial wastes in a two stage continuous stirred tank reactors. They operated the reactors at HRTs of 20 and 25 day. During 20 day HRTs the reactor became unstable due to accumulation of volatile fatty acids. The methane production rate was  $0.33 \text{ L}\cdot\text{CH}_4\cdot\text{L}^{-1}\cdot\text{d}_{\text{removed}}$  at 25 day HRT.

Koupaie *et al.* (2014) experimented on mesophilic batch anaerobic co-digestion of fruit-juice industrial waste and municipal waste sludge. They observed maximum cumulative methane yield of  $890.90 \text{ mL}\cdot\text{g}^{-1}\cdot\text{VS}_{\text{removed}}$ .

Ghasimi *et al.* (2016) studied the biomethanation of fine sieved fraction from municipal raw sewage. They found that thermophilic conditions are advantageous over mesophilic conditions.

### **2.3 High rate bioreactors for energy conversion of organic waste waters**

The anaerobic reactor which can retain high level of biomass population in the reactor, and remove higher percentages of organic matter is known as the "high-rate anaerobic reactor". James and Kamaraj (2002) described the techniques of immobilized cell anaerobic bioreactors for energy production from agro-processing waste waters. They reported that the concept of retention and maintenance of biological growth on inert support materials is the basis for many such bioreactor designs. They opined that Anaerobic Filter, Up Flow Anaerobic Sludge Blanket (UASB) Reactor and Anaerobic Fluidized Bed Reactor and Up-flow Anaerobic Hybrid Reactors (UAHR) offer much scope in energy conversion of organic effluents.

Alvarez *et al.* (2008) conducted the study on two-stage anaerobic treatment for low-strength municipal wastewater. They reported that BOD removal ranging from 76 to 89% for the first stage digester and 50 to 77% for second stage digester.

Mohan and Sunny (2010) studied the biomethanation of wastewater obtained from jam industries in a continuous reactor. They found that optimum OLR of  $6.5 \text{ kg} \cdot \text{COD} \cdot \text{m}^{-3} \cdot \text{d}^{-1}$  at 3 days HRT. The specific methane production was  $0.28 \text{ m}^3 \cdot \text{kg}^{-1}$  of  $\text{COD}_{\text{removed}} \text{ d}^{-1}$ .

Choi *et al.* (2013) investigated the anaerobic treatment of palm oil mill effluent using combined high-rate anaerobic reactors. The hybrid reactor was incorporated by two different secondary filter reactors. The hybrid reactor had pall rings in the upper part of the reactor up to a depth of 15 cm as a packing media. This packing media served as a gas-solid liquid separator as well as filter. They obtained an overall COD removal efficiency of 93.5% in both hybrid reactor and filter. Results showed enhanced COD removal efficiency and performance stability in the hybrid reactor compared to filters. They obtained biogas up to  $110 \text{ L} \cdot \text{d}^{-1}$  with a yield of  $0.171\text{-}0.269 \text{ L} \cdot \text{CH}_4 \cdot \text{g}^{-1}$ . The methane content in biogas was 59.5- 78.2%.

Alonso *et al.* (2014) studied the performance of up-flow anaerobic fixed bed reactor for the treatment of sugar beet pulp lixiviation in thermophilic range of temperature ( $55^\circ\text{C}$ ). They operated the reactor at different HRTs of 11 to 1.5 days. and reported a COD removal efficiency of 90% for 6 days-HRT. The COD removal efficiency was reduced to the range of 74.3% to 59.4% on further reducing the HRT.

### **2.3.1 Up Flow Anaerobic Filter**

Young and McCarty (1969) initially developed an anaerobic filter system which incorporated a column packed with an inert support material such as gravel, ceramic, fired clay etc. The system with its feed inlet at the bottom creates an upward flow through the submerged matrix is referred as up flow anaerobic filter

(UAF). The biomass is attached to the media surfaces as a thin film as well as entrapped within the media matrix.

Borja and Banks (1994) reported that anaerobic filter is capable of treating wastewaters to give good effluent quality with at least 70% of COD removal efficiency with methane compositions more than 50%. When Palm Oil Mill Effluent (POME) waste-water was fed at an OLR ranging from 1.2 to 11.4 kg·COD·d<sup>-1</sup>, overall COD removal efficiency was up to 90% with an average methane gas content of 60%. The COD removal efficiency recorded was 94% with 63% of methane at an OLR of 4.5 kg COD m<sup>-3</sup>·d.

Nebot *et al.* (1995) studied the effect of feed frequency on the performance of lab scale anaerobic filters. They reported that the acid character of feed material must be neutralised before feeding and could be achieved by adding a concentrated NaOH solution. They observed a continuous increased COD removal efficiency of around 95% with an increase in the feed frequency in continuous feeding reactor.

Hanqing and Guowei (1996) studied the biomethanation of brewery wastewater in an anaerobic up-flow blanket filter (UBF). They operated the UBF at HRT ranging from 48 to 40 h and reported a COD removal about 90%. The biogas contained 79% methane.

Leal *et al.* (1998) studied the mesophilic range digestion of brewery wastewater in an unheated anaerobic filter. They operated the filter for 6 months at 10 hour HRT throughout the study. They observed a mean COD removal of 96%, and a biogas production of 7.1 m<sup>3</sup>·d<sup>-1</sup> at an OLR of 8 kg·COD·m<sup>-3</sup>·d.

Reyes *et al.* (1999) conducted a laboratory-scale study on anaerobic treatability of low-strength wastewater (Piggery waste sieved to 1 mm and diluted to approximate COD concentration of 1000 mg·L<sup>-1</sup> was used as influent) in a multistage anaerobic filter packed with waste tyre rubber. They operated a reactor in different HRTs of 4, 2 and 1 days, and 12 and 8 h. BOD removal efficiencies more than 60% during 4, 2 and 1 days HRTs.

Wang and Banks (2007) treated the high-strength sulphate-rich alkaline leachate in anaerobic filter. They operated the filter over 152 days. They could get COD removal of 75-90% at 3 day HRT. The average methane generation rate was  $0.10 \text{ L}\cdot\text{g}^{-1}\cdot\text{COD}_{\text{removed}}$ .

The development of an improved anaerobic filter for municipal wastewater treatment was done by Bodkhe (2008). He used burnt brickbats as packing media, having an average diameter of 20 mm and specific surface area of  $200 \text{ m}^2\cdot\text{m}^{-3}$ . He operated the reactor at different HRTs for 600 days and observed BOD and COD reductions of 90% and of 95% respectively, at HRTs higher than 12 hour. HRTs lower than 12 h resulted in deteriorated quality of effluent. The biogas content was 60-70% methane, 30-35% carbon dioxide and traces of hydrogen sulphide.

Yilmaz *et al.* (2008) studied the performance of two anaerobic filters for treating paper mill wastewater in mesophilic and thermophilic temperature conditions. They operated two anaerobic filters, one mesophilic (35°C) and one thermophilic (55°C) in different HRTs ranging from 6 to 24 h at an OLR of  $1.07\text{-}12.25 \text{ g}\cdot\text{L}^{-1}\cdot\text{d}^{-1}$ . They found no difference in terms of the removal of soluble COD and gas production at loading rates up to  $8.4 \text{ g}\cdot\text{COD}\cdot\text{L}^{-1}\cdot\text{d}$ . At the higher organic loading rate, the Soluble COD removal performance of thermophilic digester was slightly higher compared to mesophilic digester. The results revealed that stability of thermophilic digester was better than mesophilic digester particularly for the higher organic loadings.

Kurniawan *et al.* (2015) studied the treatment of cajuput oil industry wastewater using anaerobic filtration. They observed that reduction levels in BOD, COD and TSS of the waste water were  $39.34 \pm 1.61 \text{ mg}\cdot\text{L}^{-1}$ ;  $67.73 \pm 0.00 \text{ mg}\cdot\text{L}^{-1}$ ; and  $7.20 \pm 0.23 \text{ mg}\cdot\text{L}^{-1}$ , respectively.

### **2.3.2 Up-flow Anaerobic Sludge Blanket Reactor**

The Up-flow Anaerobic Sludge Blanket Reactor (UASB) concept was initially evolved by Lettinga *et al.* (1980) and have been widely used for anaerobic treatment of organic effluents. Borja and Banks (1994<sup>a</sup>) reported Palm Oil Mill Effluent (POME) treatment has been successful with UASB reactor, achieving

COD removal efficiencies up to 98.4% with the highest operating OLR of 10.63 kg·COD·m<sup>-3</sup>·d<sup>-1</sup>. However, reactor operated under overload conditions with high volatile fatty acid content became unstable after 15 days.

Najafpour *et al.* (2006) reported that the use of Up-flow Anaerobic Sludge-Fixed Film (UASFF) reactor was a good strategy to accelerate anaerobic granulation and to achieve high COD removal efficiency in a short period of time. High COD removals of 89 and 97% were observed at of 1.5 and 3 days HRT, respectively. Methane yield of 0.346 L·CH<sub>4</sub>·g<sup>-1</sup>·COD<sub>removed</sub> at the highest organic loading rate of 23.15 g·COD·L<sup>-1</sup>·d was also obtained.

Poh (2014) successfully investigated the treatment of Palm Oil Mill Effluent (POME) under thermophilic condition. The Up-flow Anaerobic Sludge Blanket-Hollow Centered Packed Bed (UASB-HCPB) reactor had a successful start-up after 36 days of operation. They observed COD and BOD removals of 88% and 90% respectively with 52% of methane in the biogas at an OLR of 28.12 g·L<sup>-1</sup>·d. Best performance of the reactor was achieved under OLR of 6.66 g·L<sup>-1</sup>·d<sup>-1</sup>, HRT of 5 days.

### **2.3.3 Anaerobic Fluidized Bed Reactor**

Garcia-Calderon *et al.* (1998) studied the anaerobic digestion of wine distillery wastewater in down-flow fluidized bed reactor. They used fluidized particles of ground perlite and expanded volcanic rock, which had smaller specific density than the liquid. After reactor reaching the steady-state, organic loading rate was increased stepwise by reducing HRT, from 3.3±1.3 days. The reactor achieved 85% Total Organic Carbon (TOC) removal, at an organic loading rate of 4.5 kg·TOC·m<sup>3</sup>·d<sup>-1</sup>. The main advantage of this system was low energy requirement because it required low velocity for fluidization. There was no need of a settling device because solids accumulate at the bottom of the reactor so that it could be easily drawn out.

Sen and Demirer (2003) studied the anaerobic treatability of textile factory wastewater using fluidized bed reactor. They found that COD, BOD and colour removals were around 82%, 94% and 59% respectively, for an HRT of 24 h and OLR of  $3 \text{ kg}\cdot\text{COD}\cdot\text{m}^{-3}\cdot\text{d}^{-1}$ .

Wang *et al.* (2016) studied the two lab-scale anaerobic fluidized bed bioreactors treating primary sludge (PS) and thickened waste activated sludge (TWAS). They obtained a COD and VSS removal of 62% and 63%, respectively, at an OLR of  $18 \text{ kg}\cdot\text{COD}\cdot\text{m}^{-3}\cdot\text{d}^{-1}$  and an HRTs of 2.2 days for PS. Whereas, COD and VSS removal of 56% and 50%, respectively were obtained at an OLR of  $12 \text{ kg}\cdot\text{COD}\cdot\text{m}^{-3}\cdot\text{d}^{-1}$  at 4 days HRT.

#### **2.2.4 Anaerobic Membrane Bioreactors**

In Anaerobic Membrane Bioreactors (AnMBR) all biomass will retain in the reactor effectively without sludge washout from the reactor irrespective of short HRT (Lin *et al.*, 2013). It produces superior effluent quality in terms of suspended solids, COD and pathogen count. Effluent could be reused and recycled for non-potable purposes.

Bae *et al.* (2014) compared the performance of single and staged anaerobic fluidized bed membrane bioreactors for anaerobic treatment of low-strength wastewater. They operated the both reactors over more than 200 days at HRTs of 2-4 hours to achieve COD removals of 93-96 %. There was no significant difference in performance of both reactors.

Jensen *et al.* (2015) studied the high rate treatment of slaughterhouse wastewater in anaerobic membrane bioreactors. They reported that COD removal efficiency and methane yields were not impacted by HRT or OLR. The COD removal from the wastewater was over 95%.

#### **2.3.5 Anaerobic Hybrid Bioreactors**

Lo *et al.* (1994) investigated the anaerobic digestion of swine wastewater using a hybrid up-flow anaerobic sludge blanket reactor. They hybridized the UASB by a rope matrix which was fixed in the midsection of the reactor in order

to achieve the advantages of both suspended-growth and attached-growth of microorganisms in the reactor system. They operated the reactor for 18 weeks at different HRTs of 3.28, 6.75 and 7.2 days. They could get over 57% COD removal and  $0.71 \text{ L}\cdot\text{CH}_4\cdot\text{L}^{-1}$  reactor day at moderate organic loading rates. They opined that hybrid UASB could be used without seeding in the treatment of screened swine manure if the organic loading rates were moderate.

Cordoba *et al.* (1995) developed a laboratory scale hybrid reactor for treating dairy industry wastewater. The reactor had a height of 225 mm and internal diameter of 134 mm. They used polyurethane foam as packing material. They found organic matter removal efficiency of 92% and a gas production of  $4.64 \text{ L}^{-1}\cdot\text{L}^{-1}\cdot\text{d}$ , at the highest organic loading rate of  $8 \text{ g}\cdot\text{COD}\cdot\text{L}^{-1}\cdot\text{d}^{-1}$ .

Borja *et al.* (1996) studied the anaerobic digestion of wash waters derived from the purification of virgin olive oil in a hybrid reactor. They hybridized the reactor by combining a filter and a sludge blanket. The reactor had a liquid height of 40 cm with the top two-third portions filled with clay rings having a porosity of 63%, specific surface area of  $250 \text{ m}^2\cdot\text{g}^{-1}$  and a bulk density of  $0.9 \text{ m}^2\cdot\text{g}^{-1}$ . They operated the reactor at HRTs of 0.20 to 1.02 days under normal operating conditions after the start-up. They observed a COD removal efficiency of more than 89% at an OLR of  $8 \text{ kg}\cdot\text{COD}\cdot\text{m}^{-3}\cdot\text{d}$ .

Bello-Mendoza and Castillo-Rivera (1998) described the start-up of an anaerobic hybrid reactor treating wastewater from a coffee processing plant. They reported that unadapted seed sludge showed a low specific methanogenic activity of  $26.47 \text{ g}\cdot\text{CH}_4$  during start-up. After a few days of operation, the reactor could achieve a COD removal of 77.2% at an OLR of  $1.89 \text{ kg}\cdot\text{COD}\cdot\text{m}^{-3}\cdot\text{d}$  at an HRT of 22 h, while, suddenly increasing OLR above  $2.4 \text{ kg}\cdot\text{COD}\cdot\text{m}^{-3}\cdot\text{d}$  showed a deterioration in treatment efficiency. The reactor was recovered from shock loads after a shutdown of 1 week. The reactor could prevent the biomass from washing-out and was capable of quick start-up.

Kleerebezem *et al.* (1999) studied the high-rate treatment of terephthalate in three anaerobic up-flow reactors. They operated these reactors at temperatures 30, 37, and 55°C. The terephthalate removal capacities remained low in all three reactors due to limitations in biomass retention. To enhance biomass retention, the reactors were modified to anaerobic hybrid reactors by introduction of two types of reticulated polyurethane foam particles. The terephthalate conversion capacity of the hybrid reactors increased exponentially at a specific rate of approximately 0.06 per day, and high COD removal rates of 10-17 g of COD·L<sup>-1</sup>·d<sup>-1</sup> at HRTs between 5 and 8 hour were obtained.

James and Kamaraj (2003) developed an Up-flow Anaerobic Hybrid Bioreactor (UAHBR) incorporating the concepts of Anaerobic Filter and UASB, in which coconut shells were used as the media for cell immobilization. They studied the performance of the UAHBR in treating cassava factory effluent by operating the bioreactor on HRTs from 15 to 1 day (James and Kamaraj, 2003<sup>a</sup>). They observed a maximum specific gas production of 908.5 L·kg<sup>-1</sup>·TS and a COD reduction of 98%. Coconut shell has been found to perform as good as PVC as media for the reactor.

McHugh *et al.* (2006) treated the whey wastewaters using two lab scale anaerobic hybrid reactors, R<sub>1</sub> and R<sub>2</sub> at psychrophilic temperatures. They operated both reactors, at low-strength (1 kg·COD·m<sup>-3</sup>) and high-strength (10 kg·COD·m<sup>-3</sup>) whey-based wastewaters, for 500-days. They obtained COD removal efficiencies 70-80%, for reactor R<sub>2</sub> at organic loading rates of 0.5–1.3 kg·COD·m<sup>-3</sup>·d<sup>-1</sup>, between 20 and 12°C. The reactor R<sub>2</sub> showed the decrease in COD removal efficiency, to between 50-60% when the operating temperature was lowered to 12°C. Results revealed that mesophilic (37°C) temperature was optimum for both reactors in maintaining specific methanogenic activity of biomass.

Araujo *et al.* (2008) treated the wastewater derived from the house hold and personal products industry in a hybrid bioreactor. They could obtain COD removal efficiencies of 77, 72 and 80% at HRTs of 50, 40 and 60 h respectively.



Kumar *et al.* (2008) studied on treatment of low strength industrial cluster wastewater by anaerobic hybrid reactor. They operated the reactor at different HRTs ranging from 12 to 4 h, corresponding OLR ranging from 0.56 to 3.12  $\text{kgCODm}^{-3}\cdot\text{d}^{-1}$ . The COD removal of 94% was achieved at an OLR of 2.08  $\text{kg}\cdot\text{COD}\cdot\text{m}^{-3}\cdot\text{d}^{-1}$  at an HRT of 6 h. This reactor combined the best features of both the up-flow anaerobic sludge blanket reactor and anaerobic fluidized bed reactor.

James and Kamaraj (2004) conducted a comparative study by using both raw and treated coconut shells in anaerobic bioreactors as a media and found that the treated media showed better performance than the untreated media.

James and Kamaraj (2009) studied the Up-flow Anaerobic Hybrid Reactor (UAHR) for treating cassava mill effluent. Two different reactors were used such as reactor 1 having coconut shells and reactor 2 having PVC pall rings as media for cell immobilization in the upper half. They operated reactors in different HRTs of 15 days to 1 day and found a very high reduction of 99 and 98.9% BOD and 96.2 and 96% COD for reactors 1 and 2, respectively at the longest HRT of 15 days. The lowest reduction found was 78.9 and 77.4% of BOD and 77.4 and 76% of COD for reactor 1 and 2 respectively at 1 day HRT. A maximum specific gas production of 1108 and 1030  $\text{L}\cdot\text{kg}^{-1}\cdot\text{VS}$  were obtained for reactors 1 and 2, respectively at the longest HRT of 15 days and corresponding minimum values were 725 and 703  $\text{L}\cdot\text{kg}^{-1}\cdot\text{VS}$  at the shortest HRT of 1 day. They confirmed that reactor 1 was superior to reactor 2 in BOD and COD reduction at all HRTs.

Bovas (2009) investigated the high rate biomethanation of rice mill effluent in hybrid anaerobic bioreactors at KCAET Tavanur. He designed and developed lab scale bioreactors with rubber seed shell as matrix for cell immobilization and found that they performed equally good in comparison to a bioreactor with poly urethane matrix.

Goncalves *et al.* (2012) examined the treatment of raw Olive Mill Effluent (OME) in an anaerobic hybrid reactor. They operated the reactor at an OLR between 3.3  $\text{kg}\cdot\text{m}^{-3}\cdot\text{d}^{-1}$  and 8.0  $\text{kg}\cdot\text{m}^{-3}\cdot\text{d}^{-1}$ , for 300 days. They observed a biogas production of 3.16  $\text{m}^3\cdot\text{m}^{-3}\cdot\text{d}^{-1}$  at an OLR of 7.1  $\text{kg}\cdot\text{COD}\cdot\text{m}^{-3}\cdot\text{d}^{-1}$ . The reactor was

capable to digest an acid influent (pH = 4.7), revealing a high buffering capacity. The reactor was able to recover after an accidental overload, and the packing material on the top of the reactor prevented excessive loss of biomass. Thereby the anaerobic hybrid reactor was effective in maximizing bioenergy recovery from OME.

Kundu *et al.* (2012) studied the performance of hybrid anaerobic reactors operating at different temperatures (37, 45 and 55°C), at an organic loading rate of  $2.22 \text{ kg}\cdot\text{COD}\cdot\text{m}^{-3}\cdot\text{d}^{-1}$  and at an HRT of 5 days. The reactor when operated at 37°C showed the best performance as well as the most diverse microbial community.

Li *et al.* (2012) conducted the study on comparison of the removal of COD by two hybrid bioreactors at low and room temperature. They operated a low-temperature hybrid bioreactor (LTHB) at 4°C and a room-temperature hybrid bioreactor (RTHB) at 25°C. They could obtain a COD removal efficiency from 39.76% to 66.27% for LTHB and 81.85% and 94.78% for RTHB. They opined that microorganisms cultured at low temperature showed higher activities and adaptabilities compare to those cultured at room temperature.

Kundu *et al.* (2013) investigated the effect of changes in hydraulic retention time and organic loading rate on the performance of two hybrid reactors. They operated the two reactors at 37 and 55°C. The HRT was reduced stepwise, while OLR was increased along with influent COD at a fixed HRT until the performance of reactor deteriorated. Results revealed more diverse archaeal community in the reactor operated at 37°C compare to the reactor operated at 55°C at higher OLR and shorter HRT.

Narra *et al.* (2014) investigated the performance of four different packing media in lab scale anaerobic hybrid reactors, viz. gravel, pumice stone, polypropylene saddles and ceramic saddles. They operated these reactors in semi-continuous mode at varying OLR and HRTs between 3-15 days. They found that COD removal efficiency and methane yield were significantly higher for the pumice stone medium at 15 days HRT.

Wahab *et al.* (2014) evaluated the sequential operation of six lab scale hybrid anaerobic reactor using a lignocellulosic biomass as biofilm support. After a short acclimation phase of several days, all the reactors achieved start-up in less than one month. After a 3 month non-feeding period all the reactors were restarted-up successfully in only 15 days. Results revealed that biofilms conserved their biological activities during the last phase.

Systematic studies on anaerobic hybrid bioreactors for treatment of WCW could not be found. This indicated the necessity for conducting the present study.

## *MATERIALS AND METHODS*

## CHAPTER III

### MATERIALS AND METHODS

The methodology adopted and the instrumentation used to conduct the investigations on energy production from Waste Coconut Water (WCW) through high rate anaerobic treatment is described in this chapter.

#### 3.1 Physico-chemical characteristics

The following methods were adopted for estimating different physico-chemical characteristics of the wastewater samples and biogas.

##### 3.1.1 Total solids (TS)

Total Solids is a measure of the total suspended and total dissolved solids in wastewater. It is generally measured in  $\text{mgL}^{-1}$ .

Standard procedure given by the American Public Health Association were used to determine the total solids (APHA, 1989). A measured volume of well mixed sample was transferred to a pre-weighed dish and evaporated to dryness in a drying oven. The evaporated sample was subject to drying for one hour in the oven at  $103\text{-}105^\circ\text{C}$ . The dish was then allowed to cool in a desiccator and then weighed. The process of drying, cooling and weighing was iterated till concordant weights were obtained.

$$\text{TS} = \frac{W_1 - W_2}{\text{Sample volume, mL}} \times 1000 \text{ mg} \cdot \text{L}^{-1} \quad \dots 3.1$$

$W_1$  = Weight of the dried residue with dish, mg

$W_2$  = Weight of dish, mg

##### 3.1.2 Biochemical Oxygen Demand (BOD)

The amount of dissolved oxygen consumed by aerobic biological organisms to breakdown organic material present in a given water sample over a 5-day period of incubation at  $20^\circ\text{C}$ .

BOD test was conducted for five days by filling to overflowing 300 mL air tight BOD bottles with diluted sample and subjecting it to incubation at 20°C for 5 days in a BOD incubator. Water was diluted by adding 1 L of distilled water, 1mL each of phosphate buffer, MgSO<sub>4</sub> solution, CaCl<sub>2</sub> solution and FeCl<sub>3</sub> solution prepared by the standard procedures (APHA, 1989). The Dissolved Oxygen (DO) was measured in the initially and after incubation and the BOD<sub>5</sub> was computed by the relation:

$$\text{BOD}_5 = \frac{D_1 - D_2}{P} \text{ mg} \cdot \text{L}^{-1} \quad \dots 3.2$$

Where,

BOD<sub>5</sub> = Five day Biochemical Oxygen Demand, mg·L<sup>-1</sup>

D<sub>1</sub> = DO of diluted sample immediately after preparation, mg·L<sup>-1</sup>

D<sub>2</sub> = DO of diluted sample after 5 days incubation at 20°C, mg·L<sup>-1</sup>

P = Decimal volumetric fraction of sample used



**Plate 3.1 BOD incubator**

### 3.1.3 pH value

The pH is defined as the negative logarithm of the hydrogen ion concentration. It is expressed mathematically as:

$$\text{pH} = -\log [\text{H}^+] \quad \dots 3.3$$

Where,

$$\text{H}^+ = \text{hydrogen ion concentration in mol}\cdot\text{L}^{-1}$$

The pH values of the samples were estimated by using the electronic method (APHA, 1989). The pH meter used was Systronics make, model  $\mu$  pH system 361 (plate 3.2). The specifications are given below:

Range	: 0-14 pH
Resolution	: 0.01 pH
Stability	: 0.01 pH.h <sup>-1</sup>
Power	: 230 V AC $\pm$ 10%, 50 Hz
Dimensions	: 250 (W) $\times$ 205 (D) $\times$ 75 (H) mm
Weight	: 1.25 kg (Approx)

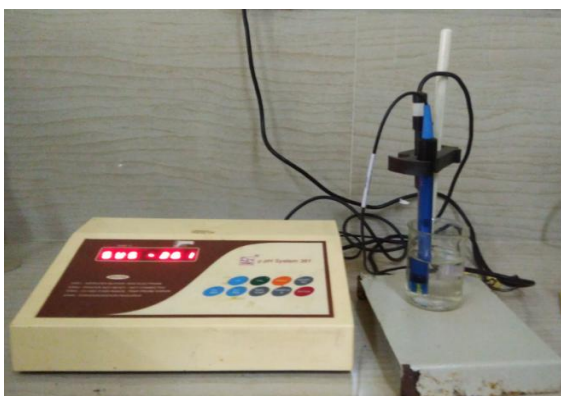

**Plate 3.2 pH meter**

### 3.1.4 Estimation of Total organic Carbon (TOC)

The estimation of TOC was done following the wet digestion method of Walkely and Black as described by Piper (1996). The diluted 10 mL sample was digested with 10 mL of 1 N  $K_2Cr_2O_7$  with 20 mL of concentrated  $H_2SO_4$  in 500 mL conical flask. The flask was kept on an asbestos sheet for about 30 minutes to complete the digestion. Then 200 mL of water is added to the flask. 3 to 4 drops of ferroin indicator is added and then the solution is titrated with 0.5 N Ferrous Ammonium Sulphate (FAS).

$$TOC, \% = \frac{(Bv - Sv) \times NFAS \times 100 \times 0.003}{V_s} \quad \dots 3.4$$

Where,

- Bv = Blank titre value
- Sv = Sample titre value
- NFAS = Normality of FAS
- Vs = Volume of sample

### 3.1.5 Total Kjeldahl Nitrogen (TKN)

The estimation of available nitrogen was done in the sample by micro-kjeldahl method. To 1 mL of sample, 2-3 mL of 25%  $KMnO_4$  solution was added followed by few drops of concentrated  $H_2SO_4$ . To this 10-15 mL of diacid ( $H_2SO_4$  and  $HClO_3$  in the ratio 5:2) was added and digestion carried out in a kjel plus digestion unit. Five mL each of the digested sample was distilled with 20 to 50 mL of 40% NaOH and the distillate titrated against 0.05 N  $H_2SO_4$ .

$$TKN, \text{mg/L} = \frac{\text{Titre value} \times 14 \times \text{Volume of acid make up}}{\text{volume of acid pipetted}} \times 100 \quad \dots 3.5$$

## 3.2 Operating parameters of anaerobic systems

The different operational parameters of anaerobic systems used for the investigation are described below:



### 3.2.1 Gas volume

The volume of gas produced was measured daily using wet type gas flow meter (Insref, India). The gas flow meter used for the purpose is shown in Plate 3.3. The specifications are given below:

Capacity / revolution	: 1 L
Graduation	: 0.01 L
Minimum flow rate	: 3 L.h <sup>-1</sup>
Maximum flow rate	: 10 L.h <sup>-1</sup>
Accuracy	: ± 0.5
Pressure range	: 2" to 12" water gauge
Connections	: For upto 0.5" ID flexible piping



**Plate 3.3 Wet type gas flow meter**

The gas production was expressed using the following standard terminologies:

Daily biogas production	: Total gas produced in litres per day, L·d <sup>-1</sup>
Volumetric biogas production	: Total gas production per unit volume of digester, L·m <sup>-3</sup>
Specific gas production	: Total gas production in litres per kg Total Solids <sub>added</sub> , L·kg <sup>-1</sup> TS <sub>added</sub>
Biogas productivity	: Total gas production in litres per litre of feed, L·L <sup>-1</sup>

### 3.2.2 Methane content of biogas

The appraisal of the methane content of the biogas produced was done using sacharometer. A measured quantity of biogas was passed through the saturated KOH solution in the sacharometer. Methane gas is collected at the top of the sacharometer and CO<sub>2</sub> is absorbed by the solution. The methane content is calculated as follows:

$$\text{Methane content, \%} = \frac{100 \times \text{Volume of gas collected at the top}}{\text{Total volume of gas injected}}$$

... 3.6



**Plate 3.4 Sacharometer**

### 3.2.3 Hydraulic Retention Time (HRT)

The time period in days for which the feed material is retained in the digester is termed Hydraulic Retention Time. It is the ratio of digester volume to the volume of daily feed material.

### 3.2.4. Loading rates

The anaerobic systems are assessed based on loading rates. The terminology for loading rates are as given below:

Hydraulic Loading Rate : The volume of daily feed in litres per unit volume of digester,  $L \cdot m^{-3} \cdot d^{-1}$

Organic Loading Rate : The amount of organic matter fed per unit volume of digester per day, expressed as  $kg \cdot TS \cdot m^{-3} \cdot d^{-1}$ .

This can also be expressed as  $kg \cdot VS \cdot m^{-3} \cdot d^{-1}$  and  $kg \cdot BOD \cdot m^{-3} \cdot d^{-1}$

### 3.3 Preliminary biomethanation studies

Waste coconut water used in this investigation was collected from Edible Oil Mill, Pattambi. Semi-continuous digestion study was carried out in a lab scale floating gas holder digester to get information on the biomethanation characteristics of waste coconut water. The metallic floating gas holder digester had a working volume of 150 litres and was connected with the gas flow meter (plate 3.5).

#### 3.3.1 Digester start-up and operation

The digester was filled with WCW effluent from the full scale bioreactor which was collected from the up-flow anaerobic hybrid bioreactor installed at Edible Oil Mill, Pattambi. After 7 days the digester was run in semi-continuous mode of operation and was operated on 35, 30 and 25-day HRT. The TS and pH were noted for the influent and effluent once stable gas production was observed for each HRT at an interval of three days. The gas production was recorded daily.

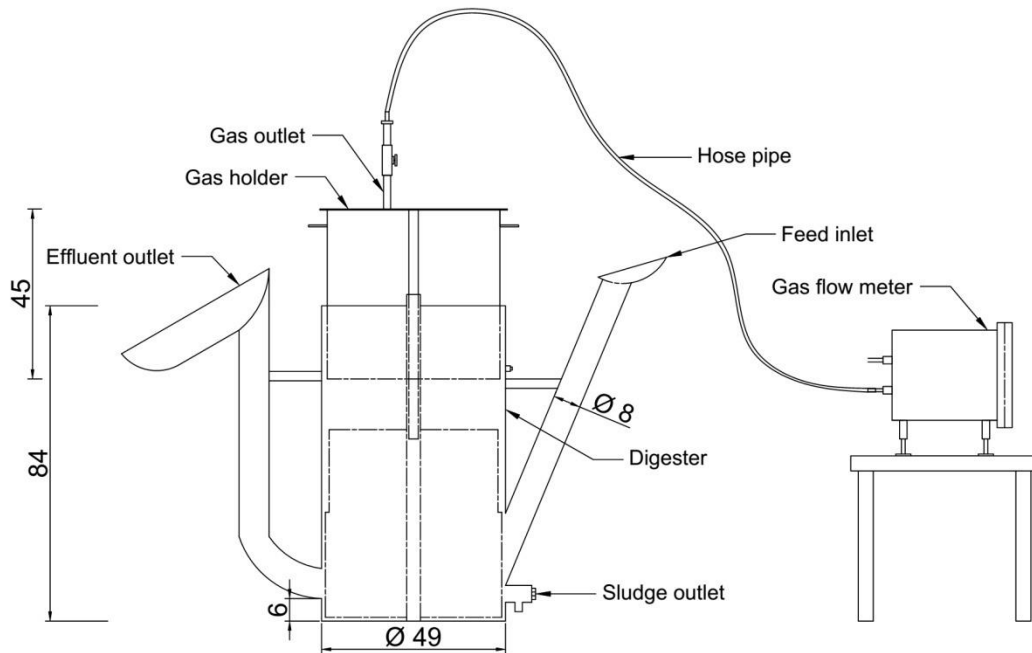

**Plate 3.5 Floating gas holder digester with wet gas flow meter installed at oil mill**

### **3.3.2 Dimensions of lab scale floating gas holder digester:**

The dimensions of lab scale floating gas holder digester and gas holder are given below:

Digester diameter	=	49 cm
Digester height	=	84 cm
Digester liquid volume	=	150 L
Gas holder diameter	=	46 cm
Gas holder height	=	45 cm
Gas holder volume	=	74 L
Sampling port	=	One sampling port was positioned at the middle of the digester



All dimensions are in cm

**Fig. 3.1 Schematic diagram of floating gas holder digester**

### 3.4 Study of full scale Up-flow Anaerobic Hybrid Bioreactor (UAHBR)

An existing full scale up-flow anaerobic bioreactor installed at Edible Oil Mill, Pattambi was made up of concrete and the WCW produced there was used in this study.

#### 3.4.1 Configuration of full scale UAHBR

The UAHBR had a total volume of 1.15 m<sup>3</sup> with a liquid volume of 1 m<sup>3</sup>. The upper 60% of the reactor volume was filled with coconut shell media with a porosity of 0.75%. The system had a separate gas collection unit with a masonry cylindrical tank and a Fibre Reinforced Plastic (FRP) gas holder.

The dimensions of existing UAHBR digester and gas holder are given below.

Internal Diameter of the digester	= 80 cm
Height of the digester	= 225 cm
Diameter of the gas holder tank	= 105 cm
Height of the gas holder tank	= 90 cm
The media height, as percentage of reactor height	= 60 %

#### **3.4.1.1 Feed inlet, Effluent Outlet and Sampling port**

The feed inlet was provided at the bottom of the reactor so that the chances of blockages and channeling by sludge was minimised and uniform mixing of feed was achieved.

20 mm PVC pipe were used for effluent outlet and was positioned above the media level. The outlet pipe was given a 'U' shape in the portion emerging out in order to avoid escape of gas. A sampling port was positioned at the middle of the reactor.

#### **3.4.1.2 Media placement and Dispersion plate**

The media used was coconut shells broken to pieces having an approximate size ranging from 40 to 100 mm. A dispersion plate was fixed in the two third portion of the reactor to keep the media at position in the reactor, and to enable uniform dispersion and flow of feed through the media.

#### **3.4.1.3 Feed pumping system**

A gear pump was used for pumping the WCW to the bioreactor and bypass valve was provided to adjust the flow rate of the influent.

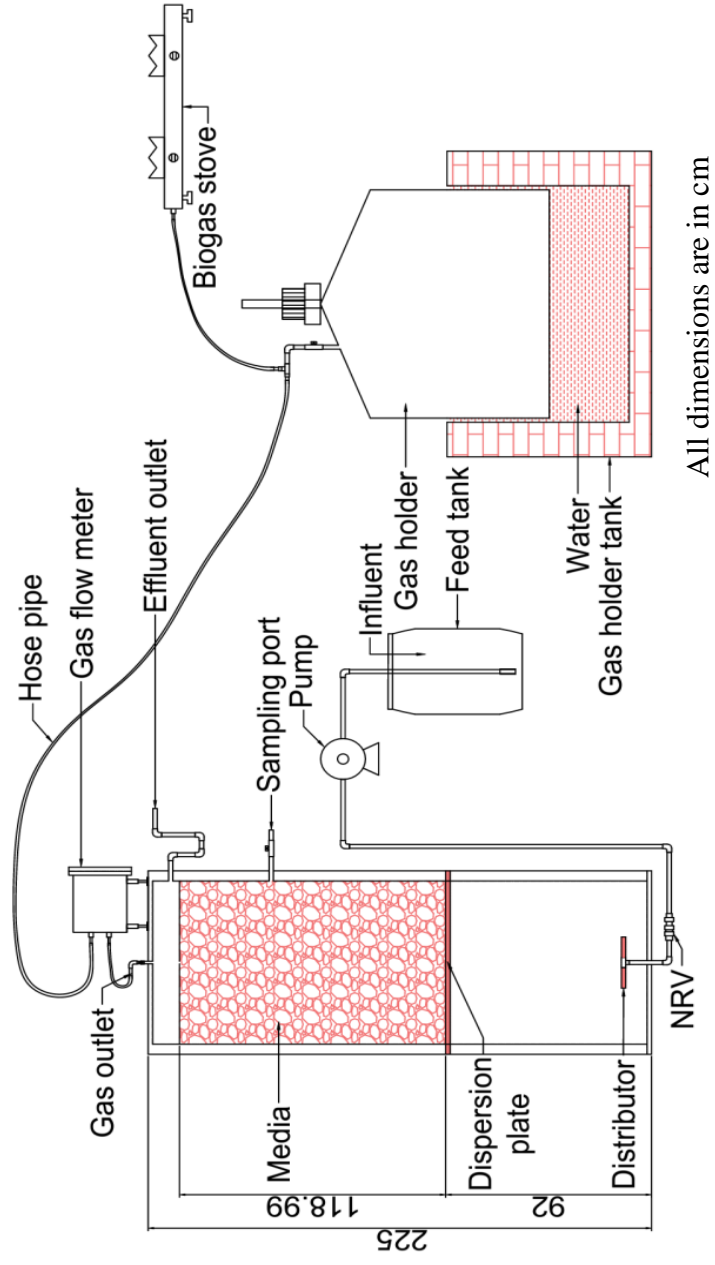

All dimensions are in cm

**Fig. 3.2 Schematic diagram of full scale UAHBR**



**Plate 3.6 Full scale UAHBR installed at Edible Oil Mill, Pattambi**

### **3.4.2 Study of full scale UAHBR**

The UAHBR which was installed at Edible Oil Mill, Pattambi is working there for more than two years. But sufficient scientific data was lacking as the system was being operated at an unknown HRT with varying hydraulic loading rates. The feeding was intermittent at varying intervals of 2-4 days. Hence it was decided to initially operate it by feeding 60 litres of CWC daily depending on the steady availability of CWC. The corresponding HRT was 16.67 days. Thereafter the HRT was reduced to 15 days and operated for 45 days to attain a pseudo-steady state condition. The observations for four weeks at pseudo-steady state condition was recorded. There after sufficient WCW was not available in the coconut oil mill to further operate the system at reduced HRTs, as production of oil varied due to market fluctuations.



### **3.5 Design, Fabrication and installation of experimental UAHBR**

The procedure for fabrication and installation of the experimental up-flow anaerobic hybrid bioreactor is given below:

#### **3.5.1 Selection of reactor configuration**

As there is little possibility to vary the operating conditions to the required extent in the case of full scale UAHBR it was decided to fabricate experimental bioreactors with similar configuration.

#### **3.5.2 Media placement**

It was decided to place the coconut shell broken pieces (media) on the upper half of the reactor height, leaving 20 cm at the top from the liquid surface (James and Kamaraj, 2003<sup>a</sup>).



**Plate 3.7 Broken Coconut shells used as media for bio-film growth**

#### **3.5.3 Estimation of media characteristics**

The procedure resorted to for the estimation of specific surface area, porosity and bulk density for coconut shells were as follows:

### 3.5.3.1 Specific Surface Area

For ascertaining the specific surface area of the media, 10 coconut shells were selected at random and broken to required size. The surface boundary of broken pieces of coconut shells were plotted on a graph paper. The graph paper was then subject to scanning and imported into a computer software (autocad) in order to calculate the surface area. The mean surface area was then found.

A known number of shells were selected randomly, broken to required size and then filled in a cylindrical vessel of diameter 3050 mm, in order to estimate the bulk volume, mL.

Specific surface area ( $A_{sp}$ ),  $m^2 \cdot m^{-3}$

$$= \frac{\text{Mean surface area of one broken shell} \times \text{No. of broken shells in the vessel}}{\text{Bulk volume of broken shell}} \quad \dots 3.7$$

### 3.5.3.2 Porosity of media

For ascertaining the porosity, broken coconut shells were filled in a cylindrical vessel. The vessel with media was then filled with water so as to make the media fully submerged.

$$\text{Porosity of media, \%} = \frac{\text{Volume of water filled, mL}}{\text{Volume of vessel, mL}} \times 100 \quad \dots 3.8$$

### 3.5.3.3 Bulk density

The bulk density was estimated by determining the weight of a known volume of broken shells.

$$\text{Bulk density, } kg \cdot m^{-3} = \frac{\text{Mass of broken coconut shell, kg}}{\text{Volume of broken coconut shell, } m^{-3}} \quad \dots 3.9$$

### 3.5.4 Dimensions of experimental UAHBR

The base data adopted for arriving at the dimensions of the experimental UAHBR is given below:

Design HRT (minimum)	= 6 day
Design media height, as percentage of reactor height	= 38 %
Design daily feed for 6 day HRT	= 21.66 $L \cdot d^{-1}$

It was decided to fabricate the bioreactor with PVC pipes of internal diameter 3050 mm and 5 mm thickness. Thus the diameter of the bioreactor was 305 mm and the height was 2030 mm.

Reactor height where no media is filled	= 126 cm
Reactor height where media is filled	= 77 cm
Liquid volume of the reactor (V)	= 130 L
Height of the liquid level above the media filled portion	= 20 cm

#### **3.5.4.1 Feed inlet, Effluent Outlet and gas outlet**

The feed inlet used was 20 mm tank connector with PVC pipe fittings provided at the bottom of the reactor and was fixed to the distributor so that the chances of blockages and channeling by sludge was minimised and uniform mixing of feed was achieved.

The effluent outlet had a size of 20 mm and was positioned above the media level. The outlet pipe was given a 'U' shape in the portion emerging out in order to avoid escape of gas.

The gas outlet of size 20 mm was fitted with a PVC ball valve and was fixed at the top end which was connected to the gas flow meter with help of garden hose pipe of 15 mm diameter.

#### **3.5.4.2 Fabrication of experimental UAHBR**

The experimental UAHBR was fabricated in the workshop attached to Kelappaji College of Agricultural Engineering and Technology, Tavanur. PVC pipes of diameter 3050 mm (ID) was selected for fabrication. Two end caps were fixed on top and bottom. The feed inlet was fabricated for uniform distribution of feed and was fixed to the bottom end cap. In the middle of the pipe a 20 mm thick perforated plate was placed. Then the media was placed up to the required level.



**Plate 3.8 Experimental UAHBR installed at Nila Oil Mill, Kuttippuram**

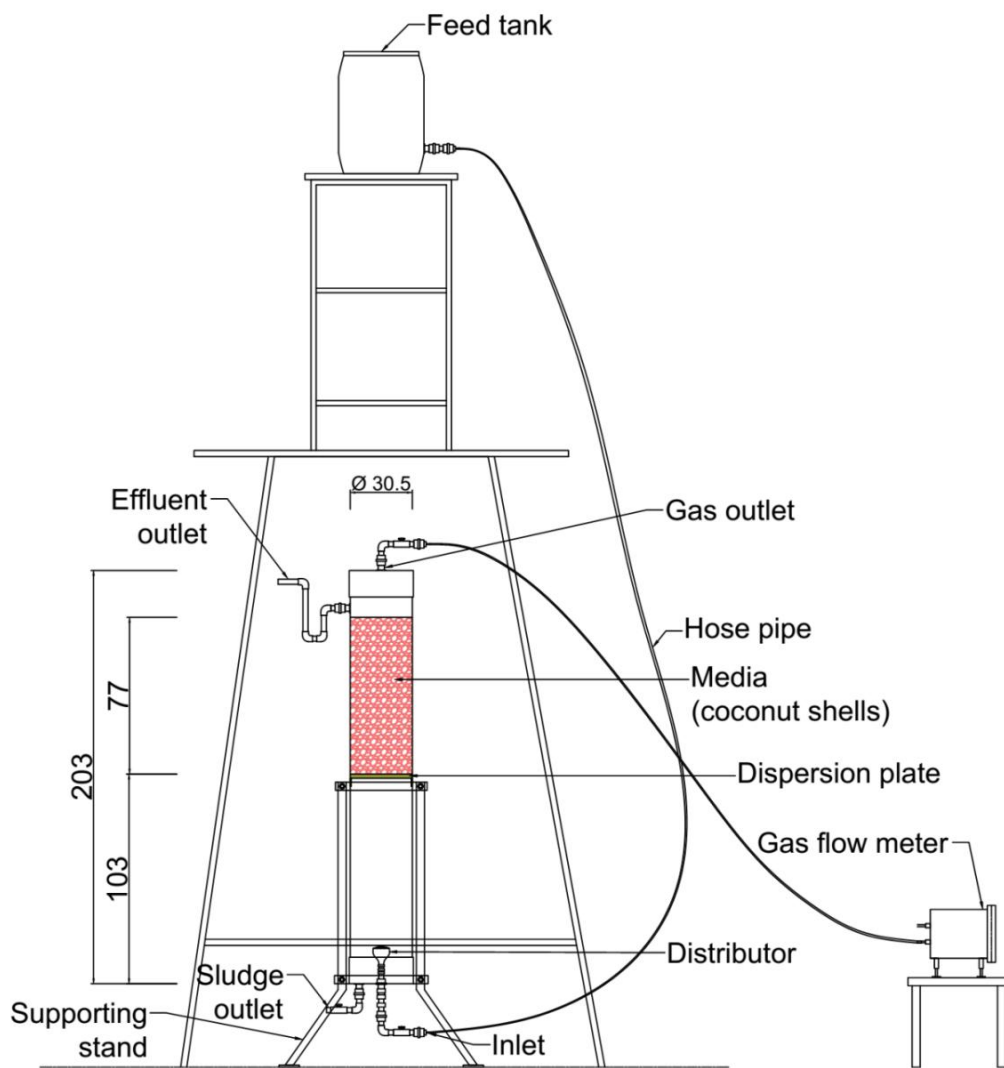

All dimensions are in cm

**Fig 3.3 Schematic diagram of experimental UAHBR**

### **3.6 Performance evaluation of experimental UAHBR**

The bioreactor was started up using sludge containing WCW taken from the full scale UAHBR. The UAHBR was observed for initial gas production and daily feeding was commenced on the 11<sup>th</sup> day. On prolonged operation of bioreactors the variation of biomass accumulation will be negligible when compared to the biomass content in the bioreactor and at this condition the reactor performance can be referred as pseudo-steady state. The start-up HRT was 15 days and once pseudo-steady state was attained, the loading rate was increased to operate the system at different HRTs. The experimental UAHBR was evaluated by operating at 15, 12, 10, 8 and 6 days after start-up.

## *RESULTS AND DISCUSSION*

## CHAPTER IV

### RESULTS AND DISCUSION

The results of the investigations carried out to study the physico-chemical characteristics of waste coconut water (WCW), preliminary biometanation study, performance evaluation of the full scale Up-flow Anaerobic Hybrid Reactor (UAHBR), start-up and performance of experimental UAHBRs are presented and discussed in this chapter.

#### 4.1 Physico-chemical characteristics of WCW

The WCW samples were analysed for different physico-chemical parameters and the results are shown in Table 4.1. WCW was found to be a medium strength waste water with TS, BOD and pH values in the ranges of 42300-47200 ( $\text{mg}\cdot\text{L}^{-1}$ ), 28725-29230 ( $\text{mg}\cdot\text{L}^{-1}$ ) and 3.24-4.77 respectively. The BOD value is comparable with the values reported by Smith and Bull (1976) and Sison (1977). The values of TS and pH are comparable with the values reported by Tripetchkul *et al.* (2010). Najafpour *et al.* (2006) reported BOD and pH values in the ranges of 23,000-26,000  $\text{mg}\cdot\text{L}^{-1}$  and 3.8 - 4.4 respectively, for palm oil effluent. In the present study the BOD value was slightly higher, the pH was within the range of reported value. The carbon: nitrogen (C:N) ratio was found to be 12.5 to 13.5 : 1. The nitrogen content value was found to be higher compared to the value recommended by Mathur and Rathore (1992).

**Table 4.1 Characteristics of WCW**

Sl. No.	Parameters	Values
1.	Total Solids (TS), $\text{mg}\cdot\text{L}^{-1}$	34729-44399
2.	Biochemical Oxygen Demand (BOD), $\text{mg}\cdot\text{L}^{-1}$	28725-29230
3.	pH	2.90-4.0



## **4.2 Biomethanation Characteristics of Waste Coconut Water (WCW)**

The anaerobic treatment of organic effluents depends on the characteristics of the feed material, loading rates and design of bioreactors. The results of investigations on anaerobic digestion of WCW depicting the biomethanation characteristics are presented in this section.

### **4.2.1 Semi-continuous digestion of WCW in a floating gas holder type digester**

The semi-continuous anaerobic digestion of WCW was carried out to assess the scope for biomethanation of WCW in a lab scale floating gas holder type digester as described in section 3.3. The digester was filled with secondary sludge obtained from the operational UAHBR for start-up. The digester was started up at 35-day HRT after charging it with effluent from the existing bioreactor. The gas production started from the next day onwards.

#### **4.2.1.1 Performance of floating gas holder digester during 35-day HRT**

The floating gas holder digester was operated for 6 weeks at 35-day HRT. The operational and performance parameters of during the period are shown in Table 4.2.

From Table 4.2 it is very clear that the influent had a very low pH in the range of 2.94-3.26 and was highly acidic. Even though there was an initial biogas productivity of  $2.79 \text{ L}\cdot\text{L}^{-1}$  in the first week, the biogas productivity started deteriorating to reach the minimum value of  $1.05 \text{ L}\cdot\text{L}^{-1}$  during the fourth week. The effluent pH was also in the acidic range showing decreased activity of methanogenic bacteria. It was also found that the TS reduction was also varying much. There after there was a slight improvement in the performance and the digester seemed to be stabilised to some extent as indicated by the TS reduction of 30-32 percent during 3<sup>rd</sup> week to 6<sup>th</sup> week. Biogas productivity reached  $2.48 \text{ L}\cdot\text{L}^{-1}$  during sixth week showing better stability.

**Table 4.2 Performance parameters of floating gas holder digester at 35-day HRT**

Week	pH		TS, mg L <sup>-1</sup>		Mean Daily Biogas production, L	TS Reduction, %	Biogas productivity, L L <sup>-1</sup>
	Influent	Effluent	Influent	Effluent			
1	3.14	4.38	34552.67	25082.0	12.02	11.85	2.79
2	3.15	4.17	40742.50	19579.5	7.87	51.94	1.83
3	2.94	4.07	34729.00	23606.0	5.56	32.03	1.42
4	3.24	3.98	36363.00	25460.0	4.51	29.98	1.05
5	3.26	3.95	39005.25	27117.0	7.70	30.47	1.79
6	3.18	3.97	37234.33	27336.6	10.67	26.58	2.48

The daily variation of influent and effluent pH along with the daily biogas production over a period of 6 weeks is depicted in Fig. 4.1. It is clear that there is a profound effect of influent pH over the working of the digester. During the period of 30-40 days, there was some improvement in the pH of the feed WCW and a resulting improvement in gas production also can be observed.

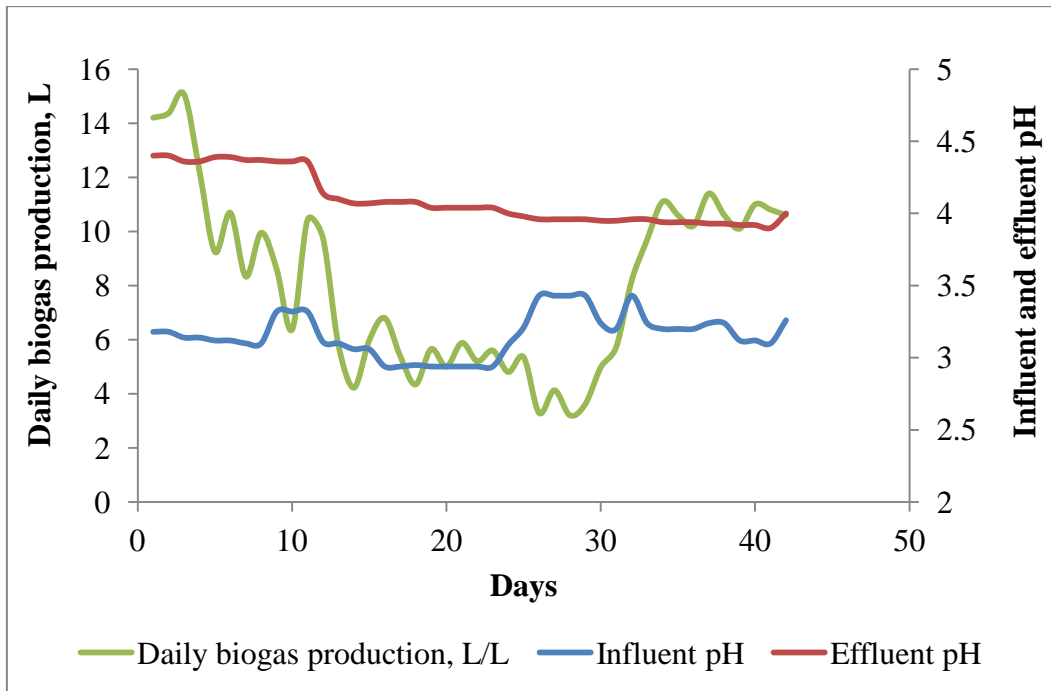

**Fig. 4.1** Variation of pH and daily biogas production during 35-day HRT

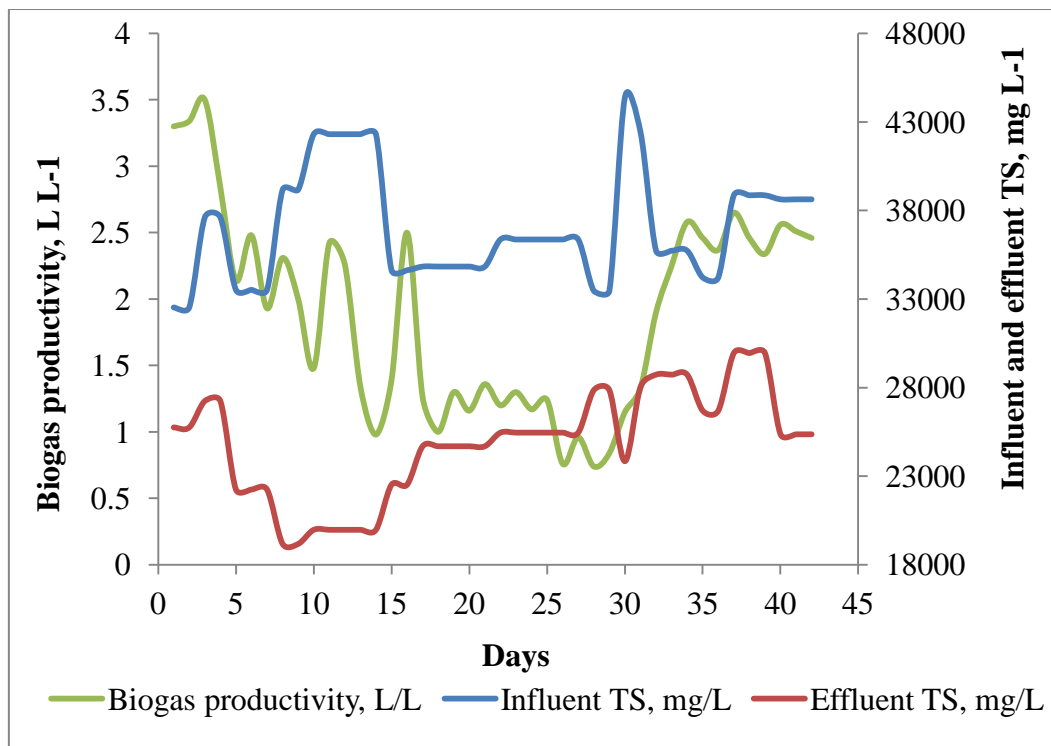

**Fig. 4.2** Variation of TS and biogas productivity during 35-day HRT

The variation of influent and effluent TS along with biogas productivity of WCW is depicted in Fig. 4.2. During the initial period, there was much variation in the influent as well as effluent TS. The variation of biogas productivity also was observed to be varying between 1.05 and 2.79 L·L<sup>-1</sup>. During the period after 17 days better stability of the system was observed, even though the biogas productivity was slightly lower. From day 30 onwards the biogas productivity was seen to increase slightly and remain high, even though influent TS and effluent TS varied irregularly showing better stability of the system.

#### 4.2.1.2 Performance of floating gas holder digester during 30-day HRT

During the 30 day HRT period also the influent was highly acidic having a low pH in the range of 3.19-3.48 (Table 4.3). Even though the effluent pH was also in the acidic range, there was a slight improvement in biogas production during the initial period, showing improved activity of methanogenic bacteria compared to 35 day HRT. It was also found that the biogas production started deteriorating to reach the minimum value of 10.19 L during the sixth week. The effluent was also acidic with the pH reducing to values lower than 4.

**Table 4.3 Performance parameters of floating gas holder digester at 30-day HRT**

Week	pH		TS, mg·L <sup>-1</sup>		Mean daily biogas production, L	TS reduction, %	Biogas productivity, L·L <sup>-1</sup>
	Influent	Effluent	Influent	Effluent			
1	3.22	4.19	38050.67	22588.00	18.97	40.63	3.77
2	3.25	4.32	38692.67	29748.00	11.54	23.11	2.36
3	3.39	4.21	43114.50	29959.50	11.08	30.51	2.22
4	3.48	4.09	41962.67	30780.67	10.31	26.64	2.06
5	3.29	3.99	40015.50	29870.00	10.67	25.35	2.13
6	3.19	3.90	39944.33	30402.67	10.19	23.88	2.05

From Fig. 4.3 it is clear that influent pH was acidic in nature and varied from 3.09-4 during the entire period of operation. During the initial period some improvement in the effluent pH up to 16 days was seen and thereafter reduced to reach the minimum value of 3.89 on 42<sup>nd</sup> day. Daily biogas production was seen to reduce drastically during the initial period, thereafter little variation was observed and remained in the range of 9.71-11.64 L. There was not much variation in the influent pH during the operational period and effluent pH was observed to be reducing to reach the minimum value of 3.90 during the sixth week.

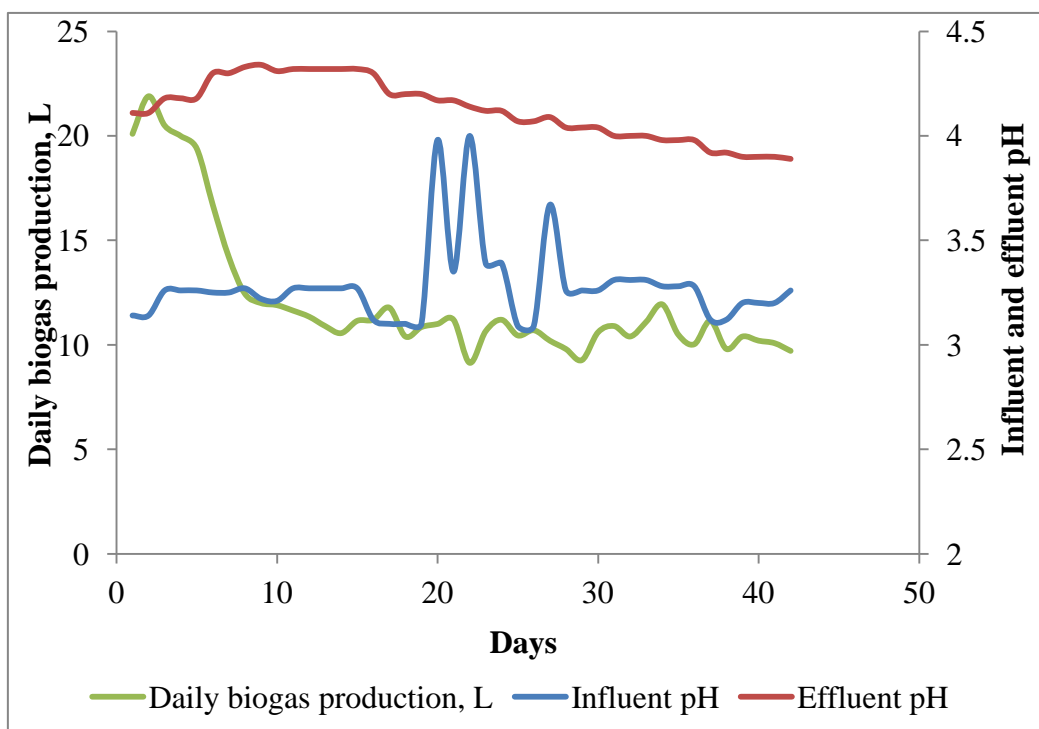

**Fig.4.3 Variation of pH and daily biogas production during 30-day HRT**

The daily variation of influent as well as effluent TS along with the biogas productivity over a period of 6 weeks is depicted in Fig. 4.4. There was a drastic reduction of biogas productivity during the period of 2-8 days. From day 10 the biogas productivity showed little variation and remained in the same range of about 2 L per L.

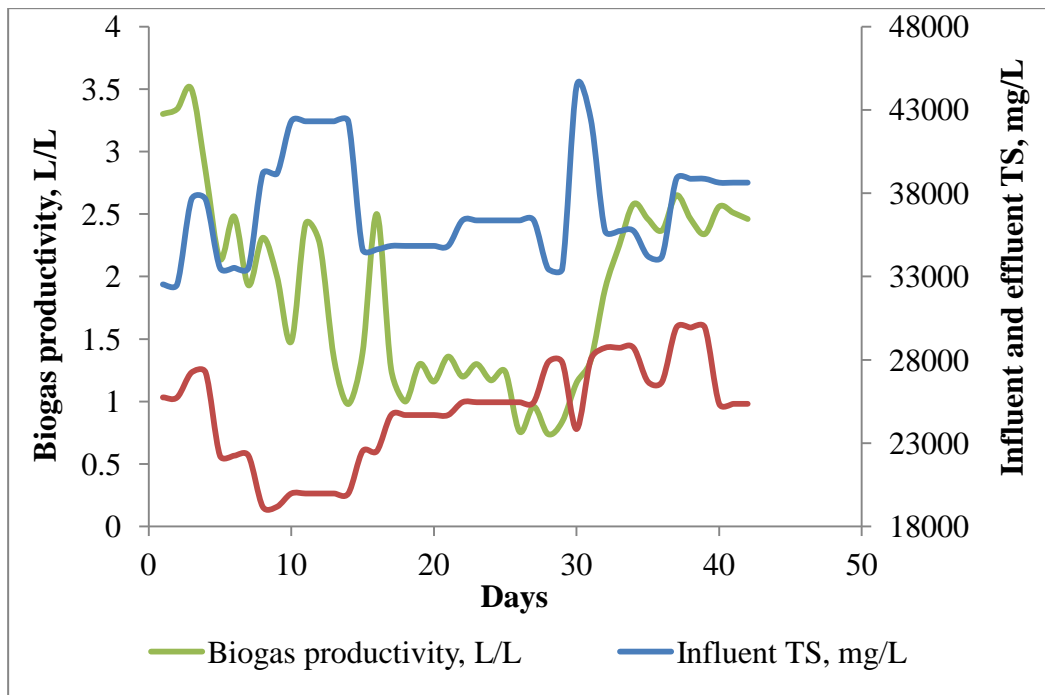

**Fig. 4.4 Variation of TS and biogas productivity during 30-day HRT**

#### **4.2.1.3 Performance of floating gas holder digester during 25-day HRT**

The variations of different operating parameters of the digester during 25 day HRT are depicted in Table 4.4. Even though there was some biogas production in the early days, it started reducing to low values from second week. The influent had a very low pH in the range of 3.18-3.33 and the effluent pH was also in the acidic range showing decreased activity of methanogenic bacteria. It was also found that the biogas production started deteriorating to reach the minimum value of 1.28 L during the fourth week. This is the clear indication of problems faced by conventional digesters when HRTs reduced.

**Table 4.4 Performance parameters of floating gas holder digester at 25-day HRT**

Week	pH		TS, mg·L <sup>-1</sup>		Mean daily biogas production, L	TS reduction, %	Biogas productivity, L L <sup>-1</sup>
	Influent	Effluent	Influent	Effluent			
1	3.26	3.81	37772	31754.00	8.07	16.16	1.38
2	3.18	3.62	37224	34265.67	4.24	7.97	0.71
3	3.33	3.45	37100	35669.00	2.15	3.85	0.36
4	3.23	3.39	37396	36878.50	1.28	1.38	0.22

From Fig. 4.5 it is seen that the influent pH varied from 3-3.5 during the entire period of operation. The effluent pH also observed to be very acidic and reached the minimum value of 3.38 on 26<sup>th</sup> day. During the period, daily biogas production was seen to deteriorate to reach minimum value of 1 L on 26<sup>th</sup> day. Thus the effect of shortened HRT was very evident and the anaerobic system was close to total failure.

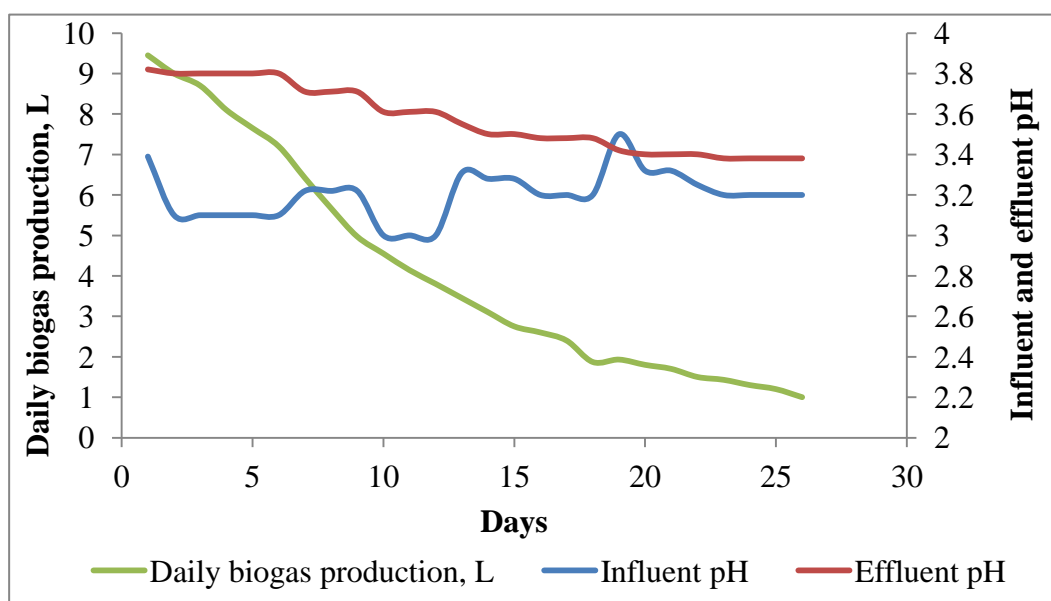

**Fig. 4.5 Variation of pH and daily biogas production during 25-day HRT**

The variation of influent as well as effluent TS along with the biogas productivity over a period of 4 weeks is depicted in Fig. 4.6. During the entire period of operation biogas productivity drastically reduced to reach the minimum value of 0.17 L.L<sup>-1</sup> on 26<sup>th</sup> day. The variations between influent and effluent TS were clear up to 13 days period of operation and there after not much variation was between influent and effluent. This shows reduced TS reduction, reduced biogas productivity and is the clear indication that the digester is going to fail.

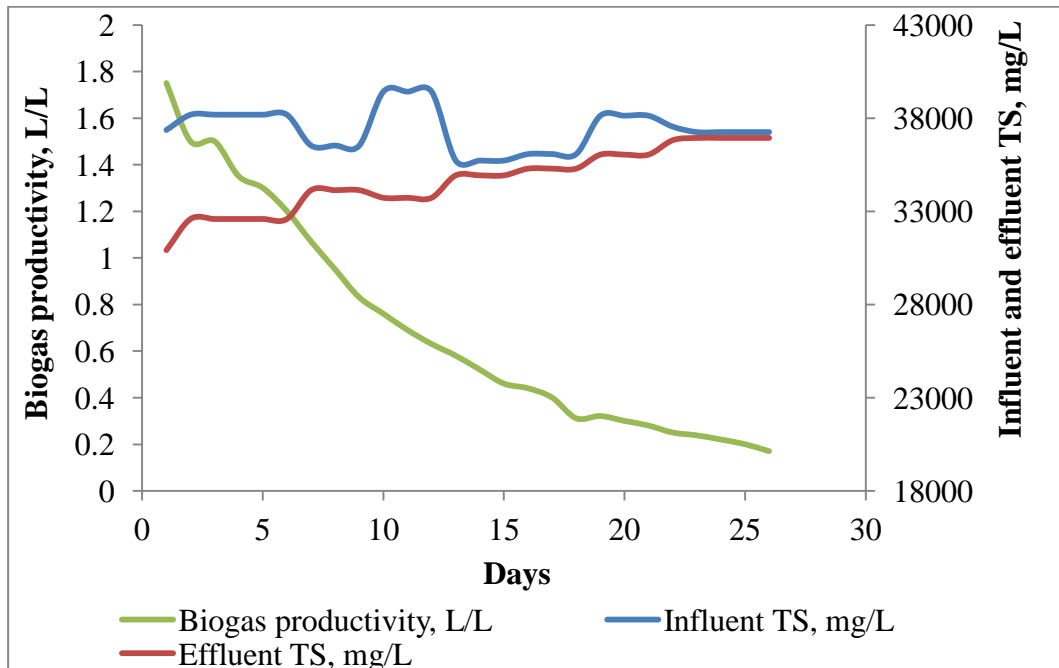

**Fig. 4.6 Variation of TS and biogas productivity during 25-day HRT**

#### 4.2.1.4 Performance of floating gas holder digester at varying HRTs

The study was continued for a period of 121 days till the biogas production became negligible. The initial and final parameters observed during the HRTs of 35, 30 and 25 days are shown in Table 4.5.

TS reduction was found deteriorating as the HRT was shortened from 35 to 25 days. This was a clear indication of the decrease in performance of the digester along with the reduction of HRT beyond limits.

The methane content of biogas has deteriorated from 62% to 49.33% during the 35 day HRT to 25 day HRT.



This shows the problems faced by a conventional biogas digester fed only on CWC which is inherently acidic. This is an example for failure of anaerobic systems due to unfavourable feed material coupled with wrong operating condition *ie.* short HRT or high HLR.

**Table 4.5 Operational parameters of WCW at different HRTs**

Parameters		HRT		
		35	30	25
TS, mg·L <sup>-1</sup>	Influent	32525-44399	36985-46598	36985-46598
	Effluent	19181-29947	19356-32963	30918-36941
	Reduction, %	11.85-51.94	23.88-40.63	1.38-16.16
pH	Influent	2.90-3.43	3.09-3.98	3.00-3.39
	Effluent	3.90-4.4	3.89-4.34	3.38-3.82
Biogas production	Daily biogas production, L	8.06	12.13	3.94
	Biogas productivity, L·L <sup>-1</sup>	1.89	2.43	0.67
CH <sub>4</sub> content		62	58.6	49.3

### 4.3 Performance evaluation of full scale UAHBR

The full scale upflow anaerobic hybrid bioreactor installed at the coconut oil mill and working for more than 2 years was studied to get a basic information on the process conditions. As there was little chance to alter the process conditions in the oil mill, initial studies were taken-up as it was run by the mill owner. They were feeding it irregularly and intermittently and hence the initial observations had no scientific value. Hence a regular feeding of 60 litres of WCW per day corresponding to a HRT of 16.67 days was done until a near steady state performance was observed.

### 4.3.1 Performance of UAHBR during initial operation

The UAHBR was operated at an HRT of 16.67 days for 3 weeks after attaining near-steady state performance. The salient results during this period of near-steady operation of the UAHBR are given in Table 4.6. Even though the weekly mean of influent pH were acidic and below 4 the effluent pH was in the range of 6.62 to 6.68 showing stable operation. The influent TS did not show wide variation over the period.

**Table 4.6 Influent and effluent characteristics during initial operation**

Weeks	pH (weekly mean)		TS, mg·L <sup>-1</sup> (weekly mean)	
	Influent	Effluent	Influent	Effluent
1	3.81	6.62	37737.50	8012.0
2	3.57	6.68	39010.33	7645.2
3	3.69	6.65	38373.92	7828.6

The performance of the bioreactor as indicated by biogas production and TS reduction over the three weeks period is depicted in Table 4.7. The high TS reduction of about 80 percent shows good performance of the bioreactor. The mean biogas productivity showed a slight improvement over the weeks reaching the high value of 13.16 L in the third week. The average biogas productivity of WCW was 12.6 L of biogas per litre of WCW. The specific biogas production was also good and the average value for the three weeks period was 321 L per kg of TS.

**Table 4.7 Performance parameters of UAHBR during initial operation**

Weeks	TS Reduction, %	Daily biogas production, L	Specific biogas production, litres/kg TS <sub>added</sub>	Biogas productivity, L·L <sup>-1</sup>
	(Weekly mean)			
1	78.75	716.0	316.23	11.93
2	80.39	768.5	328.52	12.81
3	80.24	789.6	320.62	13.16

The variation of influent and effluent pH and daily biogas production are depicted in Fig 4.7. The pH of the influent was in the range of 3.2 to 4.2. But the effluent was almost neutral with values ranging from 6.5 to 6.75. This showed the stable operation of the system. Acharya *et al.* (2008) have also reported that pH is the most important indicator to the stability of the system. The daily biogas production was nearly stable in the range 670 to 800 L during most of the period.

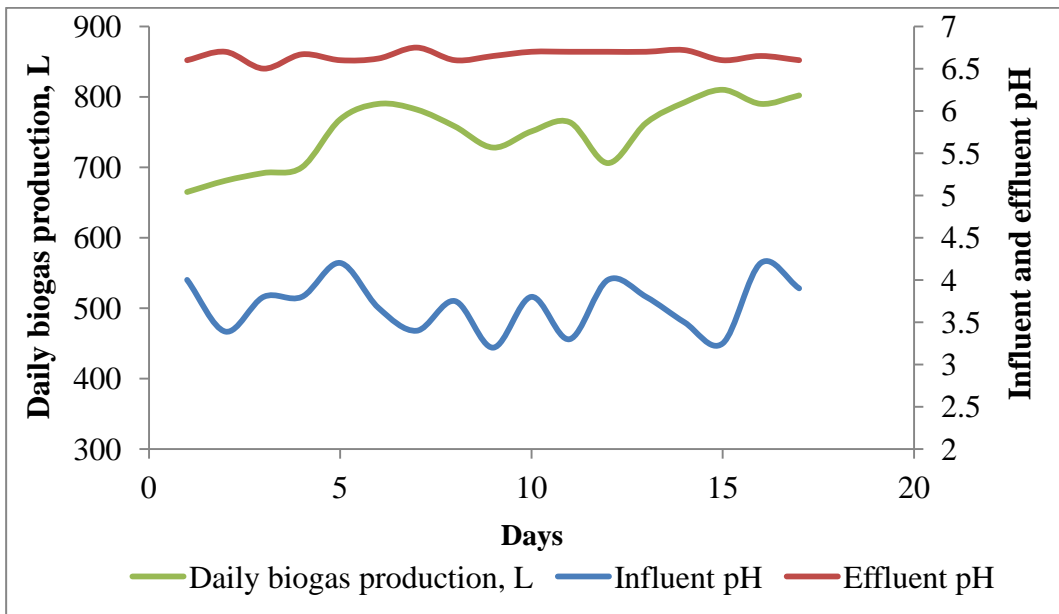

**Fig. 4.7 Variation of pH and daily biogas production during initial operation**

The reduction of TS coupled with specific biogas production is another important aspect indicating the stability and performance of anaerobic systems and these aspects of the UAHBR during the initial study period is depicted in Fig. 4.8. The TS reduction was observed to be high during the period and the mean reduction was 79.8 %. The variation of specific biogas production along with TS reduction is shown in Fig 4.8. James and Kamaraj (2004) reported a maximum TS reduction of 50 per cent, for cassava starch factory effluent lower than the value reported in the study. However in the present study TS reduction was high. Possibly due to the high biodegradability of WCW compared to cassava starch factory effluent.

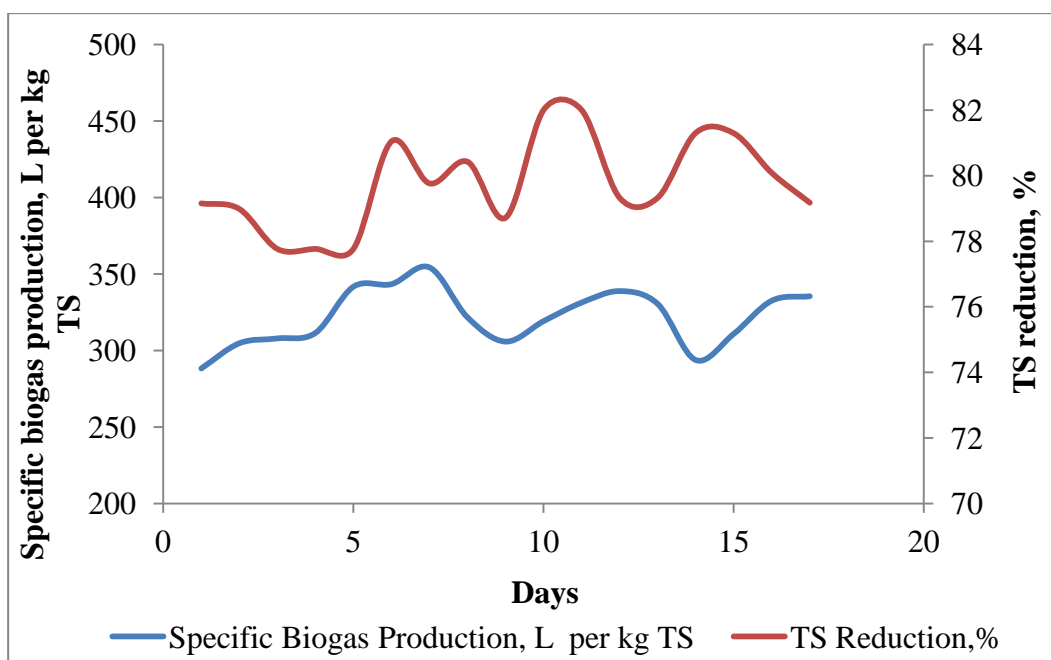

**Fig. 4.8 Specific biogas production and TS reduction during initial operation**

#### 4.3.2 Performance of full scale UAHBR at 15-day HRT

Once the bioreactor was stabilized at the reduced HRT of 15 days the performance parameters were recorded. The weekly mean values of various performance parameters are given in Table 4.8. The effluent pH was in the range of 6.55-6.67 during the entire period in spite of the low pH of influent below 4.

**Table 4.8 Influent and effluent characteristics during 15-day HRT**

Weeks	pH (Weekly mean)		TS, mg·L <sup>-1</sup> (Weekly mean)	
	Influent	Effluent	Influent	Effluent
1	3.24	6.57	37926.71	7880.28
2	3.25	6.55	39465.86	7780.57
3	3.44	6.55	39769.86	7642.71
4	3.70	6.67	40460.86	7517.14

The major performance parameters of the UAHBR are shown in table 4.9. TS reduction was 79.35% during first week and improved to reach 81.40% during the fourth week. James and Kamaraj (2009) reported a TS reduction of 60% while treating cassava starch factory effluent and this low TS reduction compared to the present study might be due to low strength of cassava starch factory effluent. The biogas productivity of WCW was observed to be 11.01 L·L<sup>-1</sup> during the first week and a gradual improvement was observed to reach 12.47 L·L<sup>-1</sup> during the fourth week. All the indicators viz. TS reduction as well as biogas productivity and specific biogas production were satisfactory and clearly denoted the stable operation of the system.

**Table 4.9 Performance parameters of full scale UAHBR at 15-day HRT**

<b>Weeks</b>	<b>Mean TS Reduction, %</b>	<b>Weekly mean daily biogas production, L</b>	<b>Mean specific biogas production, litres/kg TS<sub>added</sub></b>	<b>Mean biogas productivity, L·L<sup>-1</sup></b>
1	79.35	748.43	290.19	11.01
2	80.20	788.00	293.63	11.59
3	80.77	827.43	305.96	12.16
4	81.40	848.43	308.37	12.47

Fig. 4.9 shows steady performance of the UAHBR during 15 day HRT period. There was improved daily biogas production with gradual increase to reach about 850 L during the 4th week. The influent pH was below 4 but the reactor performed good without any problem. Acharya *et al.*, (2008) also reported that they used a feed having a pH of 4.5 without neutralization while treating distillery spent wash.

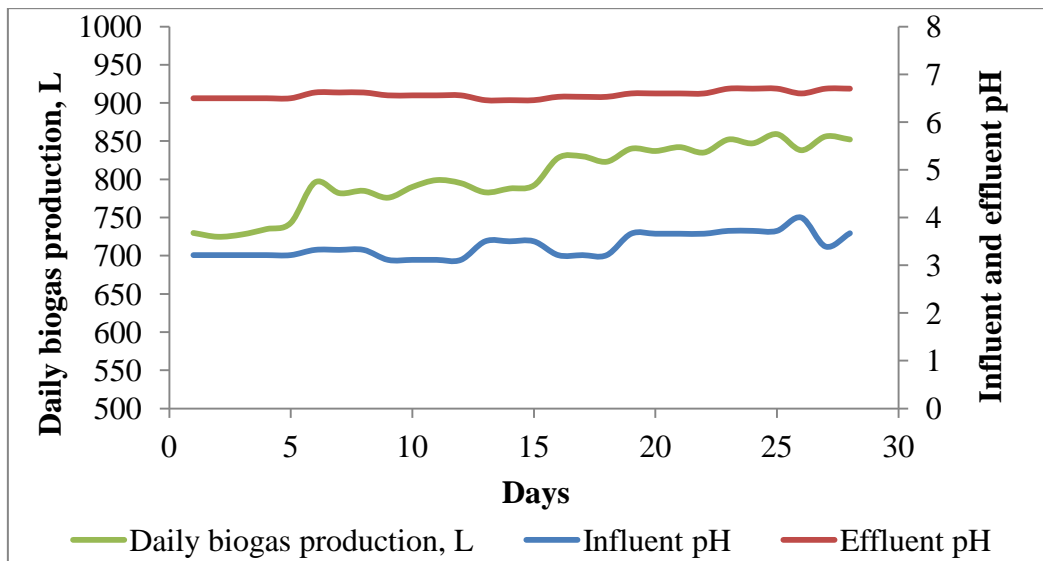

**Fig. 4.9 Variation of pH and daily biogas production during 15-day HRT**

The specific biogas productions along with TS reduction over the four weeks are shown in Fig 4.10. There is a slow and gradual improvement in the specific biogas production indicative of stable operation of the system, also depicting the gradual improvement in performance. The specific biogas production of 332 Lkg<sup>-1</sup>TS was obtained on 25<sup>th</sup> day of operation which is lower than the value reported by James and Kamaraj (2009). They reported a value of 1108 Lkg<sup>-1</sup>TS while treating cassava starch factory effluent and this may be due to the lower value of TS which is about one tenth of WCW.

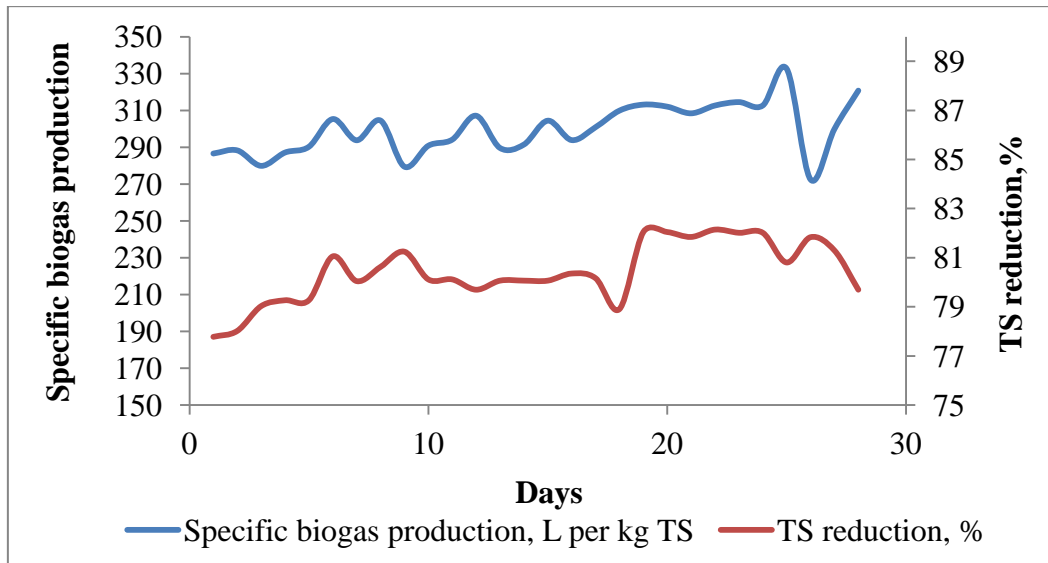

**Fig. 4.10 Specific biogas production and TS reduction during 15-day HRT**

#### 4.4. Installation and operation of experimental UAHBR

The experimental UAHBR was installed at the Nila oil mill, Kuttippuram. WCW produced at Nila oil mill was used for feeding the experimental UAHBRs. The reactor was fed from an overhead gravity feed tank and flow was adjusted by a control valve. The salient results of the studies conducted to understand the start-up of the experimental UAHBR and their performance during the HRTs of 15, 12, 10, 8 and 6 days are presented and discussed below.

##### 4.4.1 Characteristics of media

The physical characteristics of packing media (coconut shell) are shown in Table 4.10

**Table 4.10 Physical characteristics of packing media**

Sl. No.	Parameters	Value
1	Bulk density, $\text{kg}\cdot\text{m}^{-3}$	410.95
2	Porosity, per cent	67.56
3	Specific surface area, $\text{m}^2\cdot\text{m}^{-3}$	113.60

The broken coconut shells had a high bulk density compared to synthetic media like PVC pall rings, but had a reasonably high porosity, The specific surface area of coconut shell was  $113.6 \text{ m}^2 \cdot \text{m}^{-3}$  and is well above the recommended value of  $100 \text{ m}^2 \cdot \text{m}^{-3}$ . A rough and porous surface enhances the bio-film development in the digester (Acharya *et al.*, 2008; James and Kamaraj, 2004).

#### 4.4.2 Start-up of experimental UAHBR

The inoculum used for start-up was collected from the operational full scale UAHBR installed at Edible Oil Mill, Pattambi. For easy start up, 100 per cent of the total liquid volume of the experimental UAHBR was filled with effluent. The effluent used for charging the reactors had a TS of  $8324 \text{ mg} \cdot \text{L}^{-1}$  with a pH of 6.5. The reactor liquor was re-circulated daily for 10 days. Daily feeding of the UAHBRs was commenced on the 11<sup>th</sup> day from first charging of the UAHBR.

#### 4.4.3 Performance of experimental UAHBR at 15-day HRT

After start-up the bioreactor was run for 62 days at an HRT of 15 day. The influent characteristics and operating parameters are given in Table 4.11. The WCW had a low pH in the acidic range and the TS and BOD were comparatively high compared to rice mill effluent (Bovas, 2003) and sago factory effluent (James and Kamaraj, 2003).

**Table 4.11 Influent characteristics during 15-day HRT period**

Sl. No	Parameter	Quantity with unit
1	PH	2.8-5.6
2	TS	$36985\text{-}45230 \text{ mgL}^{-1}$
3	BOD	$26000\text{-}30300 \text{ mgL}^{-1}$



The weekly variations of influent and effluent characteristics are shown in Table 4.12. Influent pH ranged between 3.46-4.87 throughout the experiment. Effluent pH was 4.4 in the first week and improved to 6.86 during the 8<sup>th</sup> week. Goncalves *et al.* (2012) reported similar experience while treating olive mill effluent. Such an improvement in the reduction of effluent TS also can be observed from 6<sup>th</sup> week onwards.

**Table 4.12 Influent and effluent characteristics during 15-day HRT**

Week	pH (Weekly mean)		TS, mg·L <sup>-1</sup> (Weekly mean)	
	Influent	Effluent	Influent	Effluent
1	3.64	4.4	44369.22	10472.66
2	4.87	5.61	41582.39	10062.66
3	4.01	5.94	40309.58	9912.00
4	3.46	6.4	37028.58	8765.66
5	4.08	5.8	39598.45	9148.50
6	3.63	6.37	36832.32	8544.50
7	3.71	6.76	38008.03	7599.00
8	4.16	6.86	39683.21	7479.00
9	3.88	6.74	38537.34	7148.66

The major performance parameters of the bioreactor during the 15 day HRT period are shown in Table 4.13. A very high TS reduction of 81.45% was obtained on 9<sup>th</sup> week. James and Kamaraj (2009) studied the performance of up-flow anaerobic hybrid reactors for pollution control and energy production from cassava starch factory effluent and reported 60% TS reduction. The result shows that our reactor showed high TS reduction at same HRT. Specific biogas production as well as biogas productivity improved with the passage of time and was found to be in a near stabilised state from 7<sup>th</sup> week. But the biogas productivity and specific biogas production were less compared to the full scale UAHBR where 12.47 L·L<sup>-1</sup> and 308.37 Lkg<sup>-1</sup>·TS<sub>added</sub>, respectively, were observed. The full scale bioreactor performed better than the experimental bioreactor as it had been working for a long time with high accumulation of biomass.

**Table 4.13 Performance parameters of experimental UAHBR at 15-day HRT**

<b>Week</b>	<b>TS Reduction, % (Weekly mean)</b>	<b>Daily biogas production, L (Weekly mean)</b>	<b>Specific biogas production, litres/kg TS<sub>added</sub> (Weekly mean)</b>	<b>Biogas productivity, L.L<sup>-1</sup> (Weekly mean)</b>
1	76.39	40.47	105.69	4.66
2	75.80	56.84	157.66	6.56
3	75.41	62.80	179.69	7.35
4	76.32	67.73	210.97	7.82
5	76.90	60.36	175.81	6.97
6	76.80	68.71	215.17	7.93
7	80.00	73.50	223.05	8.47
8	81.15	75.04	218.12	8.65
9	81.45	75.42	225.73	8.70

The daily variation of influent and effluent pH along with the daily biogas production over a period of 62 days is depicted in Fig. 4.11. During the period effluent pH and biogas production seemed to improve with passage of time and getting stabilised in 6 weeks. It is clear that the methanogenic activity also was gradually improving to reach a biogas production 78 L on 58<sup>th</sup> day. It can also be noted that the biogas production is following the trend of effluent pH and exhibits the close relation between pH and methanogenic activity.

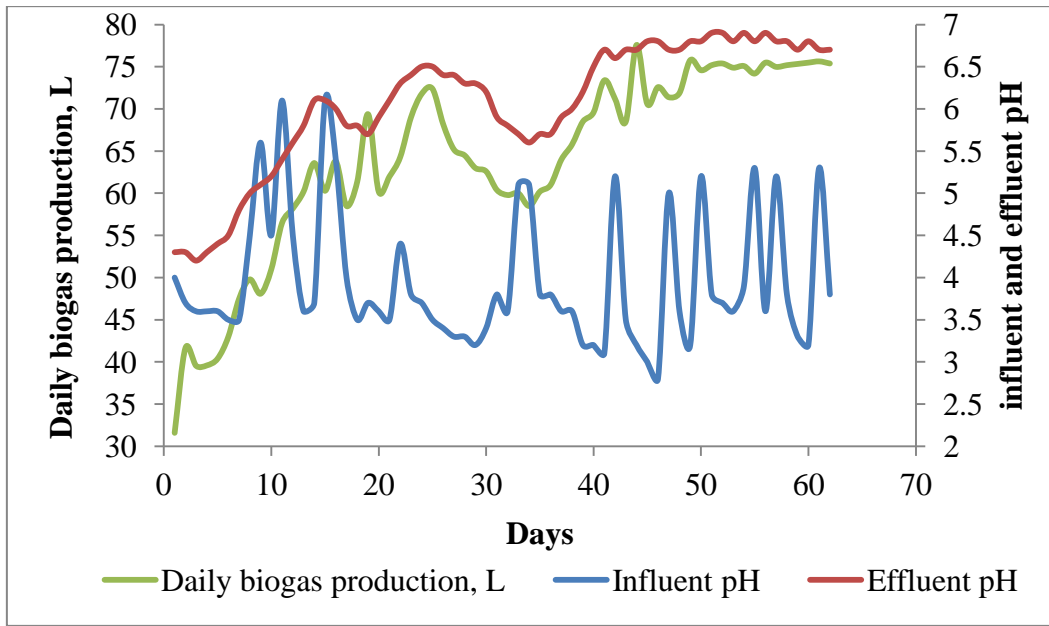

**Fig. 4.11 Variation of pH and daily biogas production during 15-day HRT**

#### 4.4.4 Performance of experimental UAHBR at 12-day HRT

The characteristics of influent CWC and the resulting effluent during bioreactor operation at 12 day HRT are given in Table 4.14. The influent pH remained in the acidic range where as effluent pH was above 6. During the initial period the effluent pH was slightly lowered and reached below 6.5 showing a slight reduction in performance. There after the system started picking up and the effluent pH reached values above 6.5. This showed the ability of the system to adjust to the changing shorter HRTs.

**Table 4.14 Influent and effluent characteristics during 12-day HRT**

Weeks	pH (Weekly mean)		TS, mg·L <sup>-1</sup> (Weekly mean)	
	Influent	Effluent	Influent	Effluent
1	4.17	6.10	37001.40	10585.00
2	3.99	6.12	38908.53	10436.33
3	3.96	6.33	38822.08	9776.33
4	3.95	6.55	38736.36	9338.50

The bioreactor performance parameters shown in Table 4.15 also conform to the slight deterioration during the early periods of changed HRT and stabilisation of bioreactor subsequently. The trend of biogas production indicated by weekly means of specific biogas production and biogas productivity exhibited the reduced performance during first two weeks and the regaining of bioreactor ability during third and fourth weeks.

**Table 4.15 Performance parameters of experimental UAHBR at 12-day HRT**

Weeks	TS Reduction, %	Daily biogas production, L	Specific biogas production, litres/kg TS <sub>added</sub>	Biogas productivity, L·L <sup>-1</sup>
	(weekly mean)			
1	71.39	70.21	174.88	6.48
2	73.18	73.53	174.18	6.78
3	74.82	81.14	192.63	7.47
4	75.89	85.88	204.34	7.91

Fig.4.12 further testifies the trend of reactor performance. The effluent pH values remained in the range of 6 and 6.6 during the period, but showing the trend of pH increase over the weeks. Narra *et al.* (2014) reported similar trend of effluent pH (6.9–7.1) while treating rice straw wastewater at 3-15 days HRT, which is favourable condition for methanogenic bacteria. During the period, daily biogas production seemed to follow the trend of reduction in acidity of the effluent indicating the gradual improvement of the system.

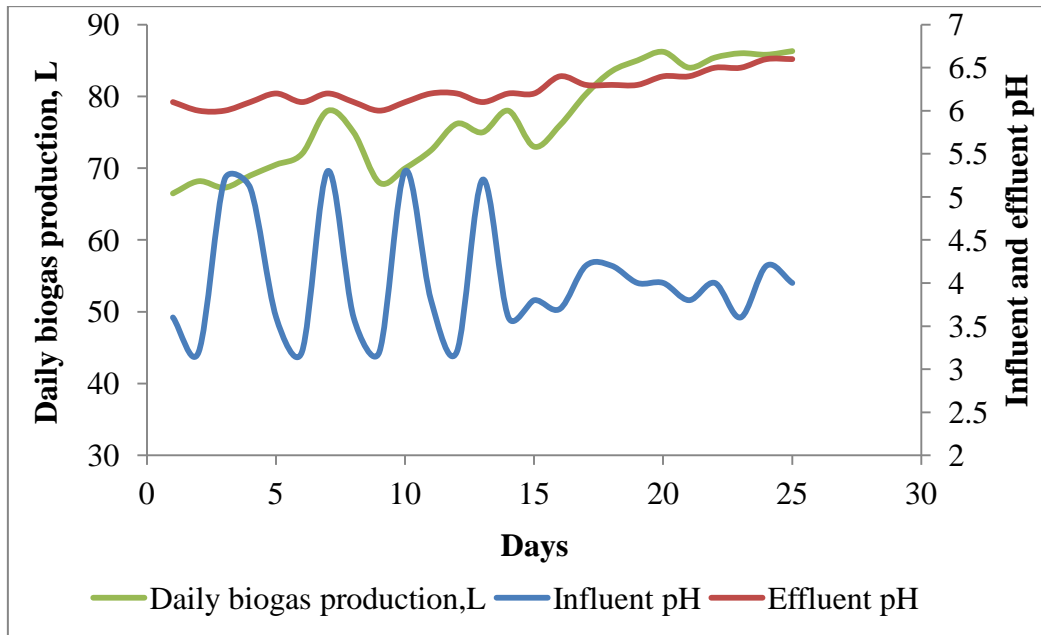

**Fig. 4.12 Variation of pH and daily biogas production during 12-day HRT**

#### 4.4.5 Performance of experimental UAHBR at 10-day HRT

The influent as well as the effluent TS and pH shown in Table 4.16 indicates that the biomethanation activity is not much affected by the changed HRT, even though there is a slight reduction in effluent pH. But it appeared that the reactor could not regain alkalinity as the effluent pH remained below 6.5 during most of the five weeks period.

**Table 4.16 Influent and effluent characteristics during 10-day HRT**

Weeks	pH (Weekly mean)		TS, mg·L <sup>-1</sup> (Weekly mean)	
	Influent	Effluent	Influent	Effluent
1	3.94	6.41	37952.25	12478.40
2	3.92	6.32	38574.24	12380.80
3	3.93	6.27	37630.83	12277.00
4	3.94	6.27	40612.51	12445.67
5	4.21	6.17	38746.00	12579.33

The performance indicators depicted in table 4.17 confirmed that the slight lowering of effluent pH has not affected the system considerably. The biogas productivity of above 7 LL<sup>-1</sup> was obtained during the period except first week. Bovas (2009) reported a biogas productivity of 3.9 LL<sup>-1</sup> while treating rice mill effluent at 11-day HRT which is much lower than the productivity of WCW observed in the present study. Specific biogas production as well as biogas productivity remained almost stable during the period.

**Table 4.17 Performance parameters of experimental UAHBR at 10-day HRT**

Weeks	TS Reduction, %	Daily biogas production, L	Specific biogas production, litres/kg TS <sub>added</sub>	Biogas productivity, LL <sup>-1</sup>
	(Weekly mean)			
1	61.76	90.47	183.37	6.95
2	62.20	95.30	190.04	7.33
3	67.32	96.54	201.23	7.43
4	64.46	93.17	174.70	7.17
5	62.51	91.04	180.74	7.00

Fig.4.13 illustrates the daily variation of influent and effluent pH along with daily biogas production during 10 day HRT period. The influent pH was observed to be acidic and varied erratically. But even though slightly in the acidic range, effluent pH remained in a balanced position between 6.1 and 6.6. Daily biogas production did not show any specific trend but was seen varying erratically within a narrow range.

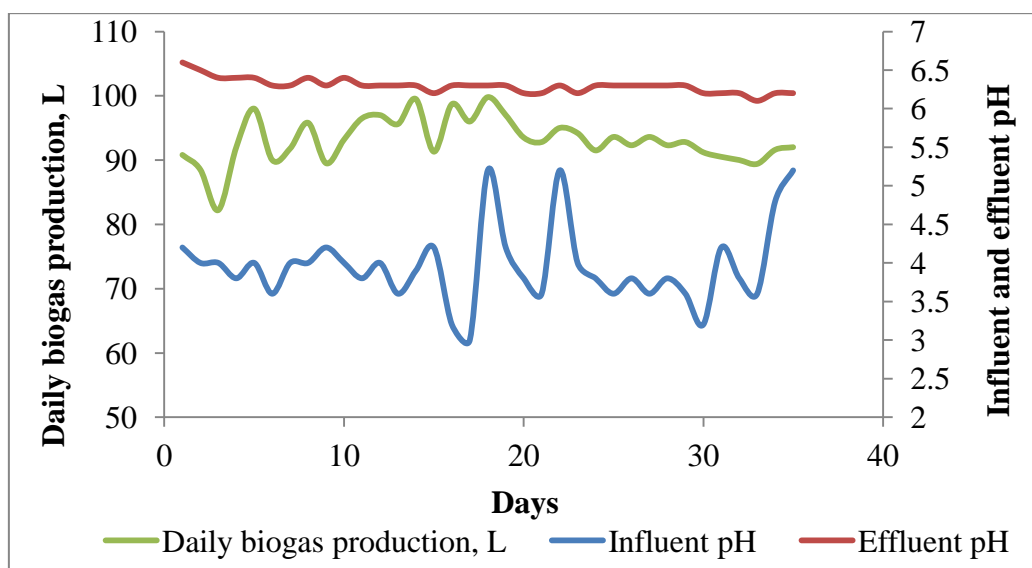

**Fig.4.13 Variation of pH and daily biogas production during 10-day HRT**

#### 4.4.6 Performance of experimental UAHBR at 8-day HRT

The characteristics of the influent WCW and that of the effluent emerging from the UAHBR are shown in Table 4.18. The effluent pH started declining to values below 6.3 from the first week itself and fell beyond 6 showing a decreased stability of the system.

**Table 4.18 Influent and effluent characteristics during 8-day HRT**

Weeks	pH (Weekly mean)		TS, mg·L <sup>-1</sup> (Weekly mean)	
	Influent	Effluent	Influent	Effluent
1	3.81	6.31	38696.37	18356.25
2	4.13	6.20	39167.57	18986.00
3	3.74	5.94	39806.66	19083.00
4	4.31	6.04	39316.90	18576.25

The performance parameters depicted in Table 4.19 is indicative of the reduced performance compared to 10 day HRT period. There was significant decline in TS reduction and was in the range of 52-53 %. James and Kamaraj (2009) reported the biogas productivity of 4.24 LL<sup>-1</sup> from cassava starch factory effluent. The biogas productivity of above 5.6 LL<sup>-1</sup> of WCW was obtained in this

study which is more than the reported value. The specific biogas production and biogas productivity are also following the similar trend during 8 day HRT period.

**Table 4.19 Performance parameters of experimental UAHBR at 8-day HRT**

Weeks	TS Reduction, %	Mean daily biogas production, L	Specific biogas production, L/kg TS <sub>added</sub>	Biogas productivity, LL <sup>-1</sup>
	(Weekly mean)			
1	53.00	104.20	165.71	6.48
2	52.00	100.00	154.74	6.15
3	52.06	92.51	142.32	5.69
4	52.75	96.94	151.93	5.97

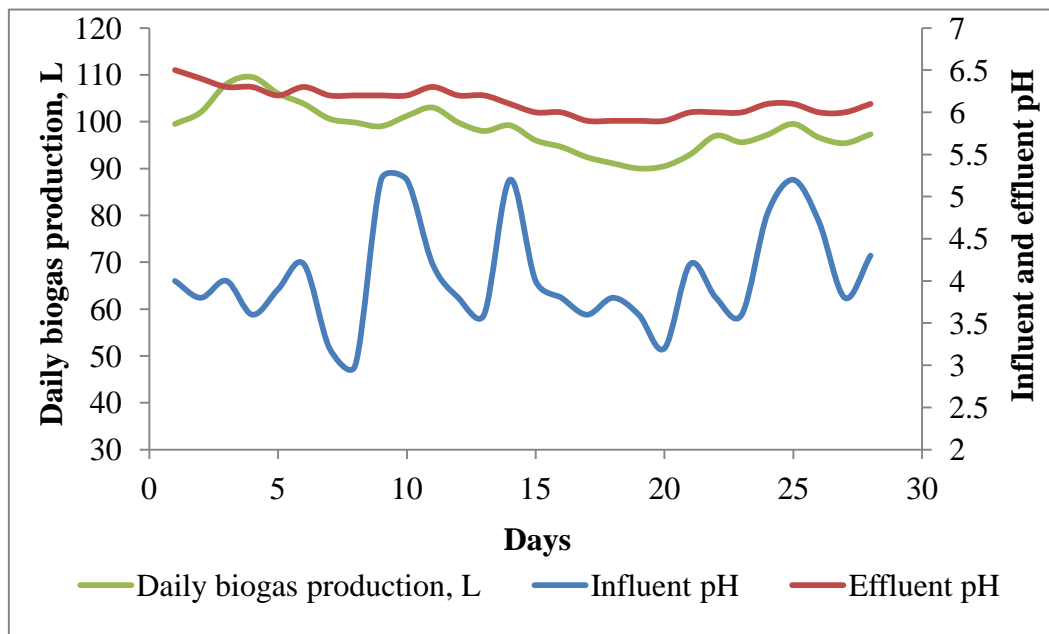

**Fig. 4.14 Variation of pH and daily biogas production during 8-day HRT**

Fig.4.14 shows the variation of influent and effluent pH along with daily biogas production. During the period, effluent pH was in the range of 5.9 and 6.5, even though the influent pH was in the range of 3 and 5.2. The effluent pH was observed to be slightly declining to reach the minimum value of 5.9 on the 18<sup>th</sup> day and remained near to 6 during the remaining period. Daily biogas production was also seen to be declining and followed the similar trend with effluent pH.



#### 4.4.7 Performance of experimental UAHBR at 6-day HRT

The characteristics of the influent and effluent from the UAHBR are shown in Table 4.20. The effluent pH started deteriorating to reach value of 5.74 from the first week and 5.20 during the second week showing a decreased stability of the system. Acharya *et al.* (2008) also experienced a similar trend while treating distillery spent wash. They reported that when the pH fell to 5 the reactor failed.

**Table 4.20 Influent and effluent characteristics during 6-day HRT**

Weeks	pH (Weekly mean)		TS, mg·L <sup>-1</sup> (Weekly mean)	
	Influent	Effluent	Influent	Effluent
1	4.18	5.74	37943	19986
2	3.77	5.20	37737	22407

The performance parameters shown in Table 4.21 also conform to the deterioration of the reduced performance compared to 8 day HRT period. There was considerable decline in TS reduction and was in the range of 40.81-45.17 %. The specific biogas production and biogas productivity were 127.93-150.85 Lkg<sup>-1</sup>TS<sub>added</sub> and 4.81-5.71 LL<sup>-1</sup>, respectively during 6 day HRT period. Bovas (2009) reported the specific biogas production and biogas productivity of 881 Lkg<sup>-1</sup>TS<sub>added</sub> and 4.1 LL<sup>-1</sup> while treating rice mill effluent at the same HRT.

**Table 4.21 Performance parameters of experimental UAHBR at 6-day HRT**

Weeks	TS Reduction, %	Mean daily biogas production, L	Specific biogas production, L/kg TS <sub>added</sub>	Biogas productivity, LL <sup>-1</sup>
	(Weekly mean)			
1	45.17	123.73	150.85	5.71
2	40.81	104.33	127.93	4.81

The daily variation of influent and effluent pH along with the daily biogas production is depicted in Fig. 4.15. The effluent pH was as low as 5.2 at the end of 14th day showing the decline in reactor performance and inhibition of bacteria. The biogas production also seemed to deteriorate to reach minimum value of 95.7 L on 14<sup>th</sup> day.

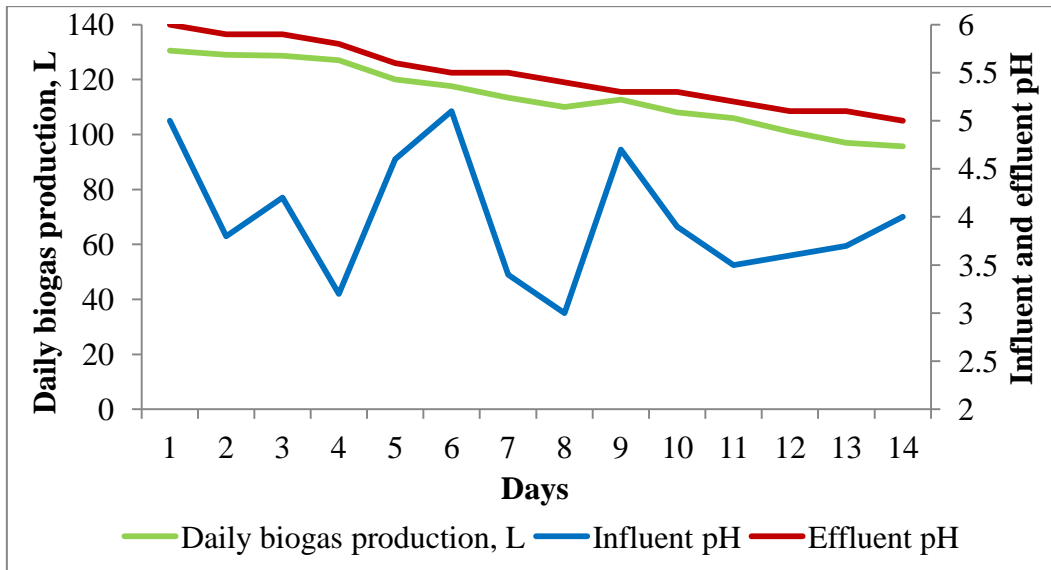

**Fig.4.15 Variation of pH and daily biogas production during 6-day HRT**

#### 4.4.8 Performance of experimental UAHBR at different HRTs

The performances of the experimental UAHBR as described by different parameters at different HRTs are discussed in this section.

The daily gas production and volumetric gas production were observed to be increasing with the shortening of HRT (Table 4.22). But the specific biogas production and biogas productivity are showing a decreasing trend with the shortening of HRTs. Similar results were also obtained by Bovas (2009), James and Kamaraj (2002) and Acharya *et. al.*(2008).

**Table 4.22 Gas production performance of the UAHBR at different HRTs**

Parameters	HRT				
	15	12	10	8	6
Daily biogas production, L	74.65	83.51	95.00	102.10	114
Volumetric biogas production, L.m <sup>-3</sup> d	74.26	642.38	730.79	785.38	876.92
Biogas productivity, LL <sup>-1</sup>	8.61	7.69	7.31	6.32	5.26
Specific biogas production, L.Kg <sup>1</sup> TS <sub>added</sub>	223.3	198.49	188.66	160.23	139.39

The reduction in organic matter indicated by TS and BOD at different HRTs are shown in Table 4.23.

**Table 4.23 TS and BOD reduction during different HRTs**

Parameters		HRT				
		15	12	10	8	6
TS, mg·L <sup>-1</sup>	Influent	38742.86	38779.22	38939.19	38931.97	37840
	Effluent	7373.83	9557.42	12432.24	18750.38	21196.5
BOD, mg·L <sup>-1</sup>	Influent	28553.33	29278.69	29062.93	29479.23	29277.93
	Effluent	2464.09	4526.17	11919.60	17886.38	19969.57
TS reduction, %		80.97	75.35	63.65	52.45	42.99
BOD reduction, %		91.56	84.54	58.98	39.33	31.79

The TS reduction was more than 80% during 15 day HRT which steadily declined to about 43% at 6 day HRT. A similar trend was also observed with BOD. A high BOD removal efficiency of the system was exhibited at 15 day HRT. The BOD reduction of 84.54% during 12-day HRT was higher than the value reported by Acharya *et al.*(2008) for distillery spent wash (73%). But the BOD removal was seen drastically diminished at 6 day HRT to a value near to 32%.

Figure 4.16 illustrates the variation of specific biogas production and volumetric biogas production in relation to TS and BOD reduction at different HRTs. It is evident that all the three major performance parameters steadily declined with shortening of HRTs. It is understood that beyond 10 day HRT, the major performance parameters start declining sharply.

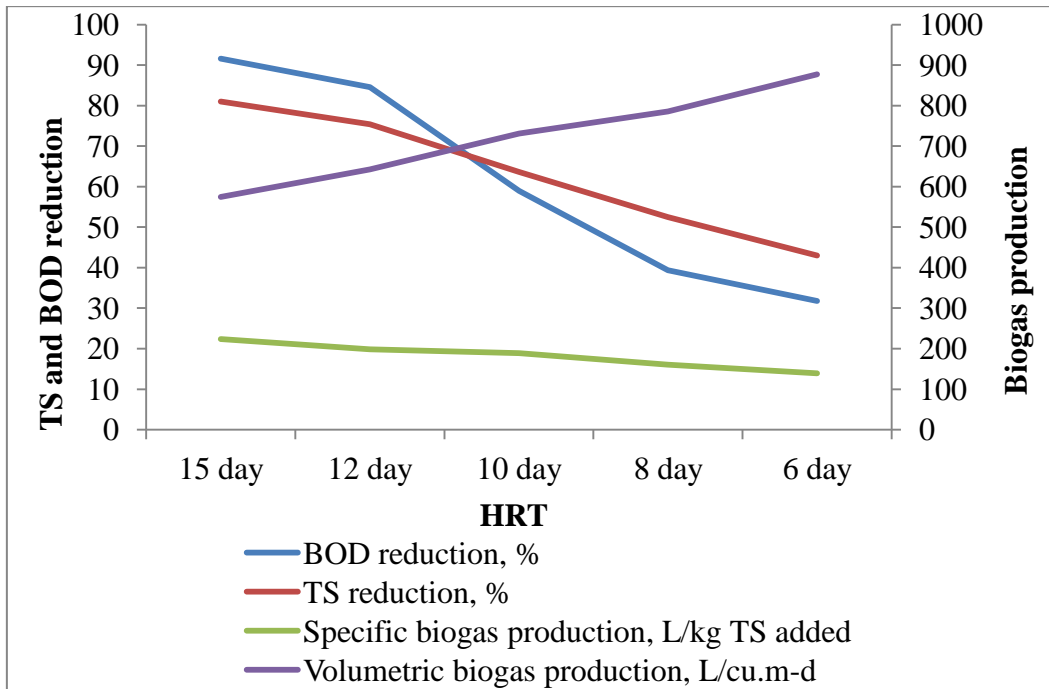

**Fig. 4.16 BOD, TS, specific biogas production and volumetric biogas production at different HRTs**

**4.4.1 Loading rates**

The organic loading rates of the reactor with respect to TS and BOD along with the respective hydraulic loading rates are depicted in Table 4.24.

**Table 4.24 Loading rates at different HRTs**

HRT	Daily feed volume, L	Hydraulic loading rate, L.m <sup>-3</sup> d	TS loading rate, kg.m <sup>-3</sup> d	BOD loading rate, kg.m <sup>-3</sup> d
15	8.66	66.62	2.56	1.90
12	10.83	83.31	3.18	2.44
10	13	100	3.87	2.92
8	16.25	125	4.86	3.69
6	21.66	166.62	6.30	4.88

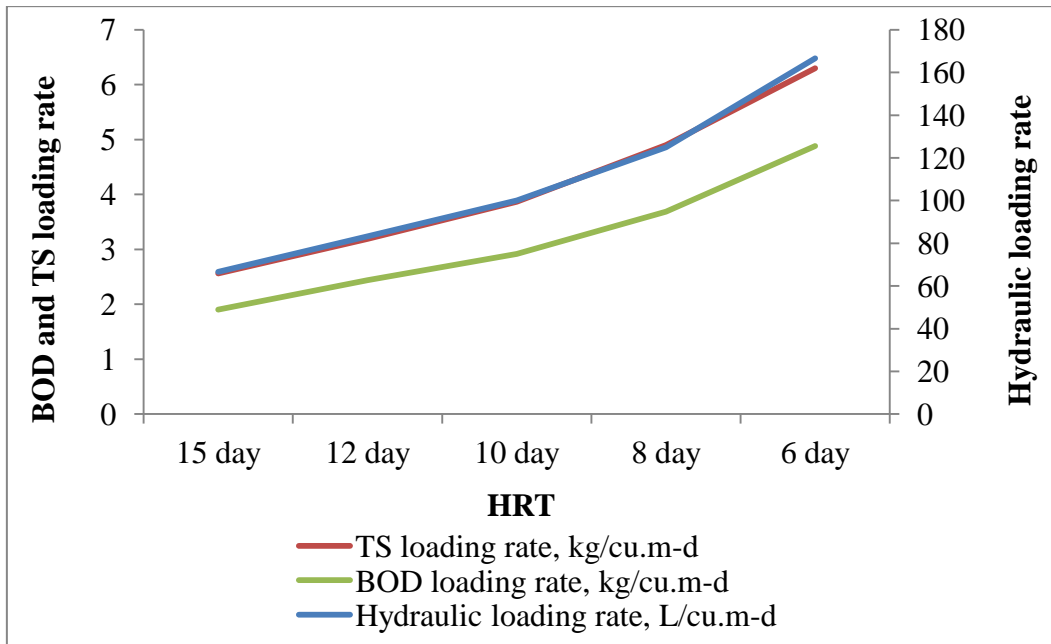

**Fig. 4.17 Variation of loading rates during different HRTs**

It can be observed from Fig. 4.17 that the change in loading rates up to 10 day HRT followed a linear trend where as from 10 to 6 day it was rather exponential. Hence the adverse effects of shortening the HRT on performance parameters were more profound during the transition from 10 day HRT to 6 day HRT.

#### **4.5 Guidelines for start-up and operation of high rate bioreactors for WCW**

It is always better to start the system with an inoculum from an existing bioreactor treating same or similar effluent. The system can be started up on a start-up HRT of 15 days with regular monitoring of pH. If pH lowers below 6 care should be taken. If the feed material is highly acidic having a pH below 4, then it should be neutralised during start-up period.

In the specific case of WCW, if maximum energy production from each litre of WCW is aimed, rather long HRTs of 15-12 day is better. The pollution load due to the organics also is reduced to significant levels. But if the interest is to produce maximum biogas with a low capacity system, even shorter HRT like 8 day also may be adopted as the volumetric gas production (per unit volume of bio reactor) is higher at shorter HRTs.

The performance obtained with experimental bioreactor was found to be inferior to full scale system. Hence if the system is properly started-up and operated with regular monitoring of pH, the full scale systems are likely to perform better than the performance observed with the experimental bioreactors, with the passage of time. Sufficient time should be provided when the loading rates are changed. Sudden change of loading rates can drastically and adversely affect bioreactor performance.

The average daily WCW discharges from edible oil mill is nearly 200 L. The total energy which can be generated from biogas produced from 200 L of WCW could be estimated as 60 MJ, considering that 1 m<sup>3</sup> of biogas with 60 to 65% methane will yield 20 MJm<sup>-3</sup> of energy. This energy can be used for thermal application.

Biogas could be burnt for thermal application with an overall efficiency of 60%. If this biogas can be used to replace the firewood presently used (average calorific value of 18 MJkg<sup>-1</sup>, thermal efficiency of 20%) we can replace 12 kg of firewood per day.

## *SUMMARY AND CONCLUSION*

## CHAPTER V

### SUMMARY AND CONCLUSION

The coconut (*cocos nucifera*) is an important crop in the tropical regions and one of the most versatile crops for edible oil production and a large number of coconut oil mills are operating in tropical countries like India. The coconut oil mills discharge considerable amount of waste coconut water (WCW) having very high values of Biochemical Oxygen Demand and Total Solids. The fermented coconut water is highly acidic with a pH lower than 4.5. Conversion of organic wastewater to methane by anaerobic digestion has significant importance in abatement of pollution and production of renewable energy. High rate bioreactors are capable of treating high volume, low strength agro-industrial wastewaters. Biomethanation of Waste Coconut Water (WCW) in high rate anaerobic bioreactors provides a means of energy generation along with pollution control. The study was aimed to assess the energy production potential of WCW through anaerobic digestion in a high rate bioreactor and to evaluate the performance of the Up-flow Anaerobic Hybrid Bio-reactor (UAHBR) for energy conversion of WCW with a view to evolve guidelines for design, installation and operation.

The preliminary biomethanation study of WCW was carried out in a lab scale floating gas holder type digester to assess the scope for biomethanation. The digester had a liquid volume of 150 L, and gas holder had a total volume of 74 L. The gas was measured using wet type gas flow meter. The evaluations of the floating gas holder digester were done by operating at different HRTs of 35, 30 and 25 days. The digester was started up at 35-day HRT after charging it with effluent from the existing bioreactor.

The mean biogas productivity was observed 1.89, 2.43 and 0.67 LL<sup>-1</sup>, respectively at HRTs of 35, 30 and 25 day. Digester showed deteriorated biogas productivity as the HRT shortened from 35 to 25 day. The performance of the digester with respect to TS reduction was in the ranges of 11.85-51.94, 23.88-40.63 and 1.38-16.16, respectively for 35, 30 and 25 day HRT.



The methane content of biogas has deteriorated from 62% to 49.33% during the transition from 35 to 25 day HRT. Digester showed deteriorating performance as the HRT was shortened from 35 to 25 days. This was a clear indication of the decrease in performance of the digester along with the reduction of HRT beyond 30 day HRT.

The full scale UAHBR installed at Edible Oil Mill had a total height of 225 cm and a diameter of 80 cm. The media comprised of broken coconut shells and was placed at the upper 60% of the reactor. The WCW feed was introduced at the bottom of the reactor by a gear pump.

The evaluation of the full scale UAHBR was done by operating the reactor initially by feeding regularly with 60 litres of WCW corresponding to a HRT of 16.7 days followed by 15-day HRT. The effluent characteristics of the reactor with respect to TS and pH were nearly steady over the period showing good stability of the system. The effluent pH was above 6.5 even though the influent pH had a low pH in the range 3.24-3.81.

The mean specific biogas production and biogas productivity ranged between 316.23 and 328.52  $\text{Lkg}^{-1}\text{TS}_{\text{added}}$  and 11.93-13.16  $\text{LL}^{-1}$ , respectively during the initial period. These parameters observed at 15 day HRT were in the ranges 290.19-308.37  $\text{Lkg}^{-1}\text{TS}_{\text{added}}$  and 11.01-12.47  $\text{LL}^{-1}$ , respectively. The performance of the reactor in terms of TS reduction was in the range of 78.75-80.24 and 79.35-81.40%, respectively, during initial period and 15-day HRT period.

Experimental UAHBR fabricated and installed at Nila Oil Mill, Kittippuarm had a total height of 203 cm and a diameter of 30.5 cm. The media (broken coconut shells) was placed at the upper 38% of the reactor. The WCW was introduced at bottom of the reactor and was gravity fed through an overhead tank.

The evaluation of the experimental UAHBR was done by operating at different HRTs of 15, 12, 10, 8 and 6 days. The daily feeding of the reactor was started on the 11<sup>th</sup> day at a start-up HRT of 15 day and was operated on that HRT

for 62 days. Reactor took 41 days to reach a near stable condition in gas production. The effluent characteristics of the reactor with respect to TS, BOD and pH were mostly steady over the period showing good stability of the reactor. The effluent pH was in the range of 6.2-6.9.

The mean biogas productivity was 8.61, 7.69, 7.31, 6.32 and 5.26  $\text{LL}^{-1}$ , respectively at HRTs of 15, 12, 10, 8 and 6 day period of operation. The reactor showed good gas production performance during the period and the maximum specific gas production was  $225.73 \text{ Lkg}^{-1}\text{TS}_{\text{added}}$  during 15-day HRT period. The highest biogas productivity observed at 15-day HRT was  $8.70 \text{ LL}^{-1}$ . The performance of the reactor with respect to TS and BOD reductions were in the range of 80.97 and 42.99%, and 91.56 and 31.79% during the HRTs of 15 and 6 day respectively. Reactor showed declining TS and BOD reductions as the HRT was shortened from 15 to 6 day. The mean effluent pH values were 6.78, 6.44, 6.33, 6.25 and 5.47 respectively, during HRTs of 15, 12, 10, 8 and 6 days. The effluent pH seemed declining as the HRT was shortened from 15 day to 6 day.

The mean hydraulic loading rates of the reactor during various HRT periods were 66.62, 83.31, 100, 125 and  $166.62 \text{ Lm}^{-3}\text{d}$  with an Organic Loading Rate (OLR) of 2.56, 3.18, 3.87, 4.89 and  $6.30 \text{ kgTSm}^{-3}\text{d}$ , respectively, for 15, 12, 10, 8 and 6-day HRTs.

It is always better to start the system with an inoculum from an existing bioreactor treating same or similar effluent. The system can be started up on a start-up HRT of 15 days with regular monitoring of pH. If pH lowers below 6 care should be taken. If the feed material is highly acidic having a pH below 4, then it should be neutralised during start-up period.

In the specific case of WCW, if maximum energy production from each litre of WCW is aimed, rather long HRTs of 15-12 is better. The pollution load due to the organics also is reduced to significant levels. But if the interest is to produce maximum biogas with a low capacity system, even shorter HRT like 8 and 6 day also may be adopted as the volumetric gas production (per unit volume of bioreactor) is higher at shorter HRTs.

The performance obtained with experimental bioreactor was found to be inferior to full scale system. Hence if the system is properly started-up and operated with regular monitoring of pH, the full scale systems are likely to perform better than the performance observed with the experimental bioreactors, with the passage of time. Sufficient time should be provided when the loading rates are changed. Sudden change of loading rates can drastically and adversely affect bioreactor performance.

## *REFERENCES*

## REFERENCES

- Acharya, B.K., Mohana, S., and Madamwar, D. 2008. Anaerobic treatment of distillery spent wash - A study on upflow anaerobic fixed film bioreactor. *Bioresource Technol.* 99: 4621-4626.
- Agricultural statistics. 2015. Department of economics and statistics Thiruvananthapuram, Kerala.
- Alonso, R.M., Garcia, M.P., and Rio, R.S. 2014. Performance of up-flow anaerobic fixed bed reactor of the treatment of sugar beet pulp lixiviation in a thermophilic range. *Bioresource Technol.* 154: 305-312.
- Alvarez, J.A., Armstrong, E., Gomez, M., and Soto, M. 2008. Anaerobic treatment of low-strength municipal wastewater by a two-stage pilot plant under psychrophilic conditions. *Bioresource Technol.* 99: 7051-7062.
- APHA. 1989. Standard methods for the examination of water and wastewater. American Public Health Association, Washington DC, USA.
- Araujo, D.J., Rocha, S.M.S., Cammarota, M.C., Xavier, A.M.F., and Cardoso, V.L. 2008. anaerobic treatment of wastewater from the household and personal products industry in a hybrid bioreactor. *Brazilian J. Chem. Eng.* 25: 443 - 451.
- Auphimaia, C., Rukruamb, W., and Chaipraserta, P. 2014. Efficacies of various inoculum sources on methane production from agro-industrial wastewaters. *Energy Procedia.* 52: 167 - 172.
- Bae, J., Shin, C., Lee, E., Kim, J., and McCarty, P.L. 2014. Anaerobic treatment of low-strength wastewater: A comparison between single and staged anaerobic fluidized bed membrane bioreactors. *Bioresource Technol.* 165: 75-80.
- Bello-Mendoza, R. and Castillo-Rivera, M. F. 1998. Start-up of an anaerobic hybrid (UASB/filter) reactor treating wastewater from a coffee processing Plant. *Anaerobe.* 4: 219-225.
- Bodkhe, S. 2008. Development of an improved anaerobic filter for municipal wastewater treatment. *Bioresource Technol.* 99: 222-226.
- Borja, R. and Banks, C.J. 1994. Treatment of palm oil mill effluent by upflow anaerobic filtration. *J. Chem. Technol. Biotechnol.* 61: 103-109.
- Borja, R. and Banks, C.J. 1994<sup>a</sup>. Anaerobic digestion of palm oil mill effluent using an up-flow anaerobic sludge blanket reactor. *Biomass and Bioenergy.* 6: 381-389.

- Borja, R., Alba, J., and Banks, C.J. 1996. Anaerobic digestion of wash waters derived from the purification of virgin olive oil using a hybrid reactor combining a filter and a sludge blanket. *Process Biochem.* 31(3): 219-224.
- Bovas, J.L. 2009. Development of High Rate Anaerobic Bioreactor for energy production from rice - Mill effluent. *M-Tech Thesis*, Department of farm power, machinery and energy, Kelappaji College of Agricultural Engineering and Technology, Tavanur.
- CDB. [www.coconutboard.gov.in](http://www.coconutboard.gov.in)
- Chen X., Romano R T., and Zhang R. 2010. Anaerobic digestion of food wastes for biogas production. *Int. J. Agric. & Biol. Eng.* 03: 61-72.
- Choi, W., Shin, C., Son, S., Ghorpade, P.A., Kim, J., and Park, J. 2013. Anaerobic treatment of palm oil mill effluent using combined high-rate anaerobic reactors. *Bioresource Technol.* 141: 138-144.
- Cordoba, P.R., Francese, A.P., and Sineriz, F. 1995. Improved performance of a hybrid design over an anaerobic filter for the treatment of dairy industry wastewater at laboratory scale. *J. Fermentation & Bioenergy.* 79: 270-212.
- Dareioti, M. A., and Kornaros M. 2014. Effect of hydraulic retention time on the anaerobic co-digestion of agro-industrial wastes in a two-stage CSTR system. *Bioresource Technol.* 167: 407-415.
- Garcia-Calderon, D., Buffiere, P., Moletta, R., and Elmaleh, S. 1998. Anaerobic digestion of wine distillery wastewater in down-flow fluidized bed. *Water Res.* 32: 3593-3600.
- Gerardi, M.H. 2003. Wastewater microbiology series: The microbiology of anaerobic digesters. *John Wiley & Sons Inc., New York.* p: 1-10.
- Ghasimi, D.S.M., Merle de Kreuk., Sung Kyu Maeng., Zandvoort, M.H., and Van Lier, J.B. 2016. High-rate thermophilic bio-methanation of the fine sieved fraction from Dutch municipal raw sewage: Cost-effective potentials for on-site energy recovery. *Appl. Energy.* 165: 569-582.
- Goncalves, M.R., Freitas, P., and Marques, I.P. 2012. Bioenergy recovery from olive mill effluent in a hybrid reactor. *Biomass and Bioenergy.* 39: 253 - 260.
- Gonzalez-Gonzalez, A., Cuadros, F., Ruiz-Celma, A., and Lopez-Rodriguez, F. 2013. Energy-environmental benefits and economic feasibility of anaerobic codigestion of Iberian pig slaughterhouse and tomato industry wastes in Extremadura (Spain). *Bioresource Technol.* 136: 109-116.

- Hanqing, Y., and Guowei, G. 1996. Biomethanation of brewery wastewater using an anaerobic upflow blanket filter. *J. Cleaner Prod.* 4: 219-223.
- James, P.S. and Kamaraj, S. 2002. Immobilised cell anaerobic bioreactors from anaerobic bioreactors for energy production from agro-industrial waste waters -An introduction. *Bioenergy News*, 6(3):10-15.
- James, P.S. and Kamaraj, S. 2003. Hybrid anaerobic reactor for energy production from Cassava starch factory effluent. *Bioenergy News*, 7(3):10-12.
- James, S.P. and Kamaraj, S. 2003<sup>a</sup>. Energy use in Cassava Processing Industry. *J. Root Crops*. 29(1): 8-19.
- James, S.P. and Kamaraj, S. 2004. Preliminary Investigation on the Use of Coconut Shells as media for Cell immobilization in Anaerobic Bioreactors. *SESI Journal*. 14(2): 35-40.
- James, S.P. and Kamaraj, S. 2009. Performance of Up-flow Anaerobic Hybrid Reactors for pollution control and energy production from cassava starch factory effluent. *J. Root Crops*. 35(1): 69-77.
- Jensen, P.D., Yap, S.D., Boyle-Gotla, A., Janoschka, J., Carney, C., Pidou, M., and Batstone, D.J. 2015. Anaerobic membrane bioreactors enable high rate treatment of slaughterhouse wastewater. *J. Biochemical Eng.* 97: 132-141.
- Kleerebezem, R., Ivalo, M., Hulshoff Pol, L.W., and Lettinga, G. 1999. High-rate treatment of terephthalate in anaerobic hybrid reactors. *Biotechnol. Prog.* 15: 347-357.
- Koupaie, E. H., Leiva, M. B., Eskicioglu, C., and Dutil, C. 2014. Mesophilic batch anaerobic co-digestion of fruit-juice industrial waste and municipal waste sludge: Process and cost-benefit analysis. *Bioresource Technol.* 152: 66-73.
- Kumar, A., Yadav, A.K., Sreekrishnan, T.R., Santosh Satya, S., and Kaushik, C.P. 2008. Treatment of low strength industrial cluster wastewater by anaerobic hybrid reactor. *Bioresource Technol.* 99: 3123-3129.
- Kundu, K., Sharma, S., and Sreekrishnan, T.R. 2012. Effect of operating temperatures on the microbial community profiles in a high cell density hybrid anaerobic bioreactor. *Bioresource Technol.* 118: 502-511.
- Kundu, K., Sharma, S., Sreekrishnan, T.R. 2013. Changes in microbial communities in a hybrid anaerobic reactor with organic loading rate and temperature. *Bioresource Technol.* 129: 538-547.

- Kurniawana, R., Kristantia, N.E., and Sukartikoa, A.C. 2015. Wastewater Treatment in Cajuput Oil Industry using Anaerobic Filtration. *Agric. & Agric. Sci. Procedia*. 3: 216-220.
- Leal, K., Chacin, E., Behling, E., Gutierrez, E., Fernandez, N., and Forster, C. F. 1998. A mesophilic digestion of brewery wastewater in an unheated anaerobic filter. *Bioresource Technol.* 65: 51-55.
- Lettinga, G., Van Velson, A.F.M., Hobma, S.W., de Zeeuw, W.J. and Klapwijk, A. 1980. Use of the Up-flow Sludge Blanket (USB) reactor concept for biological wastewater treatment. *Biotechnol. Bioengng.* 22: 669-734.
- Li, T., Bo, L., Yang, F., Zhang, S., Wu, Y., and Yang, L. 2012. Comparison of the removal of COD by a hybrid bioreactor at low and room temperature and the associated microbial characteristics. *Bioresource Technol.* 108: 28-34.
- Lin, H., Peng, W., Zhang, M., Chen, J., Hong, H., and Zhang, Y. 2013. A review on anaerobic membrane bioreactors: Applications, membrane fouling and future perspectives. *Desalination*. 314: 169-188.
- Lo, K.V., Liao, P.H., and Gao, Y.C. 1994. Anaerobic treatment of swine wastewater using hybrid UASB reactors. *Bioresource Technol.* 47: 153-157.
- Mathur, A.N. and Rathore, N.S. 1992. Biogas production management and utilization. Himanshu publishers, New Delhi.
- McHugh, S., Collins, G., and O'Flaherty, V. 2006. Long-term, high-rate anaerobic biological treatment of whey wastewaters at psychrophilic temperatures. *Bioresource Technol.* 97: 1669-1678.
- Mohan, S., and Sunny, N. 2010. Study on biomethonization of waste water from jam industries. *Bioresource Technol.* 99: 210-213.
- Najafpour, G.D., Zinatizadch, A.A.L., Mohsmed, A.R., Isa, M.H., and Nasanollahzadeh, H. 2006. High-rate anaerobic digestion of palm oil mill effluent in an up flow anaerobic sludge-fixed film bioreactor. *Process Biochem.* 41:370-379.
- Narra, M., Balasubramanian, V., Mehta, H., Dixit, G., Madamwar, D., and Shah, A.R. 2014. Performance evaluation of anaerobic hybrid reactors with different packing media for treating wastewater of mild alkali treated rice straw in ethanol fermentation process. *Bioresource Technol.* 152: 59-65.
- Nebot, E., Romero, L.I., Quiroga, J.M., and Sales, D. 1995. Effect of the feed frequency on the performance of anaerobic filters. *Anaerobe*. 1: 113-120.
- Piper, C.S. 1996. Soil and plant analysis. Inter Science publishers Inc., New York.



- Poh, P.E. and Chong, M.F. 2014. Up-flow anaerobic sludge blanket -hollow centered packed bed (UASB-HCPB) reactor for thermophilic palm oil mill effluent (POME) treatment. *Bioresource Technol.* 67:231-242.
- Rajagopal, R., Cata Saady, N. M., Torrijos, M., Thanikal, J. V., and Hung, Y. 2013. Sustainable agro-food industrial wastewater treatment using high rate anaerobic process. *Water.* 5: 292-311.
- Rao, A. G., Naidu, G.V., Prasad, K.K., Rao, N. C., Mohan, S. V., Jetty, A., and Sarma, P.N. 2005. Anaerobic treatment of wastewater with high suspended solids from a bulk drug industry using fixed film reactor. *Bioresource Technol.* 96: 87-93.
- Reyes, O., Sanchez, E., Roviroso, N., Borja, R., Cruz, M., Colmenarejo, M.F., Sena, S., and Demirer, G.N. 2003. Anaerobic treatment of real textile wastewater with a fluidized bed reactor. *Water Res.* 37:1868-1878.
- Sison B.C.J. 1997. Disposal of coconut processing waste. *Philipp. J. Coconut Stud.* 11: 39-41.
- Smith, M.E. and Bull, A.T. 1976. Studies of the utilization of coconut water waste for the production of the food yeast *saccharomyces fragilis*. *J. Appl. Bacteriol.* 41: 81-95.
- Strydom, J.P., Britz, T.J., and Mostert, J.F. 1997. Two-phase anaerobic digestion of three different dairy effluents using a hybrid bioreactor. *Water S A.* 3 (2): 151-156.
- Tewelde, S., Eyalarasan. K, Yohannes, A., Habteslasie, T., and Karthikeyan, K. (2013). Anaerobic co-digestion of cafeteria wastes and cow dung mixtures for biogas production. *Int. J. Eng. Res. & Technol.* 2: 2278-0181.
- Tripetchkul, S., Kusuwanwichid, S., Koonsrisuk, S., and Akeprathumchai, S. 2010., Utilization of wastewater originated from naturally fermented virgin coconut oil manufacturing process for bioextract production: Physico-chemical and microbial evolution. *Bioresource Technol.* 101:6345-6353.
- Ukpai , P.A., Gabriel, F. A., Peter, E., and Elekwa, C.A. 2011. Effect of pH on the volume of gas produced from cowpea, cassava peelings. *J. Phys. Sci. & Innovation*, Volume 3.
- Wahab, M.A., Habouzit, F., Bernet, N., Steyer, J., Jedidi, N., and Escudie, R. 2014. Sequential operation of a hybrid anaerobic reactor using a lignocellulosic biomass as biofilm support. *Bioresource Technol.* 172: 150-155.
- Wang, Z. and Banks, C.J. 2007. Treatment of a high-strength sulphate-rich alkaline leachate using an anaerobic filter. *Waste Manag.* 27: 359-366.

- Wang, Z., Kim, M., Nakhla, G., and Zhu, J. 2016. Anaerobic fluidized bed digestion of primary and thickened waste activated sludges. *Chem. Eng.* 284: 620-629.
- Yilmaz, T., Yuceer, A., and Basibuyuk, M. 2008. A comparison of the performance of mesophilic and thermophilic anaerobic filters treating papermill wastewater. *Bioresource Technol.* 99: 156-163.
- Young, J.C. and McCarty, P.L. 1969. The anaerobic filter for waste treatments. *J. Water Pollut. Control Fed.* 41: 160-173.

## *APPENDICES*

## Appendix I

Biogas production and productivity of floating gas holder digester at 35-day HRT

<b>35-day HRT</b>					
<b>Days</b>	<b>Biogas production, L</b>	<b>Biogas productivity, LL<sup>-1</sup></b>	<b>Days</b>	<b>Biogas production, L</b>	<b>Biogas productivity, LL<sup>-1</sup></b>
1	14.20	3.30	22	5.20	1.20
2	14.37	3.34	23	5.60	1.30
3	15.07	3.50	24	4.80	1.17
4	12.23	2.84	25	5.35	1.24
5	9.24	2.14	26	3.29	0.76
6	10.69	2.48	27	4.13	0.96
7	8.33	1.93	28	3.20	0.74
8	9.95	2.31	29	3.62	0.84
9	8.60	2.00	30	4.98	1.15
10	6.37	1.48	31	5.73	1.33
11	10.43	2.42	32	8.18	1.90
12	9.75	2.26	33	9.69	2.25
13	5.80	1.34	34	11.10	2.58
14	4.22	0.98	35	10.60	2.46
15	5.98	1.39	36	10.20	2.37
16	6.80	2.50	37	11.40	2.65
17	5.40	1.26	38	10.60	2.46
18	4.34	1.00	39	10.10	2.34
19	5.65	1.30	40	11.00	2.56
20	5.00	1.16	41	10.80	2.51
21	5.88	1.36	42	10.60	2.46

## Appendix II

Biogas production and productivity of floating gas holder digester at 30-day HRT

<b>30-day HRT</b>					
<b>Days</b>	<b>Biogas production, L</b>	<b>Biogas productivity, LL<sup>-1</sup></b>	<b>Days</b>	<b>Biogas production, L</b>	<b>Biogas productivity, LL<sup>-1</sup></b>
1	20.10	4.02	22	9.14	1.83
2	21.90	4.22	23	10.65	2.13
3	20.50	4.10	24	11.20	2.24
4	20.00	4.00	25	10.45	2.09
5	19.40	3.88	26	10.70	2.14
6	16.70	3.34	27	10.20	2.04
7	14.20	2.84	28	9.80	1.96
8	12.45	2.49	29	9.27	1.85
9	12.00	2.40	30	10.60	2.12
10	11.90	2.38	31	10.90	2.18
11	11.64	2.33	32	10.40	2.08
12	11.35	2.27	33	11.10	2.22
13	10.90	2.58	34	11.94	2.35
14	10.56	2.11	35	10.49	2.10
15	11.15	2.23	36	10.03	2.01
16	11.20	2.24	37	11.15	2.30
17	11.78	2.36	38	9.80	1.96
18	10.40	2.08	39	10.40	2.08
19	10.85	2.17	40	10.20	2.04
20	11.00	2.20	41	10.08	2.02
21	11.20	2.24	42	9.71	1.94

### Appendix III

Biogas production and productivity of floating gas holder digester at 25-day HRT

25-day HRT					
Days	Biogas production, L	Biogas productivity, LL <sup>-1</sup>	Days	Biogas production, L	Biogas productivity, LL <sup>-1</sup>
1	9.45	1.75	14	3.10	0.52
2	9.00	1.50	15	2.75	0.46
3	8.70	1.50	16	2.60	0.44
4	8.10	1.35	17	2.40	0.40
5	7.65	1.30	18	1.87	0.31
6	7.20	1.20	19	1.93	0.32
7	6.42	1.07	20	1.80	0.30
8	5.67	0.95	21	1.70	0.28
9	4.97	0.83	22	1.50	0.25
10	4.55	0.76	23	1.43	0.24
11	4.14	0.69	24	1.30	0.22
12	3.80	0.63	25	1.20	0.20
13	3.45	0.58	26	1.00	0.17

### Appendix IV

Biogas production and productivity of full scale UAHBR at 15-day HRT

15-day HRT					
Days	Biogas production, L	Biogas productivity, LL <sup>-1</sup>	Days	Biogas production, L	Biogas productivity, LL <sup>-1</sup>
1	768	11.29	15	896	13.17
2	741	10.89	16	942	13.85
3	652	9.58	17	998	14.67
4	782	11.50	18	954	14.10
5	834	12.26	19	917	13.48
6	796	11.70	20	837	12.30
7	837	12.30	21	745	10.95
8	812	11.94	22	934	13.73
9	785	11.54	23	921	13.54
10	754	11.08	24	907	13.33
11	868	12.76	25	859	12.63
12	690	10.14	26	838	12.32
13	850	12.50	27	856	12.59
14	666	9.79	28	852	12.53

## Appendix V

Biogas production and productivity of experimental UAHBR at 15-day HRT

<b>15-day HRT</b>					
<b>Days</b>	<b>Biogas production, L</b>	<b>Biogas productivity, LL<sup>-1</sup></b>	<b>Days</b>	<b>Biogas production, L</b>	<b>Biogas productivity, LL<sup>-1</sup></b>
1	31.6	3.64	21	62.0	7.16
2	41.6	4.78	22	64.3	7.41
3	39.5	4.56	23	69.0	7.97
4	39.6	4.56	24	71.8	8.28
5	40.4	4.67	25	72.4	8.35
6	43.0	4.96	26	68.2	7.87
7	47.5	5.48	27	65.2	7.52
8	49.8	5.75	28	64.5	7.49
9	48.1	5.54	29	63.0	7.27
10	51.0	5.89	30	62.6	7.22
11	56.5	6.52	31	60.4	6.97
12	58.2	6.72	32	59.8	6.90
13	60.2	6.94	33	60.0	6.93
14	63.6	7.34	34	58.5	6.76
15	60.3	6.96	35	60.2	6.95
16	63.8	7.35	36	61.0	7.04
17	58.5	6.76	37	64.0	7.39
18	61.4	7.80	38	65.8	7.59
19	69.4	8.00	39	68.5	7.90
20	60.2	6.94	40	69.6	8.04



41	73.4	8.47	52	75.4	8.69
42	71.2	8.22	53	74.9	8.63
43	68.5	7.90	54	75.1	8.66
44	77.6	8.95	55	74.2	8.55
45	70.6	8.14	56	75.5	8.71
46	72.6	8.37	57	75.0	8.65
47	71.4	8.23	58	75.2	8.67
48	71.9	8.29	59	75.4	8.69
49	75.8	8.74	60	75.5	8.71
50	74.6	8.60	61	75.6	8.73
51	75.2	8.67	62	75.4	8.70

## Appendix VI

Biogas production and productivity of experimental UAHBR at 12-day HRT

12-day HRT					
Days	Biogas production, L	Biogas productivity, LL <sup>-1</sup>	Days	Biogas production, L	Biogas productivity, LL <sup>-1</sup>
1	66.5	6.14	14	78.0	7.19
2	68.2	6.29	15	73.0	6.72
3	67.3	6.21	16	76.0	7.00
4	69.0	6.37	17	80.3	7.40
5	70.5	6.50	18	83.5	7.69
6	72.0	6.63	19	85.0	7.83
7	78.0	7.19	20	86.2	7.94
8	75.0	6.91	21	84.0	7.74
9	68.0	6.26	22	85.4	7.87
10	70.0	6.45	23	86.0	7.93
11	72.5	6.68	24	85.8	7.90
12	76.2	7.10	25	86.3	7.95
13	75.0	6.90	-	-	-

## Appendix VII

Biogas production and productivity of experimental UAHBR at 10-day HRT

10-day HRT					
Days	Biogas production, L	Biogas productivity, LL <sup>-1</sup>	Days	Biogas production, L	Biogas productivity, LL <sup>-1</sup>
1	90.80	6.98	18	99.80	7.70
2	88.50	6.80	19	97.00	7.46
3	82.20	6.32	20	93.50	7.19
4	92.00	7.07	21	92.80	7.14
5	98.00	7.53	22	95.00	7.31
6	90.00	6.92	23	94.20	7.25
7	91.80	7.06	24	91.50	7.04
8	95.80	7.36	25	93.60	7.20
9	89.50	6.88	26	92.30	7.10
10	93.20	7.17	27	92.80	7.14
11	96.50	7.42	28	91.20	7.02
12	97.00	7.46	29	90.50	6.96
13	95.60	7.35	30	90.00	6.92
14	99.50	7.65	32	89.40	6.88
15	91.30	7.02	32	91.60	7.05
16	98.70	7.60	33	92.00	7.08
17	96.00	7.38	-	-	-

### APPENDIX VIII

Biogas production and productivity of experimental UAHBR at 8-day HRT

8-day HRT					
Days	Biogas production, L	Biogas productivity, LL <sup>-1</sup>	Days	Biogas production, L	Biogas productivity, LL <sup>-1</sup>
1	99.5	6.12	15	96.0	5.91
2	102.0	6.28	16	94.6	5.82
3	108.0	7.13	17	92.4	5.69
4	109.5	6.73	18	91.1	5.61
5	106.0	6.52	19	90.0	5.54
6	103.8	6.38	20	90.5	5.57
7	100.6	6.19	21	93.0	5.72
8	99.8	6.14	22	97.0	5.97
9	99.0	6.09	23	95.6	5.88
10	101.2	6.23	24	97.2	5.98
11	103.0	6.34	25	99.5	6.12
12	99.8	6.14	26	96.6	5.94
13	98.0	6.03	27	95.4	5.87
14	99.2	6.10	28	97.3	5.99

## APPENDIX IX

Biogas production and productivity of experimental UAHBR at 6-day HRT

<b>6-day HRT</b>		
<b>Days</b>	<b>Biogas production, L</b>	<b>Biogas productivity, LL<sup>-1</sup></b>
1	130.5	6.02
2	129.0	5.95
3	128.6	5.94
4	127.0	5.86
5	120.0	5.54
6	117.6	5.42
7	113.4	5.23
8	110.0	5.07
9	112.7	5.20
10	108.0	4.98
11	105.9	4.88
12	101.0	4.66
13	97.0	4.47
14	95.7	4.41

*ABSTRACT*

**INVESTIGATIONS ON ENERGY CONVERSION OF  
WASTE COCONUT WATER THROUGH AN UP-FLOW  
ANAEROBIC HYBRID BIOREACTOR**

by

**DAYANAND KUMBAR  
(2014-18-108)**

**ABSTRACT OF THE THESIS**

**Submitted in partial fulfilment of the  
requirement for the degree of  
MASTER OF TECHNOLOGY**

**IN**

**AGRICULTURAL ENGINEERING  
(Farm Power, Machinery and Energy)**

**Faculty of Agricultural Engineering & Technology  
Kerala Agricultural University**



**DEPARTMENT OF FARM POWER, MACHINERY AND ENERGY  
KELAPPAJI COLLEGE OF AGRICULTURAL ENGINEERING AND TECHNOLOGY  
TAVANUR - 679573, MALAPPURAM  
KERALA, INDIA**

**2016**

## ABSTRACT

Many Agro-industries discharges considerable amount of wastewater to water bodies. Anaerobic digestion of organic effluents from agro-industries has a great importance in pollution abatement as well for renewable energy production. Waste coconut water (WCW) is a medium strength waste water for which high rate anaerobic treatment is an affordable technology. This technology offers simultaneous production of energy in the form of biogas along with pollution control. Conventional biogas plants are slow in operation with long Hydraulic Retention Times (HRTs) in the order of 35 to 55 days, necessitating very large digester volumes. Hence, anaerobic treatment of WCW is technically and economically feasible only through high rate bioreactors, where we can reduce the HRTs in the range of 6 to 8 days. Hence, an investigation was taken up to study the performance of a high rate bioreactor viz. Up-flow Anaerobic Hybrid Bioreactor (UAHBR) for biomethanation of WCW.

It was revealed that the WCW had a low pH along with high Bio-chemical Oxygen Demand (BOD) and Total Solids (TS). The semi-continuous digestion WCW was carried out in a lab scale floating gas holder digester. The digester was operated at different HRTs of 35, 30 and 25 day and performance evaluated. During all HRT there was a profound effect of pH over the working of the digester. The maximum daily biogas production and biogas productivity were 21.9 L and 3.5 L.L<sup>-1</sup> during 30-day HRT. The TS reduction had the maximum value of 51.94 at 35-day HRT. The performance of the digester deteriorated at 25 day HRT and the minimum reduction was only 1.38 %. The system showed signs of failure.

Existing full scale UAHBR was operated at different HRTs of 16.67 and 15 day and performance evaluated. The reactor was stable in operation throughout the period of operation and revealed high organic reduction with biogas production. The maximum specific biogas production and biogas productivity were 354.31 Lkg<sup>-1</sup>TS<sub>added</sub> and 13.50 L.L<sup>-1</sup> during 15-day HRT. The TS reduction was in the range of 79.35 and 81.40 during the period of 15-day HRT.



Experimental UAHBR was fabricated and performance evaluated at different HRTs of 15, 12, 10, 8 and 6 day. Reactor was stable in operation during 15, 12, 10, 8 and 6 day HRTs and exhibited high process efficiency characterised by good organic reduction and biogas production. The performance was slightly deteriorated with 8 and 6-day HRT.

The maximum daily biogas production and volumetric biogas production were 114 L and 877 L.m<sup>-3</sup> for 6-day HRT. The maximum specific biogas production and biogas productivity were 225.73 L.kg<sup>-1</sup>TS<sub>added</sub> and 8.7 L.L<sup>-1</sup> during 15-day HRT.