

**INVESTIGATIONS ON SOIL, CROP AND MACHINE  
PARAMETERS TOWARDS THE DEVELOPMENT OF A ROOT  
CROP HARVESTER**

**by  
BASAVARAJ**



**DEPARTMENT OF FARM MACHINERY AND POWER ENGINEERING  
KELAPPAJI COLLEGE OF AGRICULTURAL ENGINEERING AND  
TECHNOLOGY, TAVANUR – 679 573**

**KERALA, INDIA  
2020**

**INVESTIGATIONS ON SOIL, CROP AND MACHINE PARAMETERS  
TOWARDS THE DEVELOPMENT OF A ROOT CROP HARVESTER**

by

**BASAVARAJ**

**(2017 - 28 - 004)**

**THESIS**

**submitted in partial fulfilment of the requirement for the degree of**

**DOCTOR OF PHILOSOPHY  
IN  
AGRICULTURAL ENGINEERING**

**(Farm Power and Machinery)**

**Faculty of Agricultural Engineering and Technology  
Kerala Agricultural University**



**DEPARTMENT OF FARM MACHINERY AND POWER ENGINEERING**

**KELAPPAJI COLLEGE OF AGRICULTURAL ENGINEERING AND**

**TECHNOLOGY, TAVANUR – 679 573**

**KERALA, INDIA**

**2020**

### ***DEDICATION***

This thesis is dedicated to ***My Parents, Wife and Daughter*** who sacrificed much to bring me up to this level and to my lovely brothers, friends and their families for the devotion they made to make my life successful.

## **DECLARATION**

I hereby declare that this thesis entitled '**INVESTIGATIONS ON SOIL, CROP AND MACHINE PARAMETERS TOWARDS THE DEVELOPMENT OF A ROOT CROP HARVESTER**' is a bonafide record of research work done by me during the course of research and that the thesis has not previously formed the basis for the award to me of any degree, diploma, fellowship or associateship or other similar title of any other University or Society.

**BASAVARAJ**  
**(2017-28-004)**

Place: Tavanur

Date: 30.11.2020

## **CERTIFICATE**

Certified that this thesis entitled '**INVESTIGATIONS ON SOIL, CROP AND MACHINE PARAMETERS TOWARDS THE DEVELOPMENT OF A ROOT CROP HARVESTER**' is a record of research work done independently by **Er. BASAVARAJ (2017-28-004)** under my guidance and supervision and that it has not previously formed the basis for the award of any degree, diploma, fellowship or associateship to him.

Place: Tavanur  
Date: 30.11.2020

**Dr.Jayan P R.**  
Major Advisor, Advisory Committee  
Professor & Head (FPME),  
KCAET, Tavanur.

## **CERTIFICATE**

We undersigned, members of the advisory committee of **Er. BASAVARAJ (2017-28-004)**, a candidate for the degree of Doctor of Philosophy in Agricultural Engineering, majoring in Farm Power and Machinery, agree that the thesis entitled **‘INVESTIGATIONS ON SOIL, CROP AND MACHINE PARAMETERS TOWARDS THE DEVELOPMENT OF A ROOT CROP HARVESTER’** may be submitted by **Er.BASAVARAJ**, in partial fulfilment of the requirement for the degree.

**Dr.Jayan P. R.**  
**(Chaiman, Advisory Committee)**  
Professor and Head,  
Dept. of FMPE, KCAET, Tavanur.

**Dr. Shaji James P.**  
**(Member, Advisory Committee)**  
Professor (FPME),  
Agricultural Research Station,  
Mannuthy.

**Dr. Manoj Mathew**  
**(Member, Advisory Committee)**  
Professor (FPME),  
Rice Research Station  
Moncompu, Alappuzha

**Dr. Joby Bastian**  
**(Member, Advisory Committee)**  
Professor (FPME)  
Regional Agricultural Research Station,  
Kumarakam

**Er. Shivaji K. P.**  
**(Member,Advisory Committee)**  
Assistant Professor,  
Regional Agricultural Research  
Station, Ambalavayal

**Dr. Jyothi M.L.**  
**(Member,Advisory Committee)**  
Professor & ADR(Farms)  
Kerala Agricultural University,  
Vellanikkara, Thrissur

**External Examiner**



# **ACKNOWLEDGEMEN**

---

**T**

## **ACKNOWLEDGEMENT**

First of all, I offer million gratitude to **God**, the almighty who made me do this task and made every job a success for me. He was the greatest source of all resources and provision, moral or without whose grace nothing is possible.

It is my proud privilege to express my devout gratitude and indebtedness' to my chairman **Dr.Jayan P.R.**, *Professor and Head (FMPE), KCAET, Tavanur* for his **thoughtful guidance, constant fomenting, punctilious and impeccable advices throughout the course of present study, which inspired me to carry out the research work in time.** *It is a matter of pleasure to glance back and recall the path one traversed during the days of hard work. It is still great at this juncture to recall all the faces and spirits in the form of teachers, friends, near and dear ones. I would consider this work nothing more than incomplete without attending to task of acknowledging the overwhelming help I received during this endeavor of mine.*

*It is my pleasure to pay tribute to **Dr.Sathian K.K.**, Prof. &Dean (Ag. Engg.), Kelappaji College of Agricultural Engineering and Technology, Tavanur, for his advice and guidance rendered during this study.*

*I avail this opportunity to express my sincere thanks to my advisory committee members **Dr.Shaji James P.**, Professor, Agricultural Research Station, Mannuthy, **Dr. Manoj Mathew**, Professor (FPM) RRS, Mancompu, **Dr. Joby Bastian**, Professor (FPM), RARS, Kumarakam, **Er. Shivaji K.P.**, Assistant Professor, RARS, Ambalavayal, **Dr. Jyothi M.L.** Professor & ADR, (Farms), KAU, Vellanikkara.*

*I place my special thanks to **Er. Sindhu Bhaskar**, Assistant Professor and **Er. Suma Nair**, Assistant Professor, Department of Farm Machinery and Power Engineering, KCAET, Tavanur. **Dr. Suresh Kumar, P.K.**, Professor, Dept. of Agrl. Engg.CoH, Vellanikkara, **Er.Sanchu Sukumaran**, Asst. Professor, KCAET, Tavanur and **Dr.Prince M. V.**, Prof. & Head, Dept. of P&FE, KCAET, Tavanur for their*



*valuable counsel, note-worthy guidance and cordial co-operation during my research programme.*

*I express my sincere and well devoted thanks to **Er. Younus A**, Asst. Professor(Contract), Dept. FMPE for his valuable suggestions, helpful advice and helped to carry out the research outcomes and its interpretations.*

*I offer my sincere and well devoted thanks to **Dr.Parasappa Kanannavar**, Assoc. Professor, **Dr.Anuraj and Dr.S.R Desai**, Professor, UAS, Darwad, **Dr. Ravindra Yaligar**, Consultant, ICRSAT, Hyderabad, **Er. Rudragouda Chillur**, and **Er. Mallappa Madolli**, UAS, Bangalore, for their kind guidance and great support.*

*I place my special thanks to **Dr.P.M.Salimat**, Ex-Vice Chancellor, UAS, Raichur for his kind guidance and great support.*

*I extend my earnest thanks towards **Er. Avish A.C., Er. Shamin M.K., Er. Princy U.**, Assistant Professors (contract) for their immense helps and deemed support to complete the research successfully.*

*I place my special thanks to **Gomadhi Engineering Service, Kunnathur, Tirupur district**, Tamilnadu for their kind help and great support for fabrication of the unit.*

*I also feel happy to express my heartfelt thanks to my nearest and dearest friends **Er. Venkatarreddy H.K., Er. Chandrashekar, Er. MD Pasha, Er. Chethan B.J.**, for their boundless help and caring me in every step of my studies and research work, with them support.*

*I would like to place my special thanks to my close friends **Er. Shrinivas D., Er. Prasanna Gudi, Er. Vinayak., Dr.Rahul Patil, Er.Saiprakash Patil, Er. Manasa M., and all my 23<sup>rd</sup> CAE batchmates** for their sincere help and support during my study.*

*I also wish to thank our senior friend **Dr.Dipak S. Khatawkar**, SRF, Dept. FMPE and **Dr.Sankalpa**, KAU, Thrissur for their kind support and guidance.*

*I also wish to thank our junior friend **Er. Amal, Er. Nandu Lal, Er. Ambrutha, Er. Arya KT, Er. Favazil, Er. Shrinivas, Er. Kalyan Er.Sai Mohan, Er. Babu and Er. Suraja, A.R** for their kind support and guidance.*

*My completion of this project could not have been accomplished without the support of my classmates especially, **Er.Pritty and Er. Anjaly C Sunny** for their suggestion and invaluable help during my study.*

*I would like to thank my juniors **Bandi Nageshwar and Prasang Rank** for their invaluable help during soil testing.*

*I express my thanks to all the faculty **members of library, KCAET, Tavanur**, for their ever willing help and cooperation. I express my sincere thanks and gratitude to **Kelappaji College of Agricultural Engineering & Technology** for giving me an opportunity to undergo my P.G studies and **Kerala Agricultural University** for having proffered me a chance to study in this institution.*

*Words are inadequate to express my heartfelt gratitude to my beloved parents **Sri. Amaregoudapatil. And Smt. Devikamma** for their everlasting love and affection, help, support, incessant motivation and constant encouragement throughout my life.*

*Words are inadequate to express my heartfelt gratitude to my beloved brothers **Sri. Mallikarjun Patil, Sri.Veeranagouda Patil and Sri.Shivarajpatil** and my sister **Smt. Umadevi**, for their everlasting love and affection, help, support, incessant motivation and constant encouragement throughout my life.*

*I am greatly indebted to my father in law **Sri. Hanumareddi Budihal** and mother in law **Smt. Gangu Budihal, Er. Anand Budihal and Pavitra Budihal, Sri. Chandrashekar**, for their everlasting love and affection, help, support, valuable advice, incessant motivation and constant encouragement throughout my life.*

*I have been highly fortunate and lucky to express my heartfelt respect to my dearest sisters and my relatives for their kind blessings and well wishes showed on me.*

*One last word; since it is practically impossible to list all contributions to my work, it seems proper to issue a blanket of thanks for those who helped me directly or indirectly during the course of my study.*

**BASAVARAJ**

## CONTENTS

Chapter No.	Title	Page No.
	LIST OF TABLES	i-iii
	LIST OF FIGURES	iv-vi
	LIST OF PLATES	vii
	LIST OF APPENDICES	viii
	SYMBOLS AND ABBREVIATIONS	ix-xi
<b>I</b>	INTRODUCTION	1-5
<b>II</b>	REVIEW OF LITERATURE	6-27
<b>III</b>	MATERIALS AND METHODS	28-76
<b>IV</b>	RESULTS AND DISCUSSION	77-154
<b>V</b>	SUMMARY AND CONCLUSION	155-161
	REFERENCES	162-172
	APPENDICES	173-192
	ABSTRACT	193-194

## LIST OF TABLES

Table No.	Title	Page No.
1.1	Area, production and productivity of root crops in Kerala (2017-18)	3
1.2	Area, production and productivity of root crops in India (2018-19)	3
3.1	Research works on root crop harvesters with different digging blades	42
3.2	Factors selected for the experiment	79
4.1	Properties of soil parameters at the time of harvesting of coleus, ginger and turmeric	80
4.2	Specifications of the root crop harvester	90
4.3	Analysis of variance on draft for harvesting coleus	92
4.4	Analysis of variance on digging efficiency for coleus	96
4.5	Analysis of variance on per cent damage of harvesting coleus	100
4.6	Analysis of variance on fuel consumption of tractor for coleus	103
4.7	Analysis of variance on conveying efficiency for coleus	106
4.8	Analysis of variance on soil separation index for coleus	107
4.9	Numerical optimization constraints on digging unit	109
4.10	Best optimal solutions of digging unit for harvesting coleus	110
4.11	Optimization constraints of soil separator unit for coleus	111
4.12	Best optimal solutions of the soil separator unit for coleus	111

---

4.13	Analysis of variance on draft for harvesting ginger	113
4.14	Analysis of variance on digging efficiency of ginger	117
4.15	Analysis of variance on per cent damage of ginger	121
4.16	Analysis of variance on fuel consumption of tractor for ginger	124
4.17	Analysis of variance on conveying efficiency in ginger	127
4.18	Analysis of variance on soil separation index in ginger	128
4.19	Numerical optimization constraints on digging unit of ginger	130
4.20	Best optimal solutions of digging unit for harvesting ginger	130
4.21	Optimization constraints for soil separator unit for ginger	132
4.22	Best optimal solutions of soil separator unit for harvesting ginger	132
4.23	Analysis of variance on draft for harvesting turmeric	134
4.24	Analysis of variance on digging efficiency for turmeric	138
4.25	Analysis of variance on per cent of damage of turmeric	141
4.26	Analysis of variance on fuel consumption for harvesting turmeric	145
4.27	Analysis of variance on conveying efficiency in turmeric	148
4.28	Analysis of variance on soil separation index in turmeric	149
4.29	Numerical optimization constraints on digging unit	151

---

---

4.30	Best optimal solutions of digging unit for turmeric	151
4.31	Optimization constraints for soil separator unit	152
4.32	Best optimal solutions of soil separator unit for turmeric	152
4.33	Performance evaluation of root crop harvester	154

---

## LIST OF FIGURES

Fig. No.	Title	Page No.
3.1	Raised beds for coleus	34
3.2	Raised beds for ginger and turmeric	34
3.3	Soil working tool	51
3.4	Spring for finger assembly	55
3.5	Orthographic view of crank rocker mechanism	57
3.6	Isometric view of crank rocker mechanism	58
3.7	Crank rocker mechanism without constraints	59
3.8	Crank rocker mechanism with constraints	59
3.9	Displacement diagram of the model w.r.t crank angle	60
3.10	Velocity diagram of the model w.r.t crank angles for 200, 220 and 240 rpm	60
3.11	Acceleration diagram of the model w.r.t crank angles at 200, 220 and 240 rpm	60
3.12	Isometric view of root crop harvester	62
3.13	Orthographic view of root crop harvester	63
3.14	Types of digging unit	65
4.1	Draft requirement for harvesting coleus at 1.5 km h <sup>-1</sup>	93
4.2	Draft requirement for harvesting coleus at 2.0 km h <sup>-1</sup>	93
4.3	Draft requirement for harvesting coleus at 2.5 km h <sup>-1</sup>	94
4.4	Digging efficiency for harvesting coleus at 1.5 km h <sup>-1</sup>	97
4.5	Digging efficiency for harvesting coleus at 2.0 km h <sup>-1</sup>	97

---

4.6	Digging efficiency for harvesting coleus at 2.5 km h <sup>-1</sup>	98
4.7	Per cent damage of coleus at 1.5 km h <sup>-1</sup>	100
4.8	Per cent damage of coleus at 2.0 km h <sup>-1</sup>	101
4.9	Per cent damage of coleus at 2.5 km h <sup>-1</sup>	101
4.10	Fuel consumption for harvesting coleus at 1.5 km h <sup>-1</sup>	104
4.11	Fuel consumption for harvesting coleus at 2.0 km h <sup>-1</sup>	104
4.12	Fuel consumption for harvesting coleus at 2.5 km h <sup>-1</sup>	105
4.13	The conveying efficiency for coleus	107
4.14	The soil separation index for coleus	108
4.15	Desirability index for digging unit for coleus	109
4.16	Desirability index of soil separator unit for coleus	111
4.17	The draft requirement for harvesting ginger at 1.5 km h <sup>-1</sup>	114
4.18	The draft requirement for harvesting ginger at 2.0 km h <sup>-1</sup>	114
4.19	The draft requirement for harvesting ginger at 2.5 km h <sup>-1</sup>	115
4.20	Digging efficiency for harvesting ginger at 1.5 km h <sup>-1</sup>	118
4.21	Digging efficiency for harvesting ginger at 2.0 km h <sup>-1</sup>	118
4.22	Digging efficiency for harvesting ginger at 2.5 km h <sup>-1</sup>	119
4.23	Per cent damage of ginger at 1.5 km h <sup>-1</sup>	121
4.24	Per cent damage of ginger at 2.0 km h <sup>-1</sup>	122
4.25	Per cent damage of ginger at 2.5 km h <sup>-1</sup>	122
4.26	Fuel consumption for harvesting ginger at 1.5 km h <sup>-1</sup>	125
4.27	Fuel consumption for harvesting ginger at 2.0 km h <sup>-1</sup>	125

---



---

4.28	Fuel consumption for harvesting ginger at 2.5 km h <sup>-1</sup>	126
4.29	The conveying efficiency for ginger	128
4.30	The soil separation index for ginger	129
4.31	Desirability index for optimized digging unit for ginger	130
4.32	Desirability index for optimized soil separator unit for ginger	131
4.33	Draft requirement for harvesting turmeric at 1.5 km h <sup>-1</sup>	134
4.34	Draft requirement for harvesting turmeric at 2.0 km h <sup>-1</sup>	135
4.35	Draft requirement for harvesting turmeric at 2.5 km h <sup>-1</sup>	135
4.36	Digging efficiency for harvesting turmeric at 1.5 km h <sup>-1</sup>	138
4.37	Digging efficiency for harvesting turmeric at 2.0 km h <sup>-1</sup>	139
4.38	Digging efficiency for harvesting turmeric at 2.5 km h <sup>-1</sup>	139
4.39	Per cent damage of turmeric at 1.5 km h <sup>-1</sup>	142
4.40	Per cent damage of turmeric at 2.0 km h <sup>-1</sup>	142
4.41	Per cent damage of turmeric at 2.5 km h <sup>-1</sup>	143
4.42	Fuel consumption for harvesting turmeric at 1.5 km h <sup>-1</sup>	145
4.43	Fuel consumption for harvesting turmeric at 2.0 km h <sup>-1</sup>	146
4.44	Fuel consumption for harvesting turmeric at 2.5 km h <sup>-1</sup>	146
4.45	The conveying efficiency for turmeric	148
4.46	The soil separation index for turmeric	149
4.47	Desirability index for optimized digging unit for turmeric	150
4.48	Desirability index of soil separator unit for turmeric	152

---

**LIST OF PLATES**

<b>Plate No.</b>	<b>Title</b>	<b>Page No.</b>
3.1	Width of the raised bed	35
3.2	Height of bed	35
3.3	Soil tuber/rhizome composite	36
3.4	Types of digging unit	66
3.5	Prototype of the root crop harvester	67
3.6	Prototype root crop harvester attached with tractor	68
3.7	View of root crop harvester in field	69
3.8	Measurement of draft	70

## LIST OF APPENDICES

Appendices No.	Title	Page No.
I	Biometric observations of tuber/rhizome in the field at the time of harvesting	173
II	Physical properties of coleus	174
III	Physical properties of ginger	175
IV	Physical properties of turmeric	176
V	Coefficient of friction of tuber/rhizome	177
VI	Angle of repose and firmness of tuber/rhizome	177
VII	Draft, Digging Efficiency, Per Cent Damage and Fuel Consumption for Coleus	178-179
VIII	Draft, Digging efficiency, Per cent Damage and Fuel consumption for Ginger	180-181
IX	Draft, Digging efficiency, Per cent Damage and Fuel consumption for Turmeric	182-183
X	Conveying efficiency and soil separation index of the root crop harvester on coleus	184
XI	Conveying efficiency and soil separation index of the root crop harvester on ginger	185
XII	Conveying efficiency and soil separation index of the root crop harvester on turmeric	186
XIII	Mean and Co-efficient of variation for the operational parameters of the root crop harvester for coleus, ginger and turmeric	187
XIV	Economic evaluation of developed root crop harvester	188-192

## SYMBOLS AND ABBREVIATIONS

Symbols	:	Abbreviations
<	:	Less than
>	:	Greater than
%	:	Per cent
±	:	Plus or minus
×	:	Multiplication
÷	:	Division
≤	:	Less than or equal to
≥	:	Greater than or equal to
deg.	:	Degree (°)
°C	:	Degree centigrade
ASAE	:	American Society of Agricultural Engineers
CI	:	Cone index
Cm	:	Centimeter
cm <sup>2</sup>	:	Square centimeter
cm <sup>3</sup>	:	Cubic centimeter
cc rev <sup>-1</sup>	:	Cubic centimeter per revolution
d.b	:	dry basis
<i>et al.</i>	:	and others
etc.	:	et cetera
Fig.	:	Figure
G	:	Gram
g cm <sup>-3</sup>	:	Gram per cubic centimeter
GI	:	Galvanized iron
H	:	Height
Ha	:	Hectare
Hp	:	Horse power
H	:	Hour
ha h <sup>-1</sup>	:	Hectare per hour
IS	:	Indian standards

---

KAU	:	Kerala Agricultural University
KCAET	:	Kelappaji College of Agricultural Engineering and Technology
Kg	:	Kilogram
kg cm	:	Kilogram centimeter
kg cm <sup>-2</sup>	:	Kilogram per square centimeter
kg ha <sup>-1</sup>	:	Kilogram per hectare
kg m	:	Kilogram meter
kg m <sup>-3</sup>	:	Kilogram per cubic meter
Kgf	:	Kilogram force
Km <sup>2</sup>	:	Kilometer square
km h <sup>-1</sup>	:	Kilometer per hour
kN	:	Kilo newton
kNm <sup>2</sup>	:	Kilo newton per meter square
Kw	:	Kilo watt
L	:	Length
/h <sup>-1</sup>	:	Litre per hour
M	:	Meter
m min <sup>-1</sup>	:	Meter per minute
m s <sup>-1</sup>	:	meters per second
m <sup>2</sup>	:	Square meter
m <sup>3</sup>	:	Cubic meter
Mm	:	Millimeter
mm <sup>2</sup>	:	Square millimeter
MS	:	Mild steel
N	:	Newton
N cm <sup>-2</sup>	:	Newton per square centimeter
N m <sup>-1</sup>	:	Newton per meter
Nm	:	Newton meter
P.T.O	:	Power Take Off
pH	:	Potential of hydrogen

---

---

Rpm	:	Revolutions per minute
rad s <sup>-1</sup>	:	Radian per second
Sl. No.	:	Serial Number
T	:	Tons
USDA	:	United States Department of Agriculture
<i>viz.</i>	:	Namely
W	:	Width
Wb	:	Wet basis
w.r.t	:	With Respect To
$\alpha$	:	Alpha
$\theta$	:	Theta
$\mu$	:	mue
$\pi$	:	Pi
$\rho$	:	Rho
$\eta$	:	Efficiency

---

---

# INTRODUCTION

## CHAPTER I

### INTRODUCTION

India is world's largest producer of vegetables after China and contributed about 34 per cent of world vegetable production in the year 2016-17. In vegetables, potato, ginger, turmeric, yam, sweet potato, carrot and coleus are some of the common root crops. The area and production of coleus, ginger and turmeric in India during 2018-19 was 4.23 Lakh hectares and 2888 MT respectively (Anon., 2019). Tubers contributed 1.92 per cent area of food crops during the year 2017-18. Elephant foot yam, colocasia, yam, sweet potato, coleus etc. are included in the category of tubers.

In this era of diversification of agriculture, farmers are shifting from traditional subsistence agriculture to commercial intensive agriculture. In India, 64.80 per cent of farmers are marginal, with an average land holding of 1.23 ha (Anon. 2010) as compared to the world's average land holding of 5.5 ha.

'Coleus' commonly known as 'Chinese potato' is a good tuber crop recently getting wide acceptance among the farmers of Kerala. In India, coleus is grown in Andhra Pradesh, Karnataka, Madhya Pradesh, Gujarat, Assam, Kerala and Tamil Nadu . In Kerala, the coleus is minor tuber crop cultivated in an area of about 930.51 ha having a production of 18610 tonnes, while ginger and turmeric are the major rhizome crops cultivated in 3275 ha and 2483 ha having a production of 15124 and 6694 tonnes, respectively (Anon., 2019).

Coleus, ginger and turmeric thrive well in tropical land sub-tropical regions with well drained medium fertile soil. Ideal season of cultivation of coleus in Kerala is from July to December while it is from April to December for ginger and turmeric. Three major varieties of coleus grown in the state are Nidhi, Suphala and SreeDhara and the ginger varieties are Athira, Karthika, IISR Varada and Himachal and turmeric varieties are Alleppy, Suguna, IISR Kedaram and Varna etc. (KAU, 2016). Now a days these crops are mostly grown in raised beds in garden lands and wet lands of Kerala. The recommended bed sizes for coleus is width of 90 cm and height of 15-20



cm while that for ginger and turmeric is 1.0 to 1.2 m width and height 25 cm. The spacing between beds is 40 cm. (KAU, 2016)

The coleus belongs to the *Lamiaceae* family often called the mint family. Coleus is one of the minor tuber crops grown for its edible tubers, which have special, flavour and taste and used as vegetable. It is also called as 'Chinese potato', in English. In Malayalam it is known as 'koorkka'. A well-drained medium fertile soil is suitable for its cultivation. It is grown in most of the homestead gardens of Thrissur, Palakkad and Malappuram districts. It grows well in warm humid climate and in drained medium fertile soils. Coleus is growing in paddy fields as well as in garden lands. Tender shoot tips collected from the nursery are planted in the main field on raised beds at a spacing of 30 x 15 cm at a depth of 5 to 10 cm. Harvesting is done when haulms dry up, *i.e.*, 4 to 6 months after planting (Younus, 2016).

Ginger (*Zingiber officinale*) is one of the very important cash crop and principal spice of India and abroad (Bartley and Jacobs, 2000). It is a perennial plant that grows to a height of 600 to 900 mm from underground rhizomes in tropical and subtropical climate (Mendi *et al.*, 2009). Ginger can be grown in both rain fed and irrigated conditions. For successful cultivation of this root crop, a moderate rainfall at sowing period till the rhizomes sprout, fairly heavy and well distributed showers during growing period and dry weather for about a month before harvesting are necessary. Ginger thrives best in well drained soils like sandy loam, clay loam or lateritic loam. Ginger is one of the spices that assist large number of farmers in the states of Kerala, Karnataka, Arunachal Pradesh, Orissa, West Bengal, Sikkim and Madhya Pradesh (Karthick *et al.*, 2015). However, Kerala, Karnataka, Orissa, Assam, Meghalaya, Arunachal Pradesh and Gujarat together contribute 65.00 per cent of the country's total production. Ginger accomplishes full maturity in 210-240 days after planting. Harvesting of ginger for vegetable purpose starts after 180 days based on the demand. However, for making dry ginger, the matured rhizomes are harvested at full maturity *i.e.* when the leaves turning yellow and start drying. Usually, In India the crop is harvested between January and March months.

Turmeric is a tropical herb and may be grown on various forms of soil under irrigated and rainfed conditions. Loamy soils having precise drainage are ideal for the crop. It is a shade tolerant crop with shallow roots appropriate for intercropping. India is the world's largest producer of turmeric (*Curcuma longa*) known as 'Indian Saffron' and considered the best due to its high curcumin content. It is used in diversified industries as condiment, a flavouring and colouring agent and principal ingredient in curry powder apart from pharmaceuticals and cosmetic industry. The country consumes 80 per cent of turmeric production and the rest is exported. Turmeric is grown in 25 States of India with Kerala, Andhra Pradesh, Tamil Nadu, Karnataka and Orissa being the leading producers. Other main producers of turmeric are Gujarat, West Bengal, Assam, Meghalaya, and Maharashtra. India has nearly 246 thousand ha under turmeric cultivation with a total production of 1389.0 thousand million tonnes during the year 2018-19. During 2017-18, The area under turmeric has increased by 5.58 per cent compared to 2016-17. A highest turmeric cultivation of 23.58 per cent was recorded in Palakkad district during 2017-18 (Anon, 2019). The Area, production and productivity of coleus, ginger and turmeric in Kerala (2017-18) and India (2018-19) are shown in Table.1.1 and 1.2.

**Table 1.1 Area, production and productivity of root crops in Kerala (2017-18)**

<b>Root crops</b>	<b>Area (ha)</b>	<b>Production (tones)</b>	<b>Productivity (MT ha<sup>-1</sup>)</b>
Coleus	1271	25420	20.00
Ginger	4370	86270	19.74
Turmeric	2780	6506	3.17

*Source:* Farm guide, 2019 (Farm Information Bureau, Govt. of Kerala)

**1.2 Area, production and productivity of root crops in India (2018-19)**

<b>Root crops</b>	<b>Area (ha)</b>	<b>Production (MT)</b>	<b>Productivity (MT ha<sup>-1</sup>)</b>
Coleus	1271	25420	20.00
Ginger	175000	1451000	8.3
Turmeric	246000	1389000	5.6

*Source:* Department of Agriculture, Cooperation and Farmers (Horticulture Statistics Division, Agricultural Statistics at a glance, 2019).

### **Indian Scenario of coleus, ginger and turmeric**

Cultivation of ginger and turmeric play an important role as a spice. There was considerable increase in the area from 53.60 and 124.00 thousand ha in 1989-90 to 175.00 and 246.00 thousand ha in 2018-19 for ginger and turmeric, respectively. However, the production has increased from 156.1 and 459.5 thousand tonnes in 1989-90 to 1451 and 1389.00 thousand tonnes in 2018-19 for ginger and turmeric, respectively.

In the root crops production *viz.* tubers and rhizomes cultivation, harvesting is one of the most critical operation in which the tubers/rhizomes are to be dig out from soil without any bruise. They need to be manually separated from the soil and collected from the field. In the conventional method of harvesting, these are dug out manually with the help of hand tools *i.e.*, special fork, spade and pick axe. Bullock drawn, tractor and power tiller drawn implement are commonly used to dig out these tubers/rhizomes. It was found that there is a noticeable damage to the tubers/rhizomes during harvesting. However, due to non-availability of suitable devices, Manual digging operation is carried out. It is not only laborious and costly but also causes 10-15 per cent damage to tuber/rhizome as these are to be dig out the clump and the possibility of bruise the tuber/rhizome is more (Jayashree and Visvanathan, 2011). It is reported that about 150-185 man h per hectare is required for harvesting of sweet potato (Kepner *et al.*, 2005). Thus, this method of uprooting is highly labour intensive, tedious and time consuming. The post-harvest studies of ginger indicated that, approximately 70 per cent of the rhizomes are spoiled and wasted due to the storage rots caused by difficult harvesting and handling practices resulting in damage of skin and flesh of the rhizomes (Rattan *et al.*, 1988). Bruising and damaging the tubers/rhizomes indirectly affect its quality and market price. Also there is difficulty often to get required labour for harvesting tubers in time. Hence there is a need to develop suitable mechanical harvesting machines for the root crops. It ensures timeliness of operation, reduces cost of harvesting, crop damage and drudgery.

Development of a suitable attachment to the conventional farm tractors to harvest the tuber/rhizome appear to be the most appropriate mechanical harvesting technology to satisfy the requirements in harvesting tubers/rhizomes by the farmers.

This will help to achieve increases yield with minimum field losses, damage and cost. An appropriate mechanism attachable to a tractor P.T.O power with digging and soil separator units will serve the purpose. With these in view, an investigation to develop a suitable tractor operated root crop harvester to dig out the tubers/rhizomes was taken up with the following objectives.

1. To study the soil and crop parameters to design a root crop harvester
2. To develop a tractor drawn root crop harvester
3. To test and optimize the machine parameters of the root crop harvester
4. To workout economics of the developed root crop harvester

---

## **REVIEW OF LITERATURE**

## CHAPTER II

### REVIEW OF LITERATURE

The scientific information on root crops in relation to soil, crop and machine parameters have been outlined in this chapter. The reviews on operational parameters affecting the performance on digging, handling, collecting and separating units are briefed. The experimentation procedure and concerned design values were fixed after reviewing the information pertaining to the digging and separator units of the root crop harvester. The most recently designed on the root crop harvesting systems and the methods adopted for its performance evaluation have been reviewed to meet the required standards experimental trials.

A detailed review of the information pertinent to the above aspects of the problem under the study is grouped under the subsequent headings.

- i. Soil parameters
- ii. Crop parameters
- iii. Development and testing of root crop harvesters

#### 2.1 SOIL PARAMETERS

The performance of a soil working tool was mostly affected by soil moisture content and bulk density. The amount of power required to draw a soil interacting tool is completely dependent on the bulk density of soil.

Yumnam and Pratap (1991) recommended the optimum values of rake angle between 10 and 30 deg. for minimum energy requirement for root crops, since the blade rake angle affects the energy consumption in cutting and digging the soil.

Wulfsohn *et al.* (1996) studied the shear strength of the soil different soil based models and concluded that soil and water characteristics determine the soil behavior. It has been predicted that for a tool width and depth ratio of 5, performing at 15 cm depth and 40 deg. rake angle, the draft force of the device increased at 15 per cent moisture content to 2 kN, whereas the draft increased to 5.5 kN when the soil moisture was decreased to 13 per cent.

Duraisamy (1997) observed that the decreased in soil moisture content increased the draft requirement for mechanical harvesting of groundnut and suggested 13.5 per cent as optimal soil moisture for loamy sand and sandy loam soils to harvest groundnut.

As the working width of the tool increases, the amount of draft required also increases (same applies for depth and rake angle). Change in rake angle doesn't affect the cross-section of soil being disturbed but controls the draft and soil cutting efficiency (Saleh *et al.*, 1997).

Ferguson *et al.* (1998) studied the wear of shares of the cultivator with commercial sweeps of 5 mm thick and 150 mm wide at the operating speed of 12 km h<sup>-1</sup> for the cutting depths of 75 mm and 55 mm. The tests were carried out for 2 to 8 km h<sup>-1</sup> of travel speed in the two different types of soil containing 0 and 9 per cent gravel. The life of the share found out was 168 km in the soil containing 0 per cent gravel and 9 km in the soil containing 9 per cent gravel.

Agodzo and Adama (2003) measured the cone index of a soil and had been shown to be affected by its water content and bulk density and was usually measured in kilo Pascal (kPa). According to USDA (1990), penetration resistance (Cone Index) depends on the soil water content, soil, the larger the resistance to penetration. Therefore, the water content of the soil should be noted when taking a measurement of cone index.

Ramachandran and Jesudas (2017) measured the cone index of soil in wet land using digital cone penetrometer. Penetration resistance of the soil were measured at 4 different places under wet land at begin of puddling operation by tractor. The data of cone index values decreased with the increased in moisture content of the soil. The cone penetrometer with a cone base area of 7.80 cm<sup>2</sup> was used to measure the strength of soil. The penetration resistance in the upper layer of the soil varied from 13.63 to 35.00kPa in CWL and 6.30 to 40.57 kPa in CPBS. In case of ADT and BSR sites, the soil strength profile was determined to be uniform and average penetration resistance in 0 to 30 cm depth varied from 67.66 to 166.73 kPa and 75.91 to 169.85 kPa respectively.

## 2.2 CROP PARAMETERS

The performance of any agricultural machines is affected by the shape and size of the agricultural material being handled. The operational efficiency of a harvester is said to be a function of the orientation of the feed being loaded. Knowledge of the physical properties of a material will go a long way to enhance efficient design of machines and systems for the harvesting of such materials.

Govindarajan (1980) indicated that in turmeric, the vegetative growth characteristics which included number of plant tillers, plant height and size of leaves etc. were found to related with yield.

Sivaraman (1992) reported number of tillers, number of mother rhizomes and number of primary and secondary fingers per hill as major yield attributes of turmeric. The information suggested that the most important single impact on the quality of dried turmeric is the intrinsic characteristics of the cultivars grown, and that the second most important factor is probably the stage of maturity of the rhizome at harvest.

Chattopadhyay *et al.* (1993) stated that, the turmeric yield decreases with the increase in spacing and 20×30 cm spacing was found out as optimum and gave significantly higher yield of 25.72 t ha<sup>-1</sup>.

Bobobee *et al.*(1994) studied the impediments of soil attributes, nature and tubers size, depth and width of cluster and bond between tubers and the soil towards the development of a mechanical harvester for cassava. They observed that the damage of tubers deteriorated rapidly after 3 days of harvesting of cassava. Matured roots were spread over 1.0 m and penetrated into a depth of 50 to 60 cm. It was concluded that difficult to readily mechanize harvesting as the tubers grow deeper.

Ashok (2003) studied the distinct biometric properties which included mean values of horizontal and vertical diameters of bulb and neck thickness for 10 special varieties of bulb onion. At the time of harvesting, he found out the mean horizontal diameter, mean vertical diameter of bulb and mean neck thickness were 61.80 to 74.80 mm, 44.20 to 64.00 mm and 9.60 to 16.20 mm respectively.



Khura *et al.* (2010) studied the crop parameters of the onion bulb and were found important in deciding the range of the design variables of the onion digger. The percent distribution of the onion below the soil surface indicated that 76 per cent onion bulbs were varied from 0 to 5 cm and 24.0 per cent within the range of 0 to 6 cm and reported that a saving in the cost digging was to the tune of 44 per cent of the price of manual digging. Damage to bulb within permissible limit of less than 5 per cent. The techno-economical evaluation ha h<sup>-1</sup> and the breakeven point was 122.20 h with the payback period of 3.85 years.

Balasubramanian *et al.* (2012) observed the physical properties of turmeric (*Curcuma longa*) rhizome was splited into three grades according to its major dimension. In grade I the physical properties varied between 25-35 mm, in grade II 35-45 mm and in grade III 45-55 mm. The average values of geometric properties *viz.*, length of 30.38 to 50.60 mm, breadth of 9.77 to 10.64 mm, thickness of 5.18 to 6.44 mm, arithmetic mean diameter of 15.82 to 21.91 mm, geometric mean diameter of 12.77 to 13.76 mm, square mean diameter of 24.24 to 28.58 mm, equivalent diameter of 17.61 to 21.41 mm, sphericity of 0.27 to 0.42, aspect ratio of 0.20 to 0.35, unit volume of 1641 to 2901 mm<sup>-3</sup>, surface area of 771 to 1265 mm<sup>2</sup> and shape factor of 1.63 to 1.77 for grades I, II & III were observed and frictional properties *viz.*, angle of repose of 37.57 to 38.90 deg. and coefficient of friction for aluminium sheet, mild steel sheet and plywood sheet for grades I, II and III were ranged between 0.69–0.81, 0.84–0.94, 0.80–0.86 respectively.

Khambe *et al.* (2012) measured the crop properties of garlic. He determined that leaves of garlic crop were in range of 5 to 7 numbers with 7 modal value, even as the plant length varied 64.90 to 75.50 mm, with mean value of 69.34 mm. The depth for bulb of garlic which affected the depth in the range 68 to 86 mm with a 76 mm as modal value. Polar diameter and equatorial diameter that affected rods spacing of windrower varied 33.13 to 40.48 and 30.26 to 36.82 mm and their mean values of 37.24 and 34.06 mm respectively. The average shape factor was measured as 0.96. Also, cutting resistance varied from 442.32 to 486.01 N and crushing resistance of garlic 202.54 to 231.53 N respectively.

Simonyan *et al.* (2013) determined the physical properties such as geometric mean diameter(GMD), arithmetic mean diameter (AMD), square mean diameter(SMD), equivalent mean diameter(EMD), aspect ratio, sphericity, mass, volume and particle density of two varieties of ginger at rhizome moisture contents of 73.64 and 77.13 per cent (w.b), for Umudike ginger I (UG I) and Umudike ginger II (UG II) respectively. The mean value of ginger rhizome sphericity was 0.43 and 0.50 and Aspect ratio 0.46 and 0.58 for UG I and UG II respectively. They suggested that processing machines with adjustable components were required for the two varieties of ginger rhizomes.

Yadav *et al.* (2013) conducted the field trials to determine the optimum date of planting and spacing of rhizome to obtain excellent growth and yield of ginger variety Mahima. Rhizomes planting on 15<sup>th</sup> April showed better growth, yield and attributing characters of yield. Among different spacing levels, the closer spacing of 25 × 15 cm recorded significantly higher plant height, green and dry ginger yield.

Ajav and Ogunlade (2014) calculated physical properties of ginger (*Zingiber officinale*) rhizomes *viz.*, diameters of ginger, geometric mean (GM), sphericity, bulk volume, bulk density of crop, surface area, angle of repose and the coefficient of friction. The mean value of major diameter of 112.0 mm, minor diameter of 38.3 mm, intermediate diameter of 72.3 mm, GM of 67.6 mm, sphericity of 0.61, bulk volume of 832.5 cm<sup>3</sup>, surface area of 147.0 cm<sup>2</sup>, bulk density of 0.92 g cm<sup>-3</sup> and angle of repose of ginger rhizome with 10.9 and 51.6 per cent (d.b) moisture content were measured respectively. The coefficient of friction on three various structural materials was obtained as 0.40 on glass, 0.49 on stainless steel and 0.55 on wood. The physical properties increased with an increase in the moisture content except for the sphericity and bulk density which were decreased as the moisture content increased.

Dhinesh Kumar and Ananda Kumar (2016) studied physical and engineering properties of turmeric (*Curcuma longa*) rhizome. They divided the turmeric samples into three grades as I: 30-40 mm, II: 40-50 mm and III: 50-60 mm according to its major dimensions. Geometric properties *viz.*, length, breadth, thickness, arithmetic mean diameter, geometric mean diameter, square mean diameter, equivalent diameter,

sphericity, aspect ratio, unit volume, surface area and shape factor were found out in the range of 30.18-48.54 mm, 9.72-10.62 mm, 5.12-6.38 mm, 14.72- 22.84 mm, 12.72-14.64 mm, 23.21-26.54 mm, 17.54-21.32 mm, 0.24-0.38, 0.18-0.32, 1591-2904 mm<sup>3</sup>, 772-1268 mm<sup>2</sup> and 1.61-1.74 for Grade I, II and III respectively. The gravimetric and frictional properties such as bulk density, true density, porosity and angle of repose were obtained as 264-348 kgm<sup>-3</sup>, 1340-1358 kg m<sup>-3</sup>, 72.51-78.90 per cent and 35.57-37.90 deg. respectively. Also, coefficient of friction with three different surfaces namely aluminium sheet, M.S sheet and plywood sheet were found out in the range 0.68-0.80, 0.85-0.96 and 0.82-0.88 respectively.

Yerima *et al.* (2016) measured the frictional properties of yellow ginger such as angle of repose on different surfaces of wood, mild steel, galvanized iron and stainless steel and other physical properties such as size, weight, tensile and compressive strength using simple analytical methods. The angle of repose which determined the flowability of the ginger in a hopper made of stainless steel was 35.0 deg. The tangent of this angle is the coefficient of friction between ginger and the stainless steel. The compressive stress was 1.75 N mm<sup>-2</sup> while that of tensile stress was 0.37 N mm<sup>-2</sup>.

Khambalkar *et al.* (2017) studied the physical properties of turmeric. The average length of rhizome was 58.11mm, breadth 36.71 mm and thickness of 30.17 mm. The average weight of rhizome was found 34.87 g. The average arithmetic mean diameter (AMD), square mean diameter (SMD), equivalent mean diameter (EMD), geometric mean diameter was observed as 41.66 mm, 70.22 mm, 50.57 mm and 39.80 mm. The average surface area and unit volume obtained were 4370.74 mm<sup>2</sup> and 25261.37 mm<sup>3</sup>. The average value of angle of repose, true density and bulk density were 18.060, 1018.95 and 529.66 kg m<sup>-3</sup>. The average shape factor was calculated as 0.03. The porosity ranged from 32 to 63 per cent. The average sphericity was found out as 0.71 mm.

Surendra Babu *et al.* (2017) conducted a test to elicit the details on performance of different ginger (*Zingiber officinale*) varieties under shade net condition. Among the vegetative characters observed, all the growth parameters such

as maximum plant height of 89.83cm, number of tillers per plant as 28.56, number of leaves per plant as 245.16, leaf area per plant as 49.39 cm<sup>2</sup>, leaf area index as 0.27 were detailed in the variety of Suprabha at 30 to 180 days after planting.

Wasiya *et al.* (2017) studied the physical properties of raw PTS 10 turmeric variety. A sample of 30 turmeric rhizomes (var. PTS 10) was selected for analyzing their physical properties. The average values of their geometric properties *viz.*, length (90.73 ± 12.12 mm), breadth (22.03 ± 2.25 mm), thickness (20.64 ± 2.2 mm), Geometric mean diameter (34.45 ± 2.96 mm), Arithmetic mean diameter (44.46 ± 4.49 mm), Square mean diameter (44.46 ± 4.49 mm), Equivalent diameter (48.18 ± 4.41 mm), Aspect ratio (0.25 ± 0.04), Unit volume (12413.53 ± 3185.09mm<sup>2</sup>), Surface area (3451.72 ± 585.75 mm<sup>3</sup>), sphericity (0.38 ± 0.04), shape factor (0.97 ± 0.03) were reported. The gravimetric properties *viz.*, Bulk density (468.417 ± 3.304 kg m<sup>-3</sup>), True density (785.13±9.141 kg m<sup>-3</sup>) and Porosity (0.403±0.009 per cent) were reported. The frictional properties *viz.*, Angle of repose (50.47 deg.), Coefficient of friction for Stainless steel (1.128±0.13), Coefficient of friction for Mild steel (1.172 ±0.097), Coefficient of friction for Galvanized iron (0.903 ±0.012) and Coefficient of friction for aluminium (0.903±0.023) were reported.

Bhawna *et al.* (2018) determined the physical properties of fresh Mahim variety of ginger rhizomes. The range of moisture content of fresh rhizomes was 76.18 -78.84 per cent. The average length, width and thickness of fresh ginger rhizome were 109.94 mm, 71.71 mm and 25.24 mm respectively. The mean values of geometric mean and sphericity of fresh rhizomes were 57.97 mm and 0.53 mm respectively. The average mass, volume and surface area of fresh rhizomes were 81.55 g, 77.75 cm<sup>3</sup> and 174.99 cm<sup>2</sup>. The range of bulk density, true density and porosity for fresh rhizomes were determined as 435.60 to 410.78 kg m<sup>-3</sup>, 1317.55 to 951.10 kg m<sup>-3</sup> and 66.94 to 56.81 per cent respectively. The angle of repose varies in the range of 39.99 -50.44 deg.

Abedi *et al.* (2019) studied the physical properties of two different varieties of potatoes that have important effect in the separation of tubers from clods and stones. The properties of potato *viz.*, dimension, mass, volume, sphericity, surface area and

density. In addition to these, the static coefficient of friction and rolling resistance for the tubers on 5 surfaces were found out. The outcomes of the study showed that most of the apparent properties for the Sante variety were greater than the Marfona variety of potato. The coefficient of friction was the maximum on a wood surface and minimum on galvanized sheet. The results proposed that the automatic separation of the potatoes from the unwanted materials with help of the properties of the tuber is feasible.

### 2.3 DEVELOPMENT AND TESTING OF ROOT CROP HARVESTERS

Anon. (1974) developed a tractor drawn digger at PAU, Ludhiana consisted of a 1220 mm long digger blade to uproot the groundnut. It was also provided to easily removal of the harvested groundnut and collection of groundnut by manual labour without any loss in the field.

Trivedi and Singh (1975) developed and evaluated digger for potato. The digger was evaluated at different travel speed of operation with three different blade types provided at a rake angle of 20 deg. The results obtained from the test showed that the convex-type blades perform well compared to concave-type with the complete recovery of tuber with 87.60-93.44 per cent while for concave blade it was 77.47 - 82.14 per cent and the operating depth of digger was maintained 200 mm to overcome damage and loss of the potato.

Evans *et al.* (1982) studied the effect of arrangement of tillage tools on draft required in sandy loam and clay soil. The arrangement made was the geometric orientation of adjacent tillage tools at three angles of 0, 30 and 60 deg. from the plane of the tools. Three radii of 610, 432 and 254 mm were selected at maximum depth of operation of 229 mm. They observed that for each configuration there was a depth at which specific draft reached a minimum which suggested the possibility of optimum depth of operation for a given configuration.

Harrison (1982) conducted test on inclined blades at different rake angles in a glass sided box and measured the forces on blades. It was noticed that the draft had

directly affected with positive rake angle and depth. The draft increased at slower rate at 20 deg. rake angle and increased extremely beyond the 20 deg. angle.

Misener and McMillan (1982) developed a potato digger. It consisted a hydraulic elevator kept at 15deg. angle to the horizontal. The gauge wheels with coulters were provided opposite the blade share of the potato digger. The test results revealed that the digger improved the harvest efficiency and there was no stir of adjacent hills of tubers.

Odigboh and Ahmed (1982) developed a cassava harvester which had a separately powered rotary ridge and flat type knives mounted in front of tractor to cut the stems and cassava root lifter mounted behind the tractor. The root lifter was a reciprocating V-shaped hoe mounted at the rear of the tractor. The rake angle was 20 deg. to achieve maximum penetration and scouring. The breakage to the cassava was 1.5 to 2.7 per cent in the ridge type and 9.7 to 10.3 per cent in flat type with undug being 1.8 to 2.5 and 15.1 to 16.6 percent respectively. Also calculated that the tractor operated cassava harvester could effectively save 20 man-h for harvesting 0.16 ha in cassava field.

Mizrack *et al.* (1983) evolved and examined a groundnut digger with picker conveyor suitable for sandy and clay loam soils. The top layer of the soil consisting of groundnuts that remained after completion harvesting was elevated by digger and removed the loosed soil. A vibrating rod in conveyor system separated efficaciously the clods of soil and cobs. The results showed that the digger could be efficiently recover groundnuts from clods at field efficiency of 75 per cent.

Saqib and Wright (1986) designed and tested vibratory diggers for harvesting of sweet potatoes in cloddy condition. They have investigated the effect of maximum acceleration of vibration and three variables *viz.*, velocity, amplitude of mechanism and vibration frequency on geometric mean diameter (GMD) of clod size and on per cent reduction in the soil cold in boil bulk density after operational trial. A rotary soil sieve was constructed and used for soil separation and clod size measurement. The operations of vibratory and non-vibratory type digger blades were compared with each other. Acceleration (Peak) values greater than 3 g produced around the same clod

break up and reduction in soil bulk density. Peak acceleration below 1 g resulted in poorer clod disintegrate.

Sharma and Verma (1986) designed and developed tractor operated an oscillatory type potato digger. The digging units consisted of straight blade and lifting rods were kept space to allow the cloddy soils and residual to drop on surface of the soil. A digger blade was tested at different frequencies ranged from 0 - 8 Hz and at forward speeds ranged 0.35 to 0.75 m s<sup>-1</sup>. The results revealed that the exposed and bruised tubers were 49.94 and 0.40 per cent respectively without any oscillation of the blade. However, at 8.0 Hz oscillation, 14.14 and 0.90 per cent the unexposed and bruised tubers were observed respectively. Estimated that the harvesting of tubers required about 600 man-h ha<sup>-1</sup> for manual digging over an animal drawn plough which reduced the labour to 300 man h ha<sup>-1</sup>. It was reported that the tractor operated digger required only 80-90 man-h ha<sup>-1</sup>.

Tiwari *et al.* (1994) conducted studies to evaluate the performance of three types of tractor drawn potato digger *viz.* oscillatory sieve potato digger soil separator, elevator conveyer digger and two mechanical diggers. The diggers were operated at different forward speed ranging from 0.29 to 1.2 ms<sup>-1</sup>. Its performance in terms of recovery, cut, bruise, damage and labour requirement for picking were evaluated. The maximum potato recovery of 98.77 and 85.07 percent were obtained with oscillatory sieve and elevator conveyer diggers with minimum forward speed of 0.29 ms<sup>-1</sup>. In case of mechanical diggers, the recovery was about 69.24 percent at a speed of 1.2 ms<sup>-1</sup>. The labour requirement for picking and collection of tubers was found minimum 103 man-h ha<sup>-1</sup> with oscillatory sieve digger and maximum 220 man-h ha<sup>-1</sup> with mechanical digger.

Jadhav *et al.* (1995) designed and developed a self-propelled onion digger with soil separator unit. They revealed that the per cent of damage bulbs varied 2.63 to 3.45 per cent and actual field capacity was 0.16 to 0.19 ha h<sup>-1</sup>. The digging efficiency was 66 to 93.23 per cent.

Fielke (1996) investigated the interaction effects of tillage implements cutting edge with parameters of soil at different forward speed of operation. He reported that

at higher speed of operation there was increased in the draft with increased cutting edge height which was found out to increase the forward and reduced movement of soil at the edge of the tool blade. He also found out that increased the edge of the tool blade height from 1 to 10 mm raised the draft by 40 to 75 per cent and increased the up thrust vertically by same magnitude.

Agbetoye *et al.* (1998) evaluated the performance of the three pre-lift soil loosening devices of cassava harvester. Three loosening tools of soil were modified for pre-lift loosening the soil in the uprooting of cassava and evaluated the device in terms of disturbance of soil and forces of soil acting on them in a soil bin as well as in the field condition. The results of the three devices showed that, the A type blade had the least soil forces and unit draft followed by the L-type tines. Further, the results indicated that the L-type of tines were most suitable for pre-lift soil loosening in harvesting due to their simple in fabrication reduced the damage to cassava. The results showed that a harvester incorporating L-type of tines as the pre-lift soil loosening device was technically feasible.

Dawelbeit and Wright (1999) designed and tested a vibratory digger for peanut (*Arachis Hypogea*, L.) in two different soil types. Tests were carried out at two forward speeds *viz.*, 2.40 and 4.80 km h<sup>-1</sup>, two different frequencies of vibration *viz.*, 9 and 16.7 Hz and two amplitudes of vibration *viz.*, 3.2 and 9.6 mm respectively. They observed that tractor forward speed and amplitude of vibration except frequencies, soil types were significantly affected the draft of the digger. Also it was noticed that the vibration not significantly affected peanut losses.

Sunil and Manjit (1999) developed an oscillating type potato digger. Digger consisted of horizontal oscillating mechanism. The optimum speed of travel of digger was 2.0-3.0 km h<sup>-1</sup>. Its field capacity (AFC) was 1.75 ha day<sup>-1</sup> and the tuber exposed was 85-90 per cent with respect to soil and field conditions.

Kathirvel *et al.* (2001) developed and tested ridge type sliding potato digger for power tiller. They compared performance evaluation of unit with traditional method on the basis of area coverage and damage of tuber. They reported that damage to potato tubers were 1.4 to 5.2 per cent as compared to 1.10 per cent damage with



manual harvesting of potatoes. The EFC of the machine was  $1.6 \text{ ha day}^{-1}$  while digging and soil separator efficiencies were 98.00 and 90.00 per cent, respectively. The bruised potato observed was 1.50 per cent and requirement of labour for picking of uprooted tubers was 50 per cent lesser than dig out by an elevator digger.

Gadir and Desa (2001) evaluated the performance of tractor drawn peanut digger blades *viz.*, flat type, curved type, V-type and double discs. The results showed that the V- type had lesser mean draft for increased digging depths for inclined angles of 0 to 40 deg. compared to other types of blades. It was concluded that the design of V- type digger was recommended for peanut harvester

Tiwari and Jethva (2001) developed and tested two row groundnut digger blade for small tractor and compared with traditional blades. The newly developed groundnut digger straight blade in the size of  $750 \times 250 \times 10 \text{ mm}$  was found out as the most suitable digging tool as it was performed with a field capacity of  $0.126 \text{ ha h}^{-1}$  with a field efficiency of 77.80 per cent and harvesting efficiency of 94 per cent.

Anon. (2002) developed tractor mounted turmeric digger at M.P.K.V, Rahuri. The blade length was 60 cm and depth of digging was 18-20cm. A set of lifting rods/gathering rods at the rear of the blade lifts the harvested rhizomes to drop it backward but the draft requirement was reported higher.

Kathirvel and Manian (2002) studied the effect of tool geometry on the harvesting efficiency of turmeric with various design parameters namely, blade shapes of crescent, straight and inverted-V, rake angles of 10, 15 and 20 deg. and lift rod lengths of 400, 500 and 550 mm. They found out that maximum harvesting efficiency and minimum damage was obtained for crescent shaped blade with the rake angle of 15 deg. and lift rod length of 500 mm.

Rangasamy *et al.* (2003) developed tractor drawn root crop harvester for turmeric rhizome. The forward speed of tractor with harvester was  $2.5 \text{ km h}^{-1}$ . The actual field capacity, harvesting efficiency and per cent damage of the root crop harvester was  $0.20 \text{ ha h}^{-1}$ , 99.0 per cent and lesser than 1 per cent respectively . The

efficiency of traditional method was 88.0 per cent with per cent damage of 8.0 per cent. The saving in cost was 26.0 per cent with harvester over traditional method.

Annamalai and Udayakumar (2007) conducted experimental trials on the optimisation of operational parameter of turmeric digger cum elevator. The harvester consisted different parts *viz.*, machine gear reduction box, uprooting unit, conveyor unit for turmeric and turmeric collector unit. The harvesting efficiency of harvester was 98.50 per cent. The design of conveyor unit was optimised for length, belt type, sieving screen and velocity of the conveyor. The conveying index was found out as 99.00 per cent. The actual field capacity was 0.16 ha h<sup>-1</sup>.

Sukhwinder *et al.* (2007) developed a tractor drawn offset-type digger for potato crop as an inter-crop in the sugarcane. Man power required for mechanical digging was found out as 60.0 per cent less than the manual method, whereas tuber damage was less than 2.0 per cent. There was no damage to sugarcane crop while harvesting potato except occasional trampling. About 0.25 ha h<sup>-1</sup> was field capacity of the offset type digger.

Ibrahim *et al.* (2008) invented a multipurpose device for digging potato and peanut with a vibrating mechanism. It was tested at three levels of forward speeds *viz.*, 1.8, 2.0 and 2.6 km h<sup>-1</sup> for potato and 1.40, 1.80 and 2.30 km h<sup>-1</sup> for peanut at three tilt angles of blade *viz.*, 12, 18 and 24 deg. When it was operated without using the vibrating unit, the per cent of losses, damage and harvesting efficiency were 17.43, 4.0 and 79.70 per cent respectively and when it was operated with vibrating unit these were 3.67 and 2.1 per cent respectively for potato. Similarly, when operated without the vibrating unit the percent losses, damage and harvester efficiency were 13.7, 2.75 and 93 per cent respectively and with the vibrating unit these were 3.1, 0.6 and 84.62 per cent respectively.

Sadeeq and Al-Rajaboo (2008) studied the effect of separating systems design of potato diggers on quantitative and qualitative loss of crop. A research was carried out in silt sandy soil in Mosul City, at three ground speeds of 1.5, 2 and 2.5 km h<sup>-1</sup> and two relative speeds of 1.38 and 1.15 km h<sup>-1</sup> for separation device to determine its effects on the quantitative and qualitative crop loss for two lifters. A significant

difference was recorded between the two separation devices of lifting machines, its effect on the quantitative loss, undamaged, slightly damaged and severely damaged tubers gave better results than the traditional one. The ground speed affected the lifting operation of the undamaged tubers. It gave the best results at 1.5 km h<sup>-1</sup> and also the ground speed didn't show any effect on other properties.

Munde *et al.* (2009) developed a pair of bullock drawn digger for turmeric. It was consisted of V-type blade with 70.0deg. angle of inclination and evaluated in field condition. The performance evaluation of digger was done in terms of percent damage, efficiency of digging, field efficiency (FE) and draft force requirement over existing implement and manual digging. He was observed requirement draft force for bullock operated turmeric digger was found out as 108 kgf. The rhizome damage was less than 10.7 per cent. On an average the digging efficiency and field efficiency were varied 86-95 and 71.0-88.0 per cent respectively.

Elbanna *et al.* (2010) fabricated a sugar beet harvesting machine. It was made for harvesting of single row of crop. He was designed by using two function such as pulling and topping. The pulling mechanism consisted of 3 important sugar beet harvester parts namely, two normal shares for losing the bund of the root, pulling belt and disk knife as a topping mechanism. Two opposite belts were provided to for push on leaves and pulling sugar roots, he was provide two opposite belts and topping the leaves before crop was dropped on rear surface of soil. The forward speed of machine was 1.50-2.00 km h<sup>-1</sup> with 50-65 hp tractor. The harvesting capacity was 0.5 ha h<sup>-1</sup>.

Khura *et al.* (2011) conducted performance evaluation of onion digger. He was measured draft requirement and digging efficiency of 6 shapes of blades for onion harvester and it was also found out as the mean draft force of 625.60 N achieved for inverted V- type blade. The optimum design values such as length of elevator, speed ratio of the unit and elevator slope were found out as 1.20 m, 1.25:1 and 15.0 deg. respectively. The efficiency of digging, separation index, bulb damage of onion harvester were found out as 97.7, 79.1 and 3.5 per cent respectively at 10.78 kN of draft.

Annamalai and Ravindra (2012) developed a power tiller operated harvester. It consisted of chisel type single digger blade and rubber conveyor cum vibrator. The mechanical harvester performed better with harvesting efficiency of 98.00 per cent at soil moisture content of 15.5 per cent (d.b) with 2.00 per cent damage. The effective field capacity was 0.08 ha h<sup>-1</sup>. In manual digging, the average efficiency of harvesting was 90.50 per cent and nut damage was 07.10 per cent.

Danuwat and Seree (2012) developed and tested a cassava digger with conveyor unit and the results indicated that the field capacity, field efficiency and conveying losses were 0.05 ha h<sup>-1</sup>, 59.10 per cent and 3.23 per cent respectively without losses.

Jayan and Sanchu (2012) reported a self-propelled coleus root crop harvester to alleviate the drudgery of uprooting the tuber. The harvester consisted of a 2 stroke diesel engine and harvesting units and main frame. The engine drives the ground wheel of engine with a chain and sprocket. The harvester was evaluated in a field condition with three different types of tines *viz.*, angular, flat and cylindrical types. It was reported that the specific fuel consumption increased with load and was found that the maximum with flat tines and minimum with cylindrical tines. The actual field capacity was the 0.07 ha h<sup>-1</sup> when operated with cylindrical tynes and the harvesting efficiency of 80.12 per cent was obtained for angular tynes.

Akinbamowo (2013) developed a cocoyam (*Xanthosoma spp.*) harvester. The machine was evaluated at different operational speeds *viz.*, 2.0, 4.0 and 6.0 km h<sup>-1</sup>, rake angles *viz.*, 15, 20 and 25 deg. and web speeds *viz.*, 540 and 1000 rpm. He was reported that the average harvest rate of 12.02 ton h<sup>-1</sup> and average digging efficiency of 84.20 per cent. The results showed that, when the harvester was operated at optimum speed of 6.0 km h<sup>-1</sup> for higher field capacity, 20 deg. angle of blade with the web speed at 1000 rpm, the optimum condition of digging most cocoyam cormels obtained with minimum losses at optimum speed of 4 km h<sup>-1</sup> and web speed of 540 rpm.

Khambe *et al.* (2013) fabricated a tractor operated garlic harvester for four rows. The garlic harvester was consisted of a V-type blade of 600 mm width, 10 mm

of thickness and 300 mm length. Soil separator unit was 100 cm long, 65 cm width and with 1 cm diameter rods having 5 cm spacing. Mean of harvesting efficiency of 96.12 percent, damage of 5.94 per cent, soil separation index of 26.0 per cent, power requirement of 4.54 kW and field capacity (FC) of harvester was 0.24 ha h<sup>-1</sup> with efficiency of 68.70 per cent.

Akhir *et al.* (2014) fabricated and tested a sweet potato digger. The 3 types of blades *viz.*, flat type, V-shaped and hoe type were constructed to find out the optimised draft. As compared all types of blade and depths of blade to measured draft force and the area of cross section of disturbance of soil showed that the highest draft force of 0.54 kN m<sup>-2</sup> was obtained by a flat type blade at the depth of 20.0 cm when the area of coverage was 0.18 m<sup>2</sup>. The V-type blade had average draft force of 0.51 kN m<sup>-2</sup>, with area of coverage of 0.185 m<sup>2</sup>. The best optimal solution was V-type blade with a 30 deg. rake angle at 20 cm depth.

Amin *et al.* (2014) modified and tested the digging harvesting machine to perform the effect of harvesting speeds on harvesting carrot as lifting, unlifting, damaged, undamaged and machine productivity. The experiments were conducted on carrot harvesting under three different levels of separator lengths of 450, 700 and 1200 mm, reciprocated cam with link lengths of 180, 210 and 240 mm and three forward speeds of 3.6, 5.1 and 7.2 km h<sup>-1</sup> and three shares of sweeping, nose and shovel. The maximum value of carrot lifting efficiency was 99 per cent recorded at nose shape type, 3.6 km h<sup>-1</sup> harvesting speed, separator length 1200 mm and reciprocated cam with link length of 210 mm. At reciprocated cam with link length of 180 mm, increased forward speed from 3.6 to 7.2 km h<sup>-1</sup> increased the unlifted of 6, 7 and 9 per cent times at separator length of 450, 700 and 1200 mm respectively. Generally, increasing harvesting speed increased carrot damage. Increasing forward speed from 3.6 to 7.2 km h<sup>-1</sup> decreased productivity under all treatments at reciprocated cam with link length of 180, 210 and 240 mm.

Amponsah *et al.* (2014) conducted field trials in the experimental plot to find out the efficiency of four manual harvesting mechanisms for tapioca in terms of actual field capacity (AFC), drudgery level and damage. The harvesting of tapioca was done

by using developed harvester, hoe tool and manual uprooting. The results revealed that, under “upland mound method” of land preparation, the developed harvester recorded the least harvesting capacity was 16.73 man-h ha<sup>-1</sup> whereas the use of hoe tool recorded the highest which was 43.72 man-h ha<sup>-1</sup> respectively.

Aziz *et al.* (2014) prototyped and developed a single row tractor operated potato digger with rotary type blade. In order to separate the soil from potato tuber, a helix containing bars of 9 mm Ø and 2.6 cm length were separately attached to digger. The digger was tested at field with speed of operation, rotational speed and angle of blade. The results showed that at speed of operation 1.5 to 3 km h<sup>-1</sup>, rotational speed of 20 to 25 rpm and blade angle of 10 to 15 deg. it worked efficiently with 4.0 per cent damage of potato crop.

Hong *et al.* (2014) developed tractor mounted welsh onion harvester. The harvester performance was evaluated at the forward speeds of 5.0, 11.4 and 15.8 cm s<sup>-1</sup> and compared performance parameters of harvester by the performance efficiency, harvesting rate and damage of the onion harvester. It was shown that work efficiency of the harvester was increased as the forward speed increased. Although the damage of the harvested welsh onions at different forward speeds *viz.*, 5.0, 11.4 and 15.8 cm s<sup>-1</sup>, increased proportionally from 4.55 to 6.53 per cent and to 11.29 per cent respectively. The residual quantity of soil on the harvested welsh onions was about 0.24 per cent of their weight showed excellent soil-removal of the harvester.

Mareppa *et al.* (2014) fabricated and evaluated a self-propelled groundnut digger. They tested digger at various levels of evaluation parameters *viz.*, moisture contents of 10, 12.5 and 15 per cent, rake angles of 10, 15 and 20 deg. and forward speeds of 1.50, 2.00 and 2.50 km h<sup>-1</sup>. The performance evaluation of the digger was found out as excellent moisture content at 15 per cent with 15 deg. rake angle at 2 km h<sup>-1</sup> forward speed. The highest digging of 96.95 per cent was observed with a least draft force of 1558.0 N.

Mehta and Yadav (2015) developed and evaluated the tractor operated onion harvester. The developed onion harvester was able to dig the onion plants with blub and laid these on the surface of bed unevenly. The theoretical field capacity of

harvester was found out as 0.57 ha h<sup>-1</sup> while actual field capacity was 0.45 ha h<sup>-1</sup> with the field efficiency of 78.95 per cent. The harvesting efficiency was found out as 95.75 and 96.45 per cent for number basis and weight basis respectively. The savings in time, consumption energy and harvesting cost of onion bulb were 87.64, 46.23 and 78.86 per cent over manual method.

Moayad *et al.* (2014) designed, developed and tested a self-propelled groundnut harvester. Computer simulation method was applied to select the optimum design of diggers before fabrication. It was reported that the operational parameters of theoretical field capacity (TFC) was 0.061 ha h<sup>-1</sup> and effective field capacity (EFC) was 0.048 ha h<sup>-1</sup> in sandy soil and efficiency of harvester obtained in clay soil was more than that in sandy soil by 1.20 per cent.

Singh (2014) developed and tested the performance of the digger for onion crop. The digger was operated at a speed of 4.0 km h<sup>-1</sup> with minimum losses and recorded actual field capacity of 0.46 ha h<sup>-1</sup>. The mean depth of digger blade was 76.20 mm. The study revealed that time required for digger operation including and excluding the time in turning were 3.10 h ha<sup>-1</sup> and 2.38 h ha<sup>-1</sup> respectively at a depth of 76.20 mm. The lift per cent, mean digging efficiency and damage percent were 94.9, 89.8 and 5.1 per cent respectively. It was also found out that there were 58 and 49 per cent of saving in labour and cost.

Bangar *et al.* (2016) developed a multipurpose digger for potatoes. It was used for separating and conveying it over the surface of soil with minimum losses and damage. Potato harvester was developed with soil tuber separation mechanism unit. The digger was tested at three different levels of forward speeds *viz.*, 1.8, 2.0 and 2.6 km h<sup>-1</sup> respectively for potato and three different tilt angles *viz.*, 12, 18 and 24 deg. The optimum results were obtained at 22.0 cm depth of harvesting, 2.60 km h<sup>-1</sup> speed of operation and 18 deg. tilt angle.

Younus and Jayan (2016) modified and tested a self-propelled root crop harvester for coleus. It was consisted of a prime mover of machine, cutter bar knife and rotary type blade. As and when tiller moves, the cutter bar penetrated into the soil at a depth of 10 to 15 cm and at an angle of 40 deg. to uproot the tubers.

Jarugula (2017) designed and developed tractor operated onion digger and evaluated its performance. The harvesting efficiency was 100 per cent with all the rake angle and travel speed. The damage percentage and draft requirement were 2.3 per cent and 550 N at rake angle of 20 deg. with forward speed of 2 km h<sup>-1</sup>. The field capacity of 0.19 ha h<sup>-1</sup>, field efficiency of 82.2 per cent and minimum power requirement of 3.03 kW was obtained at same combination. The total cost for fabricating the digger was Rs. 11200 and cost of operation was Rs. 1934.0 per ha. The harvester could save about Rs. 19190 per ha as compared to the manual harvesting of onion Rs. 21125 per ha, the BEP for the onion digger was 23.6 h which was of 47.50 per cent of utility of machine. The payback period of the digger was 1.06 years.

Abdalla *et al.* (2018) studied the effect of performance parameters of potato harvester such as forward speeds *viz.*, 4.40, 5.60 and 6.70 km h<sup>-1</sup>, depth of digging unit *viz.*, 16, 18 and 21 cm and the inclination of conveyer *viz.*, 15 and 20 deg. on wheel slip, effective field capacity (EFC) and consumption of fuel. As the depth of digger increased from 16 to 18 cm, the uprooting of potatoes increased in the range of 93.42 to 94.42 per cent and decreased from 94.42 to 87.72 per cent when the digging depth decreased from 21 cm to 18 cm. The minimum per cent of scuffed, peeler, more damaged tubers and total damage of 0.20, 0.00, 1.60 and 21.90 per cent respectively were recorded at a forward speed of 6.70 km h<sup>-1</sup>, while the maximum percent of scuffed, peeler and more damage tubers of 2.10, 0.30 and 2.70 per cent respectively were recorded at a forward speed of 4.3 km h<sup>-1</sup>.

Babalola *et al.* (2018) developed low cost manually operated cassava harvester using hydraulic ram and plunger system. The harvester consisted base frame, support stand, lifting arm, lifting medium and the clamp. The hydraulic power source capable of lifting 5 tonne of weight was adopted with a human effort of 50 N (5 kg). No cassava root breakage was observed during harvesting and lifting efficiency of the device as 100 per cent.

Kamran *et al.* (2018) fabricated and done performance evaluation of carrot digger mechanically. They selected a field of 0.75 ha for machine evaluation. Optimized the variables for carrot digger with 3.1 km h<sup>-1</sup> as forward speed. The



average field capacity and field efficiency of carrot digger were calculated as 0.19 ha h<sup>-1</sup> and 45 per cent respectively. The BEP of this machine was achieved after 170 hours of operation.

Kawale *et al.* (2018) developed and tested a tractor drawn ginger harvester cum elevator at a varying forward speed. The harvester cum elevator was consisted of a main frame, digging unit, gauge wheel, vibrating mechanism unit, power transmission system and conveying unit. The draft and power requirement for harvesting ginger was found out as 2625.82 N and 1.82 kW respectively. Fuel consumption for particular operation was observed as 5.03 l h<sup>-1</sup>. Theoretical field capacity, actual field capacity and field efficiency of ginger harvester cum elevator were 0.22 ha h<sup>-1</sup>, 0.18 ha h<sup>-1</sup> and 81.80 ha h<sup>-1</sup> respectively. The digging efficiency, damage of rhizome, separation index and conveying efficiency were observed as 99.18 ha h<sup>-1</sup>, 1.06 per cent, 85.38 per cent and 99.72 per cent respectively.

Naresh *et al.* (2018) developed a tractor drawn root crop digger for carrot crop. The digger was consisted of digging blade, conveyer unit, de-topping unit, collection unit, power transmission system and main frame. A sweep type digging blade was used for uprooting the carrot crop and roller chains with triple pitch were used to hold the carrots leaves uprooted by the digging unit. The digging efficiency was 100 per cent, picking efficiency was 61.56 per cent and cutting efficiency of de-topping unit was 100 per cent respectively. The actual field capacity and field efficiency of the digger were 0.11 ha h<sup>-1</sup> and 61.70 per cent respectively. The saving in time and cost were found out as 94.00 and 63.36 per cent respectively for digger over manual method of harvesting.

Pramod *et al.* (2018) designed and constructed potato digger cum elevator which was used for digging and elevating the soil and potatoes simultaneously. It reduced 75 per cent labour and 50 per cent operating time consumed to conventional method of digging with spades, kudali and khurpi. It also reduced 4 to 5 per cent in harvesting losses. It was found highly economical, time saving, reducing labour charges with minimum damages. The test results of the machine such as actual field capacity, digging efficiency, damage of tubers and field efficiency were observed as

0.30 - 040  $\text{hah}^{-1}$ , 94 - 96 and 76.5 per cent respectively. It was observed that at elevator height of 40cm the implement was working more efficiently rather than at other heights.

Wajire *et al.* (2018) developed a tractor operated digger cum elevator for harvesting of turmeric and ginger. The harvester consisted of soil cutting blade, crop soil separator unit, main frame and the hitching arrangement. Over all working of the machine was satisfactory with the average field efficiency 82.73 and 81.70 per cent for turmeric and ginger respectively. Also observed that digging efficiency was 98.18 and 98.20 per cent and the average damage percentage due to mechanical harvesting was 3.51 and 2.83 per cent for turmeric and ginger, respectively.

Mohamed *et al.* (2019) fabricated a mini-tractor operated digger for coleus tuber. The field experimental trials were conducted at different forward speeds viz., 1.00, 1.50 and 2.00  $\text{km h}^{-1}$  and depths of 10 and 15 cm. The per cent damage of coleus was negligible and the efficiency of digger was found out as 89.0 per cent and the harvesting capacity of the coleus digger was 0.0365  $\text{ha h}^{-1}$ . Cost of saving in coleus digger was 40.0 per cent in comparison with manual harvesting of coleus.

Narender *et al.* (2019) optimised the performance parameters of root crop digger for potato crop. The digger was tested at three different levels of forward speeds, viz., 2.30, 2.80 and 3.30  $\text{km h}^{-1}$  and three levels of rake angles viz., 17, 20, and 23 deg. the experiment was conducted on the optimised parameters of exposed, undug, cut, bruised percentage and the digging efficiency. The best performance of the digger was obtained at forward speed 2.3  $\text{km h}^{-1}$  and the rake angle 23 deg. for potato crop at which the exposed, undug, cu, bruised percentage and the digging efficiency was found out as 90.62, 2.10, 1.71, 2.48, and 97.90 per cent respectively.

Shailaja *et al.* (2019) developed a tractor drawn turmeric digger cum separator. The turmeric digger cum separator was consisted of a main frame of the digger, digging blade, gauge wheel, power transmission system and conveyer unit. At the time of field evaluation of turmeric digger cum separator, draft force, efficiency of digging, damage of rhizome and fuel consumption of tractor, separation index, field capacity and power requirement were determined. The machine was evaluated at three

different shapes of digging unit and at three different levels of forward speeds *i.e.* 1.5, 3.0 and 4.5 km h<sup>-1</sup>. The draft and power requirement for harvesting turmeric was found as 2199.0 N and 0.91 kW respectively. Fuel consumption and field capacity was observed as 6.12 l h<sup>-1</sup> and 0.47 ha h<sup>-1</sup> respectively and the digging efficiency, damage of rhizome and separation index of turmeric were recorded as 97.35 per cent, 3.34 per cent and 0.24 per cent.

Xie *et al.* (2019) conducted experimental trials the swing separating sieve on a potato digger. They conducted experimental trials for achieving the proper potato-soil mixture distribution and the parameters of the swing separating sieve, potato digger. In each part, the experimental factors were rotational speed of crank, inclination of sieve and forward speed. It was observed that the coverage of the potato-soil mixture on the separating sieve reduced gradually with the increased in rotational speed of crank and sieve inclination. Inversely, as the forward speed was raised, the coverage of the potato-soil mixture gradually increased. The potato harvesting efficiency was 99.49 per cent and the damage of potato was 0.87 per cent.

---

## **MATERIALS AND METHODS**

## CHAPTER III

### MATERIALS AND METHODS

This chapter deals with the methods adopted in design, development and testing of root crop harvester and the experimental methodology is used to evaluate the machine as influenced by the soil, crop, machine and operational parameters. Parameters of the harvesting mechanism *viz.*, blade geometry, including soil interaction and conveying characteristics of the produce harvested are discussed. Further, the levels of the variables selected for the investigation and the optimization procedure for achieving maximum efficiency of harvesting of tubers/rhizomes such as coleus, ginger and turmeric are also explained.

The development work was carried out at the research workshop of the Department of FMPE, KCAET, Tavanur and field trials were conducted in KCAET, Tavanur, RARS Pattambi, State Seed Complex, Munderi and different farmers' fields at Thrissur and Palakkad districts. The cost economics of the prototype unit has been worked out and discussed.

The important soil, crop and machine parameters influencing the design and development of harvester of selected root crops *viz.*, coleus, ginger and turmeric are discussed below. The soil parameters were only considered at the time of harvest while crop and machine parameters were considered throughout the operation.

#### 3.1 SOIL PARAMETERS

The soil parameters such as type, moisture content, bulk density, cone index and shear strength influencing design, development and performance of tractor drawn root crop harvester for harvesting of coleus, ginger and turmeric were identified and measured. The methods of measurement of these properties are explained briefly.

##### 3.1.1 Type of soil

The crops such as coleus, ginger and turmeric are mainly cultivated in Malappuram, Thrissur and Palakkad districts. Soil samples were selected from

these areas. The five soil samples at five different locations of the experimental plots were collected randomly and the sieve analysis of the soil was conducted. The type of soil was then confirmed from USDA chart.

### 3.1.2 Moisture content

Moisture content is the ratio of the weight of water to the weight of the solids. The moisture content of the sample in per cent dry basis was determined by using the equation.

$$MC = \frac{W_1 - W_2}{W_1} \times 100 \quad \dots (3.1)$$

Where,

- MC = Soil moisture content, % (d.b)
- W<sub>1</sub> = Initial weight of soil sample, g
- W<sub>2</sub> = Final weight of dry soil sample, g

It is expressed in percentage and is found out by oven dry method. Soil samples of different locations were collected from the fields at depths of 0-5, 5-10, 10-15 and 15-20 cm. The soil samples of 50 g each were collected in different containers and placed in a hot electric oven under controlled temperature of 105 °C for a time period of 24 hours (Angelis, 2007). The weight before and after drying were found out using an electronic weighing balance having a sensitivity of 0.01 g. Moisture content of soil affects the draft of implement and slip. Soil having more moisture content gives more slip and hence increases the draft. Soil moisture plays an important role for the growth of coleus, ginger and turmeric and optimum soil moisture is needed at the time of harvest to minimize field losses and energy input.

### 3.1.3 Bulk density

The compactness of the soil is determined by the bulk density. The bulk density was found out by using the equation,

$$\rho = \frac{M}{V} \quad \dots (3.2)$$

Where,

- $\rho$  = Bulk density of soil,  $\text{g cm}^{-3}$   
 $M$  = Mass of the oven dried soil, g  
 $V$  = Volume of core sampler,  $\text{cm}^3$

Initially volume of a cylinder was determined by measuring the internal diameter (10 cm) and height of core cutter (12.5 cm) and empty core cutter was weighed. A small area of ( $30 \times 30 \text{ cm}^2$ ) of the soil to be tested in the experimental field was exposed and surface was levelled. A cylindrical core cutter was pressed into the soil mass using the rammer with dolley placed over the top of the core cutter. Pressing was stopped when the dolley protrudes about 15 mm above the surface. Surrounding soil of core cutter was removed and it was taken out. Top and bottom surface of the core cutter was carefully trimmed using a straight edge. Core cutter filled with soil was removed and weighed. Bulk density of soil was measured by using equation (3.2)

### **3.1.4 Cone index**

Soil cone penetrometer was used to measure the penetration resistance of the soil. The cone penetrometer was positioned in the field and slightly pressed on the handle. Cone index provides an indication of soil resistance and it is expressed as force per square centimetre required for a cone of standard base area to penetrate into soil to different depths. Cone index for the same soil varies with the cone apex angle, area of cone base and depth of penetration. A uniform force was placed on the handle and deflection of dial gauge was noted for 5 cm in depth. The solid stem penetrated into the soil and force was measured from the deflection of the needle of proving ring corresponding to the insertion of 30 deg. cone. The cone index was measured for 5, 10, 15 and 20 cm depth and recorded manually. The same procedure was repeated to measure cone index at various location of the study area (Venkatareddy, 2018).

### 3.1.5 Shear strength

Shear strength of a soil is the maximum resistance offered by the soil to shearing stresses (Venkatareddy, 2018). The Shear strength was found out by using the equation,

$$S = \frac{T}{\pi \left( \frac{D^2 H}{2} + \frac{D^3}{6} \right)} \quad \dots 3.3$$

Where,

- S = Shear strength, kgf cm<sup>-2</sup>
- T = Torque, kgf cm
- D = Overall diameter of vane, cm
- H = Height of the vane, cm
- If H = 2D the equation reduces to

$$S = \frac{3T}{11D^3} \quad \dots 3.4$$

The *in-situ* measurement of shear strength of soil was carried out using a vane shear test apparatus (Make – AIMIL (CIVIL)). Bore holes at depths of 30, 45 and 60 cm were dug out. Casing was extended up to these depths and hence the entire unit was fixed at the location during the test. Torque applicator was fixed on the stand with the help of spikes. A vane size of 37.5 mm diameter was selected and it was connected to the vane rod having same female thread. The vane was lowered to the above required depths. It was pushed downward with a moderate steady force up to a depth of 50 mm below the bottom of the bore hole and allowed to move further for 5 minutes after the insertion of the vane. The initial dial gauge reading was set to zero and gear handle was turned so that the vane was rotated at the rate of 0.1 deg. per second, this in turn help to get a uniform rate of 12 turns per minute. Vane was rotated completely ten times to disturb the soil. Torque indicator dial gauge reading was noted at 30 s interval and the rotation of vane was continued until the reading drops appreciable from the maximum.



### 3.2 CROP PARAMETERS

The major crop parameters of coleus, ginger and turmeric namely biometric, physical and frictional properties are important for the design and development of digging and soil separator units of the harvester. The variety of the crops also affect the design of the harvester as the growth factor and foliage varies according to the variety. The commonly grown variety of coleus are Nidhi and Sreedhara and IISR-Rejatha and IISR-Mahima for ginger and Alleppey for turmeric respectively, were used for evaluating the performance of root crop harvester.

The biometric parameters of coleus, ginger and turmeric are important for the design of digging blades of root crop harvester. These properties were measured at the time of harvest using standard test procedure. The position of tuber/rhizome with respect to ground surface and the quantity of material to be handled were assessed. Before operating in the field the following related properties were also observed and recorded.

#### **3.2.1 Number of leaves**

The crop canopy is indicated by number of leaves spread on cultivated beds. Twenty five beds of 10 m length were randomly selected and number of leaves were counted.

#### **3.2.2 Height**

The height of the plant was the deciding factor for design of the throat and total length of soil separator unit for proper soil separation. Twenty five plants were selected randomly and its heights were measured with a scale and the mean value was determined. The height of plant decides the handling of crop at the time of harvesting by the machine.

#### **3.2.3 Depth of tuber/rhizome**

The depth of tubers/rhizomes in soil was estimated to find the volume of soil to be handled by digging and soil separator units of the harvester. Randomly selected twenty five plants each from coleus, ginger and turmeric in the study area

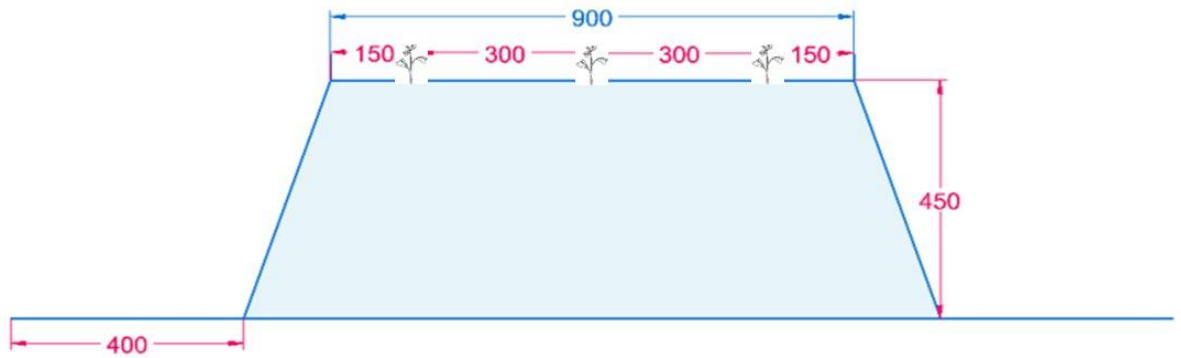
were measured by using a scale and a flat plate. Vertical soil section was first cut along the plant to expose the tuber/rhizome of a standing plant. A flat plate was kept on the ground and a scale was placed vertically to the soil up to the bottom of root crop plant.

#### **3.2.4 Plant density**

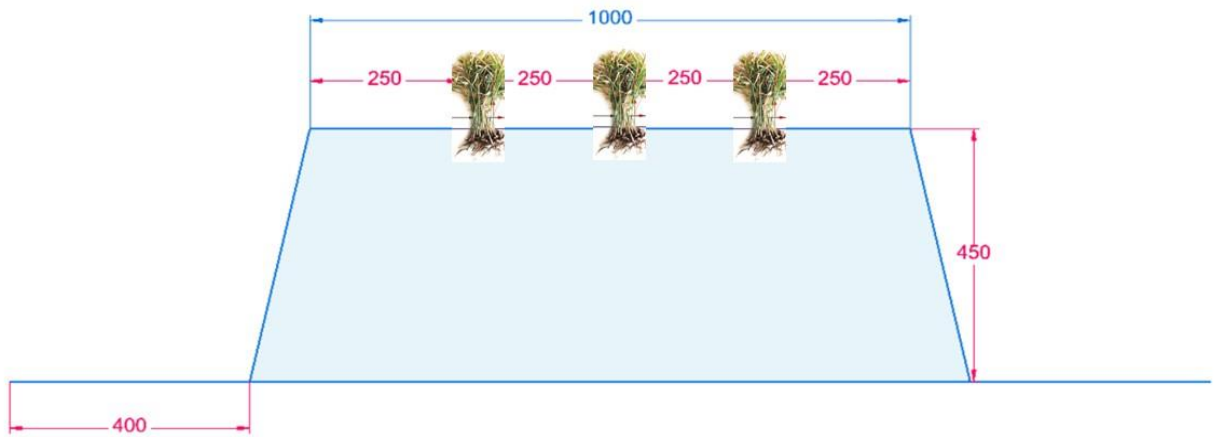
The density of plant is an important parameter in determining the volume of crop handled by the digging and soil separator units of the harvester. Plant density of crop in one square meter area was recorded.

#### **3.2.5 Spacing**

The coleus, ginger and turmeric were planted in raised bed system with a bed width of 900 mm and covering two to three rows as shown in Fig.3.1 and 3.2 (KAU, 2016). The height of raised bed was 300 to 450 mm. The spacing between the rows 200 to 300 mm and plants as 150 to 200 mm were kept to facilitate easy uprooting of the tubers/rhizomes. The plant spacing and size of beds are shown in Fig 3.1. and 3.2 and Plate. 3.1 and 3.2 respectively.



**Fig. 3.1. Raised beds for coleus**



**All dimensions are in mm**

**Fig. 3.2. Raised beds for ginger and turmeric**



**Plate 3.1 Width of the raised bed**



**Plate 3.2 Height of bed**

### 3.2.6 Soil tuber/rhizome composite

The spread of tuber/rhizome in soil lateral and vertical directions varied w.r.t the varieties (Plate 3.3). Tuber/rhizome spread affect the design of digging unit. The spread of twenty five clumps were selected at random and measured using a scale by digging the soil adjacent to the plant on the raised bed. Mass per unit volume of soil tuber/rhizome composite was recorded as soil-rhizome mass. It is expressed in  $\text{kg m}^{-3}$ . The weight of tuber/rhizome alone varies from 250 to 800 g for different varieties of coleus, ginger and turmeric crops. Soil is adhered all around the tuber/rhizome when it was dug out, and hence the complete weight was measured. The weight tuber/rhizome without soil was separately taken and the difference in weight was recorded as weight of the soil. The overall weight of the soil tuber/ rhizome composite determines the material handling capacity of the machine.

Each hill contains one or more mother rhizomes which produce 4 to 10 primary fingers. Later stages the secondary fingers were usually come out with 8 to 20 shoots. The total number of fingers per hill influences the volume of crop to be handled. A minimum number of fingers were observed as twenty five randomly at the time of harvest.



**Plate 3.3 Soil tuber/rhizome composite**

### 3.3 PHYSICAL PROPERTIES OF TUBER/RHIZOME

The physical properties of coleus, ginger and turmeric *viz.*, size, sphericity, bulk volume, bulk density, tuber/rhizome index and surface area were determined by using standard procedures.

#### 3.3.1 Size

The size of fresh tuber/rhizome was determined by measuring the dimensions along the three principal axes namely, major (length), intermediate (width) and minor (thickness) using Vernier calipers least count of 0.01 cm) and thickness were measured using digital calipers. The size was recorded for ten rhizomes/tubers and an average size was computed (Jayashree and Visvanathan, 2011). The geometric mean of the coleus, ginger and turmeric were determined by measuring the major, minor and intermediate axes of the tuber/rhizome. The geometric mean was calculated using the equation described by Mohsenin (1986).

$$\text{Geometric mean} = (xyz)^{\frac{1}{3}} \quad \dots (3.5)$$

Where,

- x = Major diameter of tubers/rhizomes, mm
- y = Intermediate diameter of tubers/rhizomes, mm
- z = Minor diameter of tubers/rhizomes, mm

#### 3.3.2 Sphericity

The sphericity is defined as the ratio of the diameter of the largest circumscribing sphere (mm) to the diameter of the smallest circumscribing sphere (mm). Diameters of the tuber at the larger and smaller circumscribing sphere were recorded and sphericity was calculated (Ajav and Ogunlade, 2014).

$$S = \frac{\sqrt[3]{yz}}{x} \quad \dots (3.6)$$

Where,

S = Sphericity

### 3.3.3 Bulk volume

The bulk volume of the tubers/rhizomes was determined by using Archimedes's principle as described by Nelkon (2005). The sample was weighed and immersed in a measuring cylinder containing a known volume of water thus leading to an increase (rise) in the water volume. The difference between the new level of water in the measuring cylinder and the initial level of water was recorded as the bulk volume of the tuber/rhizome.

### 3.3.4 Bulk density

The bulk density of the coleus, ginger and turmeric was determined as the ratio of bulk weight of tuber/rhizome to the bulk volume of tuber/rhizome (Ajav and Ogunlade, 2014). A container of known volume of inner dimensions 550 x 280 x 350 mm was taken and weighed in a physical balance. Then it was completely filled with freshly harvested tuber/rhizomes and was weighed again. The bulk density was calculated by using the formula,

$$B_R = \frac{W_{tc} - W_c}{V_c} \quad \dots (3.7)$$

Where,

$B_R$  = Bulk density of tuber/rhizome,  $\text{kg m}^{-3}$

$W_{tc}$  = Weight of container filled with tuber/rhizome, kg

$W_c$  = Weight of empty container, kg

$V_c$  = Volume of container,  $\text{m}^3$

The bulk density was measured for ten samples and the mean value was calculated.

### 3.3.5 Rhizome index (I)

Rhizome index is the percentage ratio of rhizome's greater length to the product of greater width and greatest thickness of rhizome (Annamalai and Udayakumar, 2007).

$$I = \frac{L}{WT} \times 100 \quad \dots (3.8)$$

Where,

- I = Rhizome index
- L = Greatest length of tuber/rhizome, mm
- W = Greatest width of tuber/rhizome, mm
- T = Greatest thickness of tuber/rhizome, mm

The rhizome index was measured for ten samples and the mean value was calculated.

### 3.3.6 Surface area

The surface area was estimated using the relationship given by Asairo and Anthony (2011). The surface area was measured for ten samples and the mean value was calculated.

$$S = \pi Gm^2 \quad \dots (3.9)$$

Where,

- S = Surface area, mm<sup>2</sup>
- Gm = Geometric mean diameter, mm

### 3.3.7 Moisture content

Moisture content of tuber/rhizome is an important parameter which has direct impact on harvesting and quality of the tuber/rhizome. The moisture content of tuber/rhizome was measured by gravimetric method. 50 g of sample were weighed and put in the empty weighed moisture box, the weight of sample with box were recorded. The moisture box is kept in hot air oven at 105°C ± 2 °C for 24 hours. After 24 hours the weight of the moisture box with sample is measured. The moisture content of tuber/rhizome can be measured by using the following formula.

$$M_w = \frac{M_2 - M_3}{M_2 - M_1} \times 100 \quad \dots (3.10)$$

Where,



- $M_w$  = Moisture content, % (w.b)  
 $M_1$  = weight of moisture box, g  
 $M_2$  = weight of moisture box + tuber/rhizome before drying, g  
 $M_3$  = weight of moisture box + tuber/rhizome after drying, g

### 3.4 FRICTIONAL PROPERTIES OF TUBER/RHIZOME

The frictional properties of coleus, ginger and turmeric rhizome *viz.*, coefficient of friction, angle of repose and texture were determined by the following standard procedures.

#### 3.4.1 Coefficient of friction

The static coefficient of friction was determined with respect to each of the following three structural materials on the tilting table: stainless steel, plywood and glass. The tubers/rhizomes of coleus, ginger and turmeric were placed parallel to the direction of motion and the table was raised gently by a screw device. The angle at which the rhizomes/tubers begin to slide (the angle of inclination) was observed on a graduated scale fitted on the tilting table. This was repeated three times for each material. The coefficient of friction was calculated as the tangent of this using the equation given by (Olaoye, 2000)

$$\mu = \tan \theta \quad \dots (3.11)$$

Where,

$\mu$  = Static Coefficient of friction, decimal

$\theta$  = Angle of Inclination, deg.

#### 3.4.2 Angle of repose

The angle of repose is an angle made by rhizomes/tubers with the horizontal surface when heaped from a known height (Olaoye, 2000). A bag containing 25 kg of coleus, ginger and turmeric tubers/rhizomes was heaped over a horizontal surface. The slant height of the heap was determined and radius of the heap was calculated from the circumference of the heap. The angle of repose was calculated by using the formula:

$$\theta = \tan^{-1}\left(\frac{h}{l}\right) \quad \dots (3.12)$$

Where,

$\theta$  = Angle of repose, deg.

$h$  = Height of the heap of tubers/rhizomes, cm

$l$  = Bottom diameter of heap formed from the tubers/rhizomes, cm

### 3.4.3 Texture

Important quality parameters which affect the consumer acceptability of coleus, ginger and turmeric is firmness. This parameter was determined using Texture Analyzer. The instrument Shimadzu (EZ) texture analyser has Trapezium texture analyzer software installed to a personal computer. The instrument consists of the test-bed and the adjustable controller. It is a system with a maximum stroke of 500 mm and a capacity of 500 N. It has a test speed range from 0.001 to 1000 mm m<sup>-1</sup> (at all loads) and the maximum return speed is 1500 mm/min. This system is ideal and effective for testing of texture profile analysis. It can be fixed with a variety of jigs and fixtures. The sample was kept on the test bed of the instrument and was subjected to compression by tooth pushed jig with depth of 50 mm. From interactive data processing screen of the texture analysis software, the force deformation curve was used for the measurement the firmness or hardness (peak force).

## 3.5 MACHINE PARAMETERS

The relevant machine parameters, *viz.*, blade geometry, rake angle, diameter of crank, spring tension and speed of the crank are the important parameters affecting the performance of the root crop harvester.

### 3.5.1 Blade geometry

The geometry of the digging blade includes its size and shape. The efficiency of the root crop harvester mainly depends on the geometry of blade. Hence, it is essential to select and optimize the blade geometry in order to obtain

maximum efficiency of root crop harvester. The blade geometry was decided based on the previous research works as shown in Table 3.1.

**Table 3.1 Research works on root crop harvesters with different digging blades**

Sl. No.	Digging blade		Power source	Harvesting efficiency, Per cent	Crop	Authors
	Shape	Size, mm				
1.	Crescent	457	Bullock	80.00	Groundnut	Narayana Rao, 1974
2.	V-shaped	200	Tractor	98.80	Sugar beet	Srivastava and Yadhav, 1978
3.	V-shaped	900	Tractor	97.00	Cassava	Odigboh and Ahmed, 1982
4.	Trapezoidal	250	Power tiller	-	Potato	Misener, 1982
5.	Share type	600	Bullock	86.24	Groundnut	Awadhawal <i>et al.</i> , 1995
6.	V-shaped	700	Power tiller	93.20	Onion	Jadhav <i>et al.</i> , 1995
7.	Straight	825	Tractor	95.00	Turmeric	Murugesan and Tajuddin, 1995
8.	Straight	1800	Tractor	99.89	Groundnut	Duraisamy, 1997
9.	V-shaped	900	Tractor	96.00	Onion	Sandeep and Sudhama, 1998
10.	Straight	600	Tractor	94.00	Turmeric	Anon., 2002.
11.	V-shaped	500	Tractor	93.00	Potato and peanut	Ibrahim <i>et al.</i> , 2008
12.	V- shaped	440	Bullock drawn	94.00	Turmeric	Munde <i>et al.</i> , 2009
13.	V- shaped	1000	Tractor	93.64	Sweet potato	Akhir <i>et al.</i> , 2014
14.	Angular tynes	600	Mini-tiller	87.00	Coleus	Younus and Jayan, 2016
15.	Sweep type	450	Bullock drawn	83.00 & 85.00	Turmeric and ginger	Zate <i>et al.</i> , 2018
16.	Inverted V-type	1000	Tractor	81.80	Ginger	
17.	V-shaped	600	Mini-tractor	89.00	Coleus	Md Favazil <i>et al.</i> , 2019

Based on the above review, the three types of blade geometry *viz.*, V-type, crescent and straight edge type blade were selected. Its width, length and thickness were decided as 900 mm, 200 mm and 90 mm according to the bed width, depth of tuber/rhizome and weight of the soil-tuber/rhizome composite.

### **3.5.2 Rake angle of the blade**

The rake angle of the blade ( $\theta$ ) is defined as the angle between the digging direction and a line normal to the blade edge. The rake angle of blade affects the energy consumption for digging operation. The optimum values of rake angle between 10 to 30 deg. as recommended by Pratap and Pandey, (1981) for minimum energy requirement with shallow downward spread of the tubers in lighter soils. A smaller angle of 10 deg. may not penetrate adequately in medium soils to dig out the tuber/rhizome and greater angle of 30deg. may require more traction power for tuber/rhizome crops. Hence, the present investigation was conducted at three levels of rake angles of 15, 20 and 25 deg.

### **3.5.3 Diameter of crank**

The diameter of the crank (D) of the soil separator unit effects on the performance of the machine in terms of conveying efficiency and soil separation index. The three levels of diameter of crank were selected as 40, 60 and 80 mm for experimental trials with the soil separator unit.

### **3.5.4 Speed of crank**

The speed of the crank is another deciding factor to operate the soil separator unit for conveying and separating the soil-tuber/rhizome composite. The three different levels of crank speed were selected as 200, 220 and 240 rpm and analysed using the MSC ADAMS software for velocity and acceleration of the soil separator unit of the harvester.

### **3.5.5 Spring tension**

A spring is defined as an elastic body, whose function is to distort when loaded and to recover its original shape when the load is removed. Tension helical springs exert a force by pulling or stretching them. The load applied is parallel to the axis of spring. Tension helical springs are designed to take tensile loads and they get elongated under the external loads. In helical springs, the wire is subjected to torsional shear stress. Three different levels of spring tensions were selected as

800, 1200 and 1600 N m<sup>-1</sup> for the analysis using ADAMS for finding lifting capacity of the finger assembly of soil separator unit.

### 3.6 DESIGN OF ROOT CROP HARVESTER

Based on soil, crop and machine parameters, mechanical harvesting unit of root crop utilizing P.T.O power of the tractor was developed. The mechanical harvesting of tubers/rhizomes is an operation in which the whole tuber/rhizome has to be dug out from soil with minimum detaching or damaging the tuber/rhizomes from the clump. This was done by loosening the soil with a blade and then the harvested tuber/rhizome along with soil has to be lifted up. Then it is elevated through the soil separator and dropped into the rear of the machine. The main purpose was to design harvester which would require minimum power, low damage to plant material and maximum soil separation at economic cost of operation.

#### 3.6.1 Functional requirements of root crop harvester

Different components of root harvester were designed from the stand point of its functional requirement. The following functional requirements were considered for the design of harvester:

- i. The power unit of the machine able to pull the harvester at the required speed under full load.
- ii. The harvester should dig root crop planted on raised bed of total width 900 mm, covering two to three rows simultaneously in a single operation.
- iii. The digging blade should be able to penetrate to the required depth of around 200 mm to dig out the whole tuber/rhizome clump.
- iv. The dug out tuber/rhizome should pass through the soil separator unit. The soil separator should transmit the tuber/rhizomes and allow the loose soil to fall down through the rods of the soil separator unit.
- v. The soil separator unit of harvester should place tuber/rhizome open on the soil surface at the rear of the harvester, which could be picked up manually with minimum efforts and in minimum time.

- vi. Damage to tuber/rhizome during harvesting operation *i.e.* cut, crush and bruise should be as low as possible.
- vii. It should be operated by a tractor of 35 to 60 hp range, being the common size of tractor available on Indian farm.

### 3.6.2 Selection of prime mover

To select the suitable prime mover, the total power required for operation of the harvester should be known. The total power required is the sum of power required for digging the tuber/rhizome and dropping it back on soil separator unit and power required for pulling the machine. The prime mover was also selected in such a way that the maximum number of farmers be benefited by using the root crop harvester. It is evident that the increase of tractor population is healthier than the power tiller growth and also the ideal power required for the root crop harvesting machine is higher than the power range of walking type tractors. Hence, it was decided to design the proposed machine for tractor, which could be useful to the farming community.

#### 3.6.2.1 Power required for digging soil and clump

The total width of raised bed is 900 mm and it covers two to three rows of planting tuber/rhizomes with a spacing between the crop is 300 x 300 x 300 mm. Hence, the width of cut for a single blade for two to three rows over a total width of 900 mm was selected. The maximum depth of operation required is 200 mm

$$\begin{aligned} \text{Area of cross section of soil dugout by blade} &= \text{depth} \times \text{width} \quad \dots (3.13) \\ &= 0.20 \times 0.9 = 0.18 \text{ m}^2 \end{aligned}$$

The maximum unit draft of the soil =  $0.103 \times 10^6 \text{ N m}^{-2}$  (Smith, 1968)

Since the harvester was operated in the soil which is relatively loose compared to un ploughed land, the unit draft is taken as 85 per cent of the assumed value.

$$\text{Therefore, unit draft} = 0.103 \times 10^6 \times 0.85 = 87550 \text{ N m}^{-2}$$

$$\text{Soil resistance for cutting} = \text{unit draft} \times \text{cross section area of soil cut} \quad \dots (3.14)$$

$$= 87550 \times 0.18 = 15759 \text{ N}$$

Maximum forward speed of tractor =  $0.833 \text{ ms}^{-1}$  ( $3.0 \text{ kmh}^{-1}$ ) (Khurana *et al.*, 2012)

$$\text{Power required} = \text{Draft} \times \text{speed} \quad \dots (3.15)$$

$$= 15759 \times 0.833 = 13127 \text{ W} = 13.13 \text{ kW}$$

### 3.6.2.2 Determination of power for pulling harvester

Total weight of the harvester with hitch point = 2940 N

Force required to pull the unit,  $F = \mu R$

Where,

$\mu$  = Coefficient of friction

$R$  = Weight of the unit, N

Coefficient of friction was taken as 0.8 (Kepner *et al.*, 2005)

Power required for pulling the machine = force  $\times$  speed

$$= 2352 \times 0.833 = 1959.216 \text{ W} = 1.20 \text{ kW}$$

### 3.6.2.3 Power required for soil separator unit

Volume of soil cut = Length of cut  $\times$  speed  $\times$  depth of operation

$$= 0.9 \times 0.833 \times 0.2 = 0.149 \text{ m}^3$$

Mass of soil = Volume of soil cut  $\times$  Bulk density of soil

$$= 0.149 \times 1450 = 216 \text{ kg}$$

$$= 216 \times 9.81 = 2119.45 \text{ N}$$

PTO Power =  $2119.45 \times 1.25 = 2649.31 \text{ W} = 2.65 \text{ kW}$

Slip factor = 0.25

Therefore, power required from PTO =  $2.65 \times 1.25 = 3.31$  kW

Total power requirement of the unit = Power required for digging soil and clump(a) + Power required for pulling unit(b) + Power required for soil separator unit (c) ... (3.16)

$$= 13.13 + 1.20 + 3.31 = 17.64 \text{ kW}$$

Out of which a and b are from tractor drawbar and c is from P.T.O

The total power required for the root crop harvester was 17.64 kW, but the commercially available was above 28 kW. Therefore, the power required to operate the machine will be adequately provided from the drawbar and PTO of a 28 kW tractor.

#### **3.6.2.4 Determination of draft on digging unit**

From the designer point of view, the working depth of digging unit is an important parameter as it directly affects the power requirement of a root crop harvester. The working depth of digging blade is mainly dependent on the depth of tuber/rhizome in the soil. The study of crop properties of rhizomes/tubers showed that the depth of tuber/rhizome ranged between 120-200 mm with reference value of 200 mm. Considering the probable variation in depth of tuber/rhizome on different varieties of soil and to harvest them without damage, optimum depth of operation was selected as 200 mm.

The draft of the blade was calculated using the general soil mechanics equation for a blade deforming the soil in two dimensions (Hettiarachi *et al.*, 1966) given by equation 3.17. It takes into account different soil properties and tool geometry parameters as following:

$$P_p = \gamma Z_1^2 N \gamma + CZ_1 N c + CaZ_1 N c a + qZ_1 N q \quad \dots \quad (3.17)$$

Where,

$P_p$  = Passive resistance of soil acting at an angle of soil-metal friction with the normal to interface, kg per meter width,



$\gamma$  = Bulk density of soil,  $\text{kg m}^{-3}$

$Z_1$  = Depth of operation, m,

$C$  = Cohesion of soil,  $\text{kg m}^{-2}$ ,

$C_a$  = Soil-interaction adhesion,  $\text{kg m}^{-2}$ , and

$q$  = Surcharge pressure on soil from surface above the failure plane,  $\text{kg m}^{-2}$ .

$N_\gamma$ ,  $N_c$ ,  $N_q$  and  $N_{ca}$  are dimensionless N- factors, which describe the shape of soil failure surface and this is a function of angle of shearing resistance of soil ( $\Phi$ ), angle of soil metal friction ( $\delta$ ) and geometry of loaded interface *i.e.* rake angle ( $\alpha$ ).

For determination of draft, the following assumptions were made (Shirwal, 2010):

- i. Soil is homogenous and isotropic,
- ii. Average bulk density of soil is  $1750 \text{ kg.m}^{-3}$ ,
- iii. Soil is in friable range of moisture content with cohesion ( $C$ ) of  $710 \text{ kg m}^{-2}$ , angle of internal friction ( $\Phi$ ) of  $25^\circ$  and angle of soil metal friction ( $\delta$ ) of  $20^\circ$  for bulk density of  $1750 \text{ kg m}^{-3}$ ,
- iv. Adhesion of soil is zero *i.e.*  $C_a = 0$ , assuming soil-metal friction to be zero as soil scouring over the blade,
- v. The surcharge in front of the soil above soil failure zone is negligible, *i.e.*  $q = 0$ ,
- vi. Usual variations in rake angle of the digging blade range between 15 to 25 deg.in the experiments. A rake angle of 20 deg. was considered for determination of expected draft, as 20 deg. was the mean value of rake angle selected for experimentation.

Based on the above assumptions, the Equation 3.16 could be reduced as follows

$$P_p = \gamma Z_1 N_\gamma + CZ_1 N_c \quad \dots (3.18)$$

The relationship between the N-factor and the rake angle at different angle of internal friction for a perfectly smooth ( $\delta=0$ ) and perfectly rough ( $\delta = \Phi$ ) interface

was taken from graph (Hettiarachi *et al.*, 1966). The values of N-factor for intermediate degree of roughness of the interface could be interpolated using the following equation:

$$N_{\delta} = N_{\delta=0} \left[ \frac{N_{\delta=\Phi} - N_{\delta=0}}{N_{\delta=\Phi} - N_{\delta=0}} \right]^{\frac{\delta}{\Phi}} \quad \dots (3.19)$$

Where,

- $N$  = Required value of the appropriate N-factors ( $N_{\delta}$  or  $N_c$ )  
 $N_{\delta=0}$  and  $N_{\delta=\Phi}$  = Corresponding value of the N-factor at  $\delta = 0$  and  $\delta = \Phi$ , respectively, obtained from the appropriate chart.

Following values for the different parameters in the Equation 3.16 were used for determination of passive resistance of the blade:

$$\gamma = 1750 \text{ kg.m}^{-3}, C = 910 \text{ kg m}^{-2}, \Phi = 25.58^{\circ}, \delta = 25.31^{\circ}, \alpha = 15^{\circ}, Z_1 = 0.2 \text{ m}$$

Using the relationship, the value of N-factors were calculated as follows:

$$N_{\gamma} = 1.83, N_c = 1.68$$

Substituting the values of  $N_{\gamma}$  and  $N_c$ , in the Equation 3.19 the passive resistance ( $P_p$ ) per unit width of the blade was obtained as:

$$P_p = 1750 \times (0.2)^2 \times 1.83 + 910 \times 0.2 \times 1.68 = 344.70 \text{ kg m}^{-1}$$

Therefore,  $P_p$  for an effective width of cut of 0.90 m of blade is  $344.70 \text{ kg m}^{-1}$

The passive resistance  $P_p$  was acting at an angle of friction ( $\delta$ ) with normal to the interface, hence the component parallel to the blade face ( $P_{p1}$ ) is given by:

$$P_{p1} = 344.70 \times \cos 70^{\circ} = 117.89 \text{ kg m}^{-1}$$

The component perpendicular to the blade face ( $P_{p2}$ ) is given by

$$P_{p2} = 344.70 \times \cos 20^{\circ} = 323.91 \text{ kg m}^{-1}$$

The obtained value of  $P_{p1}$  and  $P_{p2}$  were used to determine the bending moment of the digger blade.

The draft of the blade was calculated 344.70 kg using the general soil mechanics equation for a blade deforming the soil in two dimensions (Hettiarachi *et al.*, 1966) given by equation 3.17. Usual variations in rake angle of the digging unit ranged between 15 to 25 deg. A rake angle of 20 deg. was considered for determination of expected draft.

### 3.6.3 Design of digging unit

Digger blade would execute initial digging of tuber/rhizome plants. The width of digger blade is an important factor, as it would cover all plant rows in a bed without damaging standing crop. Therefore, it was decided on the basis of the width of the bed that the root crop was grown in two to three rows. The thickness of the blade was designed on the basis of load acting on it. This could be theoretically determined by analysing various different forces acting on the blade.

$P_{p2}$  is perpendicular component of  $P_{p1}$  and would cause bending moment whereas  $P_{p1}$  is the horizontal component that would induce direct stress on the blade. The force would act at the centre of resistance of the blade. It was assumed that average soil resistance of the blade acts at a distance of  $0.2 z_1$ , measured from the cutting edge (Bernacki, 1972) as shown in Fig 3.3.

The centre of resistance was at a distance of 50 mm from the cutting edge on central axis of the width of blade. The blade was supported on nuts and bolts at a distance of 200 mm from each side of the cutting edge. Therefore, the distance between the centre of resistance and point of support could be determined by:

$$250 - 50 = 200 \text{ mm}$$

Therefore, the bending moment (B.M.) due to  $P_{p2}$  is:

$$\text{B.M.} = 323.91 \times 200 = 64782 \text{ kg mm}$$

Bending stress ( $\sigma_b$ ) is represented by :

$$\sigma_b = \frac{\text{B.M.}}{\frac{1}{6}bt^2} \quad \dots (3.20)$$



### 3.6.3.1 Design of power transmission system

The soil separator unit was provided motion to remove/separate the tubers/rhizomes through proper power transmission system. The power transmission system has been made at three stages, first from P.T.O to machine gear box, where the power is transmitted through propeller shaft, in second stage, from which power is transmitted to cranks through the side shafts of the gear and third stage the power is transmitted from cranks to soil separator unit by the connecting rods and rockers.

### 3.6.3.2 Design of crank

In this mechanism, the rotary motion of crank is converted into reciprocating motion of the soil separator unit. The crank radius was decided by the following formula (Ballaney, 1990).

$$X = r [(1 - \cos\theta) + n - (n^2 - \sin^2\theta)^{1/2}] \quad \dots (3.25)$$

Where,

- X = Amplitude of oscillation of unit, 16 cm
- r = Crank radius, cm
- $\theta$  = Angular displacement of crank
- n =  $l/r$
- l = connecting rod, 43 cm

For maximum displacement of the unit,  $\theta = 180^\circ$  hence  $\cos \theta = -1$  and  $\sin \theta = 0$

$$X = r[1 - (-1) + \frac{43}{r} - ((\frac{43}{r})^2 - 0)^{\frac{1}{2}}]$$

$$X = r[2 + \frac{43}{r} - ((\frac{43}{r})^2)^{\frac{1}{2}}] = r[2 + \frac{43}{r} - \frac{43}{r}]$$

$$16 = r [2]$$

$$r = 8 \text{ cm}$$

For the displacement of 160 mm of the unit, the radius of crank was decided as 80 mm.

The motion for soil separator unit was provided by the power transmission unit, in which shaft, crank, connecting rod and rockers are the main parts. The diameter and length of side shafts of the machine gear box was 45 mm and 300 mm respectively having 10 splines on it. The power from the shaft was supplied to a crank having diameter 120 mm. The number of revolutions of crank was dependent up on the PTO speed of the tractor. This rotary motion was converted in to reciprocatory motion with the help of connecting rod. The connecting rod was made of M.S. rod of 430 mm length and 40 mm diameter. One end of connecting rod was attached to crank with help of ball bearing having diameter 45 mm and the other end was attached to the rocker, made of M.S flat. The number of revolutions made by the shaft is equal to number of reciprocating motions of soil separator unit. The length of oscillation of the unit was dependent on the diameter of the crank. The displacement of unit was zero when it was set at ( $0^\circ$ ) of the crank, and displacement of 80 mm and 160 mm respectively was observed when it was set at 180 and 360 deg.

### ***3.6.3.3 Design of spring tension***

The spring tension is calculated using the equation (Ballaney, 1990).

$$T = 2\pi\sqrt{\frac{m}{k}} \quad \dots(3.26)$$

Where,

- T = oscillating frequency,  $s^{-1}$
- m = mass of soil-crop, kg
- k = spring constant,

$$k = \frac{4\pi^2 150}{2^2} = 1480.44$$

Four springs were selected for operating lifting mechanism of unit with spring tension of 400 N per spring.

### 3.6.3.4 Design of spring

For design of spring, the outside diameter, length of spring and deflection were taken as 25 mm, 150 mm and 15 mm respectively. Applied load was 2000 N and four springs (500 N each) were selected for the lifting of finger assembly in soil separator unit. Spring was made of SS 302 and designed spring as shown in the Fig.3.4. Modulus of rigidity and density of SS Wire 302 was found out as 73000 Pa and 7800 kg m<sup>-3</sup> respectively, from design data. Spring Index is the ratio of the mean diameter of the coil to the diameter of the wire. Mean diameter and inside diameter of spring were assumed as 25 and 21 mm.

Total number of active coils = 16

$$\begin{aligned}\text{Spring Index} &= \frac{D}{d} \\ &= 5.67 \text{ and selected as } 8\end{aligned}$$

According to Wahl, Maximum shear stress is given by,

Shear stress factor,

$$K = 1 + \frac{1}{2C} = 1 + \frac{1}{2 \times 5.67} = 1.269$$

Maximum shear stress,

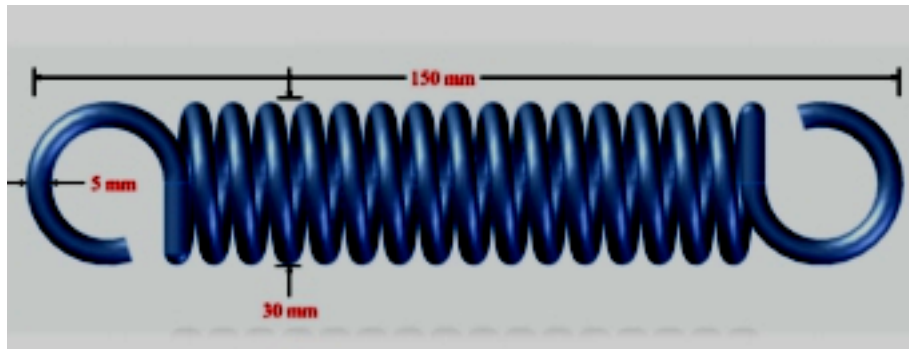
$$\begin{aligned}\tau_{\max} &= K \frac{8WD}{\pi d^3} = 1.062 \times \frac{8 \times 500 \times 30}{\pi 21^3} \\ &= 452.28 \text{ MPa}\end{aligned}$$

Spring Stiffness/Spring Constant: Force required to produce unit deflection in the spring.

Deflection of helical spring

$$\delta = \frac{8FD^3N}{Gd^4} = \frac{8 \times 500 \times 25^3 \times 16}{73000 \times 21^4}$$

Total spring deflection	=	27 mm
Spring deflection	=	15.1
Initial tension	=	91.70 MPa
Allowable torsional stress	=	483.33 MPa
Full load stress	=	452.28 MPa



**Fig.3.4. Spring for finger assembly**

### **3.6.4 Design of soil separator unit**

The design of the soil separator unit was based on its functional requirements. The width of soil separator unit was selected as 1000 mm based on the tread width of the tractor. The soil separator unit consisted of a frame having 1000 x 500 mm as length and width. The soil separator unit consisted of fingers made of MS rods of  $\text{Ø}10$  and 500 mm length. A set of rods at the rear of the blade lifts the harvested tuber/rhizome to drop it backward. The numbers of rods used were 10, which were spaced at 50 mm.

Crank rocker mechanism is used in the soil separator unit. Thus, of the 4 links, link 1(Crank) receives the rotary drive from the side shaft of the gear box. As the link 1 rotates, the link 2 (Connecting rod) moves up and down motion. This movement in turn causes oscillating motion to the link 3 (Rocker). As the link 3 is connected to link 4 (Rocker extension of unit),the crank rocker assembly generates a reciprocating motion to the linkage 4. Hence a crank rocker mechanism is developed and drives the soil separator unit. Four springs were attached to the



frame and finger assembly of soil separator unit to provide up and down motion of lifting rods.

In general, the crank-rocker mechanism is used to transform rotational motion into oscillating motion of the rocker and also to transmit the desired torque from a given input torque. The mechanism has advantages of generating complex motion from a simple input rotational motion by using four bar linkages. The performance of a crank rocker mechanism can be defined as the effective transmission of motion and force from the crank input-link to the rocker output-link (Ballaney, 1990).

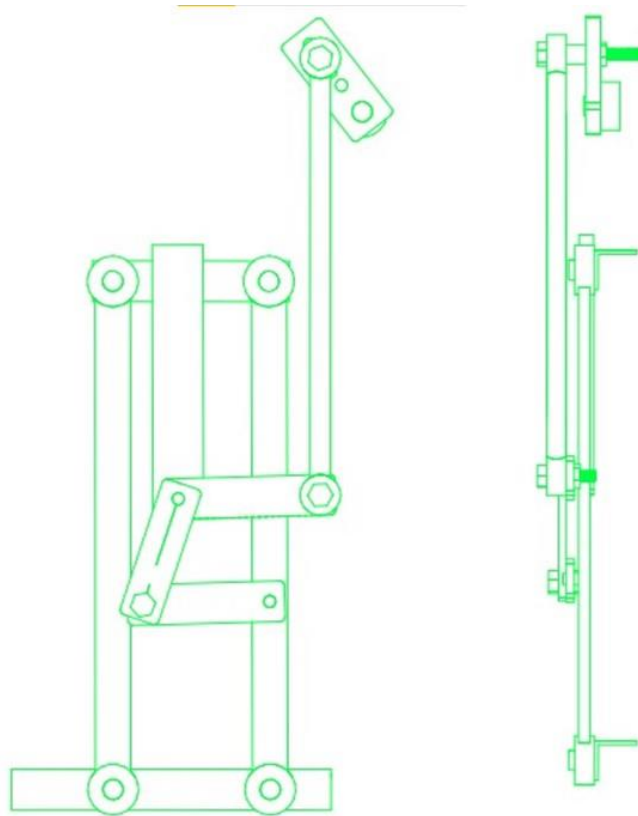
The offset crank drives connected to the output shafts of the gear box together with the connecting rods produced the oscillatory motion. The rotary motion of the gear shaft was converted to the oscillatory motion of the connecting rods. The connecting rods transferred this motion to the finger rods assembly of the soil separator unit.

#### ***3.6.4.1 Kinematics analysis of the mechanism***

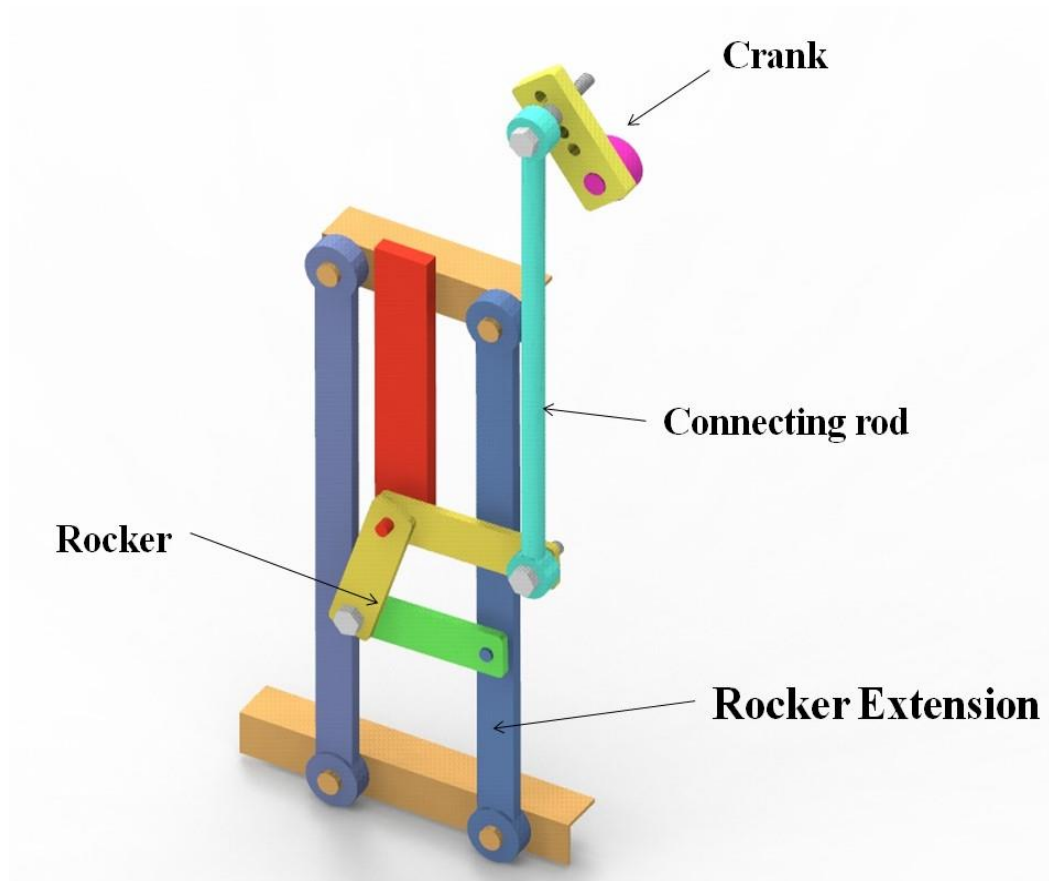
It is the study of the geometry of the motion. Kinematic analysis involves determination of position, displacement, rotation speed, velocity and acceleration of a mechanism. Computer software MSC ADAMS (Automatic Dynamic Analysis of Mechanical Systems) is one of the most widely used multi-function computing software. The program allows to create dynamic, kinematic and static analysis of the proposed mechanical systems and helps to optimize and improve its designs. It helps in simulations of mechanical systems consisting of rigid and flexible bodies connected by different types of kinematic links and joints (Darina *et al.* 2014). The computing software ADAMS was used for modelling, analysing and optimize the mechanical, *i.e.* multi-body systems. The isometric and orthographic views of crank rocker mechanisms shown in Fig.3.5 and 3.6. The analysis of 4 bar link mechanism (Crank rocker mechanism) was done using ADAMS software with and without constraints as shown Fig 3.7 and 3.8. The displacement analysis of the model with different crank angles were carried out for 0 to 360 deg. angles of crank of 80 mm diameter. The displacement of mechanism varied from 25 to 160 mm

with 0 to 360 deg. and maximum displacement was observed at the crank angle 240 deg. for 80 mm diameter as shown in the Fig 3.9.

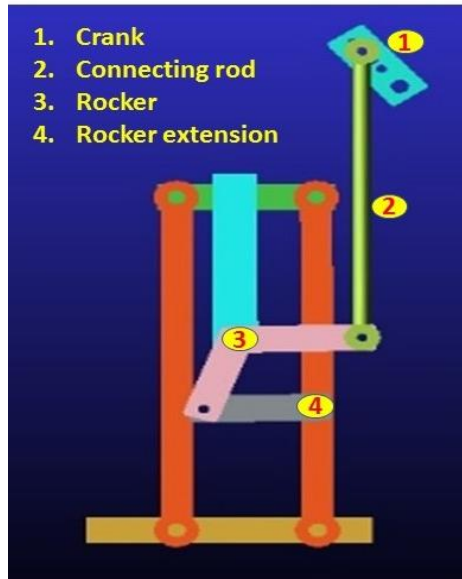
Velocity analysis of the model w.r.t crank speeds at 200, 220 and 240 rpm were also done using ADAMS. The variation of velocity and acceleration of the mechanism were shown in the Fig. 3.10 and 3.11. The velocity of the model with respect to 200, 220 and 240 rpm were observed as 1.0-1.5, 1.1-1.9 and 1.2-1.95 m s<sup>-1</sup> respectively. The acceleration of the model with respect to 200, 220 and 240 rpm were observed as -20 to 40, -25 to 45 and -30 to 50 m s<sup>-2</sup> respectively as in shown Fig 3.8 to 3.9. The optimized values for the prototype of mechanism were found out as 80 mm diameter of crank and speed of crank 220 rpm.



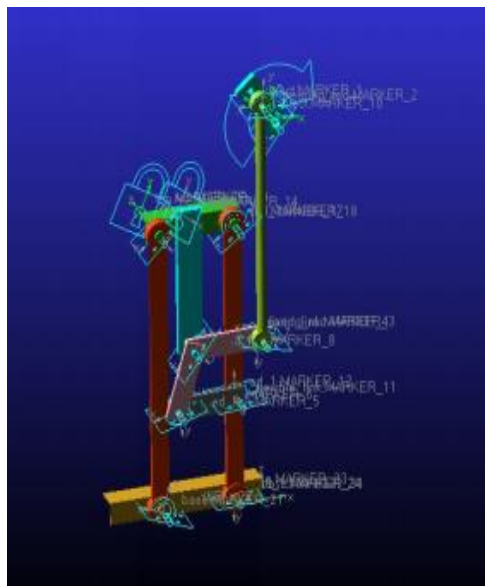
**Fig.3.5 Orthographic view of crank rocker mechanism**



**Fig.3.6 Isometric view of Crank rocker mechanism**



**Fig. 3.7 Crank rocker mechanism without constraints**



**Fig. 3.8 Crank rocker mechanism with constraints**

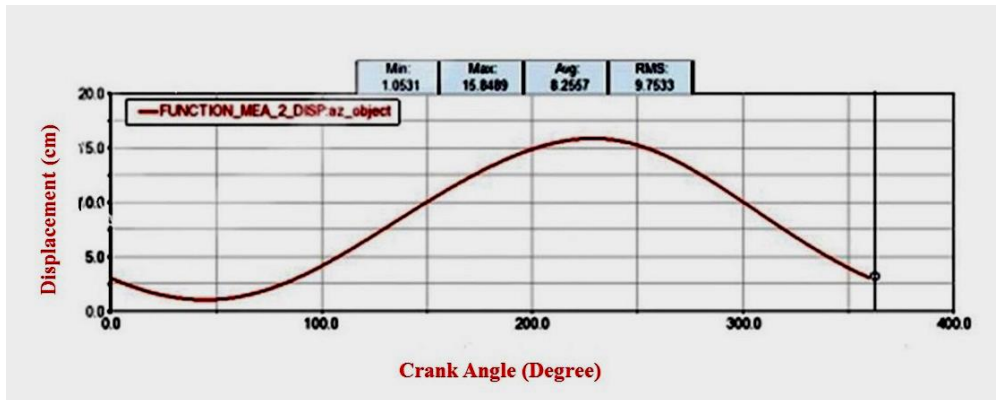


Fig.3.9 Displacement diagram of the model w.r.t crank angle

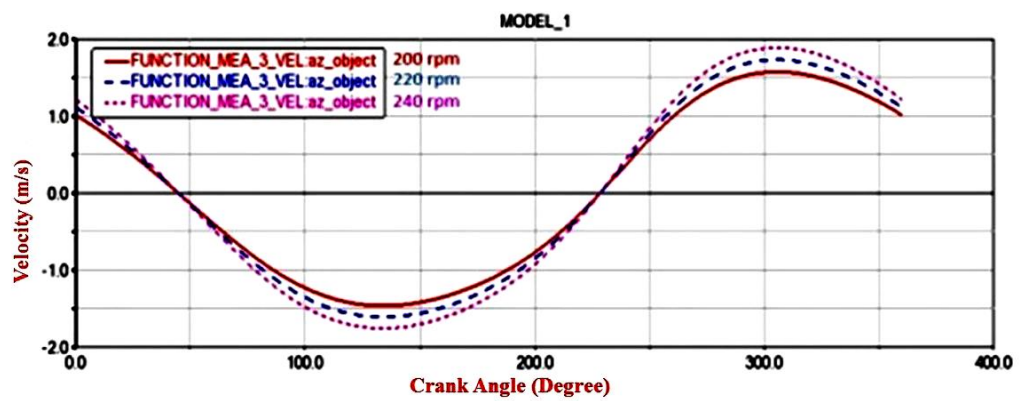


Fig.3.10 Velocity diagram w.r.t crank angles for 200,220 and 240 rpm

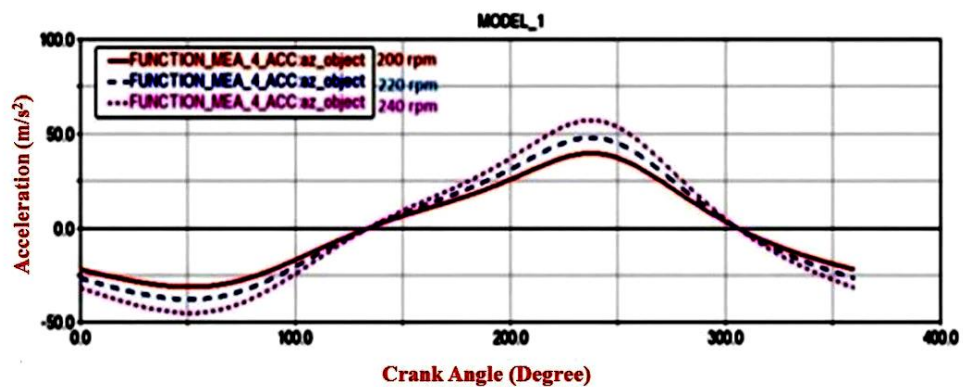


Fig.3.11 Acceleration diagram of the model w.r.t crank angles at 200, 220 and 240 rpm

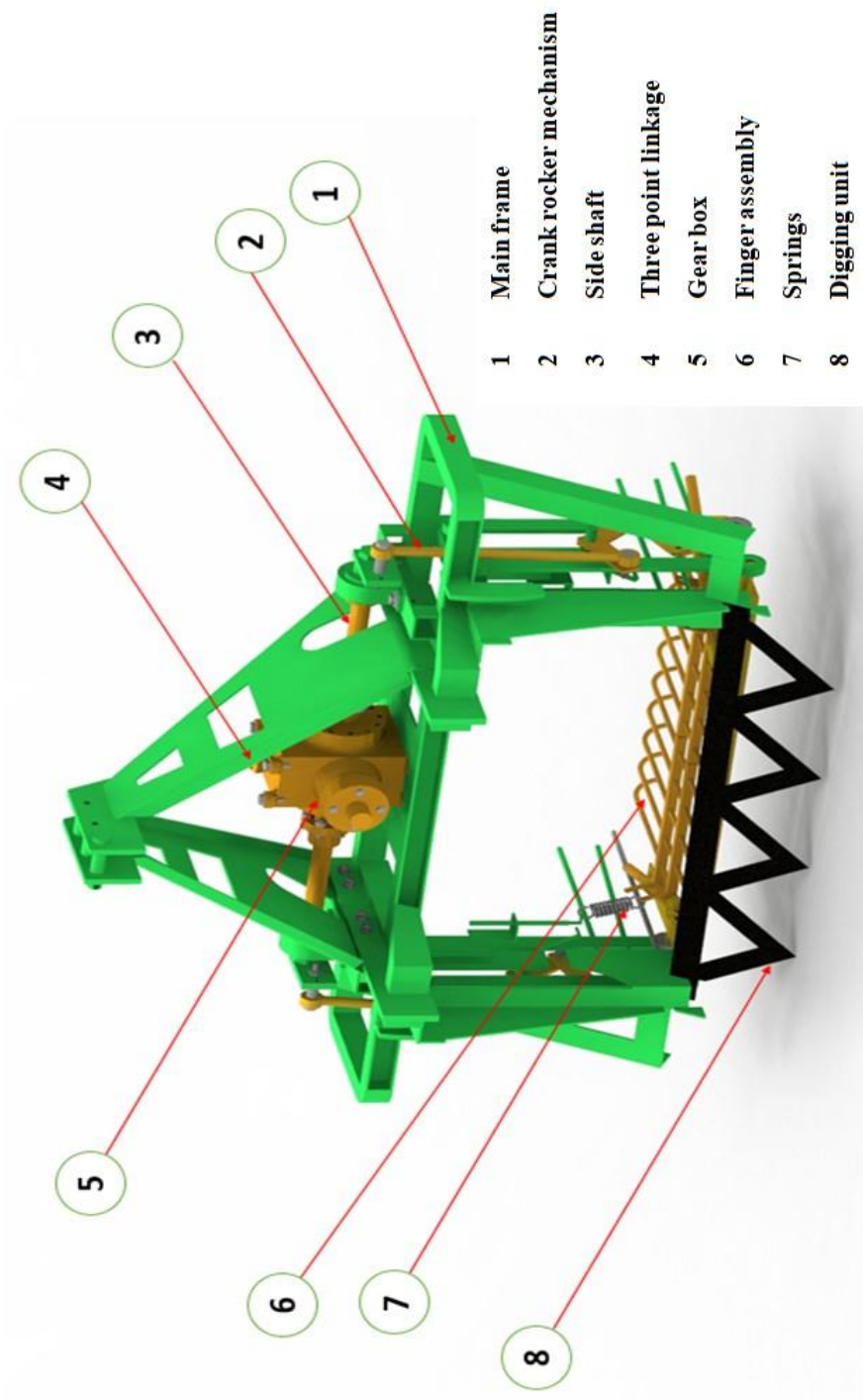
### **3.6.5 Determination of throat clearance**

The throat of the harvester was determined with reference to the flow of material on soil separator unit. The width of the throat was limited to 1 m due to the selected blade size. The height was determined on the basis of height of root crop leaves. It was done so that, no damage is caused during the operation and to the material handled by the digger. The maximum depth of the digger was selected as 200 mm based on the distribution of tuber/rhizome in the soil.

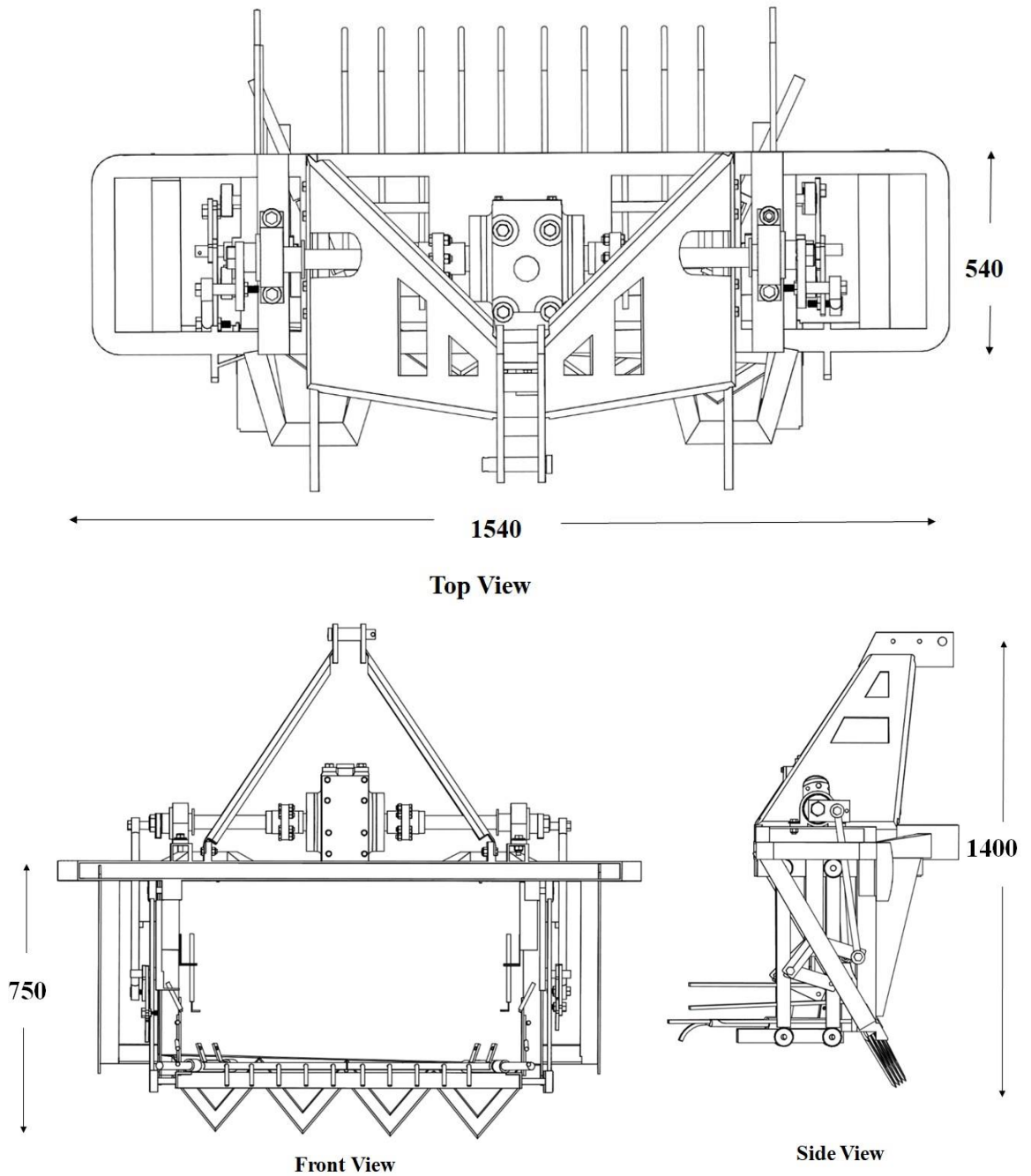
Considering the average height of the root plant as 300 mm and depth of operation as 200 mm, the total height of the soil-rhizome plant was calculated as 500 mm. After the lifting of soil-rhizome, the volume would increase by 1.5 times of the original volume. The other materials like weed may also pass through the throat and therefore, a clearance of 100 mm was provided in addition to the height of material. Hence, the total throat height of the digger was decided as 600 mm.

### **3.7 DEVELOPMENT OF ROOT CROP HARVESTER**

The prototype of the tractor drawn root crop harvester consists of main frame, power transmission system, digging and soil separator units. The isometric and orthographic views of tractor drawn root crop harvester is shown in Fig.3.12 and Fig.13



**Fig.3.12 Isometric view of root crop harvester**



All dimensions in mm

Fig.3.13 Orthographic view of root crop harvester



### **3.7.1 Main frame**

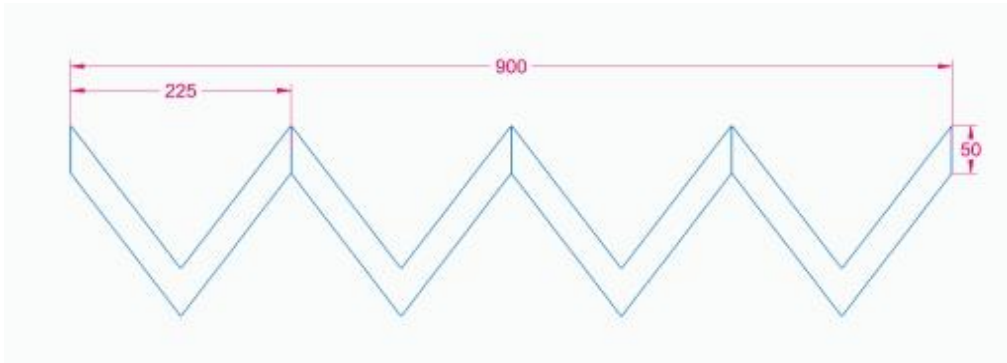
The main frame was designed by considering the height of plant, bed width. It was made of MS channel for mounting power transmission unit, digging and soil separator units. The overall dimension of the main frame is 1540 x 540 mm.

### **3.7.2 Power transmission system**

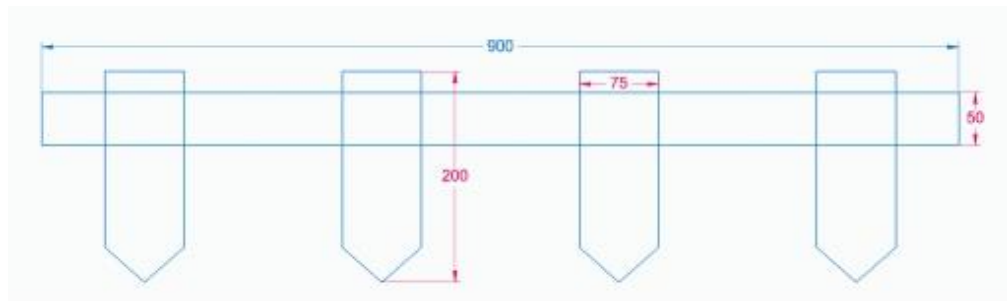
The power transmission system was made in two stages, first from tractor P.T.O to the machine gear box and from there to the crank by side shafts, again the drive is transferred to the soil separator unit through two four barlinks (Crank rocker mechanism). The speed of P.T.O shaft is  $540 \pm 10$ . A universal coupling was used to transfer the rotation to input shaft of gear box, of which the gear ratio was provided as 1:2.2 ratio. Two side shafts were connected to gear box to get a rotational speed of 220 rpm to the crank of the soil separator unit through a two four bar mechanism (Crank rocker).

### **3.7.3 Digging unit**

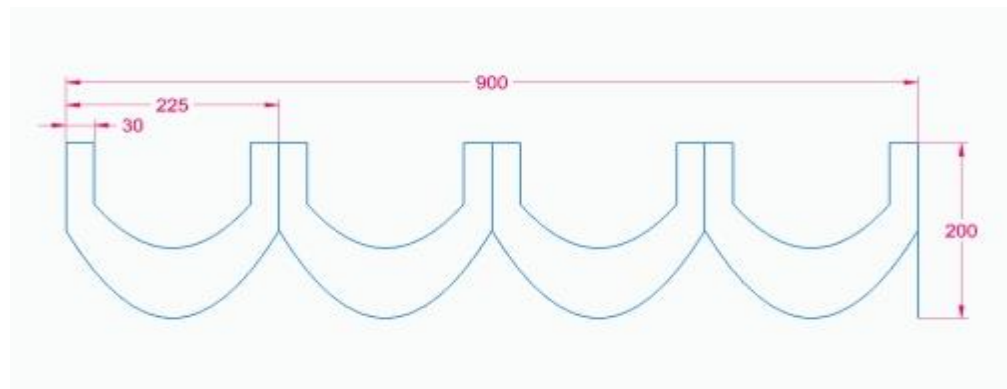
The digging unit is to dig out the tuber/rhizome from the soil planted at a depth ranging from 15 to 20 cm. The digging unit was made of M.S material. The length, width and thickness of the blade were taken as 900, 200 mm and 10 mm respectively. The blade was fitted at the fore front of the soil separator unit at angles varied from 15 to 25 deg. with the horizontal. Different types of digging blade are shown in Fig. 3.12 and Plate 3.4.



(a) V-type blade



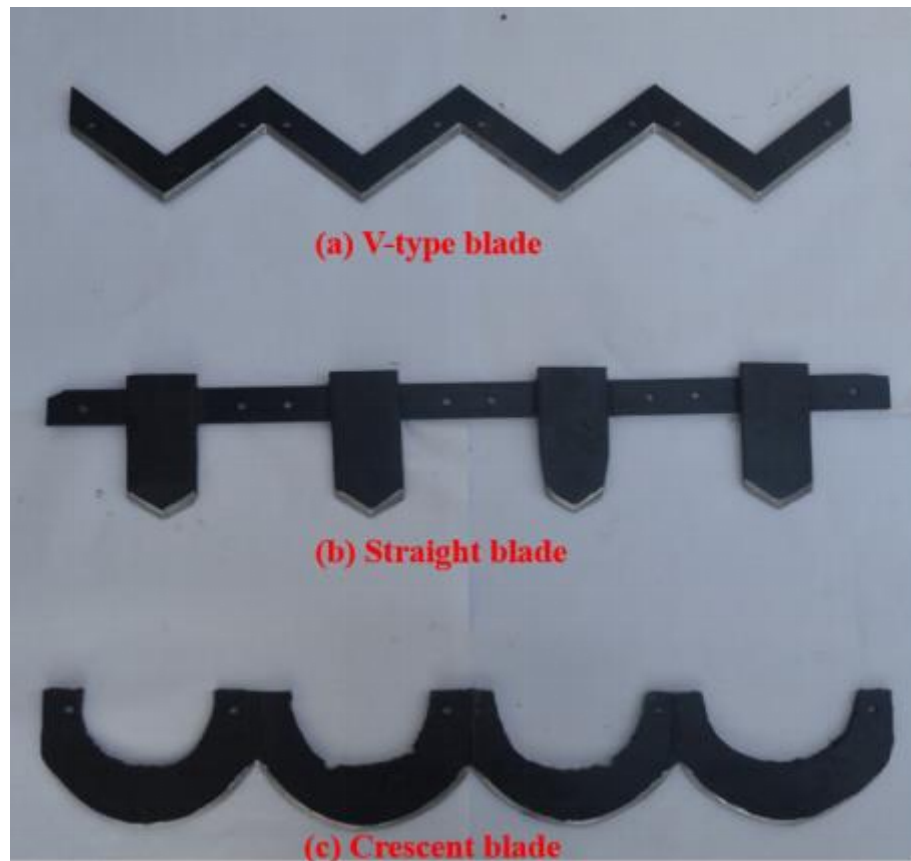
(b) Straight edge type blade



All dimensions in mm

(c) Crescent blade

Fig.3.14 Types of digging unit



**Plate. 3.4 Types of digging unit**

### **3.7.4 Soil separator unit**

The soil separator unit consisted of soil separator of dimension 1000 x 600 mm. The soil separator consists of oscillating sets of fingers, crank rocker mechanism and a spring. Fingers are made of Ø10 MS rods and 600 mm length.

The two sets of oscillating finger rods, 5 fingers each, constituted the moving part of the soil separator unit. Each set finger rods connected to main frame with help of four springs which helps in the lifting movement. The oscillation was obtained from the drive unit. The fingers were drilled through square rods and welded in place. The gap between rods of the unit kept in the range such that the root crops should not fall from the gap. For free and efficient dropping of soil mass from soil separator unit, the rods spacing was kept as 50 mm and for early dropping of tubers/rhizomes from the unit, its length was kept about twice the average length of tuber/rhizome spread with plant cutting. Thus, the length of soil separator unit was kept 60 cm. It was bent at the rear end to drop the soil lump on to the bed

without much scattering. The basic requirement of the soil separator unit is to loosen the soil from the dug crop by providing oscillations in the unit. The oscillating unit were provided immediate after the frame of the digging unit. The number of oscillations of the soil separator can be increased by increasing the peripheral speed which can be regulated by the P.T.O speed of the tractor.



**Plate.3.5 Prototype of the root crop harvester**



**Plate.3.6 Prototype root crop harvester attached with tractor**

### 3.8 TESTING AND OPTIMIZATION OF ROOT CROP HARVESTER

The operational parameters of the digging and soil separator unit of the root crop harvester were separately evaluated in the field. The operational parameters of the digging unit were evaluated in terms of draft, digging efficiency, percent damage and fuel consumption for three different types of blades at different rake angles and forward speeds. The selected rake angles are 15, 20 and 25 deg. respectively and forward speeds are 1.5, 2.0 and 2.5 km h<sup>-1</sup> respectively. Similarly, the performance of the soil separator unit was evaluated in terms of conveying efficiency and soil separation index for three different crank diameters of 40, 60 and 80 mm and spring tensions of 800, 1200 and 1600 N m<sup>-1</sup>. Tests were conducted in research stations of KAU and farmer's fields. The moisture content of soil was maintained at 15 per cent (d.b) by allowing the field to dry after rainfall. Each experiment was repeated three times. The experiments were conducted for the treatment combinations (81) as shown in Table. 3.2





**Plate 3.7 View of root crop harvester in field**

**Table 3.2 Factors selected for the experiment**

	Digging unit		Soil separator unit	
Type of blade	Rake angle, deg.	Forward speed, km h <sup>-1</sup>	Diameter of crank, mm	Spring tension, N m <sup>-1</sup>
Straight edge	15	1.5	40	800
V-type	20	2.0	60	1200
Crescent	25	2.5	80	1600
Replications = 3			Replications = 3	
Total number of experiments	3x3x3x3 = 81		Total number of experiments = 3x3x3 = 27	

### 3.8.1. Draft measurement

Draft was measured using a dynamometer (Plate 3.8). The harvester was mounted on tractor A and was towed by another tractor (B). A dynamometer was connected in between tractors and the draft was measured by engaging tractor A in

neutral gear condition and harvester was in operating condition. Keeping the harvester in lift position after the tractor is allowed to move further. The difference between two draft readings were measured and recorded.

Draft power requirement for the operation of harvester was calculated by the following formula:

$$\text{Power(kW)} = \frac{\text{Draft(kN)} \times \text{Speed(km h}^{-1}\text{)}}{3.6} \quad \dots\dots(3.27)$$



**Plate. 3.8 Measurement of draft**

### 3.8.2 Digging efficiency

Digging efficiency was calculated using the following formula:

$$\text{Digging Efficiency(Percent)} = \frac{A}{A+B} \times 100 \quad \dots\dots(3.28)$$

Where,

A = Mass of Tuber/rhizome dugout by harvester in unit area, kg

B = Mass of Tuber/rhizome left in soil after harvesting in unit area, kg

After each test run a sample area of 10 m x 10 m was demarcated at three places randomly. The sampling area was thoroughly cleaned and the weight of

tuber/rhizome, both exposed and covered with soil was recorded. The result was presented on percentage basis. A higher percentage of tuber/rhizome plants harvested indicates better performance of harvester (Wajire *et al.*, 2018).

### 3.8.3 Per cent damage

During harvesting operation, different types of damages occur to tuber/rhizome in the form of cut, crush, sliced or bruised. Improper depth of operation during harvesting was one of the main cause of cutting and slicing of tuber/rhizome. Bruises were caused due friction of the tuber/rhizome plant with metal parts of the harvester and also due to friction between soil particles while flow of plant-soil mass from blade to soil separator unit. Harvested tuber/rhizome per unit run were examined; damaged rhizomes were separated from the stack and measured mass of the tuber/rhizome was measured (Wajire *et al.*, 2018). Damage percentage was calculated as:

$$\text{Damage (Percent)} = \frac{C}{A + B} \times 100 \quad \dots(3.29)$$

Where,

- A = Mass of tuber/ rhizome dugout by harvester, kg
- B = Mass of tuber/rhizome left in soil after harvesting, kg
- C = Mass of damaged tuber/rhizome, kg

### 3.8.4 Fuel consumption

The top fill method was used for measuring fuel consumption. The measurement of fuel consumption of tractor was carried out by filling up the fuel tank before starting each trial and after finishing the trial again tank was refilled. Amount of refilling after the operation was measured which was the fuel consumption for digging operation and it was expressed as liter per hour.

### 3.8.5 Soil separation index

It is the ratio of the difference of soil tuber/rhizome ratio before and after digging. It is given by the formula (Khura *et al.*, 2011).



$$I_s = 1 - \frac{r_a}{r_b} \quad \dots(3.30)$$

Where,

- $I_s$  = Soil separation index  
 $r_a$  = Soil-tuber/rhizome ratio after digging, kg and  
 $r_b$  = Soil- tuber/rhizome ratio before digging, kg

### 3.8.6 Conveying efficiency

The root crop harvester was run for a travel of 10 m and the observations were recorded. The observations recorded were the weight of tuber/rhizome plants picked and conveyed and the weight of plants not picked by the unit. The conveying efficiency was calculated by the following formula,

$$\eta_{pc} = \frac{W_1 + W_2}{W_1 + W_2 + W_3} \times 100 \quad \dots (3.31)$$

Where,

- $\eta_{pc}$  = Conveying efficiency, per cent  
 $W_1$  = Weight of tuber/rhizome delivered by the soil separator in ten meter run, kg  
 $W_2$  = Weight of tuber/rhizome remaining on the soil separator in ten meter run, kg  
 $W_3$  = Weight of unpicked and dropped plants by the soil separator in ten meter run, kg

Each test was replicated three times. The experiment was repeated for the levels of variables and average was calculated.

## 3.9 OPTIMIZATION OF OPERATIONAL PARAMETERS

The operational parameters of the harvester were separately optimized for digging and soil separator unit. The interaction effects of the independent variables such as type of blade, rake angle, forward speed and dependent variables such as draft, digging efficiency, per cent of damage and fuel consumption were studied using three factorial designs and “Design-Expert” version 12.0.4 was used for statistical analysis. The desirability index was used to found out the best optimum values separately for digger and soil separator units.

Desirability index is an objective function that ranges from zero outside of the limits to one at the goal. The numerical optimization finds a point that maximizes the desirability function. The characteristics of a goal may be altered by adjusting the set conditions. For several responses and factors, all goals get combined into one desirability function. The goal of optimization is to find a good set of conditions that will meet all the goals.

### 3.10 PERFORMANCE EVALUATION OF DEVELOPED ROOT CROP HARVESTER

Based on the optimum values of the digging and soil separator units of the harvester the prototype was refined and its performance was evaluated in the KCAET Instructional Farm, RARS Pattambi, State Seed Complex, Munderi and different farmers' fields at Thrissur and Palakkad districts. The engine speed of the tractor was kept constant at 1600 rpm throughout the test and was set at the optimum levels of the operational parameters of the digging and soil separator units. The performance of the tractor mounted root crop harvester was evaluated in terms of digging efficiency (per cent), Per cent damage (per cent), soil separation index (per cent), conveying efficiency (per cent), field efficiency (per cent) and fuel consumption ( $l/h^{-1}$ ) respectively

#### 3.10.1 Theoretical field capacity

The theoretical field capacity of harvester directly effects on the field efficiency of harvester. For calculating theoretical filed capacity, working width and travelling speed were taken into consideration. The theoretical field capacity was computed by using following relationship (Moayad *et al.*, 2014).

Theoretical field capacity in each plot was computed using the following equation

$$TFC = \frac{S \times W}{C_2} \quad \dots(3.32)$$

Where,

$$TFC = \text{Theoretical field capacity, ha h}^{-1}$$

- S = Forward speed, km h<sup>-1</sup>  
W = Working width, m  
C<sub>2</sub> = Conversion factor 10

### 3.10.2 Effective field capacity

The actual output in terms of area covered per hour was expressed as the effective field capacity. The total time taken by digger to finish the operation in each experiment plot was recorded by keeping the working speed and rake angle as constant as possible throughout the work. The effective field capacity was calculated in (ha h<sup>-1</sup>) using the following expression (Moayad *et al.*, 2014) and mean values were reported.

Effective field capacity was calculated as follows

$$EFC = \frac{A}{T} \times C_3 \quad \dots (3.33)$$

Where,

- EFC = effective field capacity, ha h<sup>-1</sup>  
A = plot area, m<sup>2</sup>  
T = time, sec  
C<sub>3</sub> = conversion factor, 0.36

### 3.10.3 Field efficiency

Field efficiency was calculated by using the following formula (Moayad *et al.*, 2014).

$$\text{Field Efficiency} = \frac{EFC}{TFC} \times 100 \quad \dots (3.34)$$

Where,

- EFC = Effective field capacity, ha h<sup>-1</sup>  
TFC = Theoretical field capacity, ha h<sup>-1</sup>

### 3.11 COST ECONOMICS

The economics of the tractor operated root crop harvester will be helpful in decision making for purchasing a root crop harvester for individual farmer to own a machine or its custom hiring. The total cost of the tractor mounted root crop harvester was calculated. Fixed cost depends on the machine whether own use or custom hiring. But variable cost directly depends on the amount of machine used in unit time. The cost of operation includes break-even point and payback period were calculated according to BIS standard IS: 9164-1979. The details of procedure explained in details as follows and calculations are given in Appendix-XIV. The performance was compared with conventional method of harvesting in terms of savings in cost and improvement in harvesting efficiency.

#### 3.11.1 Break Even Point (BEP)

The break-even point is at which neither profit is made nor loss incurred. The break-even point is equal to the annual fixed cost divided by difference between the custom rate per hour and the operating cost per hour. The break-even point was calculated as

$$\text{BEP} = \frac{\text{AFC}}{\text{CF} - \text{C}} \quad \dots (3.35)$$

Where,

- BEP = Break-even point, h yr<sup>-1</sup>
- AFC = Annual fixed cost for the machine, Rs. yr<sup>-1</sup>
- CF = Custom fee, Rs. h<sup>-1</sup>
- C = Operating cost, Rs. h<sup>-1</sup>
- CF = (cost of operation h<sup>-1</sup> + 25 per cent overhead charges) + (25 per cent profit over new cost)

#### 3.11.2. Pay Back Period (PBP)

It is the number of year it would take for an investment to return its original cost through the annual cash revenues it generates, if the net cash revenues are constant each year. The payback period is calculated as

$$\text{PBP} = \frac{\text{IC}}{\text{ANF}} \quad \dots (3.36)$$

Where,

PBP = Payback period, yr

IC = Initial cost of the machine, Rs

ANP = Average net annual profit, Rs yr<sup>-1</sup>

ANP = (CF – C) x AU

AU = Annual use, h yr<sup>-1</sup>

### 3.11.3 Benefit Cost Ratio

Benefit cost per hectare = Cost of manual harvesting – Cost of machine harvesting

Therefore,

$$\text{Benefit cost ratio} = \frac{\text{Benefit cost}}{\text{Cost of machine harvesting}} \quad \dots (3.37)$$

Benefit cost per hectare, Rs. ha<sup>-1</sup>

B: C ratio should be more than one

---

---

## **RESULTS AND DISCUSSION**

## CHAPTER IV

### RESULTS AND DISCUSSION

In this chapter, the soil, crop and machine parameters pertaining to the design of the tractor operated root crop harvester is explained. Experimental trials were conducted to determine optimum levels of digging and soil separator units under different operating conditions and the results of the data are statistically analyzed and discussed. The effects of operational parameters on performance of tractor drawn root crop harvester for harvesting tuber/rhizome under actual field conditions are also discussed. Based on these optimized parameters, the developed root crop harvester was further refined and tested in farmer's fields to evaluate the overall performance of the machine. The cost economics of the developed tractor drawn root crop harvester was compared with the conventional method.

#### 4.1 SOIL PARAMETERS

The soil parameters such as soil type, moisture content, bulk density, cone index and shear strength were found out at the time of harvest. These properties were determined as explained in section 3.1. The data was statistically analysed and the results are presented in Table 4.1.

##### 4.1.1 Soil type

The soil samples taken separately from the cultivated fields of coleus, ginger and turmeric experimental trials were mechanically analysed for finding its textural composition. The percentage of different textures ranged between 62-63, 10-11 and 26-27 per cent sand, silt and clay in all these fields respectively. Hence, it was concluded that the type of soil was sandy clay loam soil in coleus field. The percentage of different textures ranged between 44-47, 29-30 and 23-25 per cent sand, silt and clay in all these fields respectively. Hence, it was concluded that the type of soil was laterite in ginger and turmeric fields.

##### 4.1.2 Moisture content

The soil moisture content was measured at different places of the experimental trial plot at the time of harvesting. The moisture content of the soil was determined

and statistically analysed. The moisture content varied from 14.50 to 17.34 per cent with mean of 15.71 per cent and a coefficient of variation of 8.09 per cent with standard deviation of 1.27. A favourable moisture level was chosen where the required draft and the soil penetration resistance were moderate and within the working limits for obtaining maximum harvesting efficiency. Therefore, harvesting at about 15.71 per cent soil moisture content in laterite and sandy clay loam soil was the best suitable field condition for obtaining maximum harvesting efficiency by mechanical means. Hence the experiments on performance study of the machine variables were conducted at this soil moisture level.

#### **4.1.3 Bulk density**

The soil bulk density was measured at different places of the experimental trial plot at the time of harvesting. Soil samples were collected for analysis. The bulk density of soil was determined and statistically analysed. The bulk density of the soil ranged from 1590 to 1830 kg cm<sup>-2</sup> with an average mean of 1716.0 kg cm<sup>-2</sup>. The coefficient of variation was found out as 5.11 per cent and standard deviation of 87.6. It shows the variations in soil bulk density at respective soil moisture. It was observed that bulk density of soil increased with increase in soil moisture content and had a linear relationship.

#### **4.1.4 Cone index**

The cone index of soil was determined and statistically analysed. The cone index varied from 0.83 to 1.51 kg cm<sup>-2</sup>. The highest value of the cone index was 1.51 kg cm<sup>-2</sup> at the soil moisture of 14.50 per cent. The cone penetration resistance values varied from 0.83-1.51 kg cm<sup>-2</sup> and as the depth increased from the surface, the penetration resistance was also increased. The highest value of the cone index was found out as 1.51 kg cm<sup>-2</sup> at the soil moisture of 14.50 per cent. As the depth increased from surface, penetration resistance was also increased.

#### **4.1.5 Shear strength**

The shear strength of soil was determined and analysed statistically. The shear strength of soil varied from 0.0128 to 0.0142 kg cm<sup>-2</sup> with mean of 0.0136 kg cm<sup>-2</sup>.



The coefficient of variation was found out as 4.36 per cent. The highest value of shear strength of soil at the soil moisture content of 14.50 per cent at 10 cm depth of soil. The coefficient of variation was found out as 4.36 per cent.

**Table.4.1 Properties of soil parameters at the time of harvesting of coleus, ginger and turmeric**

S. No.	Moisture content, (db) per cent			Bulk density, kg m <sup>-3</sup>			Cone index, kg cm <sup>-2</sup>			Shear strength, kg cm <sup>-2</sup>		
	Coleus	Ginger	Turmeric	Coleus	Ginger	Turmeric	Coleus	Ginger	Turmeric	Coleus	Ginger	Turmeric
1	18.40	18.54	17.34	1850	1865	1830	1.31	1.53	1.51	0.015	0.0125	0.0128
2	18.11	17.51	16.77	1740	1710	1750	1.15	1.29	1.35	0.012	0.0136	0.0132
3	17.36	17.11	15.24	1660	1669	1720	1.05	1.18	1.16	0.019	0.0129	0.0139
4	16.21	15.61	14.71	1580	1619	1690	0.94	0.96	0.98	0.013	0.0128	0.0140
5	15.90	14.89	14.50	1575	1605	1590	0.89	0.85	0.83	0.011	0.0122	0.0142
<b>Range</b>	2.50	3.60	2.84	275	260	240.0	0.42	0.68	0.68	0.008	0.0014	0.0014
<b>Mean</b>	17.19	16.73	15.71	1681	1693.60	1716.00	1.068	1.16	1.16	0.014	0.012	0.0136
<b>S.D</b>	1.11	1.47	1.27	116.10	104.50	87.60	0.168	0.269	0.27	0.003	0.0005	0.00059
<b>C.V</b>	6.48	8.80	8.09	6.91	6.17	5.11	15.78	23.18	23.48	22.59	4.10	4.36

## 4.2 CROP PARAMETERS

Crop parameters such as biometric, physical and frictional parameters were studied separately for these crops. The biometric parameters include the number of leaves, height of plant, depth of tuber/rhizome, plant density, spacing, tuber/rhizome weight and number of tuber/rhizome fingers per hill. The data related to these parameters were used in the design of functional components of the root crop harvester. The data of the biometric observations of root crops in the field at the time of harvesting data are presented in Appendix - I.

### 4.2.1 Number of leaves

The number of leaves per plant varied from 15-25, 11-29 and 6-12 for coleus, ginger and turmeric respectively, with an average of 20.90, 19.60 and 9.20 at the time of harvesting.

### 4.2.2 Height

The plant height of root crops ranged from 50-70, 16.0-35.0 and 20-50 cm with a mean of 56.52, 24.70 and 39.50 cm for coleus, ginger and turmeric respectively.

### 4.2.3 Depth of tuber/rhizome

The depth of the tuber/rhizome in soil was varied from 8-10 cm, 11-20 and 15-21cm with an average of 8.96, 16.45 and 18.15 cm for coleus, ginger and turmeric respectively.

### 4.2.4 Plant density

The plant density of tuber/rhizome were found out as 15-18, 9-12 and 9-12 numbers for coleus, ginger and turmeric respectively. Accordingly the mean of plant density of tuber/rhizome were found out as 16, 10 and 11 for coleus, ginger and turmeric respectively.

### 4.2.5 Spacing

Plant to plant spacing of tuber/rhizome varied from 15-16, 20-25 and 20-25 cm and average values of 15.20, 24.2 and 23.90 cm for coleus, ginger and turmeric

respectively whereas row to row spacing of tuber/rhizome varied from 30, 25-30 and 25-30 cm with mean of 30.10, 28.90 and 28.30 cm for coleus, ginger and turmeric respectively.

#### **4.2.6 Tuber/rhizome soil composite**

The tuber/rhizome soil composite varied from 7-12, 11-21 and 17-20 cm with a means of 9.55, 17.45 and 18.60 cm for coleus, ginger and turmeric respectively. Also noted that distribution of the crops in horizontal and vertical directions on the soil surface ranged from 10.60 to 20.70 cm with an average of 14.60 cm. The weight of the tuber/rhizome soil composite is an important parameter in the design of soil separator unit of the harvester. The weight of rhizome varied from 0.20-0.35, 0.35 to 1.13 and 0.45-0.75 kg and the mean values were 0.289, 0.764 and 0.615 kg for coleus, ginger and turmeric respectively. The number of fingers per hill is also an important parameter as it determines the volume of crop to be handled by the machine. The number of rhizome fingers per hill ranged from 8-15, 5-14 and 3-12 and mean value were 11.10, 10 and 8.20.

The weight of rhizome with leaves is an important parameter which determines the total volume of crop to be handled by the machine as well as the length of the soil separator to be decided.

### **4.3 PHYSICAL PROPERTIES OF TUBER/RHIZOME**

The physical properties of rhizome/tubers *viz.*, size, geometric mean diameter, sphericity, rhizome index, surface area, bulk volume and bulk density were determined and analyzed statistically. The data obtained are presented in Appendix – II, III and IV.

#### **4.3.1 Size**

The major, minor and intermediate diameter of coleus was found out as 4.86, 3.37 and 2.38 cm. Similarly, 16.52, 9.75 and 4.08 cm for ginger and 13.83, 10.12 and 3.56 cm for turmeric. Accordingly, the geometric mean diameters were found out as 3.29, 8.80 and 7.83 cm for coleus, ginger and turmeric respectively.

#### **4.3.2 Sphericity**

The average values of sphericity were 0.69, 0.53 and 0.57 for coleus, ginger and turmeric respectively,

#### **4.3.3 Bulk density**

The average bulk volume and bulk density were found out as 179.30, 211.20 and 194.2 cm<sup>3</sup> and 720.0, 491.82 and 481.63 kg m<sup>-3</sup> for coleus, ginger and turmeric, respectively. The bulk densities of the tubers/rhizomes are important parameter in designing the soil separator unit.

#### **4.3.4 Tuber/Rhizome Index**

The tuber/rhizome index was found out as 67.59, 42.18 and 39.95 per cent for coleus, ginger and turmeric respectively.

#### **4.3.5 Surface Area**

The average surface area determined was 35.56, 235.20 and 195.20 cm<sup>2</sup> for coleus, ginger and turmeric respectively.

#### **4.3.6 Moisture Content**

The moisture content of rhizomes/tubers at the time of harvest is another important parameter in digging out from the soil. The moisture content varied from 70.75 to 75.27 per cent (w.b.) with an average of 73.51 per cent. Since the moisture content of tubers/rhizomes at the time of harvest is very high, the soil has a tendency to adhere to the rhizome and it comes out along with the soil which increases the weight of tuber/rhizome soil composite by the machine. Ajav and Ogunlade (2014) reported that some deviations were observed from the average values which are of the physical properties. The physical properties increased with an increased in the moisture content except bulk density which decreased as the moisture content increased.

#### 4.4 FRICTIONAL PROPERTIES OF TUBER/RHIZOME

The major frictional properties of coleus, ginger and turmeric affecting the root crop harvester *viz.*, coefficient of friction, angle of repose and texture were determined, analyzed statistically and presented in Appendix -V and VI.

##### 4.4.1 Coefficient of friction

The range of coefficient of friction of coleus for stainless steel, plywood and galvanized iron were found out as 0.67 to 0.78, 0.78 to 0.83 and 0.69 to 0.75, respectively. The mean coefficient of friction for stainless steel, plywood and galvanized iron were found out as 0.702, 0.816 and 0.720 respectively. The coefficient of variation of stainless steel, plywood and galvanized iron were found out as 9.89, 4.38 and 3.33, respectively.

The range of coefficient of friction of ginger for stainless steel, plywood and galvanized iron were found out as 0.45 to 0.53, 0.50 to 0.66 and 0.48 to 0.59 respectively. The mean coefficient of friction for stainless steel, plywood and galvanized iron were found out as 0.500, 0.564 and 0.542 respectively. The coefficient of variation of stainless steel, plywood and galvanized iron were found out as 6.32, 12.19 and 9.08 respectively.

The range of coefficient of friction of turmeric for stainless steel, plywood and galvanized iron were found out as 0.53 to 0.61, 0.72 to 0.79 and 0.61 to 0.71 respectively. The mean coefficient of friction for stainless steel, plywood and galvanized iron were found out as 0.57, 0.75 and 0.66 respectively. The coefficient of variation of stainless steel, plywood and galvanized iron were found out as 5.95, 4.14 and 5.99 respectively.

##### 4.4.2 Angle of repose

The angle of repose of coleus, ginger and turmeric were measured as 37.60, 34.33 and 31.69 deg. respectively. The angle of repose is the determining factor in the design of the lifting the fingers of the soil separator unit. The values obtained are in accordance with the results of Yerima *et al.*, (2016).

#### **4.4.3 Texture**

Firmness is the characteristic of a material expressing its resistance to permanent deformation. Firmness of coleus, ginger and turmeric is an indicator of good edible quality of the tuber/rhizome with more consumer appeal. The maximum and minimum firmness for coleus were found out as 296.35 and 187.26 N respectively similarly 163.44 and 277.96 N for ginger and 59.67 and 81.44 N for turmeric, respectively. The average values of firmness were found as 233.20, 214.2 and 67.83 N and standard deviation of firmness were 43.50, 50.60 and 8.94 and coefficient of variation of firmness were 18.64, 23.63 and 13.18 for coleus, ginger and turmeric, respectively. The results are presented in Appendix-VI.

#### **4.5 MACHINE PARAMETERS**

The machine parameters of the tractor drawn root crop harvester were size, shape, rake angle of the digging unit and diameter of crank, spring tension and speed of the crank of the soil separator unit.

##### **4.5.1 Blade geometry**

The following three levels of blade geometry at constant blade width of 900 mm, length of 200 mm and thickness of 10 mm made of M.S. flat were selected for experimentation such as V-type blade, Crescent type blade and Straight edge type blade.

##### **4.5.2 Rake angle of the blade**

Present investigation was conducted with the experimental set up of the root crop harvester at three levels of rake angles of 15, 20 and 25 deg. at a constant width of 900 mm of digging unit of the harvester.

##### **4.5.3 Diameter of crank**

The three levels of diameter of crank were selected as 40, 60 and 80 mm for experimental trials of the soil separator unit and 80 mm diameter of crank was optimized based on the displacement analysis and experimental trials.

#### **4.5.4 Speed of crank**

The three different levels of crank speed were selected as 200, 220 and 240 rpm and analysed in the ADAMS software for velocity and acceleration analysis of the model. The speed of the crank 220 rpm was selected for the crank on the velocity and acceleration analysis results.

#### **4.5.5 Spring tension**

Three different levels of spring tensions were selected as 800, 1200 and 1600 N m<sup>-1</sup> for experimental trials for the lifting of finger assembly of soil separator unit.

### **4.6 DESIGN OF ROOT CROP HARVESTER**

The root crop harvester for harvesting root crops was designed and developed by considering soil, crop and machine parameters utilizing P.T.O power of the tractor. The main purpose was to design the machine for harvesting root crop with minimum draft requirement, maximum digging efficiency, low damage to tuber/rhizome and less fuel consumption along with greater soil separation and conveying efficiency at economic cost of operation. The machine consisted of main frame, power transmission system, digging unit and soil separator unit.

#### **4.6.1 Selection of prime mover**

A suitable prime mover was selected based on calculated total power requirement for the operation of root crop harvester. The total power required was sum of power required for digging the rhizome/tuber, lifting it on to the soil separator, operation of soil separator and power required for pulling the machine.

The prime mover was selected in such a way that, maximum number of farmers could be benefited using the root crop harvester. It was evident that tractor population and their utilization have been more compared to power tiller usage. Hence, it was decided to design root crop harvester to suit tractors and hence could be useful to the farming community.



#### ***4.6.1.1 Power required for digging unit***

The total width of raised bed system was 900 mm and it covered two to three rows selected crops with spacing between the crops was 300 x 300 x 300 mm. Hence, the width of cut for a single blade for all rows over a total width of 900 mm was selected. The maximum depth of operation required was 200 mm. The power required for digging soil and haulms were calculated and it was found out as 12.35 kW.

#### ***4.6.1.2 Power required for soil separator unit***

The power required for conveying the dug material to the rear of the harvester was determined and it was found out as 3.68 kW. The total power required for the harvester was 17.23 kW, but the available power from P.T.O tractor was above 28 kW. Therefore, the power required to operate the machine would be adequately provided from the drawbar and P.T.O of a 28 kW tractor.

#### ***4.6.1.3 Determination of draft on digging unit***

The working depth of digging blade was an important parameter from the design point of view as it directly affects the power requirement of a root crop harvester. This working depth of digging blade is mainly dependent on the depth of tuber/rhizome in the soil. The study on crop properties of root crops carried out in the field yielded that, the depth of tuber/rhizome was in range of 100-200 mm with a mean value of 200 mm. Considering the probable variation in depth of tuber/rhizome of different varieties in the soil and to harvest it without damage, the minimum depth of operation was selected as 200 mm.

The draft of the blade was calculated 344.70 kg using the general soil mechanics equation for a blade deforming the soil in two dimensions (Hettiarachi *et al.*, 1966). Usual variations in rake angle of the digging blade ranged between 15 to 25 deg. A rake angle of 20 deg. was considered for the determination of expected draft. The 20 deg. was the mean value of rake angle selected for experimental trial.

#### **4.6.2 Design of digger unit**

The blade was designed for its thickness on the basis of load acting on it. Three types of blade were designed for experimental purpose such as straight edge type, V-type and crescent type of blades. The dimensions of the digging blade was worked out as recorded in equation 3.20 and it was kept 10 mm thickness and the total width of blade was 900 mm as per requirement of digging operation.

#### **4.6.3 Throat clearance**

The size of the throat was determined keeping in view the ease of flow of material on soil separator unit. The width of the throat was limited to 900 mm because of the size of the blade selected. The height was determined on the basis of height of root crop leaves so that it should not get damaged during the operation and material handling by the digger. The maximum depth of operation of the digger was selected as 200 mm based on the distribution of tuber/rhizome in the soil.

Considering the average height of the root plant 300 mm and the depth of operation 200 mm, the total height of the soil-rhizome plant included was 500 mm. After lifting of soil-rhizome the volume would increase by 1.5 times of the original volume based on cut-fill ratio of the soil. The other material like weed etc. may also pass through the throat. Therefore, a clearance of 100 mm was provided in excess of the height of material. The total throat height of the digger was thus decided as 600 mm.

#### **4.6.4 Soil Separator Unit**

The soil separator unit was designed based on its functional requirements. The width of the soil separator was fabricated as 1000 mm on the basis of width of the blade. The length of the soil separator was designed by considering the total material to be handled by a harvester. The length of the soil separator was 600 mm fabricated using M.S. rod of 10 mm diameter and opening between the rods was selected 50 mm keeping in view the minimum size of rhizome/tube to be retained on the soil separator unit.

#### 4.7 DEVELOPMENT OF ROOT CROP HARVESTER

The prototype of the tractor drawn root crop harvester consisted of main frame, power transmission system, digging unit, soil separator unit. The specifications of prototype root crop harvester are presented in Table 4.2.

The main frame dimension was fabricated by considering the height of plant, width of bed and tractor track width. The main frame was made of mild steel channel for mounting power transmission system, digging unit and soil separator unit. The overall dimension of the main frame is 1540×540 mm.

The power transmission system has been made at two stages, first from P.T.O to machine gear box from which power is transmitted to crank of the crank rocker mechanism and also the same power is to soil separator unit by crank rocker mechanism unit.

The digging unit is to dig out the tuber/rhizome from the soil planted at a depth ranging from 10 to 20 cm. The digging blade was made of M.S of size L×W×T as were 900×200×10 mm. The blade was fitted at the fore front of the soil separator unit at an angle varied from 15 to 25 deg. with the horizontal. When the tractor is moving forward blade enters into the soil, the tuber/rhizome will move over the blade and then passed to the soil separator unit.

The soil separator unit consisted of soil separator of dimension 1000 x 600 mm. The soil separator consists of rods, these are made of mild steel rod of 10 mm diameter and 600 mm length. The numbers of rod are 10 and spacing between rods 50 mm.

**Table 4.2 Specifications of the root crop harvester**

<b>Sl. No.</b>	<b>Components</b>	<b>Specifications</b>
1	Overall dimensions	
	Length, mm	1600
	Width, mm	640
	Height, mm	1400
2	Main frame	
	Length, mm	1540
	Width, mm	540
	Height, mm	750
3	Digging unit	
	Type of blade	V-type
	Length, mm	900
	Thickness, mm	10
4	Power transmission system	
	Gear reduction in gear box	1:2.2
	Output speed of gear box, rpm	220
5	Crank rocker mechanism (Four bar linkage)	
	Crank, mm	80
	Connecting rod, mm	430
6	Soil separator unit	
	Length, mm	1000
	Width, mm	600
	Number of finger rods	10
	Number of springs	4
7	Weight of the harvester, kg	250

#### 4.8 TESTING AND OPTIMIZING OF THE DEVELOPED ROOT CROP HARVESTER

The tractor drawn root crop harvester was tested in field condition to determine the optimum operational parameters for harvesting coleus. The parameters selected for optimization include three types of blades *viz.*, straight edge, V-type and crescent, three rake angles *viz.*, 15, 20, 25 deg. and three forward speeds *viz.*, 1.5, 2.0 and 2.5 km h<sup>-1</sup> respectively. The levels of variables selected for the study are presented in Table 3.2. The test procedure is explained in Sec. 3.8. The effect of operational parameters were studied to evaluate the performance of root crop harvester in terms of draft, digging efficiency, damage of tuber/rhizome and fuel consumption separately for coleus, ginger and turmeric.

##### 4.8.1 The draft requirement for coleus

The effect of type of blade, rake angle and forward speed on draft of root crop harvester for coleus is presented in Appendix-VII. The minimum draft of 1418.66 N was obtained for straight edge blade at a rake angle of 15 deg. when the harvester was operated at a forward speed of 1.5 km h<sup>-1</sup>. The maximum draft of 2009.52 N was recorded at a forward speed of 2.5 km h<sup>-1</sup> at 25 deg. rake angle. An average draft of 1754.02N was observed for straight edge blade at different combinations of rake angle and forward speed.

In case of V- type blade, an average draft was recorded as 1456.83 N which was 20.00 per cent lesser than the straight edge blade. The maximum draft of 2009.52 N was recorded at the rake angle of 25 deg. at a forward speed of 2.5 km h<sup>-1</sup>. The maximum draft of 2009.52 N was recorded at the rake angle of 25 deg. at forward speed of 2.5 km h<sup>-1</sup> for crescent blade. An average draft of 1881.57 N was recorded which is 23 per cent more than that of V-type blade.

Analysis of variances on draft while uprooting coleus is presented in Table 4.3. The effect due to operational parameters and its interactions on draft is also presented. The type of tool geometry has significant influence on the draft requirement of root crop harvester along with rake angle and forward speed.

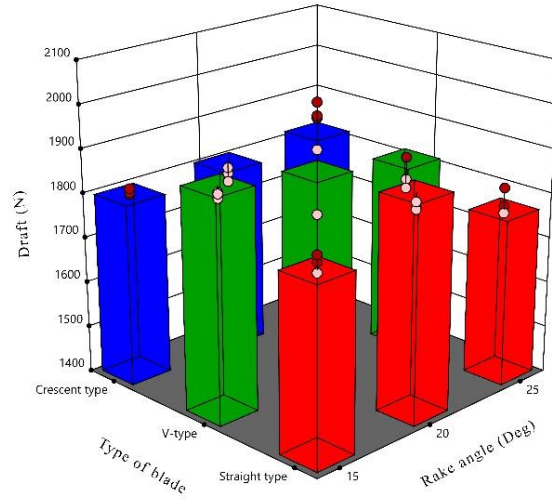
It also showed that both type of blade (B) rake angle (R) and forward speed (S) had significant effect on draft at 1 per cent level of significance. The interaction effects of (B x R), (B x S) and (R x S) significantly influenced the draft at 5 per cent level of significance. The standard deviation and coefficient of variation were found out as 48.14 and 2.75 per cent with a mean value of 1753.07 N. From the Fig. 4.1, it is obvious that, as the rake angle increased from 15 to 25 deg. the draft increased for all the types of blades at the forward speed of 1.5 km h<sup>-1</sup>. The minimum draft was noticed for V-type blade as compared to straight edge and crescent type blades. A draft of 23.00 per cent less than the straight edge blade at the rake angle of 15 deg. and forward speed of forward speed of 1.5 km h<sup>-1</sup> was obtained for V-type blade.

Similar trend was noticed for both the forward speed of 2.0 and 2.5 km h<sup>-1</sup> (Fig. 4.2 and 4.3). This might be due to different regimes of soil failure, different forces acting on the soil and also the tool geometry parameters. Similar results are in accordance with the results of V-type blade when used in onion digger (Khura *et al.*, 2011) and ginger harvester cum elevator (Kawale *et al.*, 2018).

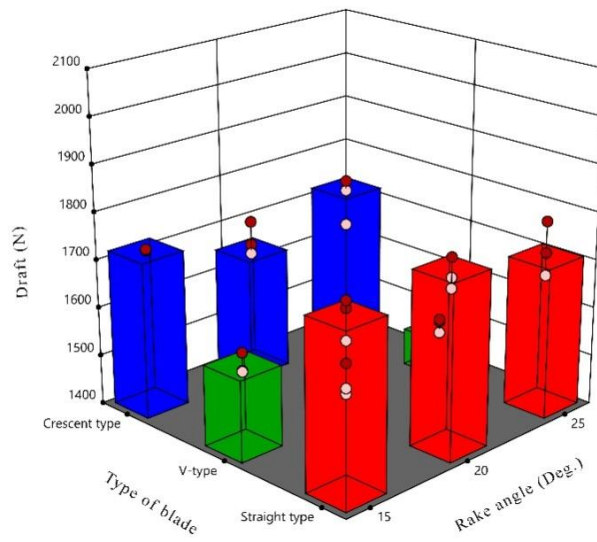
**Table 4.3. Analysis of variance on draft for harvesting coleus**

Source of variables (SV)	Sum of Squares (SS)	DF	Mean Square (MS)	F Value
Model	956300	18	53129.18	22.92 **
Type of blades (B)	167100	2	83556.63	36.05 **
Rake angle (R)	15045.69	2	7522.84	3.25 *
Forward speed (S)	458000	2	229000	98.80 **
B X R	57950.71	4	14487.68	6.25*
B X S	222900	4	55714.45	24.04 **
R X S	35393.28	4	8848.32	3.82 *
Residual	143700	62	2317.74	
Lack of Fit	45751.63	8	5718.95	3.15
Pure Error	97948.30	54	1813.86	
Cor Total	1100000	80		
Std. Dev.	48.14		R-Squared	0.86
Mean	1753.07		Adj R-Squared	0.83
C.V. %	2.75		Pred R-Squared	0.77
			Adeq Precision	18.77

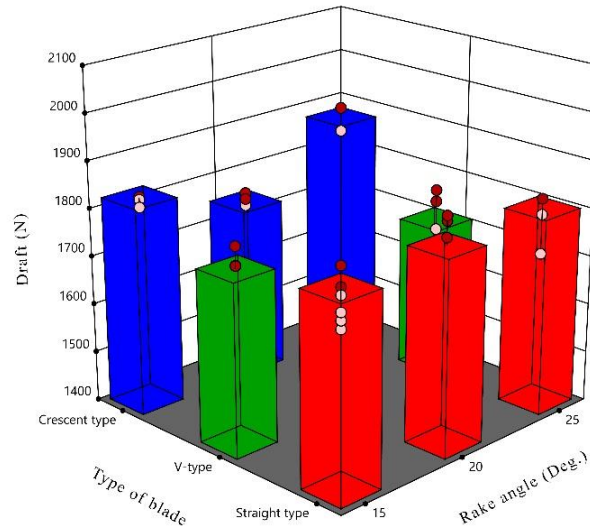
\* Significance at 1 Per cent level \*\* Significance at 5 Per cent level



**Fig.4.1 Draft requirement for harvesting coleus at 1.5 km h<sup>-1</sup>**



**Fig.4.2 Draft requirement for harvesting coleus at 2.0 km h<sup>-1</sup>**



**Fig.4.3 Draft requirement for harvesting coleus at 2.5 km h<sup>-1</sup>**

#### 4.8.2 Digging efficiency for harvesting coleus

The effects due to the type of blade, rake angle and forward speed on digging efficiency of harvesting coleus with the root crop harvester are presented in Appendix-VII.

A maximum digging efficiency of 93.99 per cent was observed at the rake angle of 25 deg. and forward speed at 2.5 kmh<sup>-1</sup> for straight edge blade where as a minimum of 84.15 per cent was observed at the rake angle 15 deg. and at forward speed of 1.5 km h<sup>-1</sup>. An average digging efficiency of 88.55 per cent was observed for straight edge blade at the different combinations of rake angle and forward speed.

In case of V- type blade, the average digging efficiency was observed as 97.63 per cent which was 11.00 per cent higher than the straight edge blade. The maximum digging efficiency of 99.89 per cent was observed at a rake angle of 25 deg. at forward speed of 2.5 km h<sup>-1</sup>. A digging efficiency of 95.20 per cent was observed as minimum at 15 deg. rake angle and at 1.5 km h<sup>-1</sup> forward speed.



Maximum digging efficiency of 99.35 per cent was observed in crescent blade at 25 deg. rake angle and at 2.5 km h<sup>-1</sup> forward speed whereas a minimum of 89.13 per cent was obtained at 15 deg. rake angle and at 2.0 km h<sup>-1</sup>. The mean value of 91.20 per cent was recorded in crescent blade which was 9.0 per cent less than the V-type blade.

Analysis of variance on digging efficiency for coleus is presented in Table 4.4. The effects due to operational parameters and its interactions on digging efficiency are also presented.

Among the three different type of blades tested, the maximum digging efficiency of 99.30 per cent was noticed in V-type blade at the forward speed of 2.0 km h<sup>-1</sup> and at 25 deg. rake angle (Fig.4.4). Whereas minimum digging efficiency of 84.15 per cent was observed in straight edge blade at the forward speed of 1.5 km h<sup>-1</sup> and rake angle of 15 deg.

Noticed that the main effects of each factor type of blade (B), rake angle (R) and forward speed (s) were significant at 1 per cent level of significance on digging efficiency. The interaction effect of (B x S) is significantly influence the digging efficiency at 5 per cent level of significance and the interaction effects of (B x S) and (R x S) are insignificant. The standard deviation and coefficient of variation were found out as 1.85 and 1.99 per cent with a mean value of 92.76.

Also observed that as the rake angle increased from 15 to 25 deg. digging efficiency for all the types of blades and for all the forward speed of operation was increased. Similar trends were observed for both the forward speed 2.0 and 2.5 km h<sup>-1</sup> (Fig.4.5 and 4.6).

It was seen that the digging efficiency increased as rake angle increased from 15 to 20 deg. but decreased with increase in rake angle. The digging efficiency was maximum at the rake angle of 20 deg. for all the combinations of variables. Increase in rake angle of V-type blade from 15 to 20 deg. for forward speed of 2.0 km h<sup>-1</sup> resulted in increase in digging efficiency of 5 per cent but showed a decreased trend when rake angle changed from 20 to 25 deg.

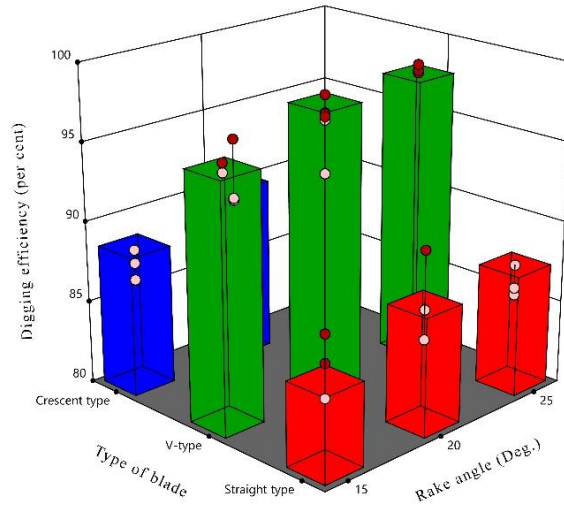
The lower digging efficiency at lower rake angle and lower forward speed might be due to insufficient depth of cut, hence resulted in reduced digging efficiency.

For increased rake angle of 25 deg. and forward speed of 2.5 km h<sup>-1</sup>, the digging efficiency was found decreased. It may be due to higher soil disturbance and lesser blade penetration. At optimum rake angle of 20 deg. and forward speed of 2.0 km h<sup>-1</sup> higher digging efficiency was obtained. This might be due to optimum depth of cut and hence the good tilth. Similar findings were obtained on harvesting root crops by inverted V blade with maximum tuber recovery and minimum damage (Vatsa *et al.*, 1993) and ginger harvester cum elevator (Kawale *et al.*, 2018).

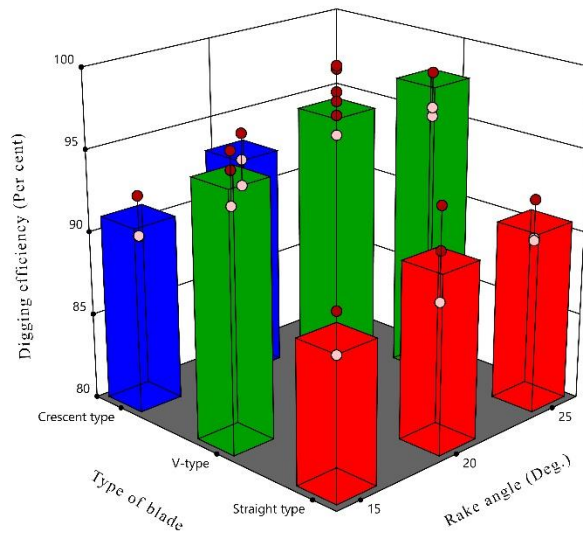
**Table 4.4 Analysis of variance on digging efficiency for coleus**

Source of variances	Sum of Squares	DF	Mean Square	F Value
Model	997.69	10	99.77	29.29 **
Type of blades (B)	750.17	2	375.08	110.12 **
Rake angle (R)	92.69	2	46.35	13.61 *
Forward speed (S)	87.03	2	43.52	12.78 **
B X S	67.80	4	16.95	4.98 *
Residual	238.43	70	3.41	
Lack of Fit	997.69	10	99.77	29.29
Pure Error	167.84	54	3.11	
Cor Total	1236.12	80		
Std. Dev.	1.85		R-Squared	0.80
Mean	92.76		Adj R-Squared	0.77
C.V. %	1.99		Pred R-Squared	0.74
			Adeq Precision	18.55

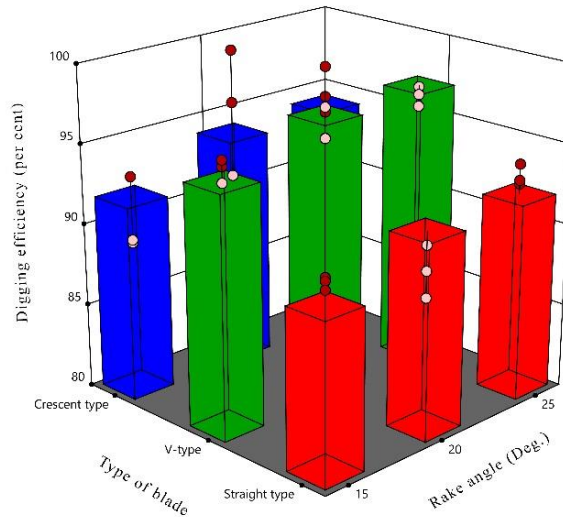
\* Significance at 1 % level \*\* Significance at 5 % level



**Fig. 4.4 Digging efficiency for harvesting coleus at 1.5 km h<sup>-1</sup>**



**Fig. 4.5 Digging efficiency for harvesting coleus at 2.0 km h<sup>-1</sup>**



**Fig. 4.6 Digging efficiency for harvesting coleus at 2.5 km h<sup>-1</sup>**

#### 4.8.3 Per cent damage of coleus

The effects due to the type of blade, rake angle and forward speed on damage of coleus due to the root crop harvester are presented in Appendix-VII.

For a straight edge blade, a minimum damage tuber of 0.59 per cent was recorded at rake angle 15 deg. and at 1.5 km h<sup>-1</sup> forward speed. The maximum per cent damage of 5.18 was observed at rake angle 25 deg. and forward speed 2.5 km h<sup>-1</sup>. A mean value of 4.2 per cent of damage was recorded for straight edge blade at the different combinations of rake angle and forward speed.

In case of V-type blade, the average damage was observed as 1.27 per cent which was 3.3 per cent less than the straight edge blade. The maximum per cent of damage of 3.17 was observed at 15 deg. rake angle and at 1.5 km h<sup>-1</sup> speed of operation where as minimum of 0.59 per cent of damage was obtained at 20 deg. rake angle and 2.0 km h<sup>-1</sup> speed of operation for V-type blade. In case of crescent blade, an average per cent damage of 5.06 was obtained in different combination of rake angle and speed of operations which was 75.09 per cent more than the V-type blade. The

maximum per cent damage of 5.5 per cent was noticed at a rake angle of 15 deg. and at 1.5 km h<sup>-1</sup> speed of operation.

Analysis of variance on per cent damage of coleus is presented in Table 4.5. The effect due to operational parameters and its interactions on per cent damage of tuber is also presented. It is noticed that, the effect of type of blade (B), rake angle (R) and forward speed (S) were significantly influenced individually on the damage of tuber at 5 per cent level of significance.

The interaction effects of (B x R) significantly influenced the damage of rhizome at 1 per cent level of significance. The interaction effects of (B x S) significantly influenced the damage of rhizome at 5 per cent level of significance. The standard deviation and coefficient of variation were found out as 0.42 and 11.29 per cent with a mean value of 3.77. It was observed that as the rake angle increased from 15 to 20 deg., the per cent damage of tuber was found decreased. Further increase in rake angle from 20 to 25 deg., there was a slight reduction in damage of tuber. The similar trend was obtained in all the combinations of variables (Fig.4.7).

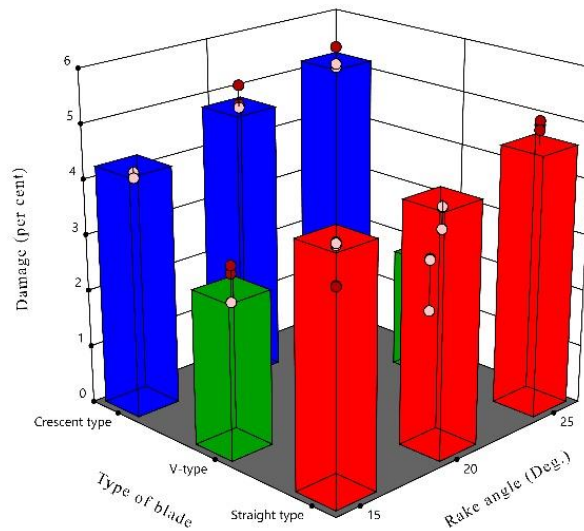
The least damage to tuber of 0.59 per cent was observed in V-type blade at rake angle of 20 deg. and forward speed of 2.0 km h<sup>-1</sup>. A highest damage of tuber of 5.5 per cent as obtained in crescent blade at 15 deg. rake angle and at forward speed of 1.5 km h<sup>-1</sup>. It was also observed that as the rake angle increased, the per cent damage to the tuber decreased (Fig.4.7).

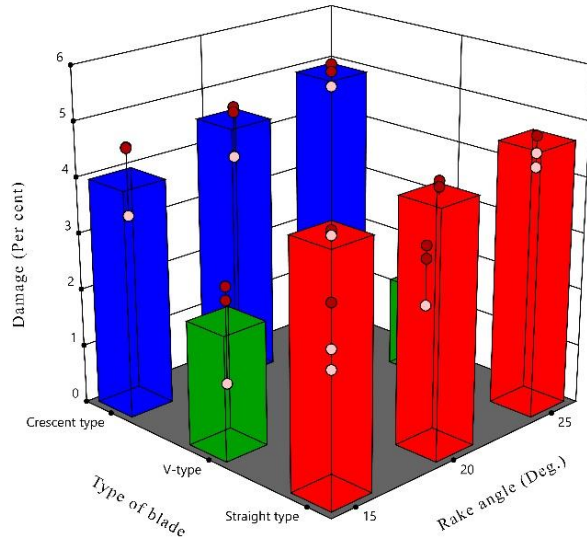
Similar trend was observed for all the combinations for the forward speed of 2.0 km h<sup>-1</sup> and 2.5 km h<sup>-1</sup> (Fig. 4.8 and Fig. 4.9). The higher damage of tuber at lower rake angle might be due to the reduced penetration. Hence more damage of tuber was observed. Again the forward speed also had considerable effect on percentage damage of tuber. At an optimum speed of 2.0 km h<sup>-1</sup>, there was sufficient depth of cut and optimum soil loosening effect, hence less damage of tubers were observed. Further increase in forward speed upto 2.5 km h<sup>-1</sup> resulted in higher tuber damage. This might be due to reduced blade penetration and higher soil disturbance, which in turn resulted in increased damage. Similar findings were reported by Vatsa *et al.*, (1993) who reported that the use of inverted V blade resulted minimum damage in potato.

**Table 4.5 Analysis of variance on per cent damage of harvesting coleus**

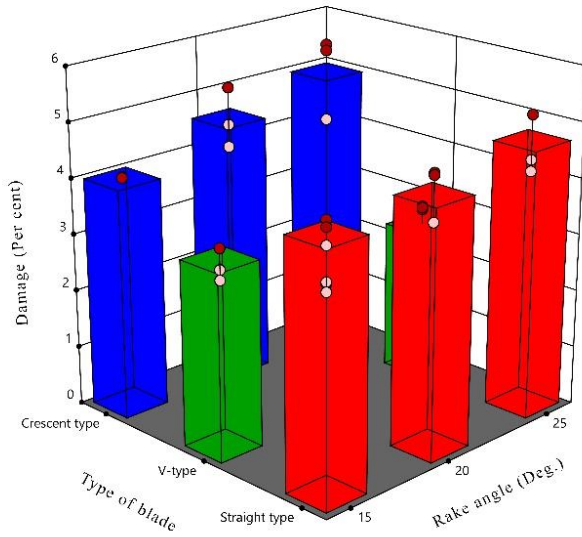
Source of variances	Sum of Squares	DF	Mean Square	F Value
Model	110.32	14	7.88	43.50 **
Type of blades (B)	95.89	2	47.94	264.65 **
Rake angle (R)	1.85	2	0.9226	5.09 *
Forward speed (S)	1.98	2	0.9922	5.48 *
B X R	6.98	4	1.75	9.64**
B X S	3.62	4	0.9050	5.00*
Residual	11.96	66	0.1812	
Lack of Fit	2.80	12	0.233	1.38
Pure Error	9.16	54	0.1696	
Cor Total	122.28	80		
Std. Dev.	0.42		R-Squared	0.90
Mean	3.77		Adj R-Squared	0.88
C.V. %	11.29		Pred R-Squared	0.85
			Adeq Precision	21.64

\*\* Significance at 1 % level \*Significance at 5 % level

**Fig. 4.7 Per cent damage of coleus at 1.5 km h<sup>-1</sup>**



**Fig. 4.8** Per cent damage of coleus at 2.0 km h<sup>-1</sup>



**Fig.4.9** Per cent damage of coleus at 2.5 km h<sup>-1</sup>

#### 4.8.4 Fuel consumption for harvesting coleus

The effects of operational parameters *viz.* type of blade, rake angle and forward speed on fuel consumption for harvesting coleus using tractor drawn root crop harvester are presented in Appendix-VII.

For a straight edge blade, a minimum fuel consumption of  $3.8 \text{ l h}^{-1}$  was obtained at a rake angle of 15 deg. and at the forward speed of  $1.5 \text{ km h}^{-1}$ . The maximum fuel consumption of  $4.97 \text{ l h}^{-1}$  was recorded at 25 deg. rake angle and at  $2.5 \text{ km h}^{-1}$  forward speed of operation. An average fuel consumption of  $4.51 \text{ l h}^{-1}$  was noticed for straight edge blade at the different combinations of rake angle and forward speed of operation.

In case of V-type blade the average fuel consumption of  $4.08 \text{ l h}^{-1}$  was observed which 10 per cent was less than the straight edge blade. The maximum fuel consumption of  $4.18 \text{ l h}^{-1}$  recorded at the rake angle of 25 deg. and forward speed of  $2.5 \text{ km h}^{-1}$ . The minimum fuel consumption of  $3.8 \text{ l h}^{-1}$  was noticed at the rake angle of 15 deg. and forward speed of  $1.5 \text{ km h}^{-1}$ .

For crescent blade, the average fuel consumption of  $4.5 \text{ l h}^{-1}$  was recorded which was 16 per cent more than the V-type blade. This blade has got maximum fuel consumption of  $4.98 \text{ l h}^{-1}$  at the rake angle of 25 deg. and at the forward speed of  $2.5 \text{ km h}^{-1}$  whereas minimum fuel consumption of  $4.20 \text{ l h}^{-1}$  was noticed at 15 deg. rake angle and the forward speed of  $2.0 \text{ km h}^{-1}$ . Among the different type of blades the less fuel consumption of  $3.80 \text{ l h}^{-1}$  was noticed for V-type blade at the rake angle of 20 deg. and at the forward speed of  $2.0 \text{ km h}^{-1}$ , whereas maximum of  $4.98 \text{ l h}^{-1}$  was noticed in crescent type blade at the rake angle of 25 deg. and at the forward speed of  $2.5 \text{ km h}^{-1}$ .

Analysis of variance on fuel consumption is presented in Table 4.5. The effect due to operational parameters and its interactions on fuel consumption is also presented. It is noticed that the effect of type of blade (B) and forward speed (S) significantly influenced the fuel consumption at 5 per cent level of significance and both variables individually influenced on the fuel consumption. The effect of forward speed (S) individually on fuel consumption was significantly influenced at 1 per cent



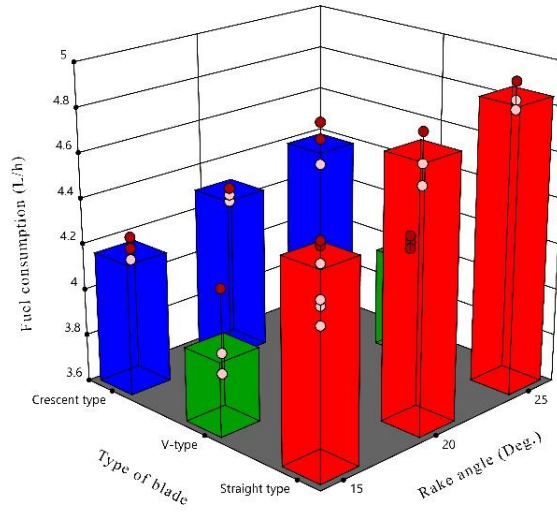
level of significance. The interaction effect of (B x R) significantly influenced on the fuel consumption at 5 per cent level of significance. The standard deviation and coefficient of variation were found out as 0.088 and 2.01 per cent with a mean value of 4.36.

From Fig.4.10 it was noticed that the increase in rake angle of the harvester increased the fuel consumption of the tractor engine. The similar trend was obtained for all the combinations of types of blades and forward speed of tractor as shown in Fig 4.11 and 4.12. Similar findings were reported by (Kawale *et al.*,2018) and Gulsoylu *et al.* (2012).

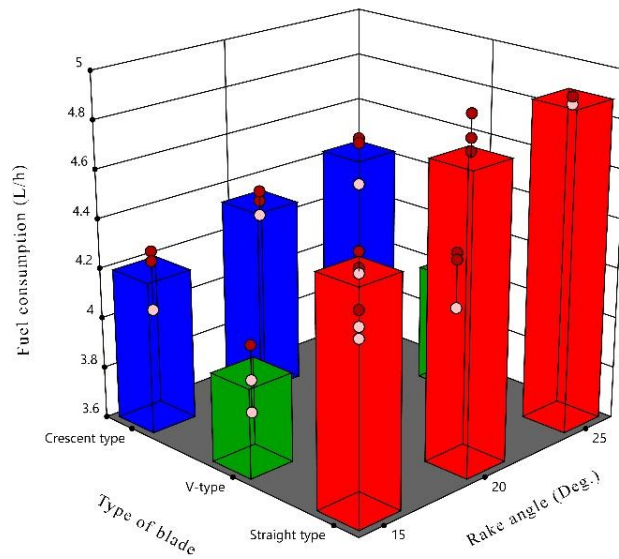
**Table 4.6. Analysis of variance on fuel consumption of tractor for coleus**

Source of variances	Sum of Squares	DF	Mean Square	F Value
Model	7.95	10	0.7954	103.16 **
Type of blades (B)	6.86	2	3.43	444.95 **
Rake angle (R)	0.8192	2	0.4096	53.12 *
Forward speed (S)	0.0854	2	0.0427	5.54 *
B X R	0.1877	4	0.0469	6.09 *
Residual	0.5397	70	0.0077	
Lack of Fit	0.0973	16	0.0061	0.74
Pure Error	0.4424	54	0.0082	
Cor Total	8.49	80		
Std. Dev.	0.087		R-Squared	0.93
Mean	4.36		Adj R-Squared	0.92
C.V. %	2.01		Pred R-Squared	0.91
PRESS			Adeq Precision	31.22

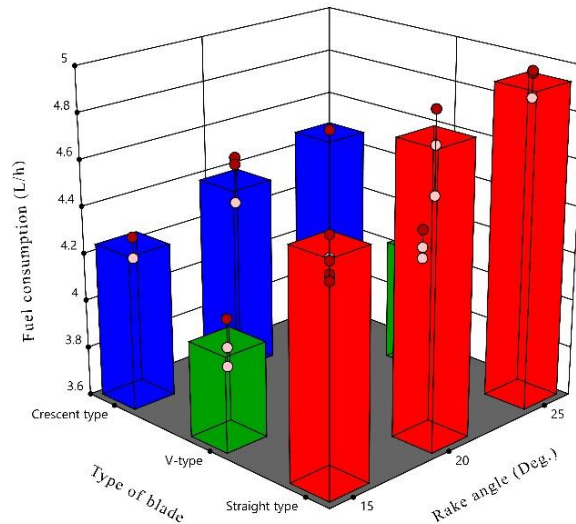
\*\* Significance at 1 % level    \* Significance at 5 % level



**Fig.4.10 Fuel consumption for harvesting coleus at 1.5 km h<sup>-1</sup>**



**Fig. 4.11 Fuel consumption for harvesting coleus at 2.0 km h<sup>-1</sup>**



**Fig. 4.12 Fuel consumption for harvesting coleus at 2.5 km h<sup>-1</sup>**

#### 4.8.5 Conveying efficiency and soil separation index for coleus

The effect of diameter of crank and spring tension on conveying efficiency and soil separation index for coleus were carried out with the tractor drawn root crop harvester and the results are presented in Appendix-X.

It was observed that the average conveying efficiency of 86.67 per cent was obtained from different combinations of diameter of crank and spring tension. The maximum conveying efficiency of 89.82 per cent was noticed for 80 mm diameter of crank at 1600 N m<sup>-1</sup> spring tension. The least conveying efficiency of 79.10 per cent was noticed for 40 mm diameter of crank at 800 N m<sup>-1</sup> spring tension. The conveying efficiency was increased by 10 per cent when the spring tension was increased from 800 to 1600 N m<sup>-1</sup> (Fig.4.14).

Individual variables like crank diameter(C) and spring tension (T) on conveying efficiency was significantly influenced at 1 per cent level of significance. The standard deviation and coefficient of variation were found out as 1.32 and 1.52 per cent with a mean value of 86.67. (Table 4.9)

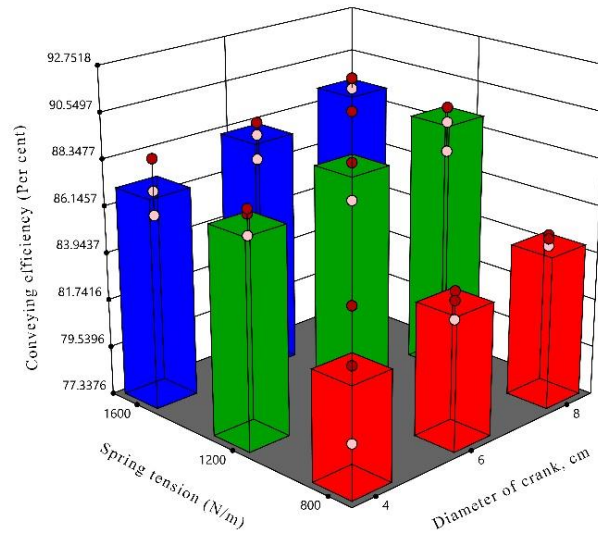
It was also seen that the average soil separation index was found out 78.53 per cent from different spring tensions and diameter of crank. The maximum soil separation index was noticed for 80 mm diameter of crank followed by 60 and 40 mm, respectively. The increase in separating index by 10 per cent and 7.14 per cent was found as the diameter of crank increased from 40-60 mm and 60-80 mm, respectively (Fig.4.15).

The individual and combined effects of operational parameters on soil separation index were analyzed statistically and are presented in Table 4.10. The results showed that, the effect of diameter of crank (C) and spring tension (T) significantly influenced the soil separation index at 5 per cent level of significance and both variables individually influenced the soil separation index. The standard deviation and coefficient of variation were found out as 1.45 and 1.84 per cent respectively with a mean value of 78.53. Similar findings were reported by (Kawale *et al.*, 2018).

**Table. 4.7 Analysis of variance on conveying efficiency for coleus**

Source of variances	Sum of Squares	DF	Mean Square	F Value
Model	153.30	4	38.33	22.00 **
Diameter of crank (A)	19.98	2	9.99	5.73 **
Spring tension (B)	133.33	2	66.66	38.26 **
Residual	38.33	22	1.74	
Lack of Fit	1.92	4	0.479	0.23
Pure Error	36.41	18	2.02	
Cor Total	191.63	26		
Std. Dev.	1.32	R-Squared	0.80	
Mean	86.67	Adj R-Squared	0.76	
C.V. %	1.52	Pred R-Squared	0.69	
PRESS	57.73	Adeq Precision	12.10	

\*\* = Significance at 1 %    \* = Significance at 5 %

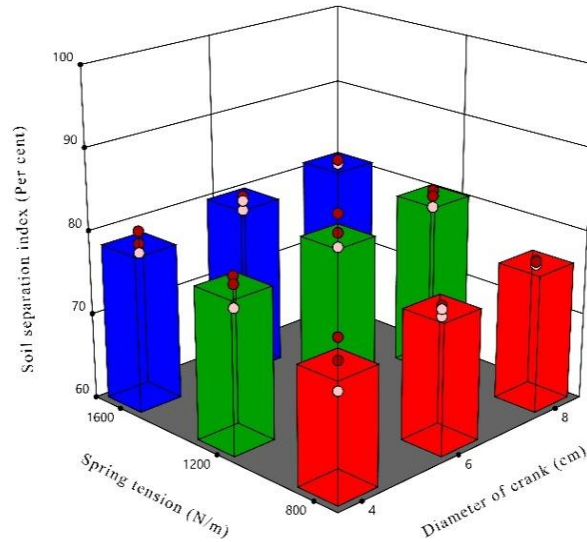


**Fig. 4.13** The conveying efficiency for coleus

**Table. 4.8** Analysis of variance on soil separation index for coleus

Source of variances	Sum of Squares	DF	Mean Square	F Value
Model	152.28	4	38.07	18.21 **
Diameter of crank(A)	29.83	2	14.92	7.14**
Spring tension (B)	122.45	2	61.22	29.29 **
Residual	45.98	22	2.09	
Lack of Fit	2.75	4	0.6865	0.28
Pure Error	43.24	18	2.40	
Cor Total	198.26	26		
Std. Dev.	1.45		R-Squared	0.76
Mean	78.53		Adj R-Squared	0.72
C.V. %	1.84		Pred R-Squared	0.65
PRESS	69.26		Adeq Precision	11.70

\*\* Significance at 1 % level \*Significance at 5 % level



**Fig. 4.14** The soil separation index for coleus

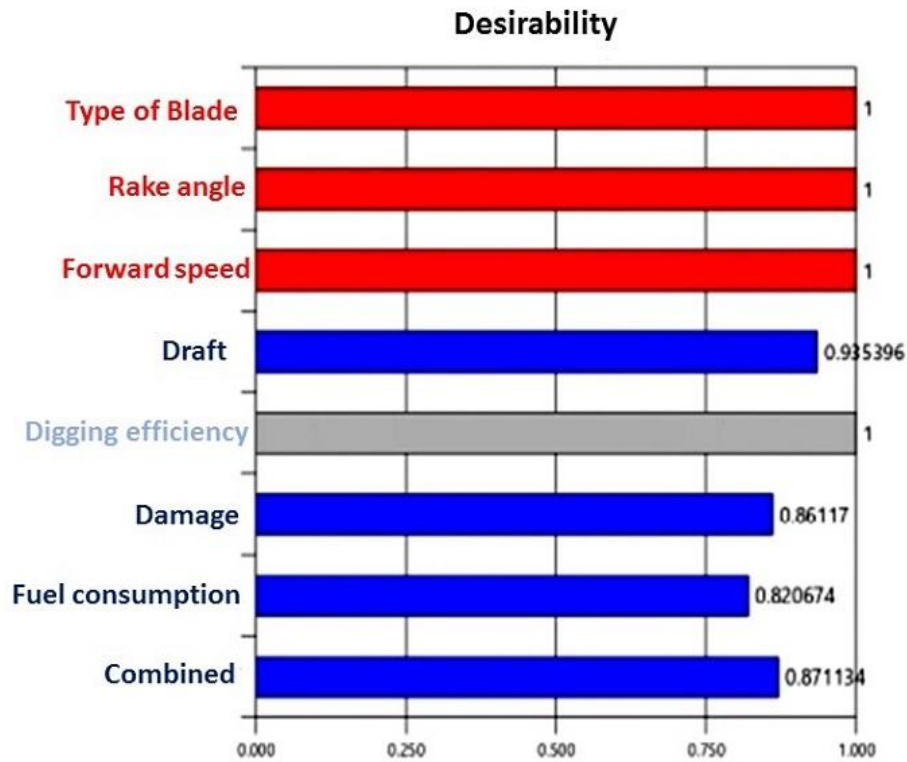
#### 4.9 OPTIMIZATION FOR DIGGING UNIT FOR COLEUS

Numerical optimization technique was adopted to get optimum levels of independent variables for the designed and tested models using “Design Expert 12.0.4” version software. Optimization constraints of experiments are presented in Table 4.7 and best optimal solutions are presented in the Table 4.8.

##### 4.9.1 Desirability index for digging unit

Desirability is simply a mathematical method to find the optimum levels for satisfactorily functioning of any system. The factors such as type of blade, rake angle and forward speed affected on the draft, digging efficiency, per cent damage and fuel consumption of digging unit. Accordingly, optimized constraints are given in Table 4.7, from these values the best optimal solutions are found out and given in Table 4.8.

Best desirability index of 0.87 was obtained for the digging unit for combinations of V-type blade, 20 deg. rake angle and 2.0 km h<sup>-1</sup> as shown in Fig 4.13.



**Fig.4.15 Desirability index for digging unit for coleus**

**Table 4.9 Numerical optimization constraints on digging unit**

Name	Goal	Lower Limit	Upper Limit	Lower Weight	Upper Weight	Importance
Type of Blade	is in range	Straight edge type	Crescent type	1	1	3
Rake angle	is in range	15	25	1	1	3
Forward speed	is in range	1.5	2.5	1	1	3
Draft	minimize	1418.66	2009.52	1	1	3
Digging efficiency	maximize	84.1596	99.891	1	1	3
Damage	minimize	0.59	5.5	1	1	3
Fuel consumption	minimize	3.8	4.98	1	1	3

**Table 4.10. Best optimal solutions of digging unit for harvesting coleus**

<b>Sl. No.</b>	<b>Variables</b>	<b>Optimal Values</b>
1	Tool geometry	V – Type
2	Rake angle	20deg.
3	Forward speed	2.0 km h <sup>-1</sup>

#### 4.10 OPTIMIZATION OF SOIL SEPARATOR UNIT FOR HARVESTING COLEUS

The soil separator unit was tested with different treatment combinations of diameter of crank *viz.*, 40, 60 and 80 mm and spring tension *viz.*, 800, 1200 and 1600 N m<sup>-1</sup> respectively. The operational parameters of the soil separator unit were optimized based on the performance parameters of the soil separator unit such as soil separation index and conveying efficiency.

Numerical optimization technique was adopted to get optimum levels of independent variables for the designed and tested models using Design Expert 12.0.4 version. Optimization constraints of experiments are presented in Table 4.11 and two best optimal solutions are presented in the Table 4.12.

##### 4.10.1 Desirability index for soil separator unit

The highest desirability index of 0.887 was observed for the soil separator unit at a spring tension 1600 N m<sup>-1</sup> with 80 mm diameter of crank as shown in Fig. 4.16. Hence, this treatment combination of 80 mm diameter of crank and 1600 N m<sup>-1</sup> spring tension was chosen as the optimum for further field performance evaluation of the root crop harvester.



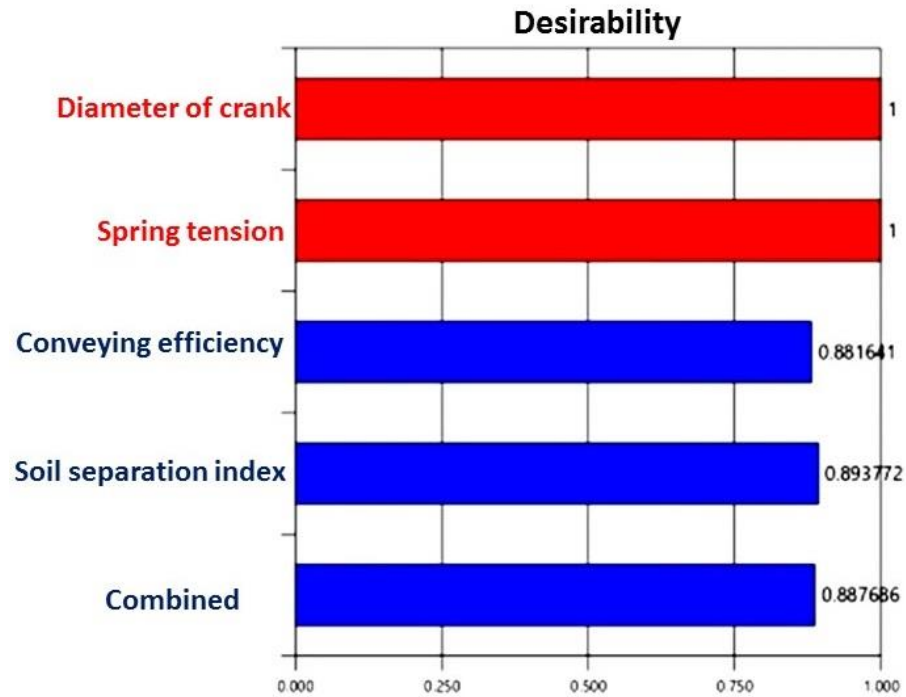


Fig. 4.16 Desirability index of soil separator unit for coleus

Table 4.11 Optimization constraints of soil separator unit for coleus

Name	Goal	Lower Limit	Upper Limit	Lower Weight	Upper Weight	Importance
Diameter of crank	is in range	4	8	1	1	3
Spring tension	is in range	800	1600	1	1	3
Conveying efficiency	maximize	79.1	90.7	1	1	3
Soil separation index	maximize	71.10	82.71	1	1	3

Table 4.12. Best optimal solutions of the soil separator unit for coleus

Sl. No.	Variables	Optimal Values
1	Tool geometry	V – type
2	Diameter of crank	8 cm
3	Spring tension	1600 N m <sup>-1</sup>

#### 4.11 TESTING AND OPTIMIZATION OF THE DEVELOPED ROOT CROP HARVESTER FOR GINGER

Similarly the tractor drawn root crop harvester was tested in field condition to determine the optimum operational parameters for harvesting ginger. The parameters selected for optimization include three types of blade *viz.*, straight edge, V-type and crescent, three rake angles *viz.*, 15, 20, 25 deg. and three forward speeds *viz.*, 1.5, 2.0 and 2.5 km h<sup>-1</sup> respectively. The effects of operational parameters were studied to evaluate the performance of root crop harvester in terms of draft, digging efficiency, damage of tuber/rhizome and fuel consumption.

##### 4.11.1 The draft requirement for ginger

The effect of type of blade, rake angle and forward speed on draft of root crop harvester is presented in Appendix-VIII.

The minimum draft of 1374.31 N was obtained for straight edge blade at a rake angle of 15 deg. when the harvester was operated at a forward speed of 1.5 km h<sup>-1</sup>. The maximum draft of 2176.33 N was recorded at a forward speed of 2.5 km h<sup>-1</sup> at 25 deg. rake angle. An average draft of 2017.28 N was observed for straight edge blade at different combinations of rake angle and forward speed.

In case of V-type blade, average draft recorded was 1449.10 N which was 29.00 per cent lesser than the straight edge blade. The maximum draft of 2176.33 N was recorded at the rake angle of 25 deg. and forward speed of 2.5 km h<sup>-1</sup> for the crescent blade. An average draft of 2010.29 N was recorded which is 28 per cent more than that of the V-type blade.

Analysis of variances on draft is presented in Table 4.13. The effect due to operational parameters and its interactions on draft is also presented.

It also showed that both type of blade (B) rake angle (R) and forward speed (S) had significant effect on draft at 5 per cent level of significance. The interaction effect of (B x R) significantly influenced the draft at 5 per cent level of significance. The standard deviation and coefficient of variation were found out as 36.75 and 1.94 per cent with a mean value of 1894.25 N.

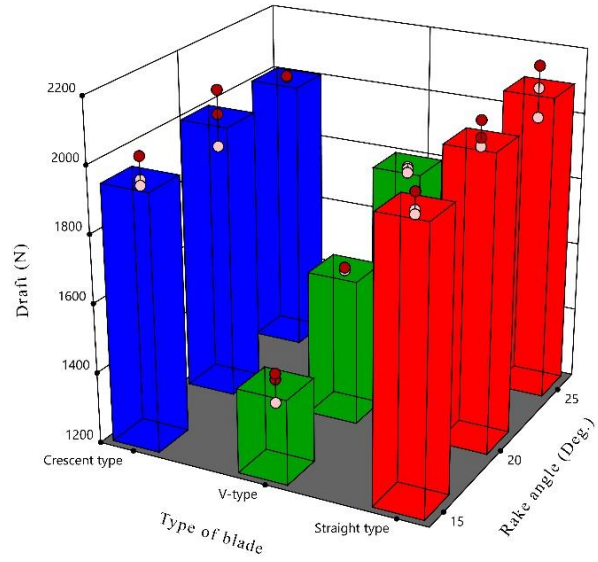
From the Fig. 4.17, it is obvious that, as the rake angle increased from 15 to 25 deg. the draft also increased for all the types of blades at the forward speed of 1.5 km h<sup>-1</sup>. The minimum draft was noticed as compared to straight edge and crescent type blades for V blade. A draft of 29 per cent less than the straight edge blade at the rake angle of 15 deg. and forward speed of 1.5 km h<sup>-1</sup> was obtained for V-type blade.

Similar trend was noticed for both the forward speed of 2.0 and 2.5 kmh<sup>-1</sup> (Fig. 4.18 and 4.19). This might be due to different regimes of soil failure, different forces acting on the soil and also the tool geometry parameters. These results are in accordance with the results of V-type blade when used in onion digger by (Khura *et al*, 2011) and Similar findings were reported when inverted V-type blade used by (Kawale *et al.*,2018)

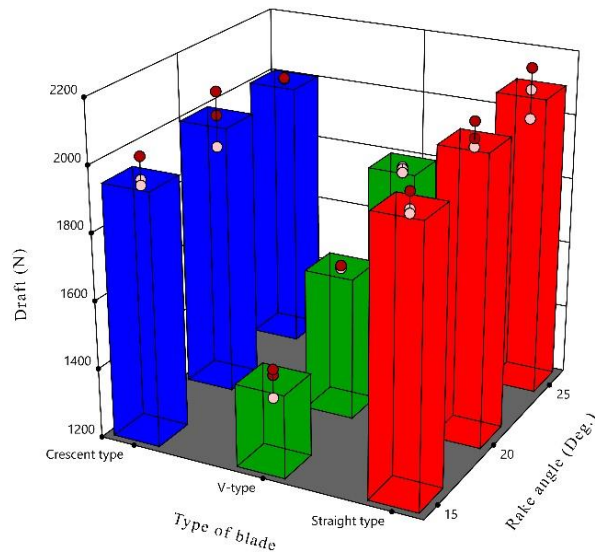
**Table.4.13 Analysis of variance on draft for harvesting ginger**

Source of variances	Sum of Squares	DF	Mean Square	F Value
Model	3589000	10	358900	265.72 **
Type of blades (B)	2924000	2	1462000	1082.55 **
Rake angle (R)	382300	2	191200	141.54 **
Forward speed (S)	257100	2	12612.40	9.34 *
B X R	257100	4	64266.56	47.58**
Residual	94542.48	70	1350.61	
Lack of Fit	14993.21	16	937.08	0.84
Pure Error	79549.27	54	1473.13	
Cor Total	3683000	80		
Std. Dev.	36.75		R-Squared	0.97
Mean	1894.25		Adj R-Squared	0.97
C.V. %	1.94		Pred R-Squared	0.96
PRESS			Adeq Precision	51.30

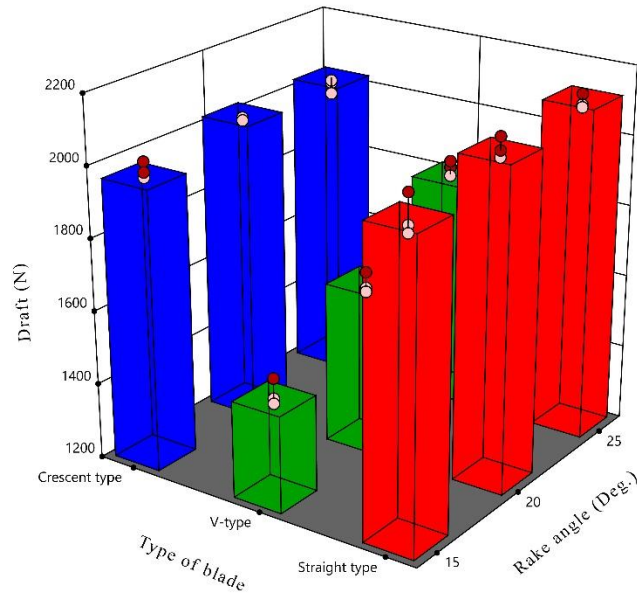
\*\* Significance at 1 % level \* Significance at 5 % level



**Fig. 4.17** The draft requirement for harvesting ginger at 1.5 km h<sup>-1</sup>



**Fig.4.18** The draft requirement for harvesting ginger at 2.0 km h<sup>-1</sup>



**Fig. 4.19** The draft requirement for harvesting ginger at 2.5 km h<sup>-1</sup>

#### 4.11.2 Digging efficiency for harvesting ginger

The effects due to the type of blade, rake angle and forward speed on digging efficiency of harvesting ginger due to the root crop harvester are presented in Appendix-VIII.

A maximum digging efficiency of 89.59 per cent was observed at the rake angle of 25 deg. and forward speed at 2.5 km h<sup>-1</sup> for straight edge blade. Whereas a minimum of 80.40 per cent was observed at the rake angle 15 deg. and at forward speed of 1.5 km h<sup>-1</sup>. An average digging efficiency of 85.58 per cent was observed for straight edge blade at the different combinations of rake angle and forward speed.

In case of V- type blade, the average digging efficiency was observed as 98.23 per cent which was 13.78 per cent higher than the straight edge blade. The maximum digging efficiency of 99.57 per cent was observed at a rake angle of 20 deg. and at forward speed of 2.0 km h<sup>-1</sup>. A digging efficiency of 80.40.70 per cent was observed as minimum at 15 deg. rake angle and at 1.5 km h<sup>-1</sup> forward speed.

Maximum digging efficiency of 90.25 per cent was observed in crescent blade at 25 deg. rake angle and at 2.50 km h<sup>-1</sup> forward speed of operation. Minimum of 83.86 per cent obtained at 15 deg. rake angle and at 1.5 km h<sup>-1</sup>. The mean value of 89.12 per cent was recorded in crescent blade which was 10.0 per cent less than the V-type blade.

Analysis of variance on digging efficiency is presented in Table 4.14. The effects due to operational parameters and its interactions on digging efficiency are also presented.

Among three different type of blades tested, the maximum digging efficiency of 99.57 per cent was noticed in V-type blade at the forward speed of 2.0 km h<sup>-1</sup> and at 20 deg. rake angle (Fig. 4.20). Minimum digging efficiency of 80.40 per cent was observed in straight edge blade at the forward speed of 1.5 km h<sup>-1</sup> and rake angle of 15 deg.

Noticed that the main effects of each factor type of blade (B), rake angle (R) and forward speed (s) were significant at 5 per cent level of significance on digging efficiency. The standard deviation and coefficient of variation were found out as 1.78 and 1.99 per cent with a mean value of 89.63.

Also observed that as the rake angle increased from 15 to 25 deg. digging efficiency for all the types of blades and for all the forward speed of operation was found to increase. Similar trends were observed for both the forward speed 2.0 and 2.5 km h<sup>-1</sup> (Fig.4.21 and 4.22).

It was also seen that the digging efficiency increased as rake angle increased from 15 to 20 deg. the decreased in digging efficiency with increase in 20 to 25 rake angle. The digging efficiency was maximum at the rake angle of 20 deg. for all the combinations of variables. Increase in rake angle of V-type blade from 15 to 20 deg. for forward speed of 2.0 km h<sup>-1</sup> resulted an increase in digging efficiency of 10.0 per cent but showed a decreasing trend when rake angle changed from 20 to 25 deg.

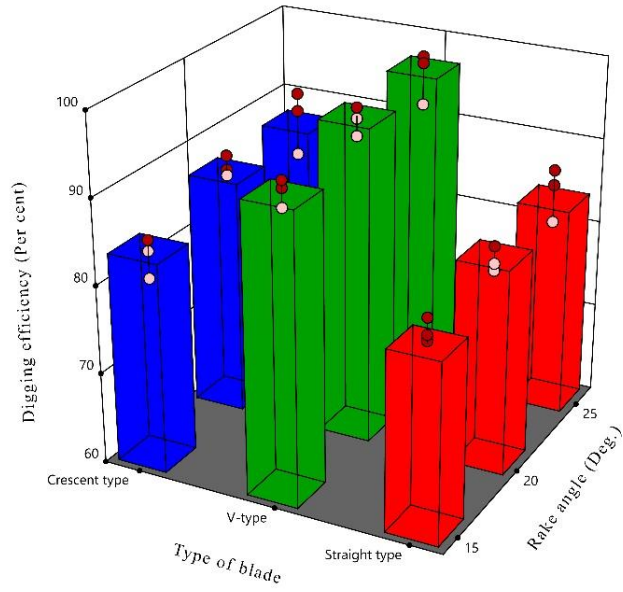
The lower digging efficiency at lower rake angle and lower forward speed might be due to insufficient depth of cut, hence resulted in reduced digging efficiency. For increased rake angle of 25 deg. and at higher forward speed of 2.5 km h<sup>-1</sup>, the

digging efficiency was found decreased. It may be due to higher soil disturbance and lesser blade penetration. At optimum rake angle of 20 deg. and forward speed of 2.0 km h<sup>-1</sup> higher digging efficiency was obtained. This might be due to optimum depth of cut and hence the good tilth. Similar findings were obtained on harvesting root crops by inverted V blade with maximum tuber recovery and minimum damage (Vatsa *et al.*, 1993) and ginger harvester cum elevator (Kawale *et al.*, 2018).

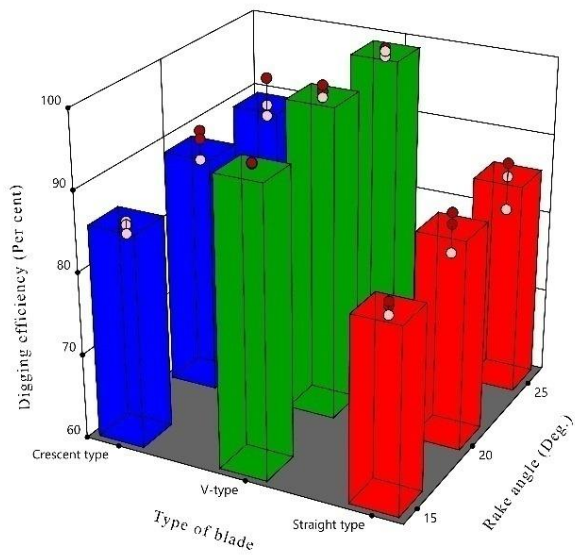
**Table. 4.14. Analysis of variance on digging efficiency of ginger**

Source of variances	Sum of Squares	DF	Mean Square	F Value
Model	2580.23	6	430.04	133.46 **
Type of blades (B)	2300.52	2	1150.26	356.97 **
Rake angle (R)	199.48	2	99.74	30.95 **
Forward speed (S)	80.23	2	40.12	12.45 **
Residual	238.45	74	3.22	
Lack of Fit	31.09	20	1.55	0.40
Pure Error	207.36	54	3.84	
Cor Total	2818.68	80		
Std. Dev.	1.78		R-Squared	0.91
Mean	89.65		Adj R-Squared	0.90
C.V. %	1.99		Pred R-Squared	0.89
PRESS			Adeq Precision	34.68

\*\* Significance at 1 % level \* Significance at 5 % level

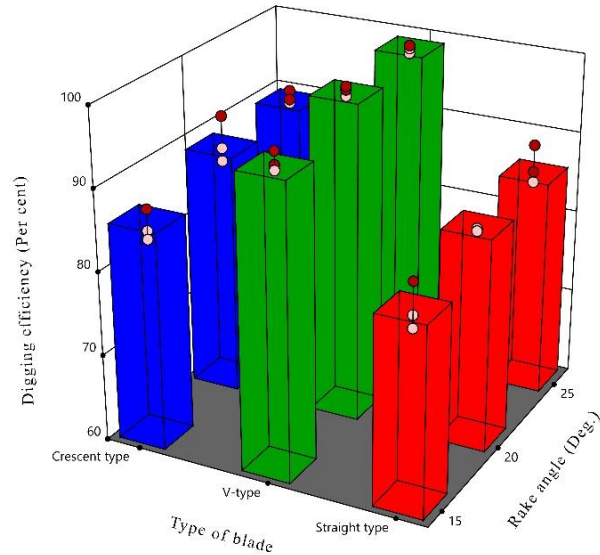


**Fig. 4.20** Digging efficiency for harvesting ginger at 1.5 km h<sup>-1</sup>



**Fig. 4.21** Digging efficiency for harvesting ginger at 2.0 km h<sup>-1</sup>





**Fig. 4.22 Digging efficiency for harvesting ginger at 2.5 km h<sup>-1</sup>**

#### 4.11.3 Per cent damage of ginger

The effects due to the type of blade, rake angle and forward speed on damage of ginger of root crop harvester recorded and analysis of variance is presented in Appendix-VIII, respectively.

For a straight edge type blade, a minimum damage of rhizome of 3.90 per cent was recorded at rake angle 20 deg. and at 2.0 km h<sup>-1</sup> forward speed. The maximum per cent damage of 5.48 was observed at rake angle 15 deg. at forward speed 1.5 km h<sup>-1</sup>. A mean value of 5.17 per cent of damage was recorded for straight edge blade at the different combinations of rake angle and forward speed.

In case of V- type blade, the average damage was observed as 1.80 per cent which was 2 per cent less than the straight edge blade. The maximum per cent of damage of 3.10 per cent was observed at 15 deg. rake angle and at 1.5 km h<sup>-1</sup> speed of operation where as minimum of 0.73 per cent of damage was obtained at 20 deg. rake angle and at 2.0 km h<sup>-1</sup> speed of operation for V-type blade. In case of crescent blade, an average per cent damage of 3.60 was obtained in different combination of rake angle and speed of operations which was 30.00 per cent more than the V-type blade.

The maximum per cent damage of 5.46 per cent was noticed at a rake angle of 15 deg. and at 1.5 km h<sup>-1</sup> speed of operation.

Analysis of variance on per cent damage of rhizome is presented in Table 4.15. The effect due to operational parameters and its interactions on per cent damage of rhizome is also presented. It is noticed that the effect due to type of blade (B), rake angle (R) and forward speed (S) significantly influenced individually on the damage of rhizome at 5 per cent level of significance. The interaction effects of (B x R) and (B x S) significantly influenced the damage of rhizome at 1 per cent level of significance. The standard deviation and coefficient of variation were found out as 0.21 and 6.30 per cent with a mean value of 3.47. It was observed that the increase in rake angle from 15 to 20 deg. decreased per cent damage of rhizome. Further increase in rake angle from 20 to 25 deg. resulted in a slight reduction in damage of rhizome. The similar trend was obtained in all the combinations of variables.

The least damage to rhizome of 0.86 per cent was observed in V-type blade at rake angle of 20 deg. and forward speed of 2.0 km h<sup>-1</sup>. A highest damage of rhizome of 5.22 per cent was obtained in crescent blade at 15 deg. rake angle and at forward speed of 1.5 km h<sup>-1</sup>. It was also observed that as the rake angle increased the per cent damage to the rhizome decreased (Fig.4.23).

Similar trend was observed for all the combinations for the forward speed of 2.0 km h<sup>-1</sup> and 2.5 km h<sup>-1</sup> (Fig. 4.24 and Fig. 4.25). The higher damage of rhizome at lower rake angle might be due to the reduced penetration. Hence more damage of rhizome observed. Again the forward speed also had considerable effect on percentage damage of rhizome. At an optimum speed of 2.0 km h<sup>-1</sup>, there was sufficient depth of cut and optimum soil loosening effect, hence less damage of rhizome was observed. Further increase in forward speed up to 2.5 km h<sup>-1</sup> resulted in higher rhizome damage. This might be due to reduced blade penetration and higher soil disturbance, which in turns resulted in increased damage. Similar findings were reported by Kawale *et al.*, (2018) who reported that the use of inverted V-type blade resulted minimum damage in ginger.

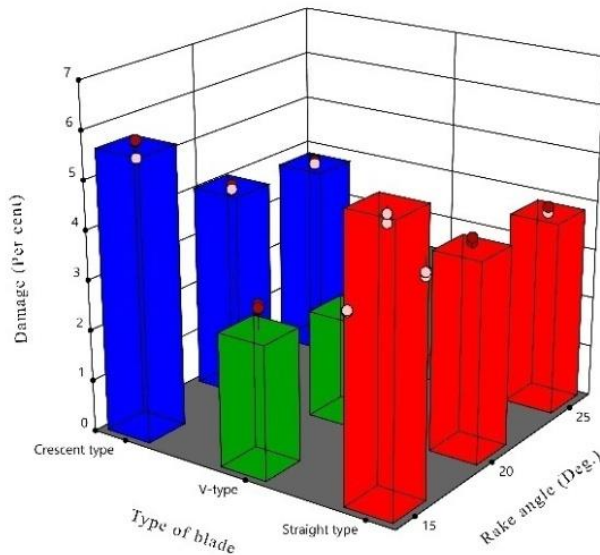
**Table.4.15 Analysis of variance on per cent damage of ginger**

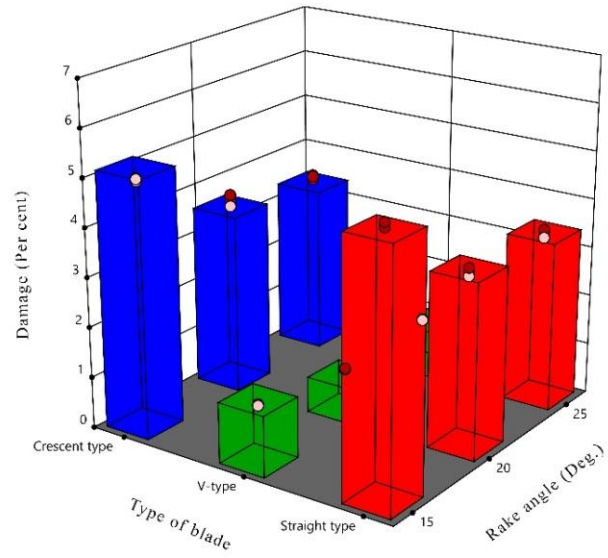
Source of variances	Sum of Squares	DF	Mean Square	F Value
Model	183.00	14	13.07	273.24 **
Type of blades (B)	136.56	2	68.28	1427.32**
Rake angle (R)	27.08	2	13.54	282.99**
Forward speed (S)	8.49	2	4.25	88.75*
B X R	7.02	4	1.76	36.70**
B X S	3.85	4	0.9630	20.13**
Residual	3.16	66	0.0478	
Lack of Fit	2.90	12	0.2416	50.46
Pure Error	0.2585	54	0.0048	
Cor Total	186.16	80		

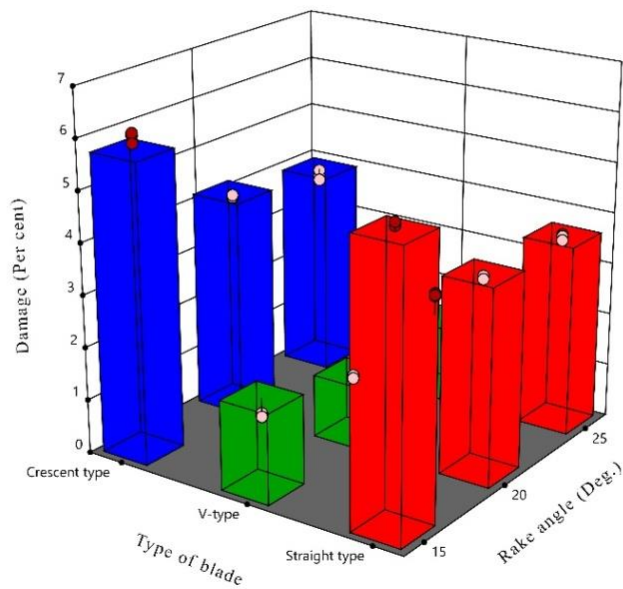
Std. Dev.	0.21	R-Squared	0.98
Mean	3.47	Adj R-Squared	0.97
C.V. %	6.30	Pred R-Squared	0.97
PRESS		Adeq Precision	53.68

\*\* Significance at 1 % level    \* Significance at 5 % level

**Fig. 4.23 Per cent damage of ginger at 1.5 km h<sup>-1</sup>**



**Fig. 4.24** Per cent damage of ginger at 2.0 km h<sup>-1</sup>



**Fig. 4.25** Per cent damage of ginger at 2.5 km h<sup>-1</sup>

#### 4.11.4 Fuel consumption for harvesting ginger

The effects of operational parameters *viz.*, type of blade, rake angle and forward speed on fuel consumption for harvesting ginger using tractor drawn root crop harvester were presented in Appendix-VIII.

For a straight edge blade, a minimum fuel consumption of  $3.74 \text{ l h}^{-1}$  was obtained at a rake angle of 15 deg. and at the forward speed of  $1.5 \text{ km h}^{-1}$ . The maximum fuel consumption of  $5.19 \text{ l h}^{-1}$  was recorded at 25 deg. rake angle and at  $2.5 \text{ km h}^{-1}$  forward speed of operation. An average fuel consumption of  $4.99 \text{ l h}^{-1}$  was noticed for straight edge blade at the different combinations of rake angle and forward speed of operation.

In case of V-type blade the average fuel consumption of  $4.01 \text{ l h}^{-1}$  was observed which 20.64 per cent was less than the straight edge blade. The maximum fuel consumption of  $4.19 \text{ l h}^{-1}$  was at the rake angle of 20 deg. and forward speed of  $2.5 \text{ km h}^{-1}$ . The minimum fuel consumption of  $3.90 \text{ l h}^{-1}$  was noticed at the rake angle of 15 deg. and forward speed of  $2.0 \text{ km h}^{-1}$ .

For crescent blade, the average fuel consumption of  $4.39 \text{ l h}^{-1}$  was recorded which was 9 per cent more than the V-type blade. This blade has got maximum fuel consumption of  $4.57 \text{ l h}^{-1}$  at the rake angle of 25 deg. and at the forward speed of  $2.5 \text{ km h}^{-1}$  where as minimum fuel consumption of  $4.15 \text{ l h}^{-1}$  was noticed at 15 deg. rake angle and the forward speed of  $1.5 \text{ km h}^{-1}$ . Among the different type of blades the less fuel consumption of  $4.01 \text{ l h}^{-1}$  was noticed for V- type blade at the rake angle of 15 deg. and at the forward speed of  $2.0 \text{ km h}^{-1}$ , whereas maximum of  $5.19 \text{ l h}^{-1}$  was noticed in straight edge blade at the rake angle of 25 deg. and at the forward speed of  $2.5 \text{ km h}^{-1}$ .

Analysis of variances on fuel consumption is presented in Table 4.16. The effect due to operational parameters and its interactions on fuel consumption is also presented. It is noticed that effect due to type of blade (B) and forward speed (S) significantly influenced the fuel consumption at 5 per cent level of significance and both variables individually influenced on the fuel consumption. The effect of forward

speed (S) individually on fuel consumption was significantly influenced at 1 per cent level of significance.

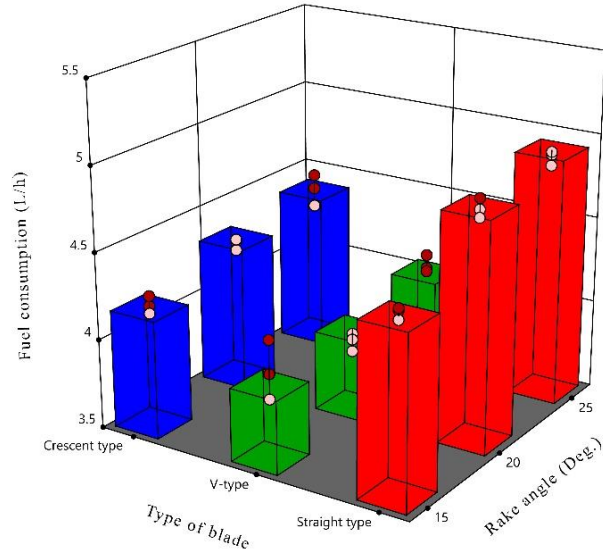
The interaction effects of (B x R) significantly influenced on the fuel consumption at 5 per cent level of significance. The standard deviation and coefficient of variation were found out as 0.085 and 1.95 per cent with a mean value of 4.40.

From Fig.4.26 it was noticed that the increase in rake angle of the harvester increased the fuel consumption of the tractor. The similar trend was obtained for all the combinations of types of blades and forward speed of tractor as shown in Fig 4.27 and 4.28. Similar findings were reported by Gulsoylu *et al.* (2012).

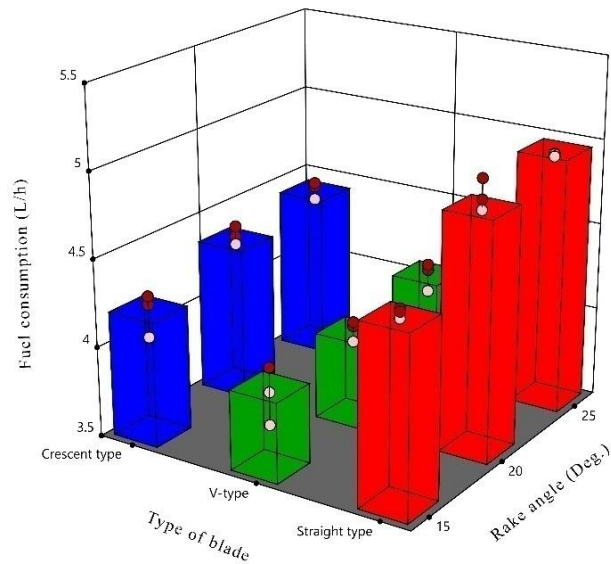
**Table.4.16 Analysis of variance on fuel consumption of tractor for ginger**

Source of variances	Sum of Squares	DF	Mean Square	F Value
Model	9.69	10	0.9690	131.73**
Type of blades (B)	8.24	2	4.12	560.00**
Rake angle (R)	1.02	2	0.5087	69.16**
Forward speed (S)	0.1347	2	0.0673	9.16 *
B X R	0.2990	4	0.0747	10.16**
Residual	0.5149	70	0.0074	
Lack of Fit	0.1311	16	0.0082	1.15
Pure Error	0.3838	54	0.0071	
Cor Total	10.20	80		
Std. Dev.	0.085	R-Squared	0.94	
Mean	4.40	Adj R-Squared	0.94	
C.V. %	1.95	Pred R-Squared	0.93	
PRESS		Adeq Precision	35.40	

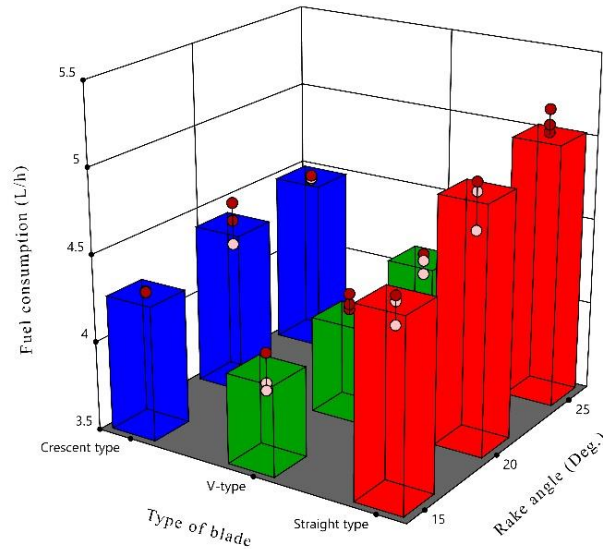
\*\* Significance at 1 % level \* Significance at 5 % level



**Fig. 4.26** Fuel consumption for harvesting ginger at 1.5 km h<sup>-1</sup>



**Fig. 4.27** Fuel consumption for harvesting ginger at 2.0 km h<sup>-1</sup>



**Fig. 4.28 Fuel consumption for harvesting ginger at 2.5 km h<sup>-1</sup>**

#### 4.11.5 Conveying efficiency and soil separation index for ginger

The effect of diameter of crank and spring tension on conveying efficiency and soil separation index for ginger were carried out with the tractor drawn root crop harvester. Results are presented in Appendix- XI.

It was observed that the average conveying efficiency of 83.69 per cent obtained from different combinations of diameter of crank and spring tension. The maximum conveying efficiency of 87.07 per cent was noticed for 80 mm diameter of crank at 1600 N m<sup>-1</sup> spring tension. The least conveying efficiency of 75.95 per cent was noticed for 40 mm diameter of crank at 800 N m<sup>-1</sup> spring tension. The conveying efficiency was increased by 13.88 per cent when the spring tension increased from 800 to 1600 N m<sup>-1</sup> (Fig 4.30). The standard deviation and coefficient of variation were found out as 1.35 and 1.62 per cent with a mean value of 83.69.

From Table 4.17, the individual variables like crank diameter (C) and spring tension (T) on conveying efficiency was significantly influenced at 1 per cent level of significance. It is seen that the average soil separation index was found out as 68.66 per



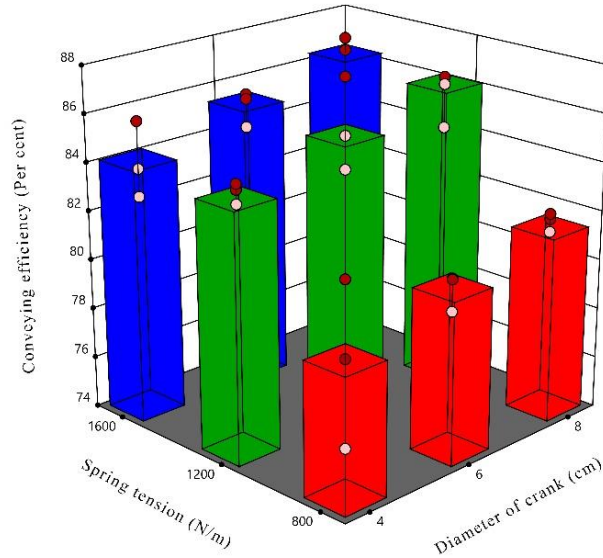
cent from different spring tensions and diameter of crank. The maximum soil separation index was noticed for 80 mm diameter of crank followed by 60 mm and 40 mm respectively. The increase in separating index by 10.29 per cent was observed as the diameter of crank increased from 40 to 80 mm, and 800 to 1600 N m<sup>-1</sup> (Fig 4.31). The standard deviation and coefficient of variation were found out as 1.33 and 1.94 per cent with a mean value of 68.66 per cent.

The individual and combined effects of operational parameters on soil separation index were analyzed statistically and is presented in Table 4.18. The table showed that, the effect of diameter of crank (C) and spring tension (T) significantly influenced the soil separation index at 5 per cent level of significance and both variables individually influenced the soil separation index. Similar results reported for ginger and turmeric rhizomes by Wajire *et al.* (2018).

**Table.4.17 Analysis of variance on conveying efficiency in ginger**

Source	Sum of Squares	DF	Mean Square	F Value
Model	156.84	4	39.21	18.21**
Diameter of crank (A)	20.85	2	10.43	7.14**
Spring tension (B)	135.98	2	67.99	29.29 **
Residual	40.28	22	1.83	
Lack of Fit	1.97	4	0.49	0.23
Pure Error	38.30	18	2.13	
Cor Total	197.11	26		
Std. Dev.	1.35		R-Squared	0.79
Mean	83.69		Adj R-Squared	0.75
C.V. %	1.62		Pred R-Squared	0.69
PRESS	60.6		Adeq Precision	12.03

\*\* Significance at 1 % level \* Significance at 5 % level

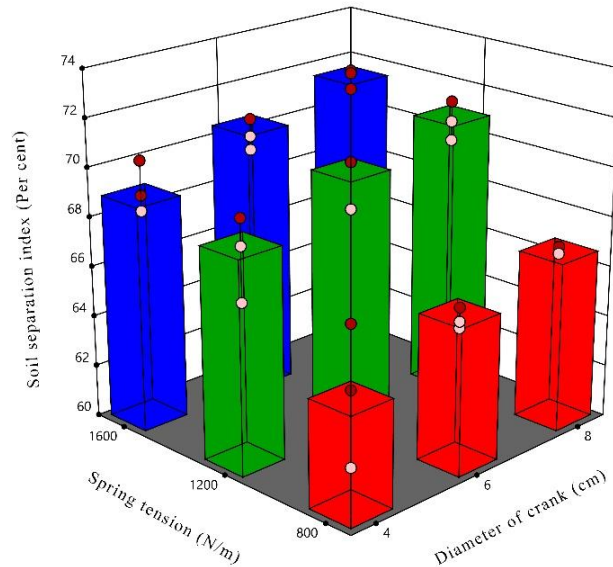


**Fig.4.29** The conveying efficiency for ginger

**Table.4.18** Analysis of variance on soil separation index in ginger

Source	Sum of Squares	DF	Mean Square	F Value
Model	152.28	4	38.07	21.44 **
Diameter of crank(A)	29.83	2	14.92	8.40 **
Spring tension (B)	122.45	2	61.22	34.48**
Residual	39.07	22	1.78	
Lack of Fit	2.75	4	0.68	0.34
Pure Error	36.32	18	2.02	
Cor Total	191.34	26		
Std. Dev.	1.33		R-Squared	0.79
Mean	68.66		Adj R-Squared	0.75
C.V. %	1.94		Pred R-Squared	0.69
PRESS	58.84		Adeq Precision	12.76

\*\* Significance at 1 % level \* Significance at 5 % level



**Fig.4.30 The soil separation index for ginger**

#### 4.12 OPTIMIZATION FOR DIGGING UNIT FOR GINGER

Numerical optimization technique was adopted to get optimum levels of independent variables for the designed and tested models using Design Expert 12.0.4 version software. Optimization constraints of experiments are presented in Table 4.17 and best optimal solutions were presented in the Table 4.18.

##### 4.12.1 Desirability index for digging unit

The highest desirability index of 0.84 was observed at a forward speed of 2.0 km h<sup>-1</sup> with 20 deg. rake angle for V-type blade (Fig 4.29). Hence, this treatment combination of 2.0 km h<sup>-1</sup>, 20 deg. and V-type blade was selected as the optimum for further evaluation of soil separator unit.

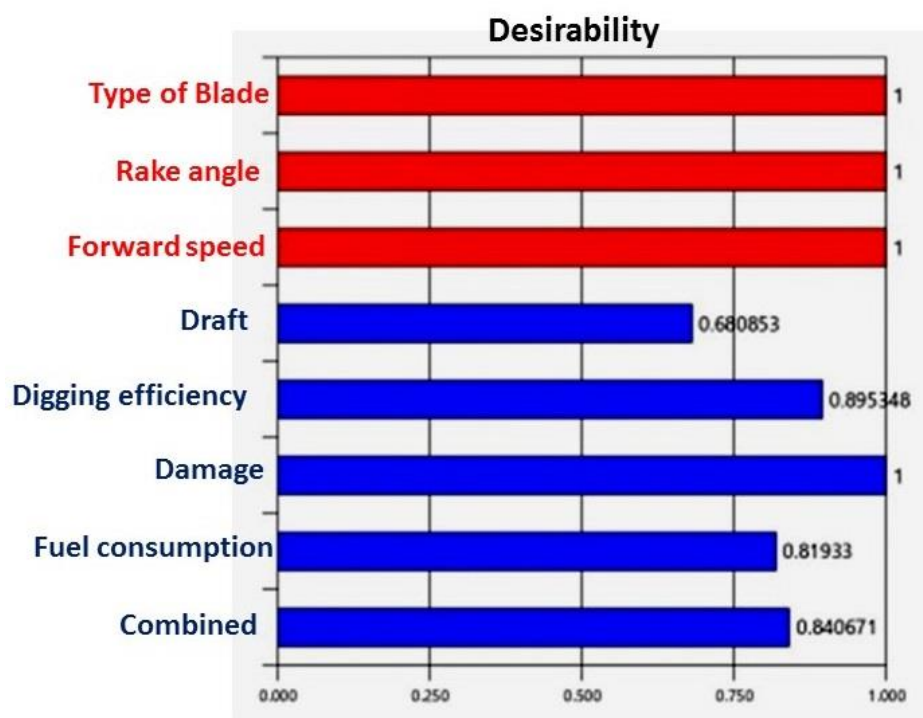


Fig 4.31 Desirability index for optimized digging unit for ginger

Table 4.19 Numerical optimization constraints on digging unit of ginger

Name	Goal	Lower Limit	Upper Limit	Lower Weight	Upper Weight	Importance
Type of blade	is in range	Straight edge	Crescent type	1	1	3
Rake angle	is in range	15	25	1	1	3
Forward speed	is in range	1.5	2.5	1	1	3
Draft	minimize	1374.31	2176.33	1	1	3
Digging efficiency	maximize	80.40	100.57	1	1	3
Per cent of Damage	minimize	0.85	6.1	1	1	3
Fuel consumption	minimize	3.74	5.19	1	1	3

Table 4.20. Best optimal solutions of digging unit for harvesting ginger

Sl. No.	Variables	Optimal Values
1	Tool geometry	V – Type
2	Rake angle	20deg.
3	Forward speed	2.0 km h <sup>-1</sup>

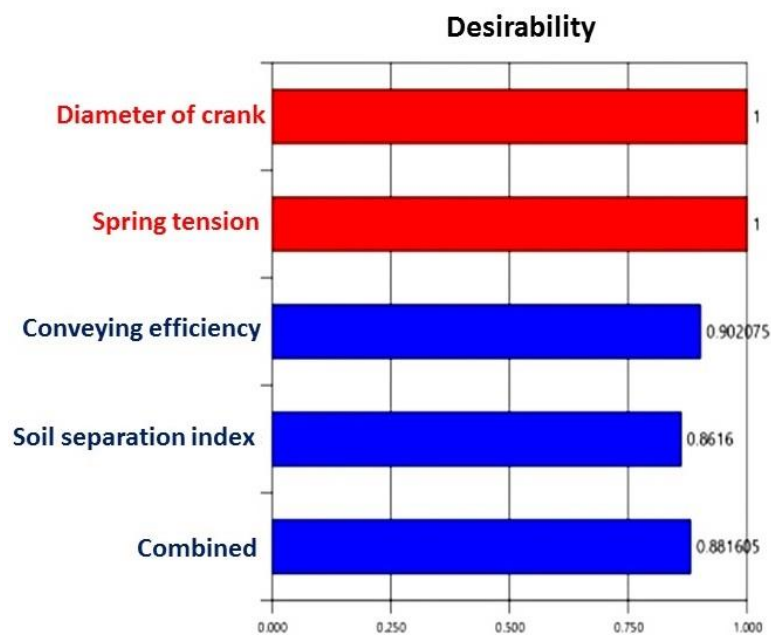
#### 4.13. OPTIMIZATION FOR SOIL SEPARATOR UNIT

The soil separator unit of the root crop harvester was evaluated based on the optimized parameters obtained for digging unit. Further the soil separator unit was tested with different treatment combinations diameter of crank *viz.*, 40, 60 and 80 mm) and spring tension *viz.*, 800, 1200 and 1600 N m<sup>-1</sup>. The operational parameters of the soil separator unit were optimized based on the performance parameters of the soil separator unit such as soil separation index and conveying efficiency.

Numerical optimization technique was adopted to get optimum levels of independent variables for the designed and tested models using ‘Design Expert 12.0.4’ version software. Optimization constraints of experiments are presented in Table 4.21 and best optimal solutions were presented in the Table 4.22.

##### 4.13.1 Desirability index for soil separator unit

The highest desirability index of 0.881 was observed at a spring tension 1600 N m<sup>-1</sup> with 8 cm diameter of crank (Fig 4.32). Hence, this treatment combination of 8 cm diameter of crank and 1600 N m<sup>-1</sup> spring tension was chosen as the optimum for further field performance evaluation of root crop harvester.



**Fig 4.32 Desirability index of soil separator unit for ginger**

**Table 4.21 Optimization constraints for soil separator unit for ginger**

Name	Goal	Lower Limit	Upper Limit	Lower Weight	Upper Weight	Importance
Diameter of crank	is in range	4	8	1	1	3
Spring tension	is in range	800	1600	1	1	3
Conveying efficiency	maximize	75.95	87.55	1	1	3
Soil separation index	maximize	61.60	73.21	1	1	3

**Table 4.22. Best optimal solutions of soil separator unit for harvesting ginger**

Sl. No.	Variables	Optimal Values
1	Tool geometry	V – type
2	Diameter of crank	8 cm
3	Spring tension	1600 N m <sup>-1</sup>

#### 4.14 TESTING AND OPTIMIZATION OF THE DEVELOPED ROOT CROP HARVESTER FOR TURMERIC

Similarly the tractor drawn root crop harvester was tested in field condition to determine the optimum operational parameters for harvesting turmeric. The parameters selected for optimization include three types of blade *viz.*, straight edge, V-type and crescent, three rake angles *viz.*, 15, 20, 25 deg. and three forward speeds *viz.*, 1.5, 2.0 and 2.5 km h<sup>-1</sup> respectively. The effect of operational parameters was studied to evaluate the performance of root crop harvester in terms of draft, digging efficiency, damage of rhizome and fuel consumption.

##### 4.14.1 The draft requirement for turmeric

The effect of type of blade, rake angle and forward speed on draft of root crop harvester are presented in Appendix-IX.

The minimum draft of 1390.06 N was obtained for straight edge type blade at a rake angle of 15 deg. when the harvester was operated at a forward speed of 1.5 km h<sup>-1</sup>. The maximum draft of 2192.08 N was recorded for a forward speed of 1.5 km h<sup>-1</sup>.

<sup>1</sup>and 25 deg. rake angle. An average draft of 2103.37 N was observed for straight edge blade at different combinations of rake angle and forward speed.

In case of V- type blade, an average draft was recorded to be 1646.01 N which was 24.25 per cent lesser than the straight edge blade. The maximum draft of 1883.87 N was recorded at the rake angle of 25 deg. and forward speed of 2.5 km h<sup>-1</sup>. For crescent type of blade, the maximum draft of 2106.08 N was recorded at the rake angle of 20 deg. and forward speed of 2.0 km h<sup>-1</sup>. An average draft of 2026 N was recorded which is 19 per cent more than the V-type blade.

Analysis of variances on draft is presented in Table 4.23. The effect due to operational parameters and its interactions on draft is also presented.

It is noticed that type of blade (B), rake angle (R) and forward speed (S) had significant effect on draft at 5 per cent level of significance. The interaction effects of (B x R) are significantly influenced the draft at 5 per cent level of significance. The standard deviation and coefficient of variation were found out as 36.75 and 1.92 per cent with a mean value of 1910.00 N.

From the Fig. 4.33, it is obvious that, as the rake angle increased from 15 to 25 deg. the draft also increased for all the types of blades at the forward speed of 1.5 km h<sup>-1</sup>. The minimum draft was noticed for V-type blade as compared to straight edge and crescent type blades. A draft of 22.80 per cent less than the straight edge blade at the rake angle of 15 deg. and forward speed of 1.5 km h<sup>-1</sup> was obtained for V-type blade.

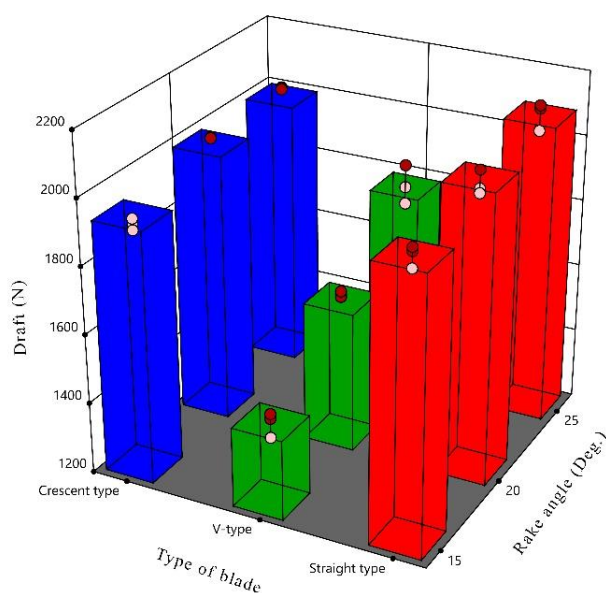
Similar trend was noticed for both the forward speed of 2.0 and 2.5 km h<sup>-1</sup> (Fig. 4.34 and 4.35). It may be due to different regimes of soil failure, different forces acting on the soil and also the blade geometry parameters.

These results are in accordance with the results of V-type blade when used in onion digger by (Khuraet *et al.*, 2011) and results of root crop harvester for turmeric and ginger by (Wajire *et al.*, 2018).

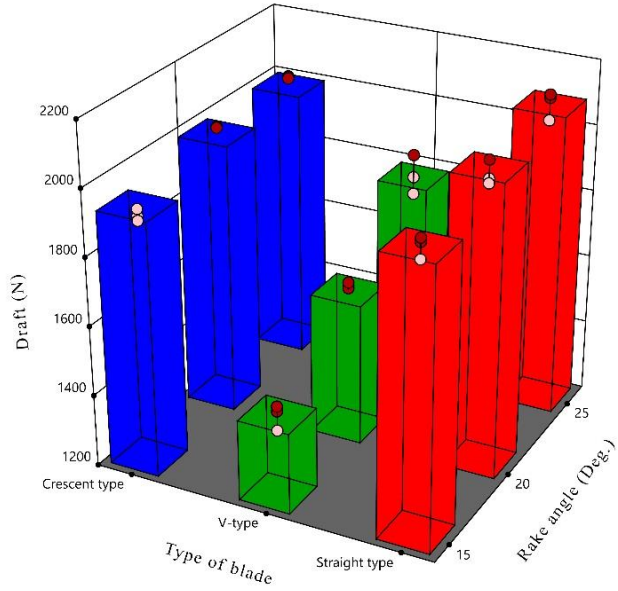
**Table. 4.23 Analysis of variance on draft for harvesting turmeric**

Source of variances	Sum of Squares	DF	Mean Square	F Value
Model	3589000	10	358900	265.72 **
Type of blades (B)	2924000	2	1462000	1082.55 **
Rake angle (R)	382300	2	191200	141.54 **
Forward speed (S)	257100	2	12612.40	9.34 *
B X R	257100	4	64266.56	47.58**
Residual	94542.48	70	1350.61	
Lack of Fit	14993.21	16	937.08	0.84
Pure Error	79549.27	54	1473.13	
Cor Total	3683000	80		
Std. Dev.	36.75		R-Squared	0.97
Mean	1910.0		Adj R-Squared	0.97
C.V. %	1.92		Pred R-Squared	0.96
PRESS			Adeq Precision	51.30

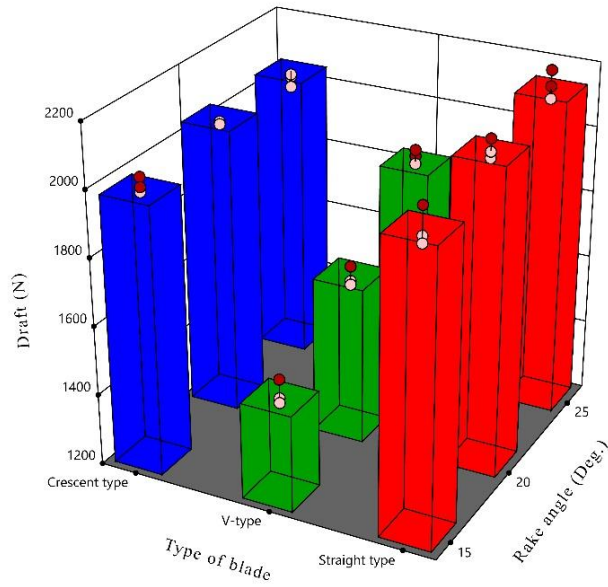
\*\* Significance at 1 % level \* Significance at 5 % level

**Fig. 4.33 Draft requirement for harvesting turmeric at 1.5 km h<sup>-1</sup>**





**Fig. 4.34** Draft requirement for harvesting turmeric at 2.0 km h<sup>-1</sup>



**Fig.4.35** Draft requirement for harvesting turmeric at 2.5 km h<sup>-1</sup>

#### 4.14.2 Digging efficiency for harvesting turmeric

The effects due to type of blade, rake angle and forward speed on digging efficiency of harvesting turmeric due to the root crop harvester are presented in Appendix-IX.

A maximum digging efficiency of 88.66 per cent was observed at the rake angle of 25 deg. and forward speed at 2.5 km h<sup>-1</sup> for straight edge blade. Whereas a minimum of 82.18 per cent was observed in rake angle 15 deg. at forward speed of 1.5 kmh<sup>-1</sup>. An average digging efficiency of 86.33 per cent was observed for straight edge blade at the different combinations of rake angle and forward speed.

Average digging efficiency was observed as 99.14 per cent which was 14.67 per cent higher than the straight edge blade for V- type blade. The maximum digging efficiency of 99.60 per cent was observed at a rake angle of 25 deg. and at forward speed of 2.0 km h<sup>-1</sup>. A minimum digging efficiency of 93.16 per cent was observed at 15 deg. rake angle and at 1.5 km h<sup>-1</sup> forward speed.

Maximum digging efficiency of 91.25 per cent was observed in crescent blade at 25 deg. rake angle and at 2.5 km h<sup>-1</sup> forward speed of operation. Whereas minimum of 82.15 per cent obtained at 15 deg. rake angle and at 1.5 km h<sup>-1</sup>. The mean value of 88.63 per cent was recorded in crescent blade which was 12.0 per cent less than the V-type blade.

Analysis of variance on digging efficiency is presented in Table 4.24. The effects due to operational parameters and its interactions on digging efficiency are also presented. It was also observed that among the different type of blade the maximum digging efficiency of 99.60 per cent was noticed in V-type blade at the forward speed of 2.0 km h<sup>-1</sup> and at 20 deg. rake angle (Table 4.24 and Fig. 4.36). Minimum digging efficiency of 82.18 per cent was observed in straight edge blade at the forward speed of 1.5 km h<sup>-1</sup> and rake angle of 15 deg.

From Table 4.24, it was observed that the main effects of each factor type of blade (B), rake angle (R) and forward speed (s) were significant at 5 per cent level of

significance on digging efficiency. The standard deviation and coefficient of variation were found out as 1.79 and 1.97 per cent with a mean value of 90.78.

Also observed that as the rake angle increased from 15 to 25 deg. digging efficiency for all the types of blades and for all the forward speed of operation was found to be increased (Fig.4.30). Similar trends were observed for both the forward speed 2.0 and 2.5 km h<sup>-1</sup> (Fig.4.37 and 4.38).

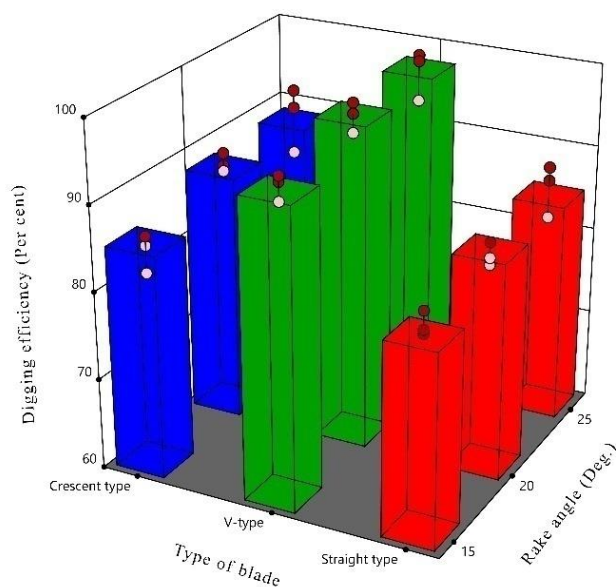
It was also seen that the digging efficiency increased as rake angle increased from 15 to 20 deg. but decreased with increase in rake angle. The digging efficiency was maximum at the rake angle of 20 deg. for all the combinations of variables. Increase in rake angle of V-type blade from 15 to 20 deg. for forward speed of 2.0 km h<sup>-1</sup> resulted in an increase digging efficiency of 9.4 per cent but showed a decreasing trend when rake angle changed from 20 to 25 deg.

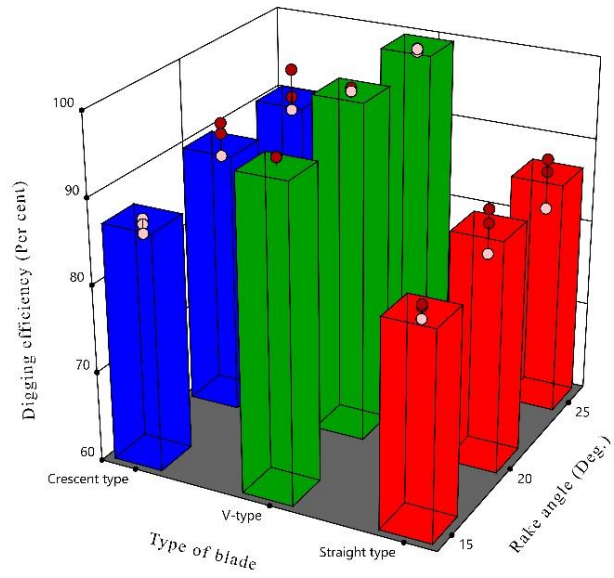
The lower digging efficiency at lower rake angle and lower forward speed might be due to insufficient depth of cut, hence resulted in reduced digging efficiency. For increased rake angle of 25 deg. and at higher forward speed of 2.5 km h<sup>-1</sup>, the digging efficiency was found decreased. It may be due to higher soil disturbance and lesser blade penetration. At optimum rake angle of 20 deg. and forward speed of 2.0 km h<sup>-1</sup> higher digging efficiency was obtained. This might be due to optimum depth of cut and hence the good tilth. Similar findings were obtained on harvesting root crops by inverted V blade with maximum tuber recovery and minimum damage (Vatsa *et al.*, 1993) and for ginger harvester cum elevator by (Kawale *et al.*, 2018).

**Table.4.24 Analysis of variance on digging efficiency for turmeric**

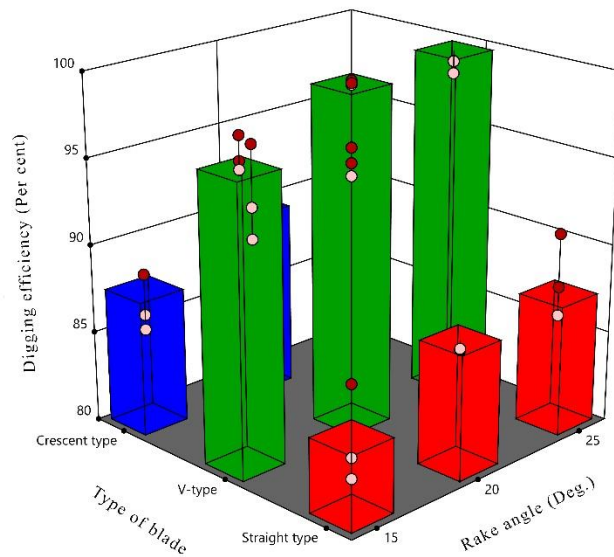
Source of variances	Sum of Squares	DF	Mean Square	F Value
Model	2370.28	6	395.05	123.68 **
Type of blades (B)	2131.44	2	1065.72	333.65 **
Rake angle (R)	173.35	2	86.67	27.13 **
Forward speed (S)	65.49	2	32.75	10.25 **
Residual	236.37	74	3.19	
Lack of Fit	34.39	20	1.72	0.45
Pure Error	201.98	54	3.74	
Cor Total	2606.64	80		
Std. Dev.	1.79		R-Squared	0.90
Mean	90.78		Adj R-Squared	0.90
C.V. %	1.97		Pred R-Squared	0.89
PRESS			Adeq Precision	33.28

\*\* Significance at 1 % level \* Significance at 5 % level

**Fig. 4.36 Digging efficiency for harvesting turmeric at 1.5 km h<sup>-1</sup>**



**Fig. 4.37 Digging efficiency for harvesting turmeric at 2.0 km h<sup>-1</sup>**



**Fig.4.38 Digging efficiency for harvesting turmeric at 2.5 km h<sup>-1</sup>**

#### 4.14.3 Per cent damage of turmeric

The effects of type of blade, rake angle and forward speed on per cent damage of turmeric due to the root crop harvester were recorded and is presented in Appendix-IX.

For a straight edge blade, a minimum damage rhizome of 4.5 per cent was recorded at rake angle 20 deg. and at 2.0 km h<sup>-1</sup> forward speed. The maximum per cent damage of 6.8 was observed at rake angle 15 deg. and forward speed 1.5 km h<sup>-1</sup> of operation. A mean value of 4.7 per cent of damage was recorded for straight edge blade at the different combinations of rake angle and forward speed.

In case of V-type blade, the average damage was observed as 2.09 per cent which was 2.70 per cent less than the straight edge blade. The maximum per cent of damage of 4.35 was observed at 15 deg. rake angle and at 1.5 km h<sup>-1</sup> speed of operation where as minimum of 0.74 per cent of damage was obtained at 20 deg. rake angle and at 2.0 km h<sup>-1</sup> speed of operation for V-type blade. An average per cent damage of 6.77 for crescent blade was obtained in different combination of rake angle and speed of operations which was 70 per cent more than the V-type blade. The maximum per cent damage of 7.3 per cent was noticed at a rake angle of 15 deg. and at 1.5 km h<sup>-1</sup> speed of operation.

Analysis of variance on per cent damage of rhizome is presented in Table 4.25. The effect due to operational parameters and its interactions on per cent damage of rhizome is also presented. It is noticed that the effect due to type of blade (B) rake angle (R) and forward speed (S) significantly influenced individually on the damage of rhizome at 5 per cent level of significance.

The interaction effects of (B x R) and (B x S) significantly influenced the damage of rhizome at 1 per cent level of significance. The standard deviation and coefficient of variation were found out as 0.26 and 5.74 per cent with a mean value of 4.61 per cent.

It was observed that as the rake angle increased from 15 to 20 deg. the per cent damage of rhizome was found decreased. Further increase in rake angle from 20 to 25

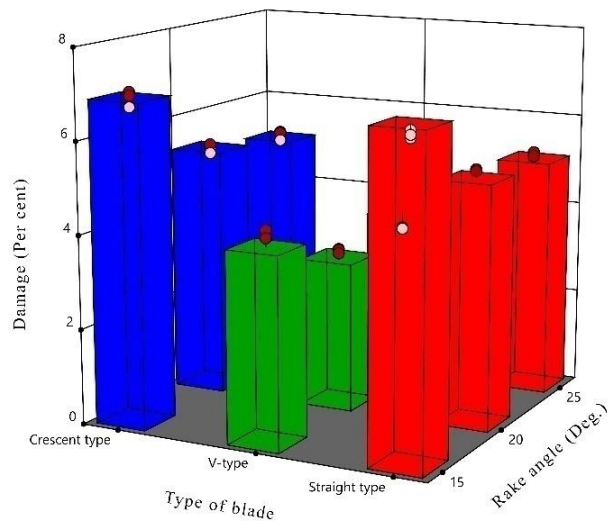
deg. there was a slight reduction in damage of rhizome. The similar trend was obtained in all the combinations of variables. The least damage to rhizome of 0.74 per cent was observed in V-type blade at rake angle of 20 deg. and forward speed of 2.0 km h<sup>-1</sup>. A highest damage of rhizome of 7.3 per cent was obtained in crescent blade at 15 deg. rake angle and at forward speed of 1.5 km h<sup>-1</sup>. It was also observed that as the rake angle increased the per cent damage to the rhizome decreased (Fig.4.39).

Similar trend was observed for all the combinations for the forward speed of 2.0 km h<sup>-1</sup> and 2.5 km h<sup>-1</sup> (Fig. 4.40 and Fig. 4.41). The higher damage of rhizome at lower rake angle might be due to the reduced penetration. Hence more damage of rhizome was observed. Again the forward speed also had considerable effect on percentage damage of rhizome. At optimum speed of 2.0 km h<sup>-1</sup>, there was sufficient depth of cut and optimum soil loosening effect, hence less damage of rhizome was found. Further increase in forward speed of 2.5 km h<sup>-1</sup> resulted in higher rhizome damage. This might be due to reduced blade penetration and higher soil disturbance, which in turn in increased damage. Similar findings were reported by Vatsa *et al.*, (1993) who reported that the use of inverted V-type blade resulted minimum damage in potato and reported for turmeric and ginger by Wajire *et al.* (2018).

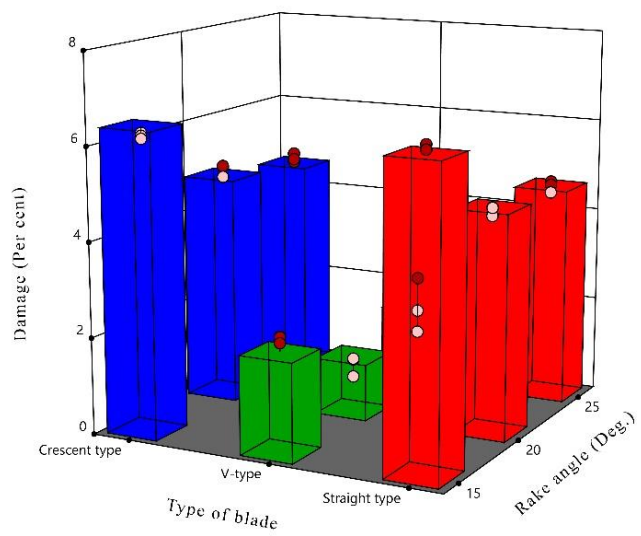
**Table. 4.25 Analysis of variance on per cent of damage of turmeric**

Source	Sum of Squares	DF	Mean Square	F Value
Model	212.94	14	15.21	217.41 **
Type of blades (B)	155.15	2	77.57	1108.84 **
Rake angle (R)	31.78	2	15.89	227.11 **
Forward speed (S)	13.61	2	6.81	97.28 **
B X R	5.00	4	1.25	17.87**
B X S	7.41	4	1.85	26.47 **
Residual	4.62	66	0.0700	
Lack of Fit	3.31	12	0.2757	11.37
Pure Error	1.31	54	0.0242	
Cor Total	217.56	80		
Std. Dev.	0.26	R-Squared	0.97	
Mean	4.61	Adj R-Squared	0.97	
C.V. %	5.74	Pred R-Squared	0.96	
PRESS		Adeq Precision	50.63	

\*\* Significance at 1 % level \* Significance at 5 % level

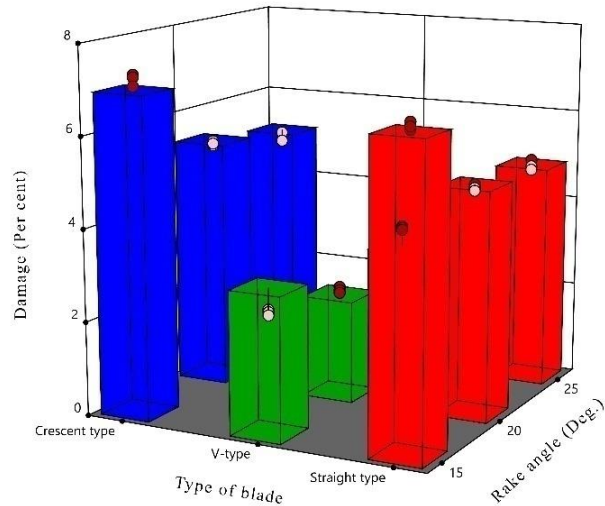


**Fig. 4.39** Per cent damage of turmeric at 1.5 km h<sup>-1</sup>



**Fig. 4.40** Per cent damage of turmeric at 2.0 km h<sup>-1</sup>





**Fig.4.41 Per cent damage of turmeric at 2.5 km h<sup>-1</sup>**

#### **4.14.4 Fuel consumption for harvesting turmeric**

The effects of operational parameters *viz.*, type of blade, rake angle and forward speed on fuel consumption for harvesting turmeric using tractor drawn root crop harvester is presented in Appendix-IX.

For a straight edge blade, a minimum fuel consumption of 4.5 l h<sup>-1</sup> was obtained at a rake angle of 15 deg. and at the forward speed of 1.5 km h<sup>-1</sup>. The maximum fuel consumption of 5.01 l h<sup>-1</sup> was recorded at 25 deg. rake angle and at 2.5 km h<sup>-1</sup> forward speed of operation. An average fuel consumption of 4.86 l h<sup>-1</sup> was noticed for straight edge blade at the different combinations of rake angle and forward speed of operation.

In case of V-type blade the average fuel consumption of 4.09 l h<sup>-1</sup> was observed which was 16.85 per cent less than the straight edge blade. The maximum fuel consumption of 4.45 l h<sup>-1</sup> at the rake angle of 25 deg. and forward speed of 2.5 km h<sup>-1</sup>. The minimum fuel consumption of 4.0 l h<sup>-1</sup> was noticed at the rake angle of 15 deg. and forward speed of 1.5 km h<sup>-1</sup>.

For crescent blade, the average fuel consumption of  $5.08 \text{ l h}^{-1}$  was recorded which was 10.00 per cent more than the V-type blade. This blade has got maximum fuel consumption of  $5.57 \text{ l h}^{-1}$  at the rake angle of 25 deg. and at the forward speed of  $2.5 \text{ km h}^{-1}$  where as minimum fuel consumption of  $5.07 \text{ l h}^{-1}$  was noticed at 15 deg. rake angle and the forward speed of  $2.0 \text{ km h}^{-1}$ . Among the different type of blades the less fuel consumption of  $4.0 \text{ l h}^{-1}$  was noticed for V-type blade at the rake angle of 20 deg. and at the forward speed of  $2.0 \text{ km h}^{-1}$ , whereas maximum of  $5.57 \text{ l h}^{-1}$  was noticed in crescent type blade at the rake angle of 25 deg. and at the forward speed of  $2.5 \text{ km h}^{-1}$ .

Analysis of variances on digging efficiency is presented in Table 4.26. The effect due to operational parameters and its interactions on digging efficiency is also presented.

The table showed that, the effect of type of blade (B) and forward speed (S) significantly influenced the fuel consumption at 5 per cent level of significance and both variables individually influenced on the fuel consumption. The effect of forward speed (S) individually on fuel consumption was significantly influenced at 1 per cent level of significance.

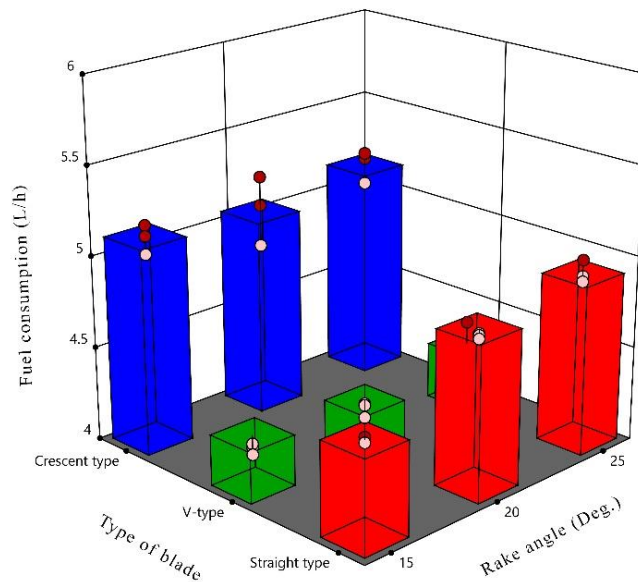
Interaction effects of (B x R) significantly influenced fuel consumption at 5 per cent level of significance. The standard deviation and coefficient of variation were found out as 0.089 and 2.07 per cent with a mean value of  $4.47 \text{ l h}^{-1}$ .

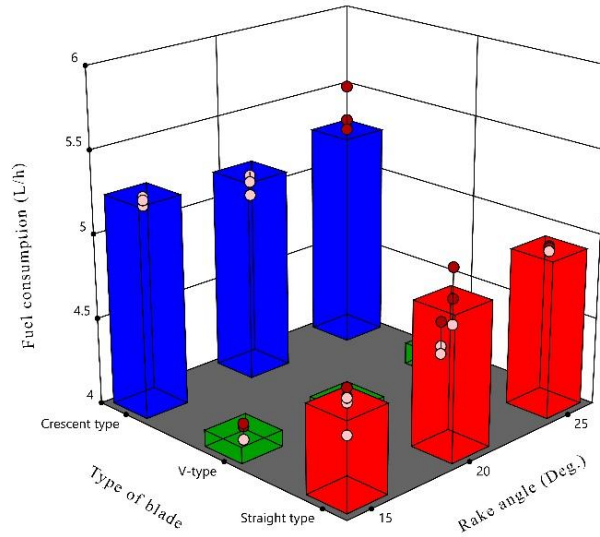
From Fig.4.2 it was noticed that the increase in rake angle of the harvester increased the fuel consumption of the tractor. The similar trend was obtained for all the combinations of types of blades and forward speed of tractor as shown in Fig 4.43 and 4.44. Similar findings were reported by Gulsoylu *et al.* (2012).

**Table. 4.26 Analysis of variance on fuel consumption for harvesting turmeric**

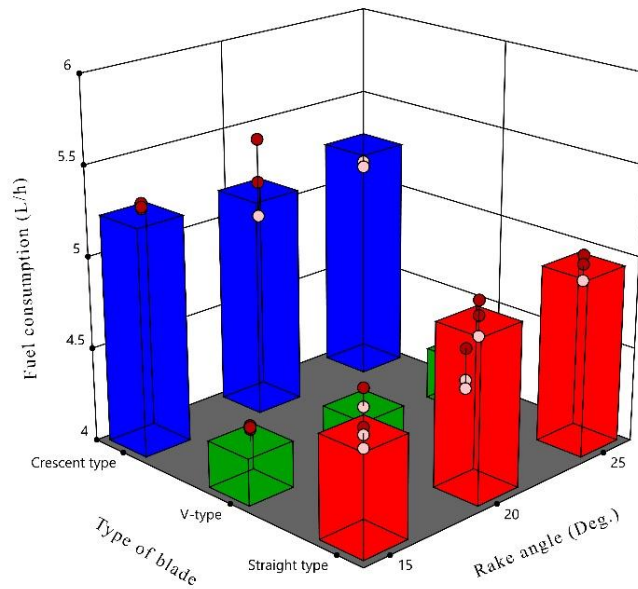
Source of variances	Sum of Squares	DF	Mean Square	F Value
Model	9.69	10	0.9693	120.88 **
Type of blades (B)	8.24	2	4.12	513.64 **
Rake angle (R)	1.02	2	0.5105	63.66 **
Forward speed (S)	0.1363	2	0.0682	8.50 *
B X R	0.2984	4	0.0746	9.30 **
Residual	0.5613	70	0.0080	
Lack of Fit	0.1309	16	0.0082	1.03
Pure Error	0.4304	54	0.0080	
Cor Total	10.25	80		
Std. Dev.	0.089	R-Squared	0.94	
Mean	4.47	Adj R-Squared	0.93	
C.V. %	2.01	Pred R-Squared	0.92	
PRESS		Adeq Precision	33.92	

\*\* Significance at 1 % level \* Significance at 5 % level

**Fig. 4.42 Fuel consumption for harvesting turmeric at 1.5 km h<sup>-1</sup>**



**Fig. 4.43** Fuel consumption for harvesting turmeric at 2.0 km h<sup>-1</sup>



**Fig. 4.44** Fuel consumption for harvesting turmeric at 2.5 km h<sup>-1</sup>

#### 4.14.5 Conveying efficiency and soil separation index for turmeric

The effect of diameter of crank and spring tension on conveying efficiency for turmeric were carried out with the tractor drawn root crop harvester and the results are presented in Appendix- XII.

It was observed that the average conveying efficiency of 84.64 per cent obtained from different combinations of diameter of crank and spring tension. The maximum conveying efficiency of 89.71 per cent was noticed for 80 mm diameter of crank at 1600 N m<sup>-1</sup> spring tension. The least conveying efficiency of 76.99 per cent was noticed for 40 mm diameter of crank at 800 N m<sup>-1</sup> spring tension. The increase of conveying efficiency by 15.20 per cent was found as the crank diameter and spring tension increased from 40 to 80 mm and 800 to 1600 N m<sup>-1</sup> respectively (Fig. 4.46).

From Table 4.29, the individual variables like diameter of crank (C) and spring tension (T) on conveying efficiency was significantly influenced at 5 per cent level of significance. The standard deviation and coefficient of variation were found out as 1.43 and 1.69 per cent with a mean value of 84.64 per cent.

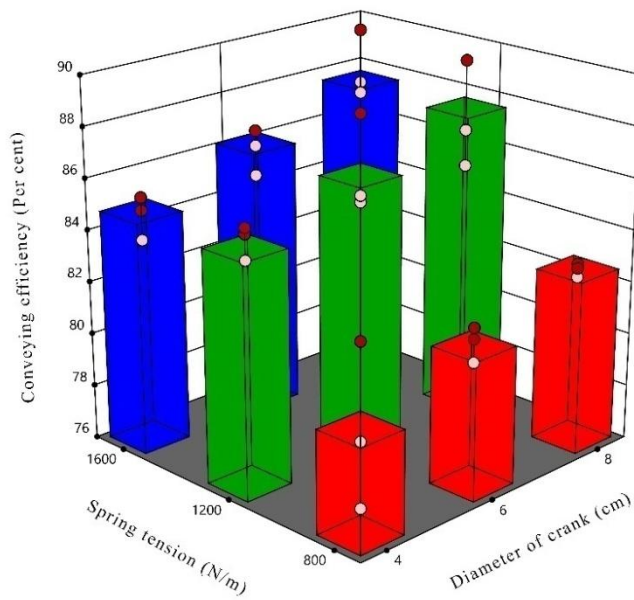
It was also seen that the average soil separation index was found out 63.86 per cent from different spring tensions and diameter of crank. The maximum soil separation index was noticed at 80 mm diameter of crank followed by 60 and 40 mm respectively. The increase in separating index by 15 per cent was found as the diameter of crank increased from 40-80 mm and 800-1600 N m<sup>-1</sup> respectively (Fig. 4.47).

The individual and combined effects of operational parameters on soil separation index were analyzed statistically and is presented in Table 4.30. The results showed that, the effect of diameter of crank (C) and spring tension (T) significantly influenced the soil separation index at 5 per cent level of significance and both variables individually influenced the soil separation index. The standard deviation and coefficient of variation were found out as 1.42 and 2.22 per cent respectively with a mean value of 63.86 per cent.

**Table.4.27 Analysis of variance onconveying efficiency in turmeric**

Source	Sum of Squares	DF	Mean Square	F Value
Model	183.99	4	46.00	22.61 **
Diameter of crank(A)	34.56	2	17.28	8.49 **
Spring tension (B)	149.43	2	74.72	36.73 **
Residual	44.76	22	2.03	
Lack of Fit	1.97	4	0.49	0.93
Pure Error	42.79	18	2.38	
Cor Total	228.75	26		
Std. Dev.	1.43	R-Squared	0.80	
Mean	84.64	Adj R-Squared	0.76	
C.V. %	1.69	Pred R-Squared	0.70	
PRESS	67.41	Adeq Precision	12.65	

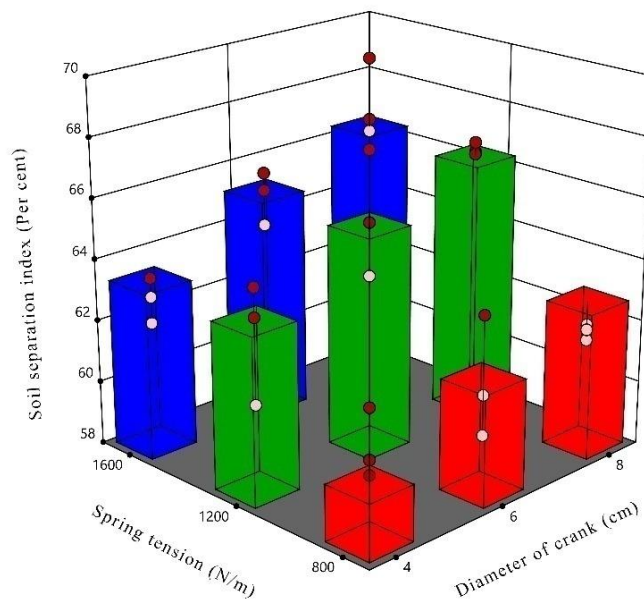
\*\* Significance at 1 % level \* Significance at 5 % level

**Fig.4.45 The conveying efficiency for turmeric**

**Table. 4.28 Analysis of variance on soil separation index in turmeric**

Source of variances	Sum of Squares	DF	Mean Square	F Value
Model	121.20	4	30.30	15.03**
Diameter of crank (A)	40.92	2	20.46	10.15**
Spring tension (B)	80.28	2	40.14	19.91**
Residual	44.35	22	2.02	
Lack of Fit	11.55	4	2.89	1.58
Pure Error	32.80	18	1.82	
Cor Total	165.55	26		
Std. Dev.	1.42	R-Squared	0.73	
Mean	63.86	Adj R-Squared	0.68	
C.V. %	2.22	Pred R-Squared	0.59	
PRESS	66.80	Adeq Precision	10.89	

\*\* Significance at 1 % level \* Significance at 5 % level

**Fig.4.46 The soil separation index for turmeric**

#### 4.15 OPTIMIZATION FOR DIGGING UNIT FOR TURMERIC

Numerical optimization technique was adopted to get optimum levels of independent variables for the designed and tested models using “Design Expert 12.0.4” version software. Optimization constraints of experiments are presented in Table 4.27 and best optimal solutions were presented in the Table 4.28.

##### 4.15.1 Desirability index for digging unit

The highest desirability index of 0.879 was observed at a forward speed of 2.0 km h<sup>-1</sup> with 20 deg. rake angle for V-type blade (Fig 4.45). Hence, this treatment combination of 2.0 km h<sup>-1</sup>, 20 deg. and V-type blade was selected as the optimum for further evaluation of soil separator unit.

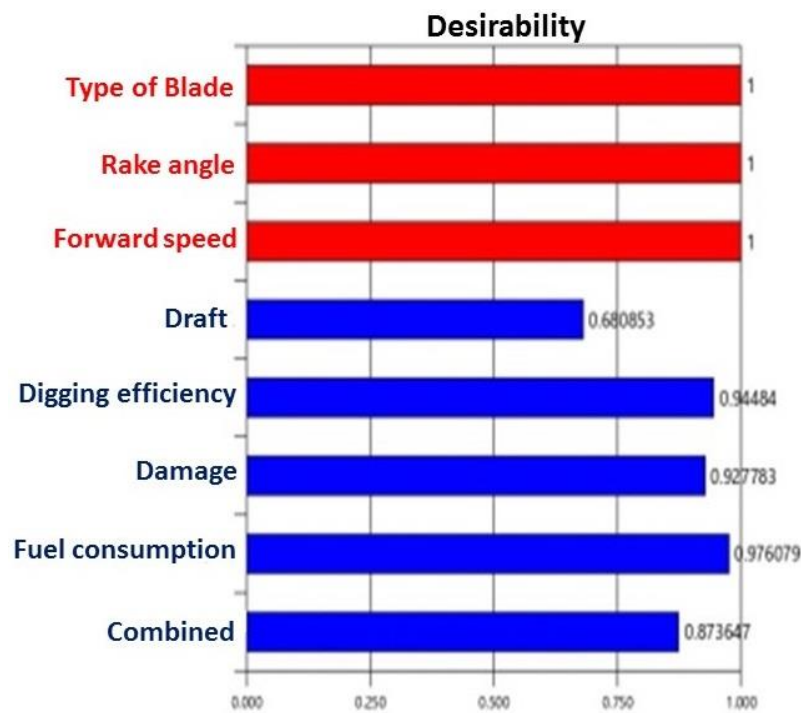


Fig.4.47 Desirability index for optimized digging unit for turmeric



**Table 4.29 Numerical optimization constraints on digging unit**

Name	Goal	Lower Limit	Upper Limit	Lower Weight	Upper Weight	Importance
Type of blade	is in range	Straight edge	Crescent type	1	1	3
Rake angle	is in range	15	25	1	1	3
Forward speed	is in range	1.5	2.5	1	1	3
Draft	minimize	1390.06	2192.08	1	1	3
Digging efficiency	maximize	81.91	99.5	1	1	3
Per cent damage	minimize	0.74	7.3	1	1	3
Fuel consumption	minimize	3.78	5.25	1	1	3

**Table 4.30. Best optimal solutions of digging unit for turmeric**

Sl. No.	Variables	Optimal Values
1	Tool geometry	V – Type
2	Rake angle	20deg.
3	Forward speed	2.0 km h <sup>-1</sup>

#### 4.16 OPTIMIZATION FOR SOIL SEPARATOR UNIT

The soil separator unit of the root crop harvester was evaluated based on the optimized parameters obtained for digging unit. Further the soil separator unit was tested with different treatment combinations *viz.*, diameter of crank (4, 6 and 8 cm) and spring tension (800, 1200 and 1600 N m<sup>-1</sup>). The operational parameters of the soil separator unit were optimized based on the performance parameters of the soil separator unit such as soil separation index and conveying efficiency.

Numerical optimization technique was adopted to get optimum levels of independent variables for the designed and tested models using Design Expert 12.0.4 version software. Optimization constraints of experiments are presented in Table 4.31 and best optimal solutions were presented in the Table 4.32.

#### 4.16.1 Desirability index for soil separator unit

The highest desirability index of 0.789 was observed at a spring tension 1600 N m<sup>-1</sup> with 8 cm diameter of crank (Fig. 4.48). Hence, this treatment combination of 8 cm diameter of crank and 1600 N m<sup>-1</sup> spring tension was chosen as the optimum for further field performance evaluation of root crop harvester.

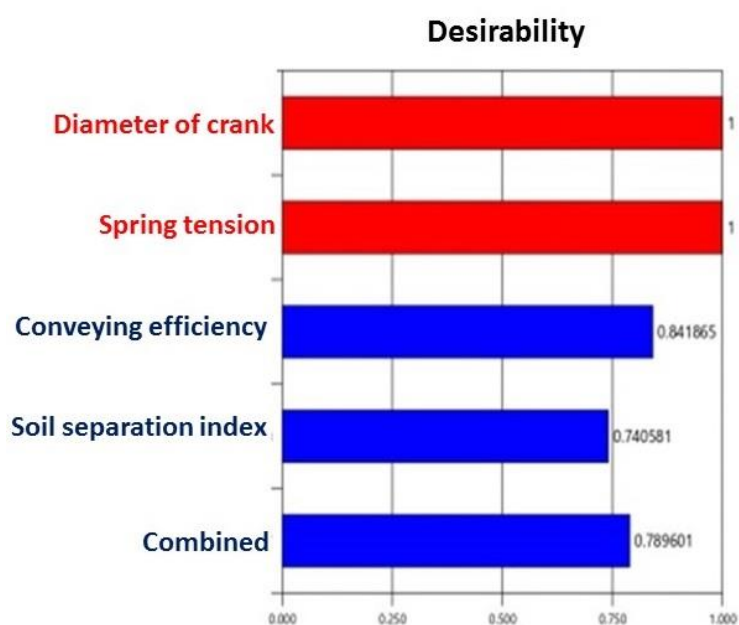


Fig.4.48 Desirability index of soil separator unit for turmeric

Table 4.31 Optimization constraints for soil separator unit

Name	Goal	Lower Limit	Upper Limit	Lower Weight	Upper Weight	Importance
Diameter of crank	is in range	4	8	1	1	3
Spring tension	is in range	800	1600	1	1	3
Conveying efficiency	maximize	76.99	89.71	1	1	3
Soil separation index	maximize	59.78	68.82	1	1	3

Table 4.32. Best optimal solutions of soil separator unit for turmeric

Sl. No.	Variables	Optimal Values
1	Tool geometry	V – type
2	Diameter of crank	8 cm
3	Spring tension	1600 N m <sup>-1</sup>

#### 4.17 PERFORMANCE EVALUATION OF ROOT CROP HARVESTER

Performance evaluation of the developed tractor drawn root crop harvester was carried out in different farmer's fields at Malappuram, Palakkad and Thrissur districts of Kerala. The performance of the root crop harvester was evaluated as per the optimized parameters *viz.*, V-type blade, 20 deg. rake angle and 2.0 km h<sup>-1</sup> forward speed and the diameter of the crank as 80 mm and spring tension 1600 N m<sup>-1</sup>. The prototype root crop harvester was evaluated for 2.0 ha for three crops such as coleus, ginger and turmeric. The performance (Table 4.33) parameters such as depth of operation, width of operation, speed of operation, draft and power requirement and fuel consumption were recorded w.r.to. effective field capacity, field efficiency and digging efficiency.

The root crop harvester was tested separately for three root crops at a forward speed of 2.0 km h<sup>-1</sup>. The draft and power requirement were also found out as 1456.83, 1630.27 and 1646.03 N and 7.93, 8.87 and 8.96 kW respectively. Fuel consumption was observed as 4.18, 5.19 and 5.57 l h<sup>-1</sup> for harvesting of coleus, ginger and turmeric respectively and Theoretical field capacity, effective field capacity and field efficiency of root crop harvester for coleus was 0.18 ha h<sup>-1</sup>, 0.155 ha h<sup>-1</sup> and 86.11 per cent respectively and the for ginger and turmeric it was 0.18 ha h<sup>-1</sup>, 0.16 ha h<sup>-1</sup> and 88.89 per cent respectively.

The digging efficiency of root crop harvester were obtained as 99.89, 99.57 and 99.50 per cent and the damage of tuber/rhizome of root crop harvester were observed as 0.59, 1.21 and 1.24 per cent, for coleus, ginger and turmeric respectively.

The separation index for coleus, ginger and turmeric were recorded as 82.31, 73.22 and 68.82 per cent respectively, while the conveying efficiency were recorded as 90.70, 87.58 and 89.71 per cent respectively. The similar findings were reported in performance of the tractor operated turmeric harvester in accordance with Annamalai and Udayakumar (2007).

**Table 4.33. Performance evaluation of root crop harvester**

Sl. No.	Particulars	Observations		
		Coleus	Ginger	Turmeric
1.	Actual operating time, min	85	75	300
2.	Time loss in turning, min	22.5	18.45	60.25
3.	Forward speed, ms <sup>-1</sup>	0.55	0.55	0.55
4.	Area covered, m <sup>2</sup>	2200	2000	4000
5.	Effective width of cut, mm	900	900	900
6.	Depth of cut, mm	100	200	200
7.	Effective field capacity, ha h <sup>-1</sup>	0.15	0.16	0.16
8.	Theoretical field capacity, ha h <sup>-1</sup>	0.18	0.18	0.18
9.	Field efficiency, %	86.11	88.89	88.89
10.	Draft, N	1456.83	1630.27	1646.03
11.	Digging efficiency, %	99.89	99.57	99.50
12.	Damage of rhizome/tuber, %	0.59	1.24	1.21
13.	Power requirement, kW	7.93	8.87	8.96
14.	Fuel consumption, l h <sup>-1</sup>	4.18	5.19	5.57
15.	Soil separation index, %	82.71	73.22	68.82
16.	Conveying efficiency, %	90.70	87.55	89.71

#### 4.18 COST ECONOMICS OF DEVELOPED ROOT CROP HARVESTER

The estimated cost of the prototype tractor drawn root crop harvester was Rs. 60,000 (Appendix-XIII). The cost of operation was found out as Rs. 767.57 per hour and hence Rs 4797.31 per ha. The breakeven point and payback period of the harvester was 40.00 hours per annum and 1.50 years, respectively. The savings in cost was 85.53 per cent and the saving in labour was 96 per cent over conventional method. The similar economic outcome was reported in performance of the tractor operated onion digger by Khura *et al.*,(2011).

---

## **SUMMARY AND CONCLUSION**

## CHAPTER V

### SUMMARY AND CONCLUSION

Harvesting of tuber/rhizome is an important operation in root crop cultivation which requires immediate attention for developing appropriate mechanical harvesting technology. Conventional method of harvesting tubers/rhizomes is labour intensive; require skilled labour to dig out from soil. The non-availability of such skilled labour and the high wages demanded by them to harvest the crop as well as the higher field losses and damages due to manual harvesting, necessitate the development of a suitable mechanical harvester for commonly cultivated tuber/rhizome crops especially coleus, ginger and turmeric. As tractors are becoming a common power sources in farms, a mechanical harvester attachment to tractor would be the most appropriate technology. The harvester should satisfy the basic requirements of achieving maximum harvesting efficiency with minimum damage to the crop and at lesser cost. Hence an investigation was undertaken to optimize the machine parameters for mechanical harvesting and to develop a suitable tractor mounted root crop harvester to dig out the tubers/rhizomes.

The soil parameters at the time of harvest such as its type, moisture content, bulk density, cone index, shear strength and biometric parameters of crop such as plant density, spread, weight and bulk density which influence the design of root crop harvester were analyzed through experimental trials. The digging unit of the harvester was tested with different treatment combinations of blade geometries *viz.*, straight edge, V-type and crescent blades at different rake angles of 15, 20 and 25 deg. and at different forward speeds of 1.5, 2.0 and 2.5 km h<sup>-1</sup>. The effects due to these parameters were optimized based on performances parameters *viz.*, draft, digging efficiency, damage of tuber/rhizome and fuel consumption.

Numerical optimization technique was adopted to get optimum levels of independent variables for the digging unit w.r.t the designed models using “Design Expert 12.0.4” version software. The best optimal solutions for the digging unit were observed at a forward speed of 2.0 km h<sup>-1</sup> with 20 deg. rake angle for V-type blade.

The soil separator unit of the harvester was tested with different treatment combinations of diameter of cranks of 40, 60 and 80 mm and spring tensions of 800, 1200 and 1600 N m<sup>-1</sup>. The operational parameters of the soil separator unit were optimized based on the performance parameters *viz.*, conveying efficiency and soil separation index.

Numerical optimization technique was also adopted to get optimum levels of independent variables for the soil separator unit w.r.t the designed models using “Design Expert 12.0.4” version software. The best optimal solutions were observed for diameter of crank 80 mm with 1600 N m<sup>-1</sup> spring tension of springs. All the field experimental data were analyzed by using factorial design in ‘Design Expert’ version 12.04 software. Desirability index was found out and accordingly the best optimal solutions were separately found out for digging and soil separator units of the harvester. Thus, the prototype of the root crop harvester was developed for harvesting of coleus, ginger and turmeric at the research workshop of Department of Farm Machinery and Power Engineering, KCAET, Tavanur and the field trials were conducted in the KCAET Instructional Farm, RARS Pattambi, State Seed Complex, Munderi and farmers’ fields at Thrissur and Palakkad districts.

The performance of the tractor operated root crop harvester was evaluated in terms of draft, digging efficiency, per cent damage of tuber/rhizome, fuel consumption, soil separation index and conveying efficiency. The comparison between manual harvesting and the tractor drawn root crop harvester were conducted for analyzing efficiency and cost economics of the two methods.

The following conclusions were drawn:

- The soils of the experimental location was found out laterite soil and sandy clay loam, also observed that the coleus is cultivated generally in loamy soils where as ginger and turmeric are cultivated in clay and sandy loam soils.
- The moisture content of the soil ranged from 14.50 to 17.34 per cent with an average mean of 15.71 per cent and a coefficient of variation of 8.09 per cent.
- The bulk density of the soil ranged from 1590 to 1830 kg m<sup>-3</sup> with an average mean of 1716 kg m<sup>-3</sup>. The coefficient of variation was found as 5.11 per cent.

- The cone index varied from 0.83 to 1.51 kg cm<sup>-2</sup>. The highest value of the cone index was about 1.51 kg cm<sup>-2</sup> at the soil moisture of 14.50 per cent.
- The shear strength of soil varied from 0.0128 to 0.0142 kg cm<sup>-2</sup> with an average mean of 0.0136 kg cm<sup>-2</sup>. The highest value (0.0142 kg) of shear strength of soil at the soil moisture content of 14.50 per cent and at 10 cm depth of soil.
- The number of leaves per plant ranged from 15-25, 10 to 29 and 6-12 with average of 20.90, 19.60 and 9.20 for coleus, ginger and turmeric respectively.
- The plant length of coleus, ginger and turmeric crops ranged from 50-70, 16.0 to 35.0 and 20.0-50.0 cm with a mean of 56.52, 24.70 and 39.50 cm respectively.
- The average depths of the tuber/rhizome with respect to ground level were 8.96, 16.45 and 18.15 cm with the minimum of 8, 11 and 15 cm and the maximum of 10, 20 and 21 cm for coleus, ginger and turmeric respectively.
- The range of plant densities of coleus, ginger and turmeric were found out as 15-18, 9-12 and 9-12 numbers and average means of plant densities of 16.30, 10.70 and 10.60 numbers respectively.
- Row to row spacing of coleus, ginger and turmeric varied from 25 to 30 and 25-30 cm with average values of 30.10, 28.90 and 28.30 cm respectively.
- The weight of coleus, ginger and turmeric yield per plant ranged from 0.20 to 0.35, 0.35 to 1.30 and 0.45 to 0.75 kg and their mean values were 0.289, 0.764 and 0.615 kg respectively.
- The average size of coleus was found out as 4.8, 3.37 and 2.38 cm as the length, width and thickness respectively. The geometric mean diameter was found out as 3.29 cm whereas, sphericity was 0.69.
- Tuber index was found out as 67.59. The average bulk volume and bulk density were found out as 179.30 cm<sup>3</sup> and 720.0 kg m<sup>-3</sup> respectively.
- The average size of ginger was found out as 16.52, 9.75 and 4.08 cm as length, width and thickness respectively. The geometric mean diameter was found out as 8.8 cm whereas, sphericity of rhizome was 0.53. The rhizome index was



found out as 42.18. The average bulk volume and bulk density were found out as 211.20 cm<sup>3</sup> and 491.82 kg m<sup>-3</sup> respectively.

- The average size of turmeric was found out as 13.83, 10.12 and 3.56 cm along length, width and thickness respectively. The geometric mean diameter was found to be 7.83 cm whereas, sphericity of rhizome was 0.578. The rhizome index was found out as 39.95. The average bulk volume and bulk density were found out as 194.20 cm<sup>3</sup> and 481.63 kg m<sup>-3</sup> respectively.
- The average surface area of coleus, ginger and turmeric were measured as 35.56, 235.2 and 195.20 cm<sup>2</sup> respectively.
- The mean coefficient of friction of coleus for stainless steel, plywood and galvanized iron were found out as 0.70, 0.81 and 0.72 respectively while for ginger, these were found out as 0.50, 0.56 and 0.54 respectively and for turmeric, these were found out as 0.57, 0.575 and 0.66 respectively.
- The angle of repose for coleus, ginger and turmeric were measured as 37.60, 34.33 and 31.69 deg.
- The maximum draft of 2009.52 N was recorded in straight edge blade at the forward speed of 2.5 km h<sup>-1</sup> and rake angle of 25 deg. for coleus.
- For V-type blade, minimum draft of 1418.66 N was recorded at the rake angle of 20 deg. and for the forward speed of 2.0 km h<sup>-1</sup>, which was 29.40 per cent lower than the straight edge blade for coleus.
- Maximum digging efficiency of 99.89 per cent was noticed in V-type blade at the forward speed of 2.0 km h<sup>-1</sup> and at 20 deg. rake angle, where as minimum digging efficiency of 84.15 per cent observed in straight edge blade at the forward speed of 1.5 km h<sup>-1</sup> and rake angle of 15 deg. for coleus.
- The least damage of 0.59 per cent was observed for the tubers with V-type blade at rake angle of 20 deg. and forward speed of 2.0 km h<sup>-1</sup>. The highest damage of 5.5 per cent was observed for the tubers with crescent blade at 25 deg. rake angle and at forward speed of 2.5 km h<sup>-1</sup> for coleus.
- Among the different type of blades the less fuel consumption of 3.80 l h<sup>-1</sup> was noticed for V-type blade at the rake angle of 15 deg. and at the forward speed of 2.0 km h<sup>-1</sup>, whereas maximum of 4.98 l h<sup>-1</sup> was noticed in straight edge

blade at the rake angle of 25 deg. and at the forward speed of 2.5 km h<sup>-1</sup> for coleus.

- The maximum soil separation index of 82.71 per cent was noticed for harvesting of coleus for 80 mm diameter of crank at 1600 N m<sup>-1</sup> spring tension.
- The maximum conveying efficiency of 90.70 per cent was noticed for 80 mm diameter of crank at 1600 N m<sup>-1</sup> spring tension. The least conveying efficiency of 79.10 per cent was noticed for 40 mm diameter of crank at 800 N m<sup>-1</sup> spring tension.
- The highest desirability index of 0.872 was observed at a forward speed of 2.0 km h<sup>-1</sup> with 20 deg. rake angle for V-type blade.
- The highest desirability index of 0.888 was observed for 80 mm diameter of crank at 1600 N m<sup>-1</sup> spring tension for coleus.
- The effective field capacity and field efficiency of prototype root crop harvester for harvesting coleus were noticed as 0.16 ha h<sup>-1</sup> and 86.11 per cent respectively.
- The maximum draft of 2176.33 N was recorded in straight edge blade at the forward speed of 2.5 km h<sup>-1</sup> and rake angle of 25 deg. for ginger.
- For V-type blade, minimum draft of 1374.31 N was recorded at the rake angle of 20 deg. and for the forward speed of 2.0 km h<sup>-1</sup>, which was 37.0 per cent lower than the straight edge blade for ginger.
- Maximum digging efficiency of 99.57 per cent was noticed in V-type blade at the forward speed of 2.0 km h<sup>-1</sup> and at 20 deg. rake angle, whereas minimum digging efficiency of 80.40 per cent observed in straight edge blade at the forward speed of 1.5 km h<sup>-1</sup> and rake angle of 15 deg. for ginger.
- The least damage to coleus of 0.86 per cent was observed in V-type blade at rake angle of 20 deg. and forward speed of 2.0 km h<sup>-1</sup>. A highest damage of rhizome of 6.05 per cent was obtained in crescent blade at 15 deg. rake angle and at forward speed of 2.5 km h<sup>-1</sup> for ginger.
- Among the different type of blades the least fuel consumption of 3.74 l h<sup>-1</sup> was noticed for V-type blade at the rake angle of 15 deg. and at the forward speed of 2.0 km h<sup>-1</sup>, whereas maximum of 5.19 l h<sup>-1</sup> was noticed in straight edge

blade at the rake angle of 25 deg. and at the forward speed of 2.5 km h<sup>-1</sup> for ginger.

- The maximum soil separation index of 73.21 per cent was noticed for harvesting of ginger for 80 mm diameter of crank at 1600 N m<sup>-1</sup> spring tension.
- The maximum conveying efficiency of 87.55 per cent was noticed for 80 mm diameter of crank at 1600 N m<sup>-1</sup> spring tension for ginger. The least conveying efficiency of 75.95 per cent was noticed for 40 mm diameter of crank at 800 N m<sup>-1</sup> spring tension.
- The best desirability index of 0.823 was observed at a forward speed of 2.0 km h<sup>-1</sup> with 20 deg. rake angle for V-type blade and the highest desirability index of 0.882 was observed for 80 mm diameter of crank at 1600 N m<sup>-1</sup> spring tension for ginger.
- The effective field capacity and field efficiency of prototype root crop harvester for ginger were noticed as 0.16 ha h<sup>-1</sup> and 88.89 per cent respectively.
- The maximum draft of 2192.08 N was recorded in straightedge blade at the forward speed of 2.5 km h<sup>-1</sup> and rake angle of 25 deg. for turmeric.
- For V-type blade, minimum draft of 1390.06 N was recorded at the rake angle of 20 deg. and for the forward speed of 1.5 km h<sup>-1</sup>, which was 36.60 per cent lower than the straightedge blade for turmeric.
- Maximum digging efficiency of 99.50 per cent was noticed in V-type blade at the forward speed of 2.0 km h<sup>-1</sup> and at 25 deg. rake angle, where as minimum digging efficiency of 81.91 per cent observed in straight edge blade at the forward speed of 1.5 km h<sup>-1</sup> and rake angle of 15 deg. for turmeric.
- The least damage to turmeric of 0.74 per cent was observed in V-type blade at rake angle of 20 deg. and forward speed of 2.0 km h<sup>-1</sup>. A highest damage of rhizome of 7.3 per cent was obtained in crescent blade at 15 deg. rake angle and at forward speed of 2.5 km h<sup>-1</sup> for turmeric.
- Among the different type of blades the least fuel consumption of 4.0 l h<sup>-1</sup> was noticed for V-type blade at the rake angle of 15 deg. and at the forward speed of 2.0 km h<sup>-1</sup>, whereas maximum of 5.57 l h<sup>-1</sup> was noticed in straight blade at the rake angle of 25 deg. and at the forward speed of 2.5 km h<sup>-1</sup> for turmeric.

- The maximum soil separation index of 68.82 per cent was noticed for harvesting of turmeric for 80 mm diameter of crank at 1600 N m<sup>-1</sup> spring tension.
- The maximum conveying efficiency of 89.71 per cent was noticed for 80 mm diameter of crank at 1600 N m<sup>-1</sup> spring tension for turmeric. The least conveying efficiency of 76.99 per cent was noticed for 40 mm diameter of crank at 800 N m<sup>-1</sup> spring tension.
- The highest desirability index of 0.851 was observed at a forward speed of 2.0 km h<sup>-1</sup> with 20 deg. rake angle for V-type blade and the highest desirability index of 0.791 was observed for 80 mm diameter of crank at 1600 N m<sup>-1</sup> spring tension for turmeric.
- The effective field capacity and field efficiency of prototype root crop harvester for turmeric were noticed as 0.16 ha h<sup>-1</sup> and 88.89 per cent respectively.
- The estimated cost of the prototype tractor drawn root crop harvester was Rs. 60,000. The cost of operation was found out as Rs. 767.57 per hour
- The breakeven point and payback period of root crop harvester was 40.00 hours per annum and 1.50 years respectively.
- The saving in cost of root crop harvester for three root crops was 89 per cent.

### **Suggestion for future work**

The following are the suggestions for future work on a similar or related research problem.

- Design and development of conveying cum soil separator mechanism for the uprooted tubers/rhizomes
- Suitably design/modify the tractor wheels to work in wet land conditions.
- Conduct field trials for uprooting groundnuts and incorporate suitable design modifications, if required to the digging and soil separator unit of the harvester.

---

## REFERENCES

## REFERENCES

- Abdalla Kheiry, N.O., Amgad Elssir, Abbas, E., Rahma, Mysara Ahmed Mohamed, Elnogomi, A., Omer, Hu Jian Dong and Yuan Liwei. 2018. Effect of operation variables of potato digger with double chain conveyors on crop handling and machine performance. *Inter. J. Env. & Agr. Res.* 4(6):87-101.
- Agbetoye, L.A.S., Kilgour, J., and Dyson, J. 1998. Performance evaluation of three pre-lift soil loosening devices for cassava root harvesting. *Soil & Tillage Res.* 48(1): 297-302.
- Agodzo, S.K. and Adama, I. 2003. Bulk density, cone index and water content relations for some ghanaiian soils. Kwame Nkrumah University of Science and Technology, Kumasi-Ghana.
- Ajav, E.A. and Ogunlade, C.A. 2014. Physical properties of ginger (*ZingigerOfficinale*). *Global J. Sci. Frontier Res.*, 4(1): 25-33.
- Akhir, H., Ahmad, D., Rukunudin, I.H., Shamsuddin, S., and Yahya, A. 2014. Design and development of a sweet potato digging device. *Pertanika J. Sci. and Technol.*, 22(1): 43-53.
- Akinbamowo, R. 2013. Modelling the performance of a tractor mounted cocoyam harvester, *Nigeria Research and Reviews: J. Agri. and Allied Sci.* 2(2): 37-44.
- Amin, E. A., Ismail, Z. E., El-Shabrawy, T. H., and Faleih, H.S. 2014. Influence of some factors affecting carrot harvesting. *J. Soil Sci. and Agric. Eng., Mansoura Univ.* Vol. 5 (6): 911 - 922.
- Angelis, D.M. 2007. Measurement of soil moisture content by gravimetric method. *American Soc. of Agro.* Pp:1-2.
- Annamalai, S. J. K. and Udayakumar, R. 2007. Optimization of operational parameters of digger cum elevator type turmeric harvester. *IAEC.* 4(1): 21-27.

- Annamalai, S. J. K. and Ravindra, N. 2012. Performance of power tiller mounted turmeric harvester at optimized crop and operational parameters. *J. Plantation Crops*. 40(3): 193-198.
- Anonymous. 1974. Proceedings of XVIII annual workshop on AICRP on farm implements and machinery held at Ludhiana, IARI, New Delhi.
- Anonymous. 2002. Tractor mounted turmeric digger developed by Mahatma Phule KirishiVishavaVidhyalaya (M.P.K.V), Rahuri, India.
- Anonymous. 2010, Ministry of agriculture, Govt. of India. [www.moa.gov.in](http://www.moa.gov.in).
- Anonymous, 2019, Area, production and productivity of ginger and turmeric in India, Department of Agriculture, Cooperation and Farmers Horticulture Statistics Division, Agricultural Statistics at a glance.
- Ashok, P. 2003. Studies on growth and development in relation to yield and storage qualities in onion (*Allium Cepa L*).*Unpublished Ph.D. Thesis*. IARI, New Delhi, India-110012.
- Asairo, F. U. and Anthony, O. A. 2011. Determination of some physical properties of African yam beans. *The Pacific J. Sci. Technol.* 12(1): 11-16.
- Awadhwal, N.K., Takenaga, T., and Babu, M.M. 1995. Development of a chisel digger for harvesting groundnut. *Agric. Engg. J.* 4(4): 207-215.
- Azizi, P., Sakenian, N., and Farhadi, R. 2014. Design, development and evaluation of potato digger with rotary blade. *Pertanika J. Sci. and Technol.* 3(1):159-171.
- Babalola, A. A., Adetifa, B.O., Lawal, N.S., Samuel, T. and Koya, O. 2018. Development of manually operated cassava harvester using hydraulic medium. *FULafia J. of Sci. & Tech.* 4(s):23-29.
- Ballaney, P.L. 1990. Theory of machines. Khanna Publisher, New Delhi. 853p.

- Bangar, V. T., Jadhav, S. R., Patil, K. D., Biradar, V. U., and Ostwal, R. S. 2016. Design and development of potato harvester. *J. Food Sci. and Agri.* 80(2): 209-215.
- Bartley, J. and Jacobs, A. 2000. Effects of drying on flavour compounds in Australian-grown. *J. Sci. Food and Agric.* 80: 209-215.
- Balasubramanian, S., Mohite, A. M., Singh, K. K., Zachariah, T. J., and Anand, T. 2012. Physical properties of turmeric. *J. of Spi. and Aro. Cr.* 21(2): 178-181.
- Bernacki, H., Haman, J., and Kanafojski, Cz. 1972. Agricultural Machines, theory and construction. *Scientific publication* 1(3): 359-360.
- Bhawna, S. Shirsat, S. Patel, P., Borkar, A., and Bakane, P. H. 2018. Physical properties of fresh ginger (*Zingiber Officinale*) rhizomes. *Mult. In Sci.* 8(25): 304-307.
- Bobobee, E.Y.H., Okyere, J. B., and Asare, E. 1994. Mechanical Cassava Harvesting Technique: Final Report. National Agricultural Research Project (NARP)- Council for Industrial and Scientific Research (CSIR).
- Chattopadhyay, S. B., Ghosh, S. K., and Mukhopadhyay, T. P. 1993. Effect of planting distance on growth and yield of turmeric. *Indian Agril.* 37:123-126.
- Danuwat, T. and Saree, W. 2012. Development of cassava digger and conveyor units. *Amer. J. Experi. Agg.* 2(3): 458-469.
- Darina Hroncova, Peter Frankovsky, Ivan Virgala and Ingrid Delyova. 2014. Kinematic analysis of the press mechanism using MSC Adams. *Amer. J. of Mech. Engg.* 2(7): 312-315.
- Dawelbeit, I. M. and Wright, E. M. 1999. Design and testing of a vibratory peanut digger. *Appl. Engg. Agril.* 15(5): 389-392.
- Dhinesh Kumar V. and Ananda Kumar S. 2016. Physical and engineering properties of turmeric rhizome. *J. of Food Res. and Tech.* 4(1):30-34.



- Duraisamy, V.M. 1997. Investigations on the effect of soil, crop, machine and operational parameters in relation to mechanical harvesting of groundnut. *Unpublished Ph.D. thesis*, Tamil Nadu Agricultural University, Coimbatore.
- Evans, Dean E., Clarence, E., Johnson and Robert, L., Schafer. 1982. Tillage tools: How arrangement affects draft. *Agril. Engg.* 18-21.
- Elbanna, E. B., Ismail, I and Abou El-Magd, A.E. 2010. Performance of developed planting and harvesting sugar beet machine. *J. Soil. and Agric. Engg.*1(8): 747-764.
- Ferguson, S. A., Fielke, J. M., and Riley, T. W. 1998. Wear of cultivator shares in abrasive south Australian soils. *J. Agri. Engg. Res.* 69(2):99-105.
- Fielke, J. M. 1996. Interactions of the cutting edge of implements with the soil. *J. Agri. Engg. Res.* 63:61-72.
- Gadir, O. A. and Desa, A. 2001. Comparative study on different peanut digging blades. *AMA.* 32(3): 43-45.
- Ghasem Abedi, Shamsollah Abdollahpour, and Mohammad Reza Bakhtiari. 2019. The physical and mechanical properties of potato (*Solanum tuberosum L.*) tubers as related to the automatic separation from clods and stones. *Res. in Agri. Engg.* 65 (3): 77–84.
- Govindarajan, V.S. 1980. Turmeric - Chemistry, Technology and Quality. *CRC critical reviews on Food and Nutrition.* 12(3): 199-301.
- Gulsoylu, E., Cakir, E., Aykas, E., Yalcin, H., Cakmak, B., and Cay, A. 2012. Determination of the field performances of different types of chisel legs. *Bulgarian J. Agrl. Sci.* 18 (5): 794-800.
- Harrison, H. P. 1982. Soil reactions from laboratory studies with an inclined blade. *Trans. ASAE.* 25(1): 7-12.

- Hettiaratchi, D. R. P., Witney, B. D., and Reece, A. R. 1966. The calculation of passive pressure in two dimensional soil failure. *J. of Agri. Engg. Res.* 11(2): 89-107.
- Hettiaratchi, D. R. P. and Reece, A. R. 1974. The calculation of passive soil resistance. *Geo-technique.* 24(3): 289-310.
- Ibrahim, M. M., Amin, E., and Farag, A. 2008. Developing a multipurpose digger for harvesting root crop. *Misr J. Ag. Engg.* 25(4): 1225-1239.
- IS: 9164, 1979, Guide for estimating cost of farm machinery operation. Indian standards institution. Govt. India, New Delhi. 1-17.
- Jadhav, R. V., Turbatmath, P. A., and Gharte, L. V. 1995. Design, development and performance evaluation of onion digger soil separator. *AMA* 26(3): 35-38.
- Jarugula Pavani. 2017. Design, development and performance evaluation of tractor operated onion digger. Published M.Tech.(Agr.Engg.) Thesis Jawaharlal Nehru Krishi Vishwa Vidyalaya, Jabalpur.
- Jayashree, E. and Visvanathan, R. 2011. Physical and biochemical parameters of fresh and dry ginger (*Zingiber officinale*). *J. Spices Aromat. Crops* 20(1): 14-21.
- Jayan, P.R. and Sanchu, S. 2012. Development and testing of a self-propelled coleus harvester. *Int. J. Agri. Eng.*, 5(1): 21-24.
- Karthick, V., Alagumani, T., and Anbarassan, A. 2015. Growth and export performance of ginger in India- An economic analysis. *J. Food Sci. Technol.* 3(4): 21-29.
- Kathirvel, K. and Mainin, R. 2002. Effect of tool geometry on harvesting efficiency of turmeric harvester. *AMA.* 33(1): 39-42.
- Kamran Ikram, Muhammad Nadeem, Muhammad Usman Ghani, Muhammad Mubashar Omar and Muhammad Sohiab Malik, 2018. Fabrication and

performance evaluation of carrot digger. *J. Glob. Innov. Agric. Soc. Sci.* 6(3):84-87.

Kawale Nagendra, Anantachar, M., Praveen Jholgikar, Veerangouda, M., Prakash, K.V., Ramappa, K.T., and Krishnamurthy, D. 2018. Development and evaluation of tractor drawn ginger harvester cum elevator. *Int.J.Curr. Microbiol. App.Sci.* 7(12): 1942-1949.

Kepner, R. A., Bainer, R., and Barger, E. L., 2005, Principles of farm machinery. Third edition, *CBS Publishers and Distributors*, New Delhi: 113-134.

KAU (Kerala Agricultural University). 2016. *Package of Practices Recommendations: Crops*. Kerala Agricultural University, Thrissur. 237p.

Khambe, V. K. 2012. Studies on design parameters of mechanical Harvesting of garlic. Published M.Sc.(Ag.) thesis in Division of Agricultural Engineering, Indian Agricultural Research Institute, New Delhi.

Khambe, V. K., Dipankar, D., and Sahoo, P. K. 2013. Design and development of a tractor operated garlic harvester. *J. Agril. Engg.* 50 (1): 9-13.

Khambalkar, V.P., Mahulikar, A.M., Kalbande, S. R., and Thakare, S. H. 2017. Study on physical properties for turmeric rhizomes. *Mult. in Sci.* 6(19): 138-141.

Khura, T. K., Mishra, I. M., and Shrivastava, A. P. 2010. Some engineering properties of onion crop relevant to design of onion digger. *J. Agril.Engg.* 47 (1): 1-8.

Khura, T. K., Mishra, I. M., and Shrivastava, A. P. 2011. Design and development of tractor-drawn onion (*Allium cepa* L.) harvester. *Indian. J. Agril. Sci.* 81 (6): 528-532.

Khurana, R., Manes, J. S., Dixit A., Singh, A., Mahal, J. S., and Singh, B. P. 2012. Prototype feasibility testing of tractor operated root crop harvester. *Annual Report, Punjab agricultural university, Ludhiana.*

Mohamed Favazil, P., Jayan, P.R., Chinnu, S.R., and Rachana, C. 2019. Testing of mini-tractor operated coleus digger. *Int. Res.J.Engg.Tech.* 6(1): 964-977.

- Mareppa, N.B., Veeragouda, M., Palled, V., Prakash, K. V., Shriwal, S., Anantachar, M., and Chilur, R. 2014. Optimazation of operational parameters of self-propelled groundnut digger. *Int. J. of Engg. Sci. and Inn. Tech.* 3(5):393-400.
- Mendi, S. D., Nain, C. W., Mfopit, M. Y., Tanya, A., and Mbofung, M. F. 2009. Nutritional merits of a ginger-spiced cheese fed to male wistar rats. *Pak. J. of Nutri.* 8(3): 1415-1421.
- Mehta, T. D and Yadav, R. 2015. Development and performance evaluation of tractor operated onion harvester. *AMA.* 46(4): 7-13.
- Misener, G. C. and McMillan, L.P. 1982. A single-hill potato digger. *American Potato Journal.* 59 (11): 551-553.
- Mizrack, A., Margolin, A., Feller, R., and Alper, Y. 1983. Peanut salvage machine for sandy loam and clay loam soils. *Trans. ASAE.* 26(2): 389-391.
- Moayad, B., Zaied, A. M. El, N., Mohammed, H. D., and Afraa, S. M. 2014. Development of powered groundnut harvester for small and medium holdings in North Kordofan State in Western Sudan. *World J. Agril Res.* 2(3): 119-123.
- Mohsenin, N. M. 1986. Physical properties of plant and animal materials. 2nd edn. (Revised). *J.Gordon and Breach Sci.* 14(2):25-30.
- Munde, P. A., Nadre, R. G., and Sawant, B. P. 2009. Development and performance evaluation of bullock drawn turmeric digger. *Intl. J. Agril. Engg.* 2(1): 14-17.
- Narayana Rao, P.V. 1974. Development and preliminary trials of animal drawn groundnut harvester-picker. *The Agri. Eng.* 17: 15-17.
- Naresh, Vijaya Rani, Mukesh Jain and Anil Kumar. 2018. Design and development of tractor operated carrot digger. *AMA.* 49(3): 7-85.

- Narender, Vijay Rani, Mukesh, S., Anil Kumar, and Parmod Sharma. 2019. Optimization of performance parameters of root crop digger for potato crop. *Cu. Agri. Res. J.*7(2):276-282.
- Nelkon, M. 2005. Principles of physics for senior secondary schools. 6<sup>th</sup> Ed., Heinemann London, London.
- Odigboh, E.U. and Ahmed, S.F. 1982. A cassava harvester - Design analysis and prototype development. *AMA.* 13(3):40-48.
- Olaoye, J. O. 2000. Some Physical properties of castor nut relevant to the design of processing equipment. *J. Agric. Engg. Res.* 77(1): 113-118.
- Pratap, S. and Pandey, K. P. 1981. Soil separation and power requirement of a potato elevator digger. *AMA.* 3(4): 27-29.
- Pramod Reddy, A., Moses, S. C., and Rana Noor Aalam. 2018. Performance Evaluation of Adjustable Elevator for Tractor Drawn Potato Digger. *Int. J. Curr. Microbiol. App.Sci.* 7(11): 1502-1513.
- Ramachandran, S. and Manohar Jesudas, D. 2017. Measurement of soil cone index in wet rice field soil using digital hand-held cone penetrometer. *Int. J. Agri.Sci.* 9(45): 4757-4762.
- Rangasamy, K., Durairaj, C.D., and Manjan, R. 2003. Cost-effective tractor drawn turmeric harvester. Unpublished Ph.D thesis, College of Agricultural Engineering, TNAU, Coimbatore.
- Rattan, R. S., Korla, B. N., and Dohroo, N. P. 1988. Performance of ginger varieties under Solan conditions of Himachal Pradesh. *Proceedings of National Seminar on Chillies, Ginger and Turmeric.* pp 71-73.
- Sadeeq, A. M. and Al-Rajaboo, S. A. 2008. Effect of separating systems design of potato diggers on quantitative and qualitative loss of crop. *Dirasat Agri. Sci.* 35(1): 33-43.

- Sakib, G.S. and Wright, M.E. 1986. Vibratory diggers for harvesting sweet potatoes in cloddy soils. *J. Agri. Engg. Res.* 34(1):53-61.
- Saleh, A. AL-Suhaibani., and Abdulrahman, AL-Janobi. 1997. Draft requirement of tillage implements operating on sandy-loam soil. *J. Agril. Engg. Res.* 66(2): 177-182.
- Sandeep, M. and Sudhama, A. 1998. Performance evaluation of potato digger as an onion digger. *Pap. Presented at National Conventional Agri. Engineers Institute of Engineers, Coimbatore.*
- Sivaraman, K. 1992. Study on the productivity of turmeric, maize and onion intercropping systems under varied population and nitrogen levels. Unpublished Ph.d Thesis, Tamilnadu Agricultural University, Coimbatore.
- Sharma, A. P. and Verma, S. R. 1986. Design, development and field evaluation of an oscillatory potato digger. *AMA.* 17(3): 60-62.
- Shailaja Deshvena, Ramteke, R.T., and Solanki, S.N. 2019. Development and performance evaluation of tractor drawn turmeric digger cum separator. *Int. J. Curr. Microbiol. App. Sci.* 8(2): 1053-1061.
- Shirwal, S. 2010. Studies on design parameters for mechanical harvesting of carrots. Unpublished M.Sc Thesis in Division of Agricultural Engineering, Indian Agricultural Research Institute, New Delhi.
- Shirwal, S., Mani, I., and Shirohi, N. P. S. 2014. Effect of design parameters on mechanical harvesting of carrots. *Scientific J. Agril. Engg.* 34(2): 69-80.
- Simonyan, K. J., Ehiem, J. C., Eke, A. B., Adama, J. C., and Okpara, D. A. 2013. Some physical properties of ginger varieties. *J. Appl. Agri. Res.* 5(1): 73-79.
- Singh, M. C. 2014. Development and performance evaluation of a digger for harvesting onion (*Allium cepa* L.). *Int. J. Agri. Engg.* 72(2) 391-394.
- Smith, G.D. 1968. Soil classification in the United States. World soil resource rep. FAO 32:6-24.

- Srivastava, N.S.L. and Yadav, R.N.S. 1978. Mechanizing sugar beet cultivation in India. *The Agri. Eng.* 21:35-38.
- Sukhwinder Singh. 2007. Design, development and field testing of a multipurpose potato digger. *Potato Journal.* 33(3):4.
- Sungha Hong, Kyouseung Lee, Yongjin Cho, and Wonyeop Park. 2014. Development of welsh onion harvester for tractor. *J. of Biosystem. Eng.* 39(4):290-298.
- Sunil, G and Manjit, S. 1999. Design and development of an oscillating type potato digger. Proceedings of the Global Conference on Potato, New Delhi, India, 2(1): 6-11.
- Surendra Babu, M., Prasanna, K. B., Swami, D. V., Uma, K. K., and Emmanuel, N. 2017. Performance of ginger (*Zingiber officinale*Rosc) varieties under shade net condition of costal Andhra Pradesh. *Int. J. Curr. Microbiol. App. Sci.*, 6(7): 494-498.
- Tiwari, P. S., Thakur, T. C., and Bhagwan Singh. 1994. Investigation into the field performance of tractor drawn potato diggers. *J. Agric. Engg.* 31(14): 44-57.
- Tiwari, V. K. and Jethva, K. R. 2001. Development of groundnut digger blade suitable for a small tractor. *Agri. Engg. Today.* 26(3-4): 1-6.
- Trivedi, S. K. and Singh, R. K. 1975. Design and development of two row tractor drawn potato digger. *Unpublished B.Tech. Thesis in Agricultural Engineering Department. G. B. Pant University of Agricultural and Technology, Pantnagar, Nainital.*
- Vasta, D.K., Thnakur, T.C. and Singh, B. 1993. Effect of speed and shape of shares on performance of oscillatory sieve potato digger. *AMA.* 24(4): 51-56.
- Venkatareddy, H.K. 2018. Design analysis of KAU pokkali paddy harvester towards the development of its scale down prototype. Unpublished M.Tech. thesis. Kerala Agricultural University, Thrissur.

- Wajire, Pooja, N., Jadhav, M. V., Pareek, C. M., Thakare, S. H., and Khambalkar, V. P. 2018. Development and performance evaluation of tractor operated tuber rhizomes digger. *Green Farming* 9(2): 383-386.
- Wasiya Farzana, Pricy Niruba, P., and Adu Emmanuel Adeyemi. 2017. Physical properties of raw PTS 10 turmeric variety. *J. of Pharm. and Phyto.* 1(1): 782-786.
- Wulfsohn, D., Adams, B. A., and Fredlund, D. G. 1996. Application of unsaturated soil mechanics for agricultural conditions. *Canadian Agrl. Engg.* 38(3): 173-181.
- Yadav, A. R., Nawale, R. N., Korake, G. N., and Khandekar, R. G. 2013. Effect of dates of planting and spacing on growth and yield characteristics of ginger (*Zingiber officinale* Ros.) var. IISR Mahima. *J. Spices Aromatic Crops* 22(2): 209-214.
- Yerima, Y., Turu, E. M., Ngubi, F. W., Azuokwu, A. A., and Obeta, O. P. 2016. Design related parameters of Nigerian ginger rhizomes. *Int. J. Sci. Engg. Res.* 7(5): 21-29.
- Yumnam, J. and Pratap, S. 1991. Energetic of forage chopping. *AMA.* 22(1): 59-63.
- Younus, A. and Jayan, P.R. 2016. Modification and testing of a coleus harvester. *Int. J. of Adv. in Eng. Tech. Manag. & Apl. Sc.* 3: 16-19.
- Zate, G.K., Tekale, D.D., and Solanke, K. R. 2018. To investigate performance of bullock drawn turmeric and ginger harvesting equipment. *Multi. log.sci.* 8(27):258-263.



---

***APPENDICES***

## Appendix - I

## Biometric observations of tuber/rhizome in the field at the time of harvesting

Sl. No.	Parameter	Range			Mean		
		Coleus	Ginger	Turmeric	Coleus	Ginger	Turmeric
1	Number of leaves	15-25	10 - 29	6-12	20.90	19.60	9.20
2	Height of plant, cm	50 - 70	16-35	20 -50	56.52	24.70	39.50
3	Depth of rhizome/tuber,cm	8-10	11 -20	15 - 21	8.96	16.45	18.15
4	Plant density, no/m <sup>2</sup>	15 -18	9-12	9 - 12	16.30	10.70	10.60
5	Plant to plant spacing, cm	15-16	20-25	20 - 25	15.20	24.20	23.90
6	Row to row spacing, cm	30	25-30	25-30	30.10	28.90	28.3
7	Rhizome/tuber spread, cm	7-12	11 - 21	17-20	9.55	17.45	18.60
8	Rhizome/tuber weight, kg	0.20 - .035	0.35- 1.3	0.45-0.75	0.28	0.76	0.61
9	No. of rhizome fingers/tuber haulms per hill,	8-15	5 - 14	3 -12	11.10	10.00	8.20
10	Weight of rhizome/tuber with plant, kg	0.35 - 0.75	0.5 - 1.20	1.3-1.50	0.61	1.35	1.39

## Appendix - II

## Physical properties of coleus

Sl. No	Size (cm)			Geometric mean, dia, (cm)	Sphericity	Tuber Index	Surface area (cm <sup>2</sup> )	Bulk volume (cm <sup>3</sup> )	Bulk density (kg m <sup>-3</sup> )
	Length	Width	Thickness						
1	4.81	2.83	2.31	3.15	0.65	73.55	31.17	180	610.51
2	6.09	4.39	3.43	4.50	0.74	36.7	63.61	175	651.24
3	4.67	3.77	2.37	3.46	0.74	52.26	37.60	179	684.74
4	3.54	2.58	1.58	2.43	0.68	86.84	18.50	176	690.10
5	5.19	2.71	2.30	2.41	0.61	83.26	18.24	181	709.14
6	4.29	2.34	1.54	2.49	0.58	119.04	19.47	185	754.12
7	5.93	2.90	2.10	3.30	0.55	97.37	34.21	181	780.10
8	6.05	4.39	3.14	4.36	0.72	43.89	59.72	178	779.4
9	4.46	3.72	2.52	3.47	0.77	47.57	37.82	177	760.14
10	3.66	4.07	2.54	3.35	0.93	35.40	35.25	181	780.14
<b>Range</b>	2.55	2.05	1.80	2.09	0.38	83.64	45.37	10.0	169.6
<b>Mean</b>	4.86	3.37	2.38	3.29	0.69	67.59	35.56	179.30	720.0
<b>S.D.</b>	0.93	0.78	0.59	0.734	0.11	28.62	15.81	2.95	60.1
<b>CV, %</b>	19.23	23.17	24.87	22.29	15.80	42.35	44.47	1.64	8.35

## Appendix – III

## Physical properties of ginger

Sl. No	Size (cm)			Geometric mean, dia, (cm)	Sphericity	Rhizome index	Surface area (cm <sup>2</sup> )	Bulk volume (cm <sup>3</sup> )	Bulk density (kg m <sup>-3</sup> )
	Length	Width	Thickness						
1	12.30	9.20	3.55	9.37	0.59	37.66	170.64	210	489.80
2	16.10	8.30	4.80	8.62	0.53	40.41	233.43	214	492.90
3	20.10	13.00	3.20	9.40	0.46	48.31	277.59	209	485.00
40	21.50	8.50	4.60	9.43	0.43	54.95	279.36	213	479.80
5	16.20	10.00	3.95	8.61	0.53	41.01	232.89	220	507.90
6	18.20	12.00	3.89	9.47	0.52	38.98	281.74	217	499.21
7	15.15	7.50	3.91	7.63	0.50	51.66	182.89	201	482.30
8	19.30	9.50	4.12	9.10	0.47	49.31	260.15	219	493.50
9	9.10	8.50	4.31	6.93	0.76	24.83	150.87	205	488.34
10	17.20	11.00	4.51	9.48	0.55	34.67	282.33	204	499.50
<b>Range</b>	<b>12.40</b>	<b>5.50</b>	<b>1.60</b>	<b>2.55</b>	<b>0.32</b>	<b>30.12</b>	<b>131.50</b>	<b>19.00</b>	<b>28.10</b>
<b>Mean</b>	<b>16.52</b>	<b>9.75</b>	<b>4.08</b>	<b>8.80</b>	<b>0.53</b>	<b>42.18</b>	<b>235.20</b>	<b>211.20</b>	<b>491.82</b>
<b>S.D.</b>	<b>3.71</b>	<b>1.76</b>	<b>0.49</b>	<b>0.88</b>	<b>0.09</b>	<b>9.03</b>	<b>50.30</b>	<b>6.53</b>	<b>8.65</b>
<b>CV, %</b>	<b>22.44</b>	<b>18.06</b>	<b>12.01</b>	<b>10.03</b>	<b>16.95</b>	<b>21.41</b>	<b>21.39</b>	<b>3.09</b>	<b>1.76</b>

## Appendix – IV

## Physical properties of turmeric

Sl. No	Size (cm)			Geometric mean, dia, (cm)	Sphericity	Rhizome index (%)	Surface area (cm <sup>2</sup> )	Bulk volume (cm <sup>3</sup> )	Bulk density (kg m <sup>-3</sup> )
	Length	Width	Thickness						
1	17.27	14.23	3.10	9.13	0.52	39.14	261.87	185	445.80
2	19.31	11.50	3.50	9.19	0.47	47.90	265.39	191	432.90
3	9.25	12.40	4.20	7.83	0.84	17.76	192.60	196	484.00
4	13.27	10.40	4.05	8.23	0.62	31.50	212.78	200	479.80
5	9.50	6.50	3.50	6.00	0.63	41.75	113.09	204	510.90
6	12.20	8.10	4.10	7.39	0.60	36.73	171.56	189	489.21
7	14.50	9.20	3.80	7.97	0.54	41.47	199.55	187	472.30
8	15.38	10.04	3.50	8.14	0.52	43.76	208.16	201	493.50
9	14.23	9.80	2.80	7.30	0.51	51.85	167.41	204	498.34
10	13.47	9.12	3.10	7.20	0.53	47.64	162.86	185	509.50
<b>Range</b>	<b>10.06</b>	<b>7.73</b>	<b>1.40</b>	<b>3.19</b>	<b>0.37</b>	<b>34.09</b>	<b>152.3</b>	<b>19.0</b>	<b>78.0</b>
<b>Mean</b>	<b>13.83</b>	<b>10.12</b>	<b>3.56</b>	<b>7.83</b>	<b>0.578</b>	<b>39.95</b>	<b>195.20</b>	<b>194.20</b>	<b>481.63</b>
<b>S.D</b>	<b>3.12</b>	<b>2.19</b>	<b>0.47</b>	<b>0.94</b>	<b>0.10</b>	<b>9.77</b>	<b>45.9</b>	<b>7.70</b>	<b>25.53</b>
<b>CV, %</b>	<b>22.56</b>	<b>21.63</b>	<b>13.26</b>	<b>12.05</b>	<b>18.27</b>	<b>24.45</b>	<b>23.49</b>	<b>3.96</b>	<b>5.30</b>

## Appendix – V

## Coefficient of friction of tuber/rhizome

Sl. No.	Coefficient of friction								
	Stainless steel			Plywood			GI		
	Coleus	Ginger	Turmeric	Coleus	Ginger	Turmeric	Coleus	Ginger	Turmeric
1	0.60	0.53	0.53	0.78	0.66	0.73	0.71	0.56	0.64
2	0.72	0.51	0.54	0.79	0.61	0.74	0.74	0.58	0.69
3	0.74	0.52	0.59	0.87	0.54	0.72	0.73	0.59	0.71
4	0.78	0.49	0.61	0.83	0.51	0.79	0.75	0.48	0.66
5	0.67	0.45	0.58	0.81	0.50	0.78	0.69	0.50	0.61
<b>Range</b>	0.18	0.08	0.08	0.09	0.16	0.07	0.06	0.11	0.10
<b>Mean</b>	0.702	0.50	0.57	0.816	0.564	0.75	0.72	0.542	0.66
<b>S.D</b>	0.069	0.031	0.033	0.035	0.068	0.031	0.024	0.049	0.039
<b>CV,%</b>	9.89	6.32	5.95	4.38	12.19	4.14	3.33	9.08	5.99

## Appendix – VI

## Angle of repose and firmness of tuber/rhizome

Sl. No.	Angle of repose (degree)			Firmness (N)		
	Coleus	Ginger	Turmeric	Coleus	Ginger	Turmeric
1	38.14	31.69	28.74	248.69	163.44	81.48
2	38.59	33.77	29.47	296.35	277.96	59.67
3	39.05	35.08	31.58	187.26	193.23	60.95
4	34.10	36.40	33.14	198.36	257.79	71.57
5	38.14	34.75	35.51	235.23	178.63	65.47
<b>Range</b>	4.95	4.71	6.77	109.10	114.5	21.81
<b>Mean</b>	37.60	34.33	31.69	233.20	214.2	67.83
<b>S.D</b>	1.95	1.754	2.754	43.50	50.60	8.94
<b>C.V</b>	5.30	5.11	8.69	18.64	23.63	13.18

## Appendix - VII

## Draft, Digging Efficiency, Per Cent Damage and Fuel Consumption for Coleus

Sl. No.	Type of Blade	Rake angle (°)	Forward speed (km h <sup>-1</sup> )	Draft (N)	Digging efficiency (%)	Damage of Rhizome /tuber (%)	Fuel consumption (L h <sup>-1</sup> )
1.	Straight edge	15	1.5	1808.43	84.15	4.15	4.51
2.	V-type	15	1.5	1880.36	95.20	2.54	3.81
3.	Crescent type	15	1.5	1807.34	86.60	4.12	4.15
4.	Straight edge	20	1.5	1848.83	87.02	4.17	4.61
5.	V-type	20	1.5	1761.99	96.98	2.15	3.94
6.	Crescent type	20	1.5	1787.86	89.67	4.90	4.27
7.	Straight edge	25	1.5	1781.49	85.63	5.03	4.84
8.	V-type	25	1.5	1825.44	97.84	1.01	4.08
9.	Crescent type	25	1.5	1862.07	93.57	5.50	4.31
10.	Straight edge	15	2.0	1704.64	87.58	4.30	4.52
11.	V-type	15	2.0	1558.37	95.83	2.80	3.80
12.	Crescent type	15	2.0	1729.82	90.03	4.60	4.29
13.	Straight edge	20	2.0	1789.98	91.25	4.50	4.95
14.	V-type	20	2.0	1486.88	98.57	0.59	3.93
15.	Crescent type	20	2.0	1670.21	94.47	4.80	4.36
16.	Straight edge	25	2.0	1790.68	89.91	4.25	4.87
17.	V-type	25	2.0	1471.23	95.51	1.10	3.90
18.	Crescent type	25	2.0	1644.23	92.63	5.12	4.30
19.	Straight edge	15	2.5	1719.34	91.40	4.55	4.50
20.	V-type	15	2.5	1765.80	95.67	3.10	3.90
21.	Crescent type	15	2.5	1834.94	89.13	4.09	4.29
22.	Straight edge	20	2.5	1854.74	91.09	4.73	4.80
23.	V-type	20	2.5	1627.19	97.13	2.20	4.13
24.	Crescent type	20	2.5	1775.68	91.43	4.50	4.50
25.	Straight edge	25	2.5	1797.84	93.99	4.40	4.97
26.	V-type	25	2.5	1696.49	97.05	3.00	4.05
27.	Crescent type	25	2.5	1850.45	96.81	4.10	4.50
28.	Straight type	15	1.5	1786.64	86.25	4.20	4.44
29.	V-type	15	1.5	1867.54	95.77	3.04	4.18
30.	Crescent type	15	1.5	1810.97	87.66	4.20	4.25
31.	Straight edge	20	1.5	1844.20	85.17	4.18	4.7
32.	V-type	20	1.5	2009.52	96.54	2.16	3.85
33.	Crescent type	20	1.5	1801.35	89.79	4.84	4.30
34.	Straight edge	25	1.5	1765.38	87.54	5.09	4.80
35.	V-type	25	1.5	1774.14	97.99	2.02	4.05
36.	Crescent type	25	1.5	1779.71	89.52	5.12	4.51
37.	Straight edge	15	2.0	1766.95	87.59	4.36	4.50
38.	V-type	15	2.0	1556.29	93.80	1.10	4.07
39.	Crescent type	15	2.0	1731.61	90.06	3.40	4.05
40.	Straight edge	20	2.0	1748.67	88.25	4.58	4.81

---

41.	V-type	20	2.0	1418.66	98.02	1.84	3.98
42.	Crescent type	20	2.0	1650.15	92.82	3.90	4.30
43.	Straight edge	25	2.0	1724.63	89.77	4.50	4.90
44.	V-type	25	2.0	1496.59	96.04	2.25	4.14
45.	Crescent type	25	2.0	1722.80	93.91	4.70	4.50
46.	Straight edge	15	2.5	1800.95	91.19	4.14	4.43
47.	V-type	15	2.5	1764.98	96.06	2.92	4.10
48.	Crescent type	15	2.5	1828.55	89.30	4.09	4.20
49.	Straight edge	20	2.5	1865.44	87.92	3.90	4.60
50.	V-type	20	2.5	1572.13	98.04	2.23	4.19
51.	Crescent type	20	2.5	1748.85	99.32	4.10	4.30
52.	Straight edge	25	2.5	1715.45	92.78	4.20	4.98
53.	V-type	25	2.5	1757.58	95.84	2.94	4.10
54.	Crescent type	25	2.5	1901.66	92.04	5.50	4.50
55.	Straight edge	15	1.5	1823.93	87.98	4.18	4.53
56.	V-type	15	1.5	1876.92	95.78	3.17	3.90
57.	Crescent type	15	1.5	1820.03	88.50	4.09	4.20
58.	Straight edge	20	1.5	1860.40	90.64	3.80	4.83
59.	V-type	20	1.5	1975.57	98.07	2.14	3.97
60.	Crescent type	20	1.5	1768.92	93.64	5.24	4.33
61.	Straight edge	25	1.5	1821.75	86.07	4.93	4.92
62.	V-type	25	1.5	1753.62	98.35	1.99	4.11
63.	Crescent type	25	1.5	1895.02	93.39	5.18	4.43
64.	Straight edge	15	2.0	1782.23	90.05	4.28	4.58
65.	V-type	15	2.0	1595.93	96.92	2.56	3.93
66.	Crescent type	15	2.0	1732.32	92.48	4.58	4.25
67.	Straight edge	20	2.0	1726.75	93.85	4.47	4.86
68.	V-type	20	2.0	1431.37	99.89	0.98	4.05
69.	Crescent type	20	2.0	1720.01	91.20	4.70	4.40
70.	Straight edge	25	2.0	1677.10	92.25	4.80	4.90
71.	V-type	25	2.0	1501.08	98.18	1.99	4.11
72.	Crescent type	25	2.0	1744.21	97.10	4.98	4.48
73.	Straight edge	15	2.5	1841.47	90.68	4.43	4.59
74.	V-type	15	2.5	1804.65	94.72	3.46	3.98
75.	Crescent type	15	2.5	1812.58	93.22	4.08	4.29
76.	Straight edge	20	2.5	1821.72	89.54	4.68	4.94
77.	V-type	20	2.5	1590.10	95.56	2.04	4.10
78.	Crescent type	20	2.5	1762.77	96.07	5.16	4.47
79.	Straight edge	25	2.5	1830.79	92.99	5.18	4.87
80.	V-type	25	2.5	1782.01	96.57	2.98	4.18
81.	Crescent type	25	2.5	1901.31	94.14	5.39	4.50

---



## Appendix – VIII

## Draft, Digging efficiency, Per cent Damage and Fuel consumption for Ginger

Sl. No.	Type of Blade	Rake angle (°)	Forward speed (km h <sup>-1</sup> )	Draft (N)	Digging efficiency (%)	Per cent Damage (%)	Fuel consumption (L h <sup>-1</sup> )
1.	Straight edge	15	1.5	2001.20	80.86	5.48	4.53
2.	V-type	15	1.5	1431.57	93.92	3.10	3.99
3.	Crescent type	15	1.5	1901.53	83.92	5.78	4.20
4.	Straight edge	20	1.5	2010.30	81.94	4.18	4.83
5.	V-type	20	1.5	1615.79	97.20	2.15	3.94
6.	Crescent type	20	1.5	2001.59	87.37	4.12	4.33
7.	Straight edge	25	1.5	2090.61	81.41	4.03	4.92
8.	V-type	25	1.5	1780.31	98.06	2.01	4.08
9.	Crescent type	25	1.5	2014.08	91.16	3.99	4.43
10.	Straight edge	15	2.0	2010.50	83.07	5.30	4.58
11.	V-type	15	2.0	1460.68	95.85	1.15	3.93
12.	Crescent type	15	2.0	1954.23	86.19	5.03	4.25
13.	Straight edge	20	2.0	2050.60	87.45	3.51	4.86
14.	V-type	20	2.0	1625.82	98.84	0.86	4.03
15.	Crescent type	20	2.0	2019.14	91.50	3.80	4.40
16.	Straight edge	25	2.0	2098.71	85.98	3.50	4.96
17.	V-type	25	2.0	1801.14	99.25	0.98	4.11
18.	Crescent type	25	2.0	2018.04	89.55	3.60	4.48
19.	Straight edge	15	2.5	2019.34	85.75	5.55	4.59
20.	V-type	15	2.5	1467.78	95.48	1.39	3.95
21.	Crescent type	15	2.5	1970.56	84.88	6.05	4.29
22.	Straight edge	20	2.5	2070.15	85.18	3.75	4.94
23.	V-type	20	2.5	1630.92	97.91	1.15	4.10
24.	Crescent type	20	2.5	2021.50	92.94	4.15	4.47
25.	Straight edge	25	2.5	2101.14	89.59	3.74	5.06
26.	V-type	25	2.5	1850.08	98.15	1.89	4.18
27.	Crescent type	25	2.5	2019.18	91.00	3.86	4.50
28.	Straight edge	15	1.5	1955.37	83.39	5.32	4.47
29.	V-type	15	1.5	1374.31	91.81	3.195	3.84
30.	Crescent type	15	1.5	1887.27	80.80	5.46	4.15
31.	Straight edge	20	1.5	1997.23	82.73	4.14	4.78
32.	V-type	20	1.5	1608.52	95.96	2.13	3.90
33.	Crescent type	20	1.5	2003.59	86.71	4.19	4.27
34.	Straight edge	25	1.5	2176.33	85.77	3.93	4.93
35.	V-type	25	1.5	1729.57	92.49	1.99	4.16
36.	Crescent type	25	1.5	2012.07	89.05	3.96	4.31
37.	Straight edge	15	2.0	2058.75	81.93	5.20	4.52
38.	V-type	15	2.0	1477.84	96.02	1.14	3.74
39.	Crescent type	15	2.0	1937.62	85.76	4.97	4.29
40.	Straight edge	20	2.0	2074.85	86.07	3.43	5.06

---

41 V-type	20	2.0	1624.19	99.57	0.85	3.93
42 Crescent type	20	2.0	2090.31	87.88	3.93	4.46
43 Straight edge	25	2.0	2163.25	87.64	3.53	4.95
44 V-type	25	2.0	1795.29	98.23	0.97	3.97
45 Crescent type	25	2.0	2019.05	88.15	3.51	4.39
46 Straight edge	15	2.5	2100.11	81.93	5.49	4.62
47 V-type	15	2.5	1523.56	97.04	1.44	3.90
48 Crescent type	15	2.5	2013.42	87.44	6.10	4.29
49 Straight edge	20	2.5	2088.26	85.40	3.77	4.99
50 V-type	20	2.5	1674.95	98.65	1.18	4.13
51 Crescent type	20	2.5	2023.02	87.44	4.16	4.57
52 Straight edge	25	2.5	2130.14	85.05	3.70	5.10
53 V-type	25	2.5	1826.03	98.75	1.95	4.05
54 Crescent type	25	2.5	2026.75	89.42	3.97	4.50
55 Straight edge	15	1.5	2012.66	81.53	5.49	4.54
56 V-type	15	1.5	1445.89	94.76	3.13	4.18
57 Crescent type	15	1.5	1920.55	85.17	5.81	4.25
58 Straight edge	20	1.5	2062.57	84.70	4.24	4.89
59 V-type	20	1.5	1625.48	94.02	2.16	3.83
60 Crescent type	20	1.5	2000.09	89.01	4.10	4.34
61 Straight edge	25	1.5	2026.32	87.51	4.05	4.85
62 V-type	25	1.5	1847.96	97.29	2.086	4.05
63 Crescent type	25	1.5	2008.04	83.77	3.90	4.51
64 Straight edge	15	2.0	1998.44	83.53	5.30	4.56
65 V-type	15	2.0	1392.03	95.97	1.12	4.07
66 Crescent type	15	2.0	2020.67	84.69	5.01	4.05
67 Straight edge	20	2.0	2123.35	82.61	3.60	4.91
68 V-type	20	2.0	1632.32	98.14	0.87	4.05
69 Crescent type	20	2.0	1924.24	90.46	3.69	4.35
70 Straight edge	25	2.0	2012.66	81.82	3.36	4.94
71 V-type	25	2.0	1783.58	98.87	0.96	4.14
72 Crescent type	25	2.0	2021.07	93.04	3.57	4.50
73 Straight edge	15	2.5	1999.15	80.40	5.56	4.46
74 V-type	15	2.5	1453.84	94.86	1.37	4.12
75 Crescent type	15	2.5	1984.85	83.86	5.91	4.29
76 Straight edge	20	2.5	2124.49	85.10	3.71	4.72
77 V-type	20	2.5	1619.91	99.05	1.12	4.19
78 Crescent type	20	2.5	2015.44	89.01	4.20	4.32
79 Straight edge	25	2.5	2093.89	86.35	3.62	5.19
80 V-type	25	2.5	1868.12	99.08	1.91	4.13
81 Crescent type	25	2.5	1988.89	89.87	3.77	4.52

---

## Appendix – IX

## Draft, Digging efficiency, Per cent Damage and Fuel consumption for Turmeric

Sl. No.	Type of Blade	Rake angle (°)	Forward speed (km h <sup>-1</sup> )	Draft(N)	Digging efficiency (%)	Per cent Damage (%)	Fuel consumption (L h <sup>-1</sup> )
1.	Straight edge	15	1.5	2016.95	82.21	6.73	4.53
2.	V-type	15	1.5	1447.32	95.27	4.35	4.21
3.	Crescent type	15	1.5	1917.28	85.27	7.03	5.20
4.	Straight edge	20	1.5	2026.05	83.29	5.43	4.83
5.	V-type	20	1.5	1631.54	98.55	3.40	4.20
6.	Crescent type	20	1.5	2017.34	88.72	5.37	5.12
7.	Straight edge	25	1.5	2106.36	82.76	5.28	4.92
8.	V-type	25	1.5	1796.06	99.14	3.26	4.44
9.	Crescent type	25	1.5	2029.83	92.51	5.24	5.21
10.	Straight edge	15	2.0	2026.25	84.42	6.55	4.56
11.	V-type	15	2.0	1476.43	97.20	2.40	4.12
12.	Crescent type	15	2.0	1969.98	87.54	6.28	5.25
13.	Straight edge	20	2.0	2066.35	88.80	4.76	4.87
14.	V-type	20	2.0	1641.57	99.19	1.12	4.03
15.	Crescent type	20	2.0	2034.89	92.85	5.05	5.19
16.	Straight edge	25	2.0	2114.46	87.33	4.75	4.96
17.	V-type	25	2.0	1816.89	99.10	2.23	4.11
18.	Crescent type	25	2.0	2033.79	90.90	4.85	5.36
19.	Straight edge	15	2.5	2035.09	87.10	6.80	4.59
20.	V-type	15	2.5	1483.53	96.83	2.64	4.34
21.	Crescent type	15	2.5	1986.31	86.23	7.30	5.29
22.	Straight edge	20	2.5	2085.90	86.53	5.00	4.93
23.	V-type	20	2.5	1646.67	99.26	2.40	4.30
24.	Crescent type	20	2.5	2037.25	94.29	5.40	5.25
25.	Straight edge	25	2.5	2116.89	90.94	4.99	5.04
26.	V-type	25	2.5	1865.83	99.08	3.14	4.10
27.	Crescent type	25	2.5	2034.93	92.35	5.11	5.19
28.	Straight edge	15	1.5	1971.12	84.74	6.57	4.50
29.	V-type	15	1.5	1390.06	93.16	4.44	4.23
30.	Crescent type	15	1.5	1903.02	82.15	6.71	5.04
31.	Straight edge	20	1.5	2012.98	84.08	5.39	4.82
32.	V-type	20	1.5	1624.27	97.31	3.38	4.19
33.	Crescent type	20	1.5	2019.34	88.06	5.44	4.89
34.	Straight edge	25	1.5	2192.08	87.12	5.18	5.01
35.	V-type	25	1.5	1745.32	93.84	3.24	4.44
36.	Crescent type	25	1.5	2027.82	90.40	5.21	5.06
37.	Straight edge	15	2.0	2074.50	83.09	6.45	4.61
38.	V-type	15	2.0	1493.59	97.10	2.39	4.13
39.	Crescent type	15	2.0	1953.37	86.91	6.22	5.19
40.	Straight edge	20	2.0	2090.60	87.22	4.57	4.72

---

41.	V-type	20	2.0	1639.94	99.40	0.74	4.00
42.	Crescent type	20	2.0	2106.06	89.03	5.07	5.07
43.	Straight edge	25	2.0	2179.00	88.79	4.67	4.95
44.	V-type	25	2.0	1811.04	98.70	1.47	4.27
45.	Crescent type	25	2.0	2034.80	89.30	4.656	5.57
46.	Straight edge	15	2.5	2115.86	83.00	6.636	4.55
47.	V-type	15	2.5	1539.31	98.19	2.586	4.32
48.	Crescent type	15	2.5	2029.17	88.60	7.24	5.32
49.	Straight edge	20	2.5	2104.01	86.55	4.91	5.01
50.	V-type	20	2.5	1690.70	99.50	2.32	4.19
51.	Crescent type	20	2.5	2038.77	88.59	5.30	5.06
52.	Straight edge	25	2.5	2145.89	86.20	4.84	4.99
53.	V-type	25	2.5	1841.78	99.00	3.09	4.29
54.	Crescent type	25	2.5	2042.50	90.57	5.11	5.19
55.	Straight edge	15	1.5	2028.41	82.68	6.63	4.63
56.	V-type	15	1.5	1461.64	95.91	4.27	4.17
57.	Crescent type	15	1.5	1936.30	86.32	6.95	5.14
58.	Straight edge	20	1.5	2078.32	85.86	5.38	4.80
59.	V-type	20	1.5	1641.23	95.18	3.30	4.12
60.	Crescent type	20	1.5	2015.84	90.16	5.24	5.28
61.	Straight edge	25	1.5	2042.07	88.66	5.19	4.89
62.	V-type	25	1.5	1863.71	98.44	3.23	4.44
63.	Crescent type	25	1.5	2023.79	84.90	5.04	5.24
64.	Straight edge	15	2.0	2014.19	84.68	6.44	4.34
65.	V-type	15	2.0	1407.78	97.12	2.26	4.04
66.	Crescent type	15	2.0	2036.42	85.84	6.15	5.23
67.	Straight edge	20	2.0	2139.10	83.76	4.74	5.05
68.	V-type	20	2.0	1648.07	99.01	1.14	4.03
69.	Crescent type	20	2.0	1939.99	91.62	4.836	5.15
70.	Straight edge	25	2.0	2028.41	82.98	4.506	4.93
71.	V-type	25	2.0	1799.33	99.00	0.97	4.06
72.	Crescent type	25	2.0	2036.82	94.20	4.71	5.30
73.	Straight edge	15	2.5	2014.90	81.91	6.70	4.48
74.	V-type	15	2.5	1469.59	96.37	2.51	4.33
75.	Crescent type	15	2.5	2000.60	85.37	7.05	5.30
76.	Straight edge	20	2.5	2140.24	86.61	4.85	4.82
77.	V-type	20	2.5	1635.66	99.30	2.26	4.30
78.	Crescent type	20	2.5	2031.19	90.52	5.34	5.49
79.	Straight edge	25	2.5	2109.64	87.86	4.76	4.90
80.	V-type	25	2.5	1883.87	98.30	3.05	4.05
81.	Crescent type	25	2.5	2004.64	91.38	4.91	5.16

---

**Appendix – X****Conveying efficiency and soil separation index of the root crop harvester on coleus**

<b>Sl. No</b>	<b>Diameter of crank (cm)</b>	<b>Spring tension (N m<sup>-1</sup>)</b>	<b>Conveying efficiency (%)</b>	<b>Soil separation index (%)</b>
1	4	800	82.59	74.59
2	6	800	84.10	76.10
3	8	800	85.02	77.02
4	4	1200	87.54	79.54
5	6	1200	88.38	80.38
6	8	1200	89.62	81.62
7	4	1600	87.06	79.06
8	6	1600	88.90	80.90
9	8	1600	89.72	81.72
10	4	800	79.10	71.10
11	6	800	82.78	74.78
12	8	800	84.50	76.50
13	4	1200	87.77	75.77
14	6	1200	90.70	82.71
15	8	1200	87.53	79.53
16	4	1600	85.93	77.93
17	6	1600	87.14	79.14
18	8	1600	89.30	81.31
19	4	800	85.20	77.20
20	6	800	83.66	75.66
21	8	800	84.84	76.84
22	4	1200	86.58	78.58
23	6	1200	86.63	78.63
24	8	1200	88.92	80.92
25	4	1600	88.56	80.56
26	6	1600	88.31	80.31
27	8	1600	89.82	81.82

## Appendix – XI

## Conveying efficiency and soil separation index of the root crop harvester on ginger

<b>Sl. No</b>	<b>Diameter of crank (cm)</b>	<b>Spring tension (N m<sup>-1</sup>)</b>	<b>Conveying efficiency (%)</b>	<b>Soil separation index (%)</b>
1	4	800	79.44	64.59
2	6	800	80.95	66.10
3	8	800	81.87	67.02
4	4	1200	84.39	69.54
5	6	1200	85.23	70.38
6	8	1200	86.47	71.62
7	4	1600	83.91	69.06
8	6	1600	85.75	70.90
9	8	1600	86.57	71.72
10	4	800	75.95	61.60
11	6	800	79.63	65.28
12	8	800	81.35	67.00
13	4	1200	84.62	66.27
14	6	1200	87.55	73.21
15	8	1200	84.38	70.03
16	4	1600	82.78	68.43
17	6	1600	84.39	69.64
18	8	1600	86.55	71.81
19	4	800	82.45	67.08
20	6	800	80.91	65.54
21	8	800	82.09	66.72
22	4	1200	83.83	68.46
23	6	1200	83.88	68.51
24	8	1200	86.17	70.80
25	4	1600	85.81	70.44
26	6	1600	85.56	70.19
27	8	1600	87.07	71.70

### Appendix – XII

#### Conveying efficiency and soil separation index of the root crop harvester on turmeric

<b>Sl. No.</b>	<b>Diameter of crank (cm)</b>	<b>Spring tension (N m<sup>-1</sup>)</b>	<b>Conveying efficiency (%)</b>	<b>Soil separation index (%)</b>
1	4	800	79.48	60.59
2	6	800	81.99	61.10
3	8	800	82.91	62.02
4	4	1200	85.43	64.54
5	6	1200	85.27	65.38
6	8	1200	89.51	66.62
7	4	1600	84.95	62.06
8	6	1600	86.79	65.90
9	8	1600	87.61	66.72
10	4	800	76.99	60.10
11	6	800	80.67	59.78
12	8	800	82.39	61.50
13	4	1200	85.66	60.77
14	6	1200	88.59	67.70
15	8	1200	85.42	66.53
16	4	1600	83.82	62.93
17	6	1600	85.03	64.14
18	8	1600	87.19	66.31
19	4	800	83.09	62.20
20	6	800	81.55	63.66
21	8	800	82.73	61.84
22	4	1200	84.47	63.58
23	6	1200	85.52	63.63
24	8	1200	86.81	66.92
25	4	1600	85.45	63.56
26	6	1600	86.20	65.31
27	8	1600	89.71	68.82

**Appendix -XIII**

**Mean and Co-efficient of variation for the operational parameters of the root  
crop harvester for coleus, ginger and turmeric**

S. No.	Operational parameter	Mean			Co-efficient of variation		
		Coleus	Ginger	Turmeric	Coleus	Ginger	Turmeric
1.	Draft (N)	1753.0	1894.25	1910.00	2.75	1.94	1.92
2.	Digging efficiency (%)	92.76	89.65	90.78	1.99	1.99	1.97
3.	Per cent damage (%)	3.77	3.47	4.61	11.29	6.30	5.74
4.	Fuel consumption (l h <sup>-1</sup> )	4.36	4.40	4.47	2.01	1.95	2.01
5.	Conveying efficiency (%)	86.67	83.69	84.64	1.52	1.62	1.69
6.	Soil separation index (%)	78.53	68.66	63.86	1.84	1.94	2.22



### Appendix – XIV

#### Economic evaluation of developed root crop harvester

The cost of operation has been worked out based on the following assumptions.

#### Assumptions made,

Initial cost of tractor, Rs.	= 8, 00,000
Initial cost of root crop harvester	= 60,000
Annual usage for tractor, h	= 1,000
Actual daily usage, h day <sup>-1</sup>	= 8
Annual usage of root crop harvester, h	= 250
Total life of tractor, years	= 10
Total life of root crop harvester, year	= 7
Salvage value (10 % of initial cost of tractor), Rs	= 80,000
Salvage value (10 % of initial cost of root crop harvester), Rs	= 6,000

#### A. Fixed cost of tractor drawn root crop harvester

Sl. No.	Annual fixed cost	Tractor		Root crop harvester	
		Annual	Per hour	Annual	Per hour
1	Depreciation, Rs	$(800000 - 80000)/10 = 72000$	72.00	$(60000 - 6000)/7 = 7714$	30.85
2	Interest, Rs	$(800000 + 80000)/2 \times 10/100 = 44000$	44.00	$(60000 + 6000)/2 \times 10/100 = 3300$	13.20
3	Housing, @ 1.5% of purchase cost, Rs.	12000	12.00	900	3.60
4	Taxes @ 1 % of average price, Rs	8000	8.00	-	-
5	Insurance, @ 1 % of initial cost	$(800000 + 80000)/2 \times 1/100 = 4400$	4.40	$(60000 + 6000)/2 \times 1/100 = 330$	1.32
6	Repair and maintenance @ 8 % of purchase cost, Rs	$800000 \times 8/100 = 64000$	64.00	$60000 \times 8/100 = 4800$	19.20
7	Total fixed cost, Rs. h <sup>-1</sup>	204400	204.40	17044	68.17
8	Annual fixed cost, Rs.	$204.40 \times 250 = 51100$		17044	

**B. Variable cost of tractor drawn root crop harvester**

1	Operator wages @18000/ month Rs. h <sup>-1</sup>	75	-	-
2	Fuel cost @ Rs 70 l <sup>-1</sup> 5.0 l h <sup>-1</sup>	350	-	-
3	Lubrication @ 20 % of fuel cost, Rs	70	-	-
4	Total operating cost, Rs	-	495	

**C. Total cost per hour, Rs** = 204.40 + 68.17 + 495.00  
= 767.57

**D. Cost per ha**

Field capacity, ha h<sup>-1</sup> = 0.16

Cost of operation, Rs. ha<sup>-1</sup> = 767.57/0.16 = 4797.31

Cost of collection and bagging (60labours per ha @ 750 day<sup>-1</sup>), Rs. ha<sup>-1</sup> = 45000

Total cost of harvesting, Rs. ha<sup>-1</sup> = 4797.31+45000 = 49797

**E. Cost of harvesting by conventional method**

Area of field harvested by skilled labour in one day = 0.025 ha  
(3 labours used)

Total labours required ha<sup>-1</sup> = 120

Wages of labour per day, Rs = 750

Cost of harvesting, Rs. ha<sup>-1</sup> = 90000

**F. Saving in labour**

Total labours required to harvest one ha.  
with root crop harvester = 61

Total labours required to harvest one ha  
with conventional harvesting = 120

Saving in labour, % = 50.8%

**G. Saving in cost**

Cost of operation of harvester without collection and bagging	= 4797.31
Cost of digging by manual (60 labours required for ha)	= 45000
Saving in cost without collection, per cent	= <b>89</b>
Cost of harvesting using harvester	= 49797
Cost by manual harvesting, Rs	= 90000
Saving in cost	= 90000-49797
	= 40203
Saving in cost, per cent	= <b>44.67</b>

**H. Break Even Point**

$$\text{BEP} = \frac{\text{AFC}}{\text{CF} - \text{C}}$$

Where,

BEP	=	Break-even point, h yr <sup>-1</sup>
AFC	=	Annual fixed cost for the machine, Rs. yr <sup>-1</sup>
CF	=	Custom fee, Rs. h <sup>-1</sup>
C	=	Operating cost, Rs. h <sup>-1</sup>
CF	=	(cost of operation h <sup>-1</sup> + 25 per cent overhead charges) + (25 per cent profit over new cost)
Annual fixed cost, Rs. yr <sup>-1</sup>	=	Annual fixed cost of tractor + Annual fixed cost of harvester

$$= 51100 + 17044$$

$$= 68144$$

Custom fee, Rs. h<sup>-1</sup> = (Cost operation h<sup>-1</sup> + 25 per cent overhead charges) x (25 per cent profit over new cost)

$$= (767.57 + 767.57 \times 0.25) \times 1.25$$

$$= 1199.32$$

Operating cost, Rs. h<sup>-1</sup> = 495

Effective field capacity, ha h<sup>-1</sup> = 0.16

$$\text{BEP} = \frac{68144}{1199.32 - 495}$$

$$= 3.25 \text{ h per annum say } 4 \text{ h yr}^{-1}$$

Annual utility = Effective field capacity x Annual utility period

$$= 0.16 \times 250$$

$$= 40.00 \text{ ha}$$

Therefore, BEP is achieved about  $(4 \times 100) / 40.00 = 90$  per cent of the annual utility rate of 250 hours of the root crop harvester.

### I. Pay- back period

$$\text{PBP} = \frac{\text{IC}}{\text{ANP}}$$

Where,

PBP = Payback period, yr

IC = Initial cost of the machine, Rs

ANP = Average net annual profit, Rs yr<sup>-1</sup>

ANP = (CF - C) x AU

Where,

AU = Annual use, h yr<sup>-1</sup>

Initial cost of the harvester, Rs = (initial cost of tractor for 1000 h + initial cost of harvester

$$= (800000 \times 200) / 1000 + 60000$$

$$= 2, 20,000$$

Average net annual benefit, Rs. = (custom fee  $h^{-1}$  - Total cost of operation  $h^{-1}$ ) x  
Annual utility rate, h

$$= (1199.32 - 495.00) \times 250$$

$$= 176080$$

Therefore, payback period

$$= 220000/176080$$

$$= 1.24 \text{ years} \quad \text{say } 1.50 \text{ year}$$

#### **J. Benefit Cost Ratio**

Benefit cost per hectare = Cost of manual harvesting – Cost of machine harvesting

Therefore,

$$\text{Benefit cost ratio} = \frac{\text{Benefit cost}}{\text{Cost of machine harvesting}}$$

$$\text{Benefit cost per hectare, Rs. ha}^{-1} = 56250 - 4797 = 51453$$

$$\text{B: C ratio} = \frac{51453}{4797}$$

$$= 10.7$$

---

***ABSTRACT***

**INVESTIGATIONS ON SOIL, CROP AND MACHINE PARAMETERS  
TOWARDS THE DEVELOPMENT OF A ROOT CROP HARVESTER**

by

**BASAVARAJ**

**(2017-28-004)**

**ABSTRACT**

**of the thesis submitted in partial fulfilment of  
the requirement for the degree of**

**DOCTOR OF PHILOSOPHY  
IN  
AGRICULTURAL ENGINEERING**

**(Farm Power and Machinery)**

**Faculty of Agricultural Engineering and Technology  
Kerala Agricultural University**



**DEPARTMENT OF FARM MACHINERY AND POWER ENGINEERING  
KELAPPAJI COLLEGE OF AGRICULTURAL ENGINEERING AND  
TECHNOLOGY, TAVANUR – 679 573**

**KERALA, INDIA**

**2020**

## ABSTRACT

The tractor drawn root harvester was designed and developed by considering soil, crop and machine parameters and performance evaluation of the machine was carried out in the experimental area at KCAET, Tavanur and different farmers' fields at Palakkad and Thrissur districts. The developed machine mainly consists of main frame, power transmission system, digging and soil separator units. The effect of three blade geometries *viz.*, straight edge, V-type and crescent blades at three rake angles of 15, 20 and 25 deg. and at three forward speeds of 1.5, 2.0 and 2.5 km h<sup>-1</sup> for the digging unit of the harvester were evaluated in terms of draft, digging efficiency, per cent damage of tuber/rhizome and fuel consumption of tractor mounted harvester for harvesting coleus, ginger and turmeric. The best optimal condition was observed at a forward speed of 2.0 km h<sup>-1</sup> with 20 deg. rake angle for V-type blade. The soil separator unit of the harvester was evaluated along the digging operation. The soil separator unit was tested with different operational parameters *viz.*, diameter of crank 40, 60 and 80 mm and spring tension 800, 1200 and 1600 N m<sup>-1</sup>. The best optimal operational conditions were observed at a spring tension of 1600 N m<sup>-1</sup> with 80 mm diameter of crank. The maximum draft of 2009.52 N was recorded in straight blade while the minimum of 1418.66 N was observed in V-type blade. The maximum digging efficiency of 99.89 per cent was noticed in V-type blade, whereas the lowest of 84.15 per cent in straight edge blade. The least damage coleus of 0.59 per cent was observed in V-type blade whereas highest of 5.5 per cent was obtained in crescent blade. Among the different type of blades tested, the less fuel consumption of 3.80 l h<sup>-1</sup> was noticed for V-type blade, whereas the maximum of 4.98 l h<sup>-1</sup> for straight edge blade. In the case of harvesting ginger, the maximum draft of 2176.33 N was recorded in straight edge blade while the minimum of 1374.31 N was observed in V- type blade. The maximum digging efficiency of 99.57 per cent was noticed in V-type blade, whereas the lowest of 80.40 per cent in straight edge blade. The least damage coleus of 0.86 per cent was observed in V-type blade whereas highest of 6.05 per cent was obtained in crescent blade. Among the different type of blades, the less fuel consumption of 3.74 l h<sup>-1</sup> was noticed for V-type blade, whereas the maximum of 5.19 l h<sup>-1</sup> for straight edge blade. In the case of harvesting of turmeric, the maximum draft



of 2192.08 N was recorded in straight edge blade while the minimum of 1390.06 N was observed in V-type blade. The maximum digging efficiency of 99.50 per cent was noticed in V-type blade, whereas the lowest of 81.91 per cent was recorded with the straight edge blade. The least per cent damage coleus of 0.74 per cent was observed in V-type blade whereas highest of 7.3 per cent was obtained in crescent blade. Among the different type of blades, the less fuel consumption of  $4.0 \text{ l h}^{-1}$  was noticed for V-type blade, whereas the maximum of  $5.57 \text{ l h}^{-1}$  for straight edge blade. The field capacity of the machine for coleus, ginger and turmeric were 0.15, 0.16 and  $0.16 \text{ ha h}^{-1}$  respectively and the field efficiencies were 86.11, 88.89 and 88.89 per cent respectively. The soil separation indices of root crop harvester for coleus, ginger and turmeric were found out as 82.71, 73.22 and 68.82 per cent respectively where as the conveying efficiencies were 90.70, 87.55 and 89.71 per cent respectively. The estimated cost of the prototype tractor drawn root crop harvester was as Rs. 60,000. The cost of operation was found out as Rs. 767.57 per hour. The saving in cost over root crop harvester for three root crops was 89 per cent. The machine has BEP of 40 h, PBP as 1.5 years and BCR as 10.7.